

Edited by Michael A. Murphy¹ and Amos Salvador²

International Subcommittee on Stratigraphic Classification of IUGS International Commission on Stratigraphy International Stratigraphic Guide — An abridged version

1 Geology Department, University of California, Davis, California 95616, USA.

2 Department of Geological Sciences, University of Texas at Austin, Austin, Texas 78712, USA; e-mail: amos.salvador@mail.utexas.edu

Effective communication in science requires accurate and precise internationally acceptable terminology and procedures. The Abridged Version of the International Stratigraphic Guide, like the Guide itself, was developed to promote international agreement on principles of stratigraphic classification and to develop an internationally acceptable stratigraphic terminology and rules of procedure in the interest of improved accuracy and precision in international communication, coordination, and understanding. It is not a revision of the Guide but a short version that omits history, explanatory text, and exemplification, the glossaries and the bibliography.

Preface

The second edition of the *International Stratigraphic Guide*, edited by Amos Salvador, was prepared by the International Subcommittee on Stratigraphic Classification of the International Commission on Stratigraphy and co-published in 1994 by the International Union of Geological Sciences and the Geological Society of America. Like the first edition, edited by Hollis D. Hedberg and published in 1976, the second edition of the *Guide* has been widely accepted and used by stratigraphers throughout the world. Copies can be obtained from the Geological Society of America, Publication Sales, P.O. Box 9140, Boulder, CO 80301, Fax 303-447-1133.

Despite the wide acceptance and distribution of the second edition of the *Guide*, stratigraphers and students of stratigraphy around the world have commented on difficulty in gaining access to the *Guide* mainly because of remote availability of copies and of cost. The present abridged version of the second edition of the *Guide* is an attempt to overcome these problems.

This abridged version is not a revision of the substance of the *Guide*; all essential tenets of the full second edition concerning stratigraphic classification, terminology, and procedure have been retained. Moreover, the abridged version has maintained the same organizational framework to the level of chapters, headings, and subheadings, so that the user can readily refer to the full version of the *Guide* for supplementary detail; and where non-essential discussions of certain sections have been eliminated, headings have still been retained so that the user can easily find the corresponding section in the full version of the *Guide*. The principal victims of the abridgement have been some explanatory text, examples of stratigraphic procedures, the Glossary of Stratigraphic Terms, the List of

National or Regional Stratigraphic Codes, and the extensive Bibliography of Stratigraphic Classification, Terminology and Procedure.

The editors express their appreciation to the editor of *Episodes* for helping to meet the aims of this abridged version of the *International Stratigraphic Guide* by publishing it in his journal, and for agreeing to prepare and market covered reprints of this document at cost. These actions ensure that the basic tenets of stratigraphic classification, terminology, and procedure can now reach stratigraphers and students of stratigraphy everywhere in the world.

As the notice accompanying this issue of *Episodes* states, individual covered reprints of the abridged version of the second edition of the *Guide* can be obtained from *Episodes*, P.O. Box 823, 26 Baiwanzhuang Road, 100037 Beijing, People's Republic of China, for a few dollars plus postage charges.

CHAPTER 1 Introduction

A. Origin and Purposes of the *Guide*

The purposes and spirit of this short version are the same as those of the second edition of the *Guide*: to promote international agreement on principles of stratigraphic classification and to develop an internationally acceptable stratigraphic terminology and rules of stratigraphic procedure—all in the interest of improved accuracy and precision in international communication, coordination, and understanding.

B. Composition of Subcommittee

The membership of the Subcommittee represents a worldwide geographic spread of stratigraphers and stratigraphic organizations and a wide spectrum of stratigraphic interests, traditions and philosophies. Over the years, the number of members has ranged from 75 to 130 representing 30 to 45 countries.

C. Preparation and Revision of the *Guide*

D. Spirit of the *Guide*

Like the second edition of the *International Stratigraphic Guide*, this abridged version is offered as a recommended approach to stratigraphic classification, terminology, and procedure, not as a “code”.

E. National and Regional Stratigraphic Codes

The ISSC has always supported the development of national and regional stratigraphic codes; these codes have helped in the past

in developing principles, and providing a testing ground for various proposals contained in the Guide.

F. Alternative or Dissenting Views

CHAPTER 2 Principles of Stratigraphic Classification

A. General

Stratigraphic classification encompasses all rocks of the crust of the Earth. Rocks have many tangible and measurable properties and may be classified according to any of them. Rocks may also be classified by their time of origin or interpreted attributes, such as environment or genesis.

The stratigraphic position of change for any property or attribute does not necessarily coincide with that for any other. Consequently, units based on one property commonly do not coincide with those based on a different property. Therefore, it is not possible to express the distributions in the rocks of all of the different properties with a single set of stratigraphic units. Different sets of units are needed. However, all the different classifications are closely related because they express different aspects of the same rock bodies and they are used to achieve the same goals of stratigraphy: to improve our knowledge and understanding of the Earth's rock bodies and their history.

B. Categories of Stratigraphic Classification

Rock bodies may be classified according to many different inherent properties. Each classification needs its own distinctive nomenclature. The following kinds of formal units are best known and most widely used:

1. *Lithostratigraphic units*— units based on the lithologic properties of the rock bodies.
2. *Unconformity-bounded units*—bodies of rock bounded above and below by significant discontinuities in the stratigraphic succession.
3. *Biostratigraphic units*—units based on the fossil content of the rock bodies.
4. *Magnetostratigraphic polarity units*—units based on changes in the orientation of the remanent magnetization of the rock bodies.
5. *Chronostratigraphic units*— units based on the time of formation of the rock bodies.

Many other properties and attributes may be used to classify rock bodies and the way is open to use any that show promise. Whenever this is the case, the unit-terms being used should be defined.

Though each kind of stratigraphic unit may be particularly useful in stratigraphic classification under certain conditions or in certain areas or for certain purposes, chronostratigraphic units offer the greatest promise for formally-named units of worldwide application because they are based on their time of formation. Lithostratigraphic, biostratigraphic, and unconformity-bounded units are all of limited areal extent, and thus unsatisfactory for global synthesis. Magnetostratigraphic polarity units, though potentially worldwide in extent, require extrinsic data from the other units for their recognition, and dating. For these reasons, chronostratigraphic units have been chosen for international communication among stratigraphers with respect to position in the stratigraphic column.

C. Distinguishing Terminologies for each Category

Appropriate distinguishing terms are needed for each of the various categories of stratigraphic units. Some of the classifications

are best suited to a hierarchical classification whereas in others all categories are of equal rank. Table 1 gives terms here recommended for various categories of stratigraphic units.

Table 1 Summary of Categories and Unit-Terms in Stratigraphic Classification.*

Stratigraphic Categories	Principal Stratigraphic Unit-terms	Equivalent Geochronologic Units
Lithostratigraphic	Group Formation Member Bed(s), Flow(s)	
Unconformity-bounded	Synthem	
Biostratigraphic	Biozones: Range zones Interval zones Lineage zones Assemblage zones Abundance zones Other kinds of biozones	
Magnetostratigraphic polarity	Polarity zone	
Other (informal) stratigraphic categories (mineralogic, stable isotope, environmental, seismic, etc.)	-zone (with appropriate prefix)	
Chronostratigraphic	Eonothem Erathem System Series Stage Substage (Chronozone)	Eon Era Period Epoch Age Subage (or Age) (Chron)

*If additional ranks are needed, prefixes *Sub* and *Super* may be used with unit-terms when appropriate, although restraint is recommended to avoid complicating the nomenclature unnecessarily.

D. Chronostratigraphic and Geochronologic Units

Chronostratigraphic units are tangible stratigraphic units because they encompass all the rocks formed during a defined interval of time. Geochronologic units are units of time—an intangible property—and thus intangible units, not in themselves stratigraphic units.

E. Incompleteness of the Rock Record

The rock record of any one area is far from continuous or complete. It is commonly interrupted by innumerable diastems, discontinuities, and unconformities. Short interruptions of the record, in fact, exist in layered rocks at every bedding plane. The evidence which the rocks carry of these missing intervals is in itself a part of stratigraphy and a very important contribution to the understanding of Earth history.

CHAPTER 3 Definitions and Procedures

A. Definitions

1. **Stratigraphy.** Stratigraphy, from Latin *stratum* + Greek *graphia*, is the description of all rock bodies forming the Earth's crust and their organization into distinctive, useful, mappable units based on their inherent properties or attributes in order to establish their distribution and relationship in space and their succession in time, and to interpret geologic history.

2. **Stratum (plural=strata).** A layer of rock characterized by particular lithologic properties and attributes that distinguish it from adjacent layers.

3. **Stratigraphic classification.** The systematic organization of the Earth's rock bodies, as they are found in their original relationships, into units based on any of the properties or attributes that may be useful in stratigraphic work.

4. **Stratigraphic unit.** A body of rock established as a distinct entity in the classification of the Earth's rocks, based on any of the properties or attributes or combinations thereof that rocks possess. Stratigraphic units based on one property will not necessarily coincide with those based on another.

5. **Stratigraphic terminology.** The total of unit-terms used in stratigraphic classification. It may be either formal or informal.

a. **Formal** stratigraphic terminology uses unit-terms that are defined and named according to guidelines conventionally established.

b. **Informal** stratigraphic terminology uses unit-terms as ordinary nouns in a descriptive sense, not as a part of a specific scheme of stratigraphic classification. The use of informal terms in published documents is *strongly discouraged*.

6. **Stratigraphic nomenclature.** The system of proper names given to specific stratigraphic units.

7. **Zone.** A minor body of rock in many different categories of stratigraphic classification. The type of zone indicated is made clear by a prefix, e.g., lithozone, biozone, chronozone.

8. **Horizon.** An interface indicative of a particular position in a stratigraphic sequence. The type of horizon is indicated by a prefix, e.g., lithohorizon, biohorizon, chronohorizon.

9. **Correlation.** A demonstration of correspondence in character and/or stratigraphic position. The type of correlation is indicated by a prefix, e.g., lithocorrelation, biocorrelation, chronocorrelation.

10. **Geochronology.** The science of dating and determining the time sequence of the events in the history of the Earth.

11. **Geochronologic unit.** A subdivision of geologic time.

12. **Geochronometry.** A branch of geochronology that deals with the quantitative (numerical) measurement of geologic time. The abbreviations **ka** for thousand (10^3), **Ma** for million (10^6), and **Ga** for billion (milliard of thousand million, 10^9) years are used.

13. **Facies.** The term "facies" originally meant the lateral change in lithologic aspect of a stratigraphic unit. Its meaning has been broadened to express a wide range of geologic concepts: environment of deposition, lithologic composition, geographic, climatic or tectonic association, etc.

14. **Caution against preempting general terms for special meanings.** The preempting of general terms for special restricted

In the preparation of this short version of the *Guide* it was considered necessary to define the way certain terms, listed below, are used. There has been a tendency to use the terms define, describe, characterize, diagnose, and identify as virtual synonyms in much of our literature. These words have different preferred meanings and an attempt is made here to use each of them in one way so that the meaning is always clear.

to characterize is to state what is unique, thus, a characterization of a stratigraphic unit specifies its unique attributes or unique combination of attributes.

to classify is to arrange the data in a study into a set of categories that have defined boundaries or unit characterizations.

to define is to set limits. A definition, thus, sets limits or boundaries to units in the classification.

to describe is to summarize the total content and relationships of the unit of the classification. Thus, a description is a summary of all the attributes of the unit.

to diagnose is to state which character or combination of characters permits unambiguous identification of a unit in a classification.

to identify is to recognize a set of observations as falling within the defined boundaries or bearing the unique attributes of a category of a classification.

meanings has been a source of much confusion. The preferable procedure is to conserve the original general meaning of a term and to seek a more precise and less ambiguous word for the special meaning.

B. Procedures for Establishing and Revising Stratigraphic Units.

The proposal of a new formal stratigraphic unit requires a statement of intent to introduce the new unit and the reasons for the action. A new unit must be *duly proposed and duly described*. This includes:

- A clear and complete definition, characterization, and description of the unit so that any subsequent investigator can identify it.
- The proposal of the kind, name, and rank of the unit.
- The designation of a stratotype (type section) or type locality on which the unit is based and which may be used by interested scientists as a reference.
- Publication in a recognized scientific medium.

1. Definition, characterization, and description.

a. **Name** (see section 3.B.5).

b. **Stratotypes or other standards of reference.** Gives the geographic location and geologic setting of the stratotype with an indication of accessibility, maps, and markers, both artificial and natural.

For units of the type for which it is impractical to use stratotypes as standards, reliance is placed on the accurate description and illustration of those features that constitute the diagnostic criteria of the unit.

c. **Description of unit at stratotype or type locality.**

d. **Regional aspects.** Geographic extent; regional variations in thickness, lithostratigraphy, biostratigraphy or other properties; nature of boundaries away from the type; criteria to be used in identifying and extending the unit over the area of its presence.

e. **Geologic age.**

f. **Correlation with other units.**

g. **Genesis (where appropriate).**

h. **References to the literature.**

2. Special requirements for establishing subsurface units.

The same rules of procedure used for outcrop sections apply to subsurface units established on the basis of exposures in mines, tunnels or from sections penetrated in wells. Stratotypes in well sections are designated by well depths and on well logs and in cores, if available. The following data are desirable for establishing subsurface units:

a. **Designation of well or mine.** The name of the well or mine and geographic location using conventional oil field or topographic nomenclature.

b. **Geologic logs.** Lithologic and paleontologic logs of the well or wells, and maps and cross sections of the mine, in written and graphic form with the boundaries of the new unit and its subdivisions.

c. **Geophysical Logs and Profiles.** Electrical and/or other wire-line logs and seismic profiles with boundaries and subdivisions of the unit shown at a scale adequate to permit appreciation of detail.

d. **Depositories.** A depository should be an institution with the proper curatorial facilities and assurance of perpetuity where the materials are available for study. The location of the depository for materials from the stratotype well, tunnel or mine should be given.

3. Naming of stratigraphic units.

The names of most formal stratigraphic units consist of an appropriate geographic name combined with an appropriate term indicating the kind and rank of the unit, e.g. La Luna Formation, except for some terms that were established in the early history of stratigraphy.

The formal name of a biostratigraphic unit is formed from the names of one or more appropriate fossils combined with the appropriate term for the kind of biostratigraphic unit, e.g., *Exus albus* Assemblage Zone. (see Chapter 7).

a. Geographic component of names of stratigraphic units

i. *Source.* Geographic names should be derived from permanent natural or artificial features at or near which the stratigraphic unit is present. A name should be on standard published maps of the pertinent political jurisdiction. Where such names are not available, the place from which the name is derived should be described and shown on an appropriately scaled map accompanying the description of the new unit. Short names are preferable to long or compound names. The name of the stratigraphic unit should be exactly the same as the name of the geographic feature after which it is named.

ii. *Spelling of Geographic Names.* The spelling of the geographic component of the name of a stratigraphic unit should conform to the usage of the country of origin. The spelling of the geographic component, once established, should not be changed. The rank or lithologic component may be changed when translated to a different language.

iii. *Changes in Geographic Names.* The change in the name of a geographic feature does not affect the name of the associated stratigraphic unit nor does disappearance of the geographic feature require a new name.

iv. *Inappropriate Geographic Names.* A geographic name should not be misleading, e.g. London Formation for a unit in Canada, although a city with that name exists in Canada.

v. *Duplication of Geographic Names.* The name of a new stratigraphic unit should be unique in order to prevent ambiguity. The IUGS *Lexique Stratigraphique Internationale* and national and regional lexicons contain lists of previously used names and inquiry to geological surveys and other regional organizations is recommended to discover previously used names not yet published in the lexicons.

vi. *Names for subdivisions of Stratigraphic Units.* If a unit is divided into two or more formal component units, the geographic name of the original unit should not be employed for any of the subdivisions.

b. **Unit-term Component of Names of Stratigraphic Units.** The unit-term component of a stratigraphic name indicates the kind and rank of the unit. A stratigraphic unit-term may differ in different languages.

c. **Relation of Names to Political Boundaries.** Stratigraphic units are not limited by international boundaries and should not differ across them.

d. **Reduction in number of names through correlation.** If correlation has established the identity of two differently named stratigraphic units, the later name should be replaced by the earlier, other considerations being equal.

e. **Uncertainty in Assignment.** If identification of a stratigraphic unit is in doubt, that uncertainty should be expressed in the nomenclature employed. The following conventions may be used:

Devonian?	= doubtfully Devonian
Macao? Formation	= doubtfully Macoa Formation
Peroc-Macoc formation	= strata intermediate in position (horizontally or vertically) between two stratigraphic units
Silurian-Devonian	= one part Silurian, one part Devonian
Silurian or Devonian	= either Silurian or Devonian
Silurian and Devonian	= both Silurian and Devonian, but undifferentiated.

The name of the older or lower unit, if this distinction can be made, should always come first when two units are hyphenated or used in combination.

f. **Abandoned Names.** The name of a stratigraphic unit, once applied and then abandoned, should not be revived except in its original sense. Reference to abandoned names should indicate the original sense in which the name was used, e.g. "Mornas Sandstone of Hebert (1874)".

g. **Preservation of Traditional of Well-Established Names.** Traditional or well-established names that do not follow the above

procedures and conventions should not be abandoned providing they are or may become well defined or characterized.

4. Publication

a. **A Recognized Scientific Medium.** Establishment or revision of a formal stratigraphic unit requires publication in a *recognized scientific medium*. The main qualifications of a recognized scientific medium are that it is regularly published and reasonably available to the scientific public on request by purchase or through a library. Abstracts, most fieldtrip guidebooks, dissertations, company reports, open file reports and similar media generally do not meet this requirement.

b. **Priority.** Publication of a properly proposed, named, and described unit has priority. However, priority alone does not justify displacing a well-established name by one not well known or rarely used; nor should an inadequately established name be preserved merely because of priority.

c. **Recommended Editorial Procedures.** The editorial rules and procedures enumerated below apply to the English language. Rules of orthography of other languages may make these recommendations inapplicable.

i. *Capitalization.* The first letters of all words used in the names of formal stratigraphic units are capitalized (except for the trivial names of species and subspecies rank in the names of biostratigraphic units). Informal terms are not capitalized.

ii. *Hyphenation.* Compound terms for most kinds of stratigraphic units, in which two common words are joined to give a special meaning, should be hyphenated, e.g. concurrent-range zone, normal-polarity zone. Exceptions are adjectival prefixes or combining forms that are generally combined with the term-noun without a hyphen, e.g. biozone.

iii. *Repetition of the Complete Name.* After the complete name of a stratigraphic unit has been referred to once in a publication, part of the name may be omitted for brevity if the meaning is clear, e.g., the Oxfordian Stage may be referred to as "the Oxfordian", or "the Stage".

5. Revision or redefinition of previously established stratigraphic units

Revision or redefinition of an adequately established unit without changing its name requires a statement of intent to revise the unit, the reasons for doing so, and as much justification and documentation as for proposing a new unit. Change in rank of a stratigraphic unit does not require redefinition of the unit or its boundaries, or alteration of the geographic part of the name. A stratigraphic unit may be promoted or demoted in rank without changing the geographic part of its name.

CHAPTER 4 Stratotypes and Type Localities

A. Stratotypes in the Definition and Characterization of Stratigraphic Units

1. **Standard definitions.** Named stratigraphic units must be defined or characterized at a specified locality where they are well exposed and developed in order that there will be a common, material standard of reference for their identification.

2. **Reference to a specific rock section.** The particular sequence of strata chosen as a standard of reference of a layered stratigraphic unit is called a stratotype. In the case of nonlayered rocks the standard of reference is a type locality. It may be an area of exposure (or well or mine) and is an essential part of the establishment of a formal stratigraphic unit. In cases where the written description and the stratotype are not the same, the data from the stratotype take precedence.

For some stratigraphic units, such as biostratigraphic range zones, the standard of the unit cannot be tied to a specific stratigraphic section or area because the stratigraphic scope of the unit may vary with increasing information. However, the characterization and description of these and other biostratigraphic units can be enhanced by the designation of one or more specific reference sections.

B. Definitions

1. **Stratotype (type section).** The designated exposure of a named layered stratigraphic unit or of a stratigraphic boundary that serves as the standard of reference. A stratotype is the specific stratal sequence used for the definition and/or characterization of the stratigraphic unit or boundary being defined.

2. **Unit-stratotype.** The type section of a layered stratigraphic unit that serves as the standard of reference for the definition and characterization of the unit.

3. **Boundary-Stratotype.** The specified sequence of strata that contains the specific point that defines a boundary between two stratigraphic units.

4. **Composite-Stratotype.** A unit-stratotype formed by the combination of several specified intervals of strata combined to make a composite standard of reference.

5. **Type Locality.** The specific geographic locality where the stratotype of a layered stratigraphic unit is situated. The name also refers to the locality where the unit was originally described and/or named. In the case of units composed of nonlayered igneous or metamorphic rocks, the type locality is the specific geographic locality where the unit was originally defined.

6. **Type Area or Type Region.** The geographic area or region that encompasses the stratotype or type locality of a stratigraphic unit or boundary.

7. **Holo-, para-, neo-, lecto-, and hypostratotypes.**

C. Requirements for Stratotypes (Type Sections)

The following requirements apply to stratotypes:

1. **Expression of concept.** The most important requisite of a stratotype is that it adequately represents the concept for which it is the material type.

2. **Description.** The description of a stratotype is both geographic and geologic. The geographic description includes a detailed location map and/or aerial photographs and indication of the means of access to the type locality and the distribution of the unit in the area.

The geologic description covers the geologic, paleontologic, geophysical, and geomorphic features of the unit at the type section. The description contains two parts: a part that deals with the boundaries and a part that deals with the content of the unit.

3. **Identification and marking.** An important requirement of a stratotype is that it should be clearly marked. A boundary-stratotype is marked at a point, preferably by a permanent monument. Unit boundaries should be clearly designated by reference to permanent geologic and geographic features at the type locality.

4. **Accessibility and assurance of preservation.** Stratotypes must be accessible to all who are interested in their study, regardless of political or other circumstances, and there should be reasonable assurance of their long-term preservation.

5. **Subsurface stratotypes.** Subsurface stratotypes are acceptable if adequate surface sections are lacking and if adequate subsurface samples and logs are available.

6. **Acceptability.** The usefulness of the stratotypes for stratigraphic units of international extent is directly related to the extent to which they are generally accepted or acknowledged as the standard of reference for the units. It is, therefore, desirable that the designation of a stratotype be submitted for approval to the geologic body having the highest standing in any particular case. The IUGS International Commission on Stratigraphy is the body to which proposals for the designation of stratotypes of units of worldwide application are submitted. Stratotypes of local units require the approval from local or national surveys or stratigraphic commissions.

D. Requirements for Type Localities of Nonlayered Igneous or Metamorphic Rock Bodies

Type localities and type areas for nonlayered igneous or metamorphic rock bodies should represent the material concept of the unit and have other attributes of description, definition, location, and accessibility that apply to layered stratigraphic units.

CHAPTER 5 Lithostratigraphic Units

A. Nature of Lithostratigraphic Units

Lithostratigraphic units are bodies of rocks, bedded or unbedded, that are defined and characterized on the basis of their lithologic properties and their stratigraphic relations. Lithostratigraphic units are the basic units of geologic mapping.

The relationship of lithostratigraphic units to other kinds of stratigraphic units is discussed in Chapter 10.

B. Definitions

1. **Lithostratigraphy.** The element of stratigraphy that deals with the description and nomenclature of the rocks of the Earth based on their lithology and their stratigraphic relations.

2. **Lithostratigraphic classification.** The organization of rock bodies into units on the basis of their lithologic properties and their stratigraphic relations.

3. **Lithostratigraphic unit.** A body of rocks that is defined and recognized on the basis of its lithologic properties or combination of lithologic properties and stratigraphic relations. A lithostratigraphic unit may consist of sedimentary, or igneous, or metamorphic rocks. Lithostratigraphic units are defined and recognized by observable physical features and not by their inferred age, the time span they represent, inferred geologic history, or manner of formation. The geographic extent of a lithostratigraphic unit is controlled entirely by the continuity and extent of its diagnostic lithologic features.

C. Kinds of lithostratigraphic Units

1. **Formal lithostratigraphic units.** See Table 1 and section 3.A.5. The conventional hierarchy of formal lithostratigraphic terms is as follows:

Group—two or more formations

Formation—primary unit of lithostratigraphy

Member—named lithologic subdivision of a formation

Bed—named distinctive layer in a member or formation

Flow—smallest distinctive layer in a volcanic sequence

The component units of any higher rank unit in the hierarchy need not be everywhere the same.

2. **Formation.** The primary formal unit of lithostratigraphic classification. Formations are the only formal lithostratigraphic units into which the stratigraphic column everywhere should be divided completely on the basis of lithology.

The contrast in lithology between formations required to justify their establishment varies with the complexity of the geology of a region and the detail needed for geologic mapping and to work out its geologic history. No formation is considered justifiable and useful that cannot be delineated at the scale of geologic mapping practiced in the region. The thickness of formations may range from less than a meter to several thousand meters.

3. **Member.** The formal lithostratigraphic unit next in rank below a formation. It possesses lithologic properties distinguishing it from adjacent parts of the formation. No fixed standard is required for the extent and thickness of a member.

A formation need not be divided into members unless a useful purpose is thus served. Some formations may be completely divided

into members; others may have only certain parts designated as members. A member may extend from one formation to another.

Specially shaped forms of members (or of formations) are lenses and tongues. A *lens* is a lens-shaped body of rock of different lithology than the unit that encloses it. A *tongue* is a projecting part of a lithostratigraphic unit extending out beyond its main body.

4. **Bed.** The smallest formal unit in the hierarchy of sedimentary lithostratigraphic units, e.g. a single stratum lithologically distinguishable from other layers above and below. Customarily only distinctive beds (*key beds*, *marker beds*) particularly useful for stratigraphic purposes are given proper names and considered formal lithostratigraphic units.

5. **Flow.** A discrete extrusive volcanic body distinguishable by texture, composition, or other objective criteria. The designation and naming of flows as formal lithostratigraphic units should be limited to those that are distinctive and widespread.

6. **Group.** A succession of two or more contiguous or associated formations with significant and diagnostic lithologic properties in common. Formations need not be aggregated into groups unless doing so provides a useful means of simplifying stratigraphic classification in certain regions or certain intervals. Thickness of a stratigraphic succession is not a valid reason for defining a unit as a group rather than a formation. The component formations of a group need not be everywhere the same.

7. **Supergroup and subgroup.** The term “supergroup” may be used for several associated groups or for associated groups and formations with significant lithologic properties in common. Exceptionally, a group may be divided into subgroups.

8. **Complex.** A lithostratigraphic unit composed of diverse types of any class or classes or rocks (sedimentary, igneous, metamorphic) and characterized by irregularly mixed lithology or by highly complicated structural relations.

9. **Lithostratigraphic horizon (Lithohorizon).** A surface of lithostratigraphic change, commonly the boundary of a lithostratigraphic unit, or a lithologically distinctive very thin marker bed within a lithostratigraphic unit.

10. **Informal lithostratigraphic units.** Lithostratigraphic units recognized in preliminary studies and not fully described and characterized are sometimes given names. Such names should be considered informal and should not be included in published documents. If a unit merits a formal name it merits proper formal definition and description.

D. Procedures for Establishing Lithostratigraphic Units

1. **Stratotypes and type localities as standard of definition.** Each formal lithostratigraphic unit should have a clear and precise definition or characterization. The designation of a stratotype for a layered unit or a type locality for a nonlayered unit is essential. Designation of auxiliary reference sections or additional type localities may be used to supplement the definition of a lithostratigraphic unit. Where a complete section of a unit does not crop out in an area, the lower and upper boundary-stratotypes at specific sections are designated.

2. **Boundaries.** Boundaries of lithostratigraphic units are placed at positions of lithologic change or arbitrarily within zones of vertical or lateral lithologic gradation or intertonguing. In subsurface work, because of caving in drill holes, it is best to define lithostratigraphic boundaries at the highest occurrence of a particular rock type rather than at the lowest.

Boundaries of lithostratigraphic units commonly cut across time surfaces, across the limits of fossil ranges, and across the boundaries of any other kind of stratigraphic units.

3. **Unconformities and hiatuses.** Stratigraphic sequences of similar lithologic composition but separated by regional unconformities or major hiatuses should be mapped as separate lithostratigraphic units. Local or minor hiatuses, disconformities or unconformities within a sequence of similar lithologic composition should

not be considered reason for recognition of more than one lithostratigraphic unit.

E. Procedures for Extending Lithostratigraphic Units—Lithostratigraphic Correlation

A lithostratigraphic unit and its boundaries are extended away from the type section or type locality only as far as the diagnostic lithologic properties on which the unit is based may be identified.

1. **Use of indirect evidence for identification of units and their boundaries.** Where lithologic identity is difficult to determine because of poor or no outcrops, a lithostratigraphic unit and its boundaries may be identified and correlated on the basis of indirect evidence: geomorphic expression, wire-line logs, seismic reflections, distinctive vegetation, etc.

2. **Marker beds used as boundaries.** The top or the base of a marker bed may be used as a boundary for a formal lithostratigraphic unit where the marker bed occurs at or near a recognizable vertical change in lithology.

F. Naming of Lithostratigraphic Units

1. **General.** The name of lithostratigraphic units follows the general rules for naming stratigraphic units (section 3.B.3). In the case of lithostratigraphic units, a simple lithologic term indicating its dominant rock type may be used instead of the unit-term indicating its rank (group, formation, member, bed). However, the use of the unit-term is preferable; and the use of both the lithologic term and the unit-term *should be discouraged*. The terms “lower”, “middle”, and “upper” should not be used for formal subdivisions of lithostratigraphic units.

2. **Geographic component of name.** See section 3.B.3.a.

In the case of lateral changes in lithologic composition, change in the geographic term is desirable for important regional changes, but the indiscriminate proposal of new names for minor lithologic variations is undesirable.

3. **Lithologic component of name.** If a lithologic term is used in the name of a lithostratigraphic unit it should be a simple, generally accepted term that indicates the predominant lithology of the unit. Compound, combined or lithogenetic terms should not be used.

4. **Some special aspects of igneous and metamorphic rocks.** Stratified volcanic rocks and bodies of metamorphic rocks that can be recognized as of sedimentary and/or extrusive volcanic origin can be treated as sedimentary lithostratigraphic units.

Nonlayered intrusive rocks and bodies of metamorphic rocks that are deformed and/or recrystallized so that their original layering and stratigraphic succession can no longer be ascertained require a somewhat different treatment. As lithostratigraphic units, their name should be composed of an appropriate local geographic term combined with either a unit-term or a simple field lithologic term. However, since most geologists may agree that unit-terms such as “group”, “formation”, or “member” imply stratification and position within a stratified sequence, it is more appropriate to use simple field lithologic terms such as “granite”, “gneiss”, or “schist” for these nonlayered units. Also appropriate is the use of the terms “complex”, “melange”, and “ophiolite”. On the other hand, the use of the term “suite” seems inadvisable. The term has been commonly used for associations of comagmatic intrusive igneous rock bodies of similar or related lithologies and close association in time, space, and origin.

The use of adjectival qualifiers such as “plutonic”, “igneous”, or “volcanic”, though preferably minimized in the formal nomenclature of lithostratigraphic units, may be used when they help to clarify the nature of a unit, as for instance a complex, e.g., “igneous complex”, “volcanic complex”.

Adjectives used as nouns, such as “volcanics” or “metamorphics”, preferably should be avoided even though they have been used widely.

The lithostratigraphic names of igneous and metamorphic rock bodies should not include terms that express form or structure such as “dike”, “sill”, “pluton”, and “neck”, or the more general term “intrusion”. These terms do not indicate lithology, are not unit-terms in the lithostratigraphic hierarchy, and are not, therefore, lithostratigraphic terms.

G. Revision of Lithostratigraphic Units

See sections 3.B.5, 5.F.2, and 5.F.3.

CHAPTER 6 Unconformity-bounded Units

A. Nature of Unconformity-bounded Units

Unconformity-bounded units are bodies of rocks bounded above and below by significant unconformities. They are composed of diverse types of any kind or kinds of rocks, but the lithologic properties of these rocks, their fossil content, or the chronostratigraphic span of the rocks on either side of the bounding unconformities are significant only to the extent that they serve to recognize the bounding unconformities.

Unconformity-bounded units are objective stratigraphic units established and identified without regard for the genetic or causal interpretation of their bounding unconformities.

The relation of unconformity-bounded units to other kinds of stratigraphic units is discussed in Chapter 10.

B. Definitions

1. **Unconformity-bounded unit.** A body of rocks bounded above and below by specifically designated, significant discontinuities in the stratigraphic succession preferably of regional or interregional extent. The diagnostic criteria used to establish and to identify an unconformity-bounded unit are its two designated bounding unconformities. Unconformity-bounded units may include any number of other kinds of stratigraphic units.

2. **Unconformity.** A surface of erosion between rock bodies that represents a significant hiatus or gap in the stratigraphic succession. Some kinds of unconformities are:

a. **Angular unconformity.** An unconformity in which the bedding planes above and below the unconformity are at an angle to each other.

b. **Disconformity.** An unconformity in which the bedding planes above and below the stratigraphic break are essentially parallel.

c. **Diastem.** A short interruption in deposition with little or no erosion before resumption of sedimentation. Diastems are not an appropriate basis for establishing unconformity-bounded units.

C. Kinds of Unconformity-bounded Units

The basic unconformity-bounded unit is the *synthem*.

The term “*synthem*” as used to designate unconformity-bounded units has received very limited acceptance and use since first proposed by Chang in 1975, and subsequently discussed in several ISSC publications. It may be preferable, therefore, to discard “*synthem*” and employ the widely used term “*sequence*” not only as the basic unit of sequence stratigraphy, but also to designate all stratigraphic units totally or partly bounded by unconformities.

D. Hierarchy of Unconformity-bounded Units

E. Procedures for establishing unconformity-bounded units

See section 3.B. Because the presence or absence of the bounding discontinuities is the single diagnostic criterion for establishing, defining, recognizing, and extending unconformity-bounded units, the definition of these units should emphasize the discussion of the nature, position, and characteristics of the discontinuities.

Unconformity-bounded units should be established only where and when they can fulfill a need that other kinds of stratigraphic units cannot meet.

F. Procedures for Extending Unconformity-bounded Units

An unconformity-bounded unit should be extended laterally only as far as *both* of its bounding unconformities are identifiable.

G. Naming of Unconformity-bounded Units

See section 3.B.3.

H. Revision of Unconformity-bounded Units

See section 3.B.5.

CHAPTER 7 Biostratigraphic Units

A. Nature of Biostratigraphic Units

Biostratigraphic units (biozones) are bodies of strata that are defined or characterized on the basis of their contained fossils.

Biostratigraphic units exist only where the particular diagnostic feature or attribute on which they are based has been identified. Biostratigraphic units, therefore, are objective units based on the identification of fossil taxa. Their recognition depends on the identification of either their defining or characterizing attributes. Biostratigraphic units may be enlarged to include more of the stratigraphic record, both vertically and geographically, when additional data are obtained. In addition, since they depend on taxonomic practice, changes in their taxonomic base may enlarge or reduce the body of strata included in a particular biostratigraphic unit.

A biostratigraphic unit may be based on a single taxon, on combinations of taxa, on relative abundances, on specified morphological features, or on variations in any of the many other features related to the content and distribution of fossils in strata. The same interval of strata may be zoned differently depending on the diagnostic criteria or fossil group chosen. Thus, there may be several kinds of biostratigraphic units in the same interval of strata that may have gaps between them or overlaps of their vertical and horizontal ranges.

Biostratigraphic units are distinct from other kinds of stratigraphic units in that the organisms whose fossil remains establish them show evolutionary changes through geologic time that are not repeated in the stratigraphic record. This makes the fossil assemblages of any one age distinctive from any other.

The relationship of biostratigraphic units to other kinds of stratigraphic units is discussed in Chapter 10.

B. The Fossils

1. **Value of fossils.** Fossils were once living organisms and as such are sensitive indicators of past environments, sedimentation patterns, and their distributions. In addition, because of the irreversibility of evolution, fossils are particularly useful in working out the relative times of origin of sedimentary strata.

2. **Fossil assemblages.** Four kinds of intervals are found in sedimentary rocks: strata without fossils; strata containing organisms that lived and were buried in the area (biocoenosis); strata containing

organisms that lived somewhere else and were brought into the area after death (thanatocoenosis); and strata that contain organisms transported alive away from their normal environment. These may be mixed or interbedded in any proportion. All categories of fossil-bearing strata may be the basis for biostratigraphic zonation. Intervals lacking identifiable fossils or entirely without fossils are not subject to biostratigraphic classification.

3. **Reworked fossils.** Fossils from rocks of one age that have been eroded, transported, and redeposited in sediments of a younger age. Because of the difference in their significance with respect to age and environment, they should be treated apart from those believed to be indigenous.

4. **Introduced or infiltrated fossils.** Fossils introduced into older or younger rocks by fluids, through animal burrows or root cavities, or by sedimentary dikes or diapirs. They should be distinguished from indigenous fossils in biostratigraphic zonation.

5. **Effects of stratigraphic condensation.** Extremely low rates of sedimentation may result in fossils of different ages and different environments being mingled or very intimately associated in a very thin stratigraphic interval, even in a single bed.

C. Definitions

1. **Biostratigraphy.** The element of stratigraphy that deals with the distribution of fossils in the stratigraphic record and the organization of strata into units on the basis of their contained fossils.

2. **Biostratigraphic classification.** The systematic subdivision and organization of the stratigraphic section into named units based on their fossil content.

3. **Biostratigraphic zone (Biozone).** A general term for any kind of biostratigraphic unit regardless of thickness or geographic extent. See section 3.A.7. After initial usage of a formal term, such as the *Globigerina brevis* Taxon-range Biozone, a simplified version of the formal nomenclature may be used, e.g. *Globerigina brevis* Zone. Biozones vary greatly in thickness, geographic extent, and represented time span.

4. **Biostratigraphic horizon (Biohorizon).** A stratigraphic boundary, surface, or interface across which there is a significant change in biostratigraphic character. A biohorizon has no thickness and should not be used to describe very thin stratigraphic units that are especially distinctive.

5. **Subbiozone (Subzone).** A subdivision of a biozone.

6. **Superbiozone (Superzone).** A grouping of two or more biozones with related biostratigraphic attributes.

7. **Zonule.** The use of this term is discouraged. It has received different meanings and is now generally used as a subdivision of a biozone or subbiozone.

8. **Barren intervals.** Stratigraphic intervals with no fossils common in the stratigraphic section.

D. Kinds of Biostratigraphic Units

1. **General.** Five kinds of biozones are in common use: range zones, interval zones, assemblage zones, abundance zones, and lineage zones. These types of biozones have no hierarchical significance, and are not based on mutually exclusive criteria. A single stratigraphic interval may, therefore, be divided independently into range zones, interval zones, etc., depending on the biostratigraphic features chosen.

2. **Range Zone.** The body of strata representing the *known stratigraphic and geographic range* of occurrence of a particular taxon or combination of two taxa of any rank.

There are two principal types of range zones: taxon-range zones and concurrent-range zones.

a. **Taxon-range Zone (see Figure 1).**

i. **Definition.** The body of strata representing the known range of stratigraphic and geographic occurrence of specimens of a particular taxon. It is the sum of the documented occurrences in all individual sections and localities from which the particular taxon has been identified.

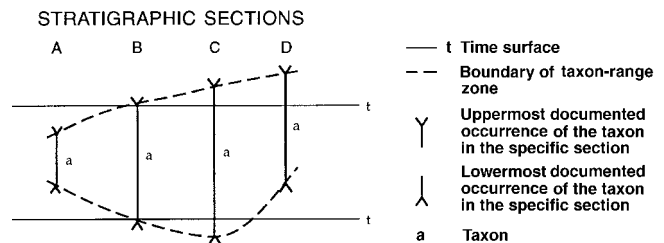

Figure 1 Taxon-range Zone. The lower, upper, and lateral limits of this zone are determined by the range of occurrence of taxon *a*.

ii. **Boundaries.** The boundaries of a taxon-range zone are biohorizons marking the outermost limits of known occurrence in every local section of specimens whose range is to be represented by the zone. The boundaries of a taxon-range zone in any one section are the horizons of lowest stratigraphic occurrence and highest stratigraphic occurrence of the specified taxon in that section.

iii. **Name.** The taxon-range zone is named from the taxon whose range it expresses.

iv. **Local Range of a Taxon.** The local range of a taxon may be specified in some local section, area, or region as long as the context is clear.

b. **Concurrent-range Zone (see Figure 2)**

i. **Definition.** The body of strata including the overlapping parts of the range zones of two specified taxa. This type of zone may include taxa additional to those specified as characterizing elements of the zone, but only the two specified taxa are used to define the boundaries of the zone.

ii. **Boundaries.** The boundaries of a concurrent-range zone are defined in any particular stratigraphic section by the lowest stratigraphic occurrence of the higher-ranging of the two defining taxa and the highest stratigraphic occurrence of the lower-ranging of the two defining taxa.

iii. **Name.** A concurrent-range zone is named from both the taxa that define and characterize the biozone by their concurrence.

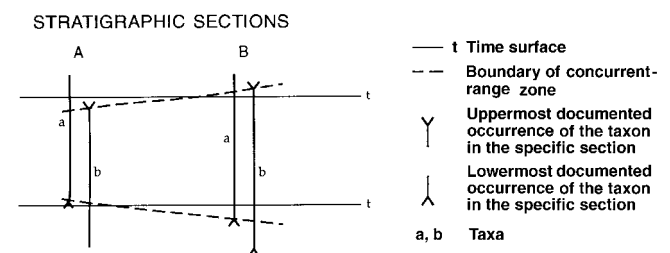

Figure 2 Concurrent-range Zone. The lower, upper, and lateral limits of this zone are determined by the range of concurrent occurrence of taxa *a* and *b*.

3. **Interval Zone (see Figures 3 and 4).**

a. **Definition.** The body of fossiliferous strata between two specified biohorizons. Such a zone is not itself necessarily the range zone of a taxon or concurrence of taxa; it is defined and identified only on the basis of its bounding biohorizons (Figure 3).

In subsurface stratigraphic work, where the section is penetrated from top to bottom and paleontological identification is generally made from drill cuttings, often contaminated by recirculation of previously drilled sediments and material sloughed from the walls of the drill hole, interval zones defined as the stratigraphic section comprised between the highest known occurrence (first occurrence downward) of two specified taxa are particularly useful (Figure 4). This type of interval zone has been called "last-occurrence zone" but should preferably be called "highest-occurrence zone".

Interval zones defined as the stratigraphic section comprised between the lowest occurrence of two specified taxa ("lowest-occurrence zone") are also useful, preferably in surface work.

b. **Boundaries.** The boundaries of an interval zone are defined by the occurrence of the biohorizons selected for its definition.

c. **Name.** The names given to interval zones may be derived from the names of the boundary horizons, the name of the basal boundary preceding that of the upper boundary; e.g. *Globigerinoides sicanus-Orbulina suturalis* Interval Zone. In the definition of an interval zone, it is desirable to specify the criteria for the selection of the bounding biohorizons, e.g. lowest occurrence, highest occurrence etc. An alternative method of naming uses a single taxon name for the name of the zone. The taxon should be a usual component of the zone, although not necessarily confined to it.

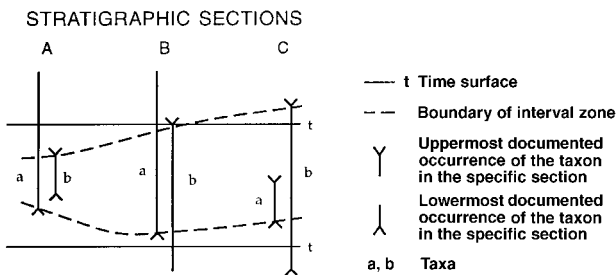

Figure 3 Interval Zone. In this example, the lower limit of the zone is the lowermost known occurrence of taxon a, and the upper limit is the highest known occurrence of taxon b. The zone extends laterally as far as both of the defining biohorizons can be recognized.

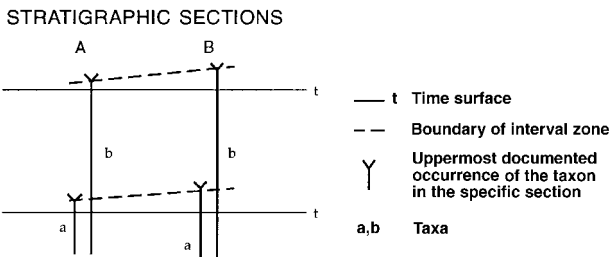

Figure 4 Interval Zone (Highest-occurrence Zone). This kind of interval zone is particularly useful in subsurface work.

4. Lineage Zone (see Figure 5).

Lineage zones are discussed as a separate category because they require for their definition and recognition not only the identification of specific taxa but the assurance that the taxa chosen for their definition represent successive segments of an evolutionary lineage.

a. **Definition.** The body of strata containing specimens representing a specific segment of an evolutionary lineage. It may represent the entire range of a taxon within a lineage (Figure 5A) or only that part of the range of the taxon below the appearance of a descendant taxon (Figure 5B).

The boundaries of lineage zones approach the boundaries of chronostratigraphic units. However, a lineage zone differs from a chronostratigraphic unit in being restricted, as all biostratigraphic units are, to the actual spatial distribution of the fossils.

Lineage zones are the most reliable means of correlation of relative time by use of the biostratigraphic method.

b. **Boundaries.** The boundaries of a lineage zone are determined by the biohorizons representing the lowest occurrence of successive elements of the evolutionary lineage under consideration.

c. **Name.** A lineage zone is named for the taxon in the lineage whose range or partial range it represents.

STRATIGRAPHIC SECTIONS

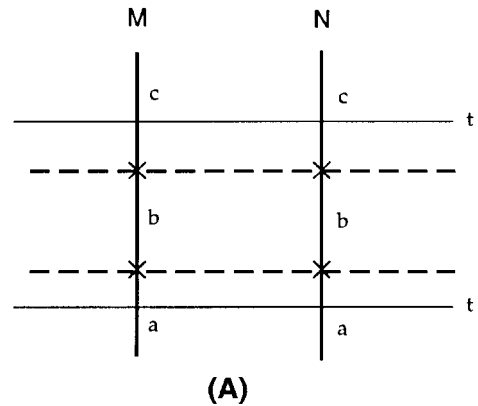

STRATIGRAPHIC SECTIONS

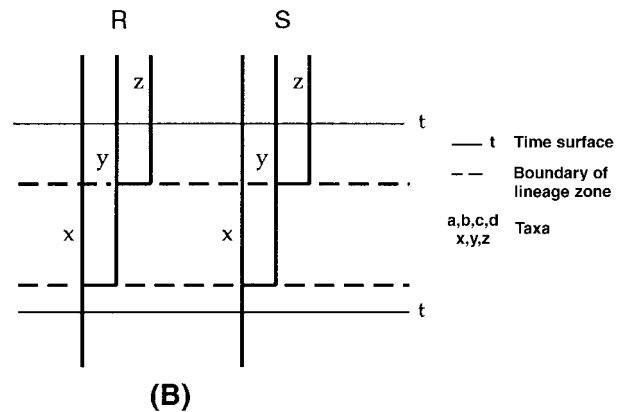

Figure 5 Examples of lineage zones. In A the lineage zone represents the entire range of taxon b, from the highest occurrence of its ancestor, taxon a, to the lowest occurrence of its descendant, taxon c. In B the lineage zone represents that part of the range of taxon y between its lowest occurrence and the lowest occurrence of its descendant, taxon z.

5. Assemblage Zone (see Figure 6).

a. **Definition.** The body of strata characterized by an assemblage of three or more fossil taxa that, taken together, distinguishes it in biostratigraphic character from adjacent strata.

b. **Boundaries.** The boundaries of an assemblage zone are drawn at biohorizons marking the limits of occurrence of the specified assemblage that is characteristic of the unit. Not all members of the assemblage need to occur in order for a section to be assigned to an assemblage zone, and the total range of any of its constituents may extend beyond the boundaries of the zone.

c. **Name.** The name of an assemblage zone is derived from the name of one of the prominent and diagnostic constituents of the fossil assemblage.

6. Abundance Zone (see Figure 7).

a. **Definition.** The body of strata in which the abundance of a particular taxon or specified group of taxa is significantly greater than is usual in the adjacent parts of the section.

Unusual abundance of a taxon or taxa in the stratigraphic record may result from a number of processes that are of local extent, but may be repeated in different places at different times. For this reason, the only sure way to identify an abundance zone is to trace it laterally.

b. **Boundaries.** The boundaries of an abundance zone are defined by the biohorizons across which there is notable change in the abundance of the specified taxon or taxa that characterize the zone.

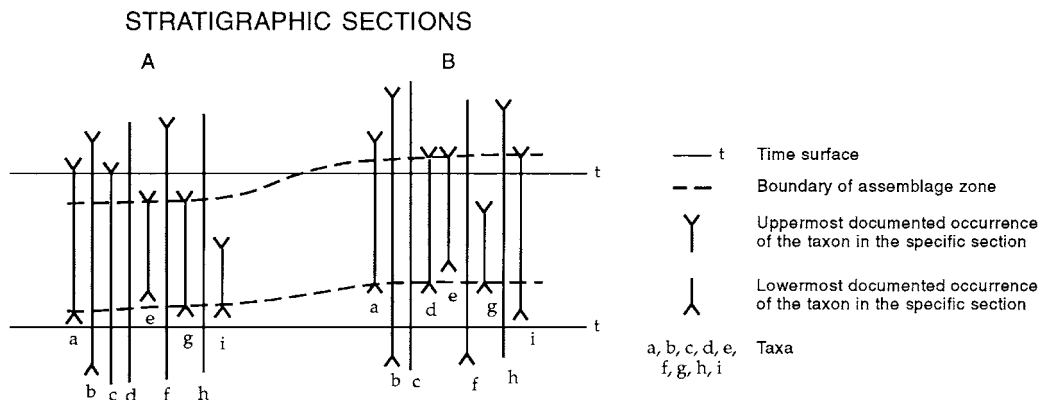

Figure 6 Assemblage zone. In this example, the assemblage diagnostic of the zone includes nine taxa with diverse stratigraphic ranges. For this assemblage zone to be useful, it may be necessary to provide some explicit description of its boundaries: for example, the lower boundary can be said to be placed at the lowermost occurrence of taxa a and g and the upper boundary at the highest occurrence of taxon e. Most of the taxa of the assemblage characteristic of the zone should, however, be present.

c. **Name.** The abundance zone takes its name from the taxon or taxa whose significantly greater abundance it represents.

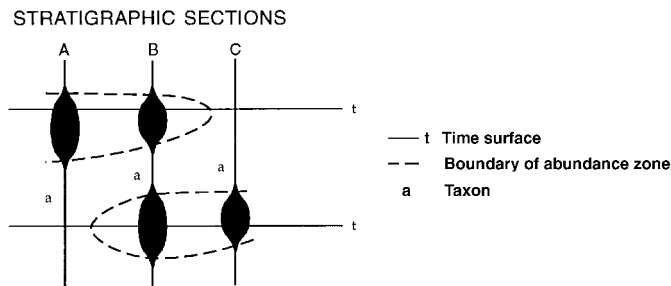

Figure 7 Abundance zones.

E. Hierarchy of Biostratigraphic Units

The different kinds of biostratigraphic units described above do not represent different ranks of a biostratigraphic hierarchy, except in the case of subzones and superzones, where the prefix indicates the position in a hierarchy.

With respect to taxon-range zones, there is no need for a hierarchy of biozone terms because the hierarchical system of biological taxonomy extends also to these biostratigraphic units in the sense that the range zone of a species is subsidiary to the range zone of the genus to which it belongs, and so on.

F. Procedures for Establishing Biostratigraphic Units

See Section 3.B.

It is recommended that the definition or characterization of a biostratigraphic unit include the designation of one or more specific reference sections that demonstrate the stratigraphic context of the taxon or taxa diagnostic of the unit.

G. Procedures for Extending Biostratigraphic Units—Biostratigraphic Correlation

Biostratigraphic units are extended away from the areas where they were defined or from their reference sections by biostratigraphic correlation, which is the establishment of correspondence in biostratigraphic character and position between geographically separated sections or outcrops based on their fossil content. Biostratigraphic correlation is not necessarily time-correlation. It may approximate time correlation, or it may be the identification of the same biofacies, which may be diachronous.

H. Naming Biostratigraphic Units

The formal name of a biostratigraphic unit should be formed from the names of one, or no more than two, appropriate fossils combined with the appropriate term for the kind of unit in question. The function of a name is to provide a unique designation for the biozone. Thus, any taxon in the characteristic assemblage of a biozone may serve as name-bearer so long as it is not already employed.

The printing of fossil names for stratigraphic units should be guided by the rules laid down in the *International Code of Zoological Nomenclature* or the *International Code of Botanical Nomenclature*. The initial letter of the unit-term (Biozone, Zone, Assemblage Zone) should be capitalized as well as that of the generic names; the initial letter of the specific epithets should be in lowercase; taxonomic names of genera and species should be in italics, for example *Exus albus* Range Zone.

The name of the taxon chosen to designate a biozone should include the entire name of the taxon. Thus, *Exus albus* is correct. After the first mention, the name may be abbreviated in any way consistent with clarity.

Codification of biostratigraphic zones by letters or numbers or a combination of both is becoming common practice. If used consistently and judiciously such code designations can be extremely useful. They are brief, generally indicate the sequence and relative positions of the zones, and they facilitate communication between biostratigraphers, geologists, and other professionals. However, they do not lend themselves to insertions, combinations, deletions, or other modifications once the zonation has been published. Also, they may be a source of confusion if more than one zonation of a particular sequence of strata employs the same designations but in different ways. Code designations of biostratigraphic units should be considered informal nomenclature.

I. Revision of Biostratigraphic Units

Revision of biostratigraphic units honors priority for the sake of stability and precision in communication. However, the first biostratigraphic zonation to be described is not necessarily the most useful. Revision or new biozonations should be clearly defined and/or characterized, be more widely applicable, offer greater precision, and be more easily identified.

Changes in nomenclature of biostratigraphic units conform with changes in the names of taxa as required by the *International Codes of Zoological and Botanical Nomenclature*.

Named biostratigraphic units will automatically change scope to accord with changes in the scope of taxa defining or characterizing them. A fossil name once used for a biozone is not available for use in a different zonal sense by a later author. If it is desirable to continue the use of a taxonomic term that is no longer valid, the term should be placed in quotation marks, e.g. "*Rotalia*" *beccari* Zone.

CHAPTER 8 Magnetostratigraphic Polarity Units

A. Nature of Magnetostratigraphic Polarity Units

When measurable magnetic properties of rocks vary stratigraphically they may be the bases for related but different kinds of stratigraphic units known collectively as “magnetostratigraphic units” (“magnetozones”).

The magnetic property most useful in stratigraphic work is the change in the direction of the remanent magnetization of the rocks, caused by reversals in the polarity of the Earth’s magnetic field. Such reversals of the polarity have taken place many times during geologic history. They are recorded in the rocks because the rocks become magnetized in the direction of the Earth’s magnetic field at the time of their formation. The direction of the remanent magnetic polarity recorded in the stratigraphic sequence can be used as the basis for the subdivision of the sequence into units characterized by their magnetic polarity. Such units are called “magnetostratigraphic polarity units”. A magnetostratigraphic polarity unit is present only where this property can be identified in the rocks.

The positive direction of magnetization of a rock is, by definition, its “north-seeking magnetization” (it points toward the Earth’s present magnetic North Pole), and the rock is said to have “normal magnetization”, or “normal polarity”. Conversely, if it points to the present magnetic South Pole, the rock is said to have “reversed magnetization”, or “reversed polarity”. Magnetostratigraphic polarity units are, therefore, either normal or reversed.

A problem arises because the north paleomagnetic pole is believed to have crossed the geographic equator in Paleozoic time, so that for some lower Paleozoic and older rocks it is unclear which is the direction of the North Pole and which the South Pole. Polarity must in these cases be defined with respect to the apparent polar wander path (APWP) for the crustal plate where it is found. If the direction of magnetization of a rock unit indicates a paleomagnetic pole that falls on the APWP that terminates at the present North Pole, the rock unit has *normal* polarity; if the magnetization is directed 180 from this, it has *reversed* polarity.

Magnetostratigraphic polarity units have been established in two ways: 1) combining the determination of the orientation of the remanent magnetization of sedimentary or volcanic rocks from outcrops or cored sections with their age determined by isotopic or biostratigraphic methods; 2) through the use of shipboard magnetometer profiles from ocean surveys to identify and correlate linear magnetic anomalies that are interpreted as reflecting reversals of the Earth’s magnetic field, recorded in the lava of the sea floor during the sea-floor-spreading process. It has been shown that the two kinds of investigation are correlative and record the same causative process.

The first type may be handled by using normal stratigraphic procedures. Units of the second type, currently identified by “anomaly numbers”, are deduced from a remotely obtained record of the overall variations of the geomagnetic field from unseen rocks on or below the sea floor. Marine magnetic anomalies are, thus, not true conventional stratigraphic units. However, they are useful units in the reconstruction of continental plate motions and in the interpretation of the geologic history of the ocean basins.

The relation of magnetostratigraphic polarity units to other kinds of stratigraphic units is discussed in Chapter 10.

B. Definitions

1. **Magnetostratigraphy.** The element of stratigraphy that deals with the magnetic characteristics of rock bodies.

2. **Magnetostratigraphic classification.** The organization of rock bodies into units based on differences in magnetic character.

3. **Magnetostratigraphic unit (magnetozone).** A body of rocks unified by similar magnetic characteristics which allow it to be differentiated from adjacent rock bodies.

4. **Magnetostratigraphic polarity classification.** The organization of rock bodies into units based on changes in the polarity of their remanent magnetization related to reversals in the polarity of the Earth’s magnetic field.

5. **Magnetostratigraphic polarity unit.** A body of rocks characterized by its magnetic polarity that allows it to be differentiated from adjacent rock bodies.

6. **Magnetostratigraphic polarity-reversal horizons and polarity-transition zones.** Magnetostratigraphic polarity-reversal horizons are surfaces or thin transition intervals across which the magnetic polarity reverses. Where the polarity change takes place through a substantial interval of strata, of the order of 1 m in thickness, the term “magnetostratigraphic polarity transition-zone” should be used. Magnetostratigraphic polarity-reversal horizons and polarity-transition zones provide the boundaries for magnetostratigraphic polarity units.

C. Kinds of Magnetostratigraphic Polarity Units

The basic formal unit in magnetostratigraphic polarity classification is the *magnetostratigraphic polarity zone*, or simply *polarity zone*. Polarity zones may be subdivided into *polarity subzones* and grouped into *polarity superzones*.

Magnetostratigraphic polarity zones may consist of bodies of strata unified by 1) a single polarity of magnetization; 2) an intricate alternation of normal and reversed polarity of magnetization; 3) having dominantly either normal or reversed polarity, but with minor intervals of the opposite polarity.

D. Procedures for Establishing Magnetostratigraphic Polarity Units

See section 3.B. Standards of reference and stratotypes for polarity units require special treatment. The standard of reference for the definition and recognition of a magnetostratigraphic polarity unit for land-based units is a designated stratotype in a continuous sequence of strata that shows its polarity pattern throughout and clearly defines its upper and lower limits by means of boundary stratotypes. These are marked with artificial permanent markers to facilitate restudy.

The standard of reference of marine-based units is a designated profile along a designated traverse with all instrumental and guidance conditions specified. This pattern of polarity reversals from the ocean floor should be dated by extrapolation and interpolation from isotopic and paleontologic information.

E. Procedures for Extending Magnetostratigraphic Polarity Units

A magnetostratigraphic polarity unit and its boundaries may be extended away from its type locality or stratotype only as far as the magnetic properties and stratigraphic position of the unit can be identified.

F. Naming of Magnetostratigraphic Polarity Units

See section 3.B.3. The formal name of a magnetostratigraphic polarity unit is formed from the name of an appropriate geographic feature combined with a term indicating its rank and direction of polarity, e.g. Jaramillo Normal Polarity Zone. The currently well-established names derived from the names of distinguished contributors to the science of geomagnetism (for example, Brunhes, Gauss, Matuyama) should not be replaced.

Numbered or lettered units may be used informally, but this is not recommended as a general practice. However, the classic linear magnetic anomalies of the ocean floor are excepted, because of their historical importance and dominance in the literature.

The time interval represented by a magnetostratigraphic polarity unit is called a *chron* (*superchron* or *subchron* if necessary). *Chronozone* is the term used to refer to the rocks formed anywhere during a particular magnetostratigraphic polarity chron (Table 2).

Table 2 Recommended Terminology for Magnetostratigraphic Polarity Units.

Magnetostratigraphic polarity units	Chronostratigraphic equivalent	Geochronologic equivalent
Polarity superzone	Chronozone (or superchronozone)	Chron (or superchron)
Polarity zone	Chronozone	Chron
Polarity subzone	Chronozone (or subchronozone)	Chron (or subchron)

G. Revision of Magnetostratigraphic Polarity Units

See Section 3.B.5.

CHAPTER 9 Chronostratigraphic Units

A. Nature of Chronostratigraphic Units

Chronostratigraphic units are bodies of rocks, layered or unlayered, that were formed during a specified interval of geologic time. The units of geologic time during which chronostratigraphic units were formed are called *geochronologic units*.

The relation of chronostratigraphic units to other kinds of stratigraphic units is discussed in Chapter 10.

B. Definitions

1. **Chronostratigraphy.** The element of stratigraphy that deals with the relative time relations and ages of rock bodies.

2. **Chronostratigraphic classification.** The organization of rocks into units on the basis of their age or time of origin.

The purpose of chronostratigraphic classification is to organize systematically the rocks forming the Earth's crust into named units (chronostratigraphic units) corresponding to intervals of geologic time (geochronologic units) to serve as a basis for time-correlation and a reference system for recording events of geologic history.

3. **Chronostratigraphic unit.** A body of rocks that includes all rocks formed during a specific interval of geologic time, and only those rocks formed during that time span. Chronostratigraphic units are bounded by synchronous horizons. The rank and relative magnitude of the units in the chronostratigraphic hierarchy are a function of the length of the time interval that their rocks subtend, rather than of their physical thickness.

4. **Chronostratigraphic horizon (Chronohorizon).** A stratigraphic surface or interface that is synchronous, everywhere of the same age.

C. Kinds of Chronostratigraphic Units

1. **Hierarchy of formal chronostratigraphic and geochronologic unit terms.** The *Guide* recommends the following formal chronostratigraphic terms and geochronologic equivalents to express units of different rank or time scope (Table 3).

Position *within* a chronostratigraphic unit is expressed by adjectives indicative of position such as: basal, lower, middle, upper, etc.; position within a geochronologic unit is expressed by temporal adjectives such as: early, middle, late, etc.

2. **Stage (and Age).** The stage has been called the basic working unit of chronostratigraphy because it is suited in scope and rank

Table 3 Conventional Hierarchy of Formal Chronostratigraphic and Geochronologic Terms.

Chronostratigraphic	Geochronologic
Eonothem	Eon
Erathem	Era
System*	period*
Series*	Epoch*
Stage†	Age
Substage	Subage or Age

* If additional ranks are needed, the prefixes sub and super may be used with these terms.

† Several adjacent stages may be grouped into a superstage (see Section 9.C.3).

to the practical needs and purposes of intraregional chronostratigraphic classification.

a. **Definition.** The *stage* includes all rocks formed during an *age*. A stage is normally the lowest ranking unit in the chronostratigraphic hierarchy that can be recognized on a global scale. It is a subdivision of a series.

b. **Boundaries and stratotypes.** A stage is defined by its boundary stratotypes, sections that contain a designated point in a stratigraphic sequence of essentially continuous deposition, preferably marine, chosen for its correlation potential.

The selection of the boundaries of the stages of the Standard Global Chronostratigraphic Scale deserves particular emphasis because such boundaries serve to define not only the stages but also chronostratigraphic units of higher rank, such as series and systems.

c. **Time span.** The lower and upper boundary stratotypes of a stage represent specific moments in geologic time, and the time interval between them is the time span of the stage. Currently recognized stages vary in time span, but most range between 2 and 10 million years. The thickness of the strata in a stage and its duration in time are independent variables of widely varying magnitudes.

d. **Name.** The name of a stage should be derived from a geographic feature in the vicinity of its stratotype or type area. In English, the adjectival form of the geographic term is used with an ending in "ian" or "an". The age takes the same name as the corresponding stage.

3. Substage and Superstage

A *substage* is a subdivision of a stage whose equivalent geochronologic term is *subage*. Adjacent stages may be grouped into a *superstage*. Names of substages and superstages follow the same rules as those of stages.

4. Series (and Epoch)

a. **Definition.** The *series* is a chronostratigraphic unit ranking above a stage and below a system. The geochronologic equivalent of a series is an *epoch*. The terms *superseries* and *subseries* have been used only infrequently.

b. **Boundaries and boundary-stratotypes.** Series are defined by boundary stratotypes (see section 9.H).

c. **Time span.** See section 9.D. The time span of currently accepted series ranges from 13 to 35 million years.

d. **Name.** A new series name should be derived from a geographic feature in the vicinity of its stratotype or type area. The names of most currently recognized series, however, are derived from their position within a system: lower, middle, upper. Names of geographic origin should preferably be given the ending "ian" or "an". The epoch corresponding to a series takes the same name as the series except that the terms "lower" and "upper" applied to a series are changed to "early" and "late" when referring to an epoch.

e. **Misuse of "series".** The use of the term "series" for a lithostratigraphic unit more or less equivalent to a group *should be discontinued*.

5. System (and Period)

a. **Definition.** A *system* is a unit of major rank in the conventional chronostratigraphic hierarchy, above a series and below an

erathem. The geochronologic equivalent of a system is a *period*. Occasionally, the terms *subsystem* and *supersystem* have been used.

b. **Boundaries and boundary-stratotypes.** The boundaries of a system are defined by boundary-stratotypes (see section 9.H).

c. **Time span.** The time span of the currently accepted Phanerozoic systems ranges from 30 to 80 million years, except for the Quaternary System that has a time span of only about 1.64 million years.

d. **Name.** The names of currently recognized systems are of diverse origin inherited from early classifications: some indicate chronologic position (Tertiary, Quaternary), others have lithologic connotation (Carboniferous, Cretaceous), others are tribal (Ordovician, Silurian), and still others are geographic (Devonian, Permian). Likewise, they bear a variety of endings such as “an”, “ic”, and “ous”. There is no need to standardize the derivation or orthography of the well-established system names. The period takes the same name as the system to which it corresponds.

6. Erathem (and Era)

An *erathem* consists of a group of systems. The geochronologic equivalent of an erathem is an *era*. The names of erathems were chosen to reflect major changes of the development of life on the Earth: Paleozoic (old life), Mesozoic (intermediate life), and Cenozoic (recent life). Eras carry the same name as their corresponding erathems.

7. Eonothem (and Eon)

An *eonothem* is a chronostratigraphic unit greater than an erathem. The geochronologic equivalent is an *eon*. Three eonothems are generally recognized, from older to younger, the Archean, Proterozoic and Phanerozoic eonothems. The combined first two are usually referred to as the Precambrian. The eons take the same name as their corresponding eonothems.

8. Nonhierarchical formal chronostratigraphic units—the Chronozone.

a. **Definition.** A *chronozone* is a formal chronostratigraphic unit of unspecified rank, not part of the hierarchy of conventional chronostratigraphic units. It is the body of rocks formed anywhere during the time span of some designated stratigraphic unit or geologic feature. The corresponding geochronologic unit is the *chron*.

b. **Time span.** The time span of a chronozone is the time span of a previously designated stratigraphic unit or interval, such as a lithostratigraphic, biostratigraphic, or magnetostratigraphic polarity unit. It should be recognized, however, that while the stratigraphic unit on which the chronozone is based extends geographically only as far as its diagnostic properties can be recognized, the corresponding chronozone includes all rocks formed everywhere during the time span represented by the designated unit. For instance, a formal chronozone based on the time span of a biozone includes all strata equivalent in age to the total maximum time span of that biozone regardless of the presence or absence of fossils diagnostic of the biozone (Figure 8).

Chronozones may be of widely different time spans. The designation of the boundaries of a chronozone and of its time span can be done in several ways depending on the nature of the stratigraphic unit on which the chronozone is based. If the unit has a designated stratotype, the boundaries and time span of the chronozone can be made to correspond either to those of the unit at its stratotype or to the total time span of the unit, which may be longer than that at the stratotype. In this second case, the boundaries and time span of the chronozone would vary with increasing information concerning the time span of the unit. If the unit on which the chronozone is based is of the type which cannot appropriately have a designated stratotype, such as a biostratigraphic unit, its time span cannot be defined either because the time span of the reference unit may change with increasing information (see section 7.A).

c. **Geographic extent.** The geographic extent of a chronozone is, in theory, worldwide, but its applicability is limited to the area over which its time span can be identified, which is usually less.

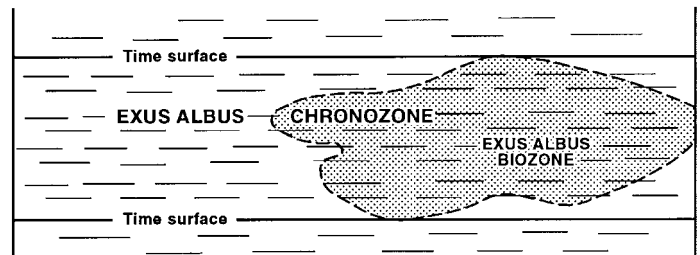

Figure 8 Relation between Exus albus Chronozone and Exus albus Biozone. (Distribution of specimens of Exus albus shown by dot-pattern.)

d. **Name.** A chronozone takes its name from the stratigraphic unit on which it is based, e.g., *Exus albus* Chronozone, based on the *Exus albus* Range Zone.

D. The Standard Global Chronostratigraphic (Geochronologic) Scale

1. Concept

A major goal of chronostratigraphic classification is the establishment of a hierarchy of chronostratigraphic units of worldwide scope, which will serve as a standard scale of reference for the dating of all rocks everywhere and for relating all rocks everywhere to world geologic history (See section 9.B.2). All units of the standard chronostratigraphic hierarchy are theoretically worldwide in extent, as are their corresponding time spans.

2. Present status

Table 4 shows the Standard Global Chronostratigraphic (Geochronologic) Scale of common current usage. Numerical ages taken from recently published geologic time scales are added. Only the major units for which there is general agreement are shown.

E. Regional Chronostratigraphic Scales

The units of the Standard Global Chronostratigraphic (Geochronologic) Scale are valid only as they are based on sound, detailed local and regional stratigraphy. Accordingly, the route toward recognition of uniform global units is by means of local or regional stratigraphic scales. Moreover, regional units will probably always be needed whether or not they can be correlated with the standard global units. It is better to refer strata to local or regional units with accuracy and precision rather than to strain beyond the current limits of time correlation in assigning these strata to units of a global scale. Local or regional chronostratigraphic units are governed by the same rules as are established for the units of the Standard Global Chronostratigraphic Scale.

F. Subdivision of the Precambrian

The Precambrian has been subdivided into arbitrary geochronometric units, but it has not been subdivided into chronostratigraphic units recognizable on a global scale.

There are prospects that chronostratigraphic subdivision of much of the Precambrian may eventually be attained through isotopic dating and through other means of time correlation. However, the basic principles to be used in subdividing the Precambrian into major chronostratigraphic units should be the same as for Phanerozoic rocks, even though different emphasis may be placed on various means of time correlation, predominantly isotopic dating.

Table 4 Major Units of the Standard Global Chronostratigraphic (Geochronologic) Scale (1)

Eonothem (Eon)	Erathem (Era)	System and Subsystem (Period and Subperiod)		Series (Epoch)	Numerical Age (Ma)				
					(2)	(3)	(4)		
PHANEROZOIC	Cenozoic	Quaternary		Holocene	1.60	23.	1.64		
				Pleistocene					
		Tertiary	Neogene			Pliocene	23.7	23.	23.3
						Miocene			
						Oligocene			
			Paleogene			Eocene	66.4	65	65
						Paleocene			
						Upper			
		Mesozoic	Cretaceous		Lower	144	135	145.8	
					Upper				
	Jurassic		Middle	208	205	208			
			Lower						
			Upper						
	Triassic		Middle	245	250	245			
			Lower						
	Permian		Upper	286	300	290			
			Lower						
	Paleozoic		Carboniferous (5)			360	355	362.5	
				Upper					
		Devonian		Middle	408	410	408.5		
				Lower					
		Silurian			438	438	439		
				Upper					
		Ordovician		Middle	505	510	510		
				Lower					
		Cambrian			570	570	570		
PRECAMBRIAN	PROTEROZ.			2500		2500			
	ARCHEAN								

- (1) A number of more detailed chronostratigraphic or geochronological scales have been published in the last 10-15 years including those of Palmer (1983) and Harland *et al.* (1982, 1990), referenced below, and the 1989 Global Stratigraphic Chart of the International Commission on Stratigraphy (Episodes, v. 12, no. 2).
- (2) Palmer, A.R., 1983, The Decade of North American Geology 1983 Geologic Time Scale
- (3) Snelling, N.J., 1987, Measurement of geological time and the Geological Time Scale
- (4) Harland, W.B., *et al.*, 1990, A Geologic Time Scale 1989
- (5) In North America, in place of a Carboniferous System, two systems have been recognized: Mississippian System (older) and Pennsylvanian System (younger). These are also sometimes known as subsystems of the Carboniferous System.

G. Quaternary Chronostratigraphic Units

The basic principles used in subdividing the Quaternary into chronostratigraphic units are the same as for other Phanerozoic chronostratigraphic units, although the methods of time correlation may have a different emphasis. As in the case of other chronostratigraphic units, those of the Quaternary require boundary definitions and designation of boundary stratotypes.

H. Procedures for Establishing Chronostratigraphic Units

See also section 3.B.

1. Boundary stratotypes as standards

The essential part of the definition of a chronostratigraphic unit is the time span during which the unit described was formed. Since

the only record of geologic time and of the events of geologic history lies in the rocks themselves, the best standard for a chronostratigraphic unit is a body of rocks formed between two designated instants of geologic time.

For these reasons, the boundaries of a chronostratigraphic unit of any rank are defined by two designated reference points in the rock sequence. The two points are located in the boundary-stratotypes of the chronostratigraphic unit which need not be part of a single section. Both, however, should be chosen in sequences of essentially continuous deposition since the reference points for the boundaries should represent points in time as specific as possible (see section 9.H.3).

2. Advantage of defining chronostratigraphic units by their lower boundary stratotypes

The definition of a chronostratigraphic unit places emphasis in the selection of the boundary-stratotype of its lower boundary; its upper boundary is defined as the lower boundary of the succeeding unit. This procedure avoids gaps and overlaps in the Standard Global Chronostratigraphic Scale. For example, should it be shown that the selected horizon is at the level of an undetected break in the sequence, then the missing span of geologic history would belong to the lower unit by definition and ambiguity is avoided.

3. Requirements for the selection of boundary stratotypes of chronostratigraphic units

Chronostratigraphic units offer the best promise of being identified, accepted, and used globally and of being, therefore, the basis for international communication and understanding because they are defined on the basis of their time of formation, a universal property. Particularly important in this respect are the units of the Standard Global Chronostratigraphic (Geochronologic) Scale. The term "Global Boundary Stratotype Section and Point" (GSSP) has been proposed for the standard boundary-stratotypes of the units of this scale.

In addition to the general requirements for the selection and description of stratotypes (section 4.C), boundary-stratotypes of chronostratigraphic units should fulfill the following requirements:

- The boundary-stratotypes must be selected in sections representing essentially continuous deposition. The worst possible choice for a boundary-stratotype of a chronostratigraphic unit is at an unconformity.
- The boundary-stratotypes of Standard Global Chronostratigraphic Units should be in marine, fossiliferous sections without major vertical lithofacies or biofacies changes. Boundary stratotypes of chronostratigraphic units of local application may need to be in a nonmarine section.
- The fossil content should be abundant, distinctive, well preserved, and represent a fauna and/or flora as cosmopolitan and as diverse as possible.
- The section should be well exposed and in an area of minimal structural deformation or surficial disturbance, metamorphism and diagenetic alteration, and with ample thickness of strata below, above and laterally from the selected boundary-stratotype.
- Boundary stratotypes of the units of the Standard Global Chronostratigraphic Scale should be selected in easily accessible sections that offer reasonable assurance of free study, collection, and long-range preservation. Permanent field markers are desirable.
- The selected section should be well studied and collected and the results of the investigations published, and the fossils collected from the section securely stored and easily accessible for study in a permanent facility.
- The selection of the boundary stratotype, where possible, should take account of historical priority and usage and should approximate traditional boundaries.
- To insure its acceptance and use in the Earth sciences, a boundary stratotype should be selected to contain as many specific

marker horizons or other attributes favorable for long-distance time correlation as possible.

The IUGS International Commission on Stratigraphy is the body responsible for coordinating the selection and approval of GSSPs of the units of the Standard Global Chronostratigraphic (Geochronologic) Scale.

I. Procedures for Extending Chronostratigraphic Units—Chronocorrelation (Time Correlation)

The boundaries of chronostratigraphic units are synchronous horizons by definition. In practice, the boundaries are synchronous only so far as the resolving power of existing methods of time correlation can prove them to be so. All possible lines of evidence should be utilized to extend chronostratigraphic units and their boundaries. Some of the most commonly used are:

1. Physical Interrelations of strata

The Law of Superposition states that in an undisturbed sequence of sedimentary strata the uppermost strata are younger than those on which they rest. The determination of the order of superposition provides unequivocal evidence for relative age relations. All other methods of relative age determination are dependent on the observed physical sequence of strata as a check on their validity. For a sufficiently limited distance, the trace of a bedding plane is the best indicator of synchronicity.

2. Lithology

Lithologic properties are commonly influenced more strongly by local environment than by age, the boundaries of lithostratigraphic units eventually cut across synchronous surfaces, and similar lithologic features occur repeatedly in the stratigraphic sequence. Even so, a lithostratigraphic unit always has some chronostratigraphic connotation and is useful as an approximate guide to chronostratigraphic position, especially locally. Distinctive and widespread lithologic units also may be diagnostic of chronostratigraphic position.

3. Paleontology

The orderly and progressive course of organic evolution is irreversible with respect to geologic time and the remains of life are widespread and distinctive. For these reasons, fossil taxa, and particularly their evolutionary sequences, constitute one of the best and most widely used means of tracing and correlating beds and determining their relative age.

Biostratigraphic correlation, however, is not time correlation because homotaxy between samples may result from other causes than that the samples are equal in age.

4. Isotopic age determinations

Isotopic dating methods (U-Pb, Rb-Sr, K-Ar, Ar-Ar) based on the radioactive decay of certain parent nuclides at a rate that is constant and suitable for measuring geologic time provide chronostratigraphic data of high precision with analytical errors in the range of 0.1 to 2 percent. However, not all rock types and minerals are amenable to isotopic age determination.

Isotopic dating contributes age values expressed in years and it provides the major hope for working out the ages and age relationships of Precambrian rocks. In some circumstances, isotopic age determinations provide the most accurate or even the only basis for age determination and chronostratigraphic classification of sedimentary, volcanic and other igneous rocks.

Discrepancies in age results may arise from the use of different decay constants. It is important to geological comparisons, therefore, that the uniform sets of decay constants recommended by the IUGS Subcommittee on Geochronology be used.

A method of age determination through radioactivity differing from those mentioned above is that based on the proportion of the

radiocarbon isotope (^{14}C) to normal carbon in the organic matter of sediments. This method has been extremely valuable but is limited in application to the dating of upper Quaternary strata.

5. Geomagnetic polarity reversals

Periodic reversals of the polarity of the Earth's magnetic field are utilized in chronostratigraphy, particularly in upper Mesozoic and Cenozoic rocks where a magnetic time scale has been developed. Polarity reversals are, however, binary and specific ones cannot be identified without assistance from some other method of dating such as biostratigraphy or isotopic dating.

6. Paleoclimatic change

Climatic changes leave imprints on the geological record in the form of glacial deposits, evaporites, red beds, coal deposits, faunal changes, etc. Their effects on the rocks may be local or widespread and provide valuable information for chronocorrelation, but they must be used in combination with other specific methods.

7. Paleogeography and eustatic changes in sea level

As a result of either epeirogenic movements of the land masses or eustatic rises and lowerings of the sea level, certain periods of Earth history are characterized worldwide by a general high or low stand of the continents with respect to sea level. The evidence in the rocks of the resulting transgressions, regressions, and unconformities can furnish an excellent basis for establishing a worldwide chronostratigraphic framework. The identification of a particular event, however, is complicated by local vertical movements and so the method requires auxiliary help in order to identify the events correctly.

8. Unconformities

Even though a surface of unconformity varies in age and time-value from place to place and is never universal in extent, certain unconformities may serve as useful guides to the approximate placement of chronostratigraphic boundaries. Unconformities, however, cannot fulfill the requirements for the selection of such boundaries (see section 9.H.3).

9. Orogenies

Crustal disturbances have a recognizable effect on the stratigraphic record. However, the considerable duration of many orogenies, their local rather than worldwide nature, and the difficulty of precise identification make them unsatisfactory indicators of worldwide chronostratigraphic correlation.

10. Other indicators

Many other lines of evidence may in some circumstances be helpful as guides to time-correlation and as indicators of chronostratigraphic position. Some are more used than others, but none should be rejected.

J. Naming of Chronostratigraphic Units

A formal chronostratigraphic unit is given a binomial designation - a proper name plus a term-word - and the initial letters of both are capitalized. Its geochronologic equivalent uses the same proper name combined with the equivalent geochronologic term, e.g., Cretaceous System - Cretaceous Period. The proper name of a chronostratigraphic or geochronologic unit may be used alone where there is no danger of confusion, e.g. "the Aquitanian" in place of "the Aquitanian Stage". See sections 3.B.3 and 3.B.4.

K. Revision of Chronostratigraphic Units

See sections 3.B and 9.H.

CHAPTER 10 Relation Between Different Kinds of Stratigraphic Units

The categories within stratigraphic classification are all closely related. All deal with the rocks of the Earth's crust, with the picture of the stratified Earth, and with the history of the Earth as interpreted from its rock bodies. Each category, however, is concerned with a different property or attribute of the rocks and a different aspect of Earth history. The relative importance of the different categories varies with the circumstances. Each is important for particular purposes.

Lithostratigraphic units are the basic units of geologic mapping. Wherever there are rocks, it is possible to develop a lithostratigraphic classification. Lithostratigraphic units are based on the lithologic character of rocks. Fossils may be an important distinguishing element in their recognition, but only because of their diagnostic lithologic characterization.

Inasmuch as each lithostratigraphic unit was formed during a specific interval of geologic time, it has chronostratigraphic significance. The concept of time, however, plays little part in establishing or identifying lithostratigraphic units and their boundaries. Lithologic character is influenced more strongly by conditions of formation than by time of origin; nearly identical rock types are repeated time and again in the stratigraphic sequence, and the boundaries of almost all lithostratigraphic units cut across synchronous surfaces when traced laterally.

Biostratigraphic classification is also an early step in working out the stratigraphy of a region. *Biostratigraphic units* are based on the fossil content of the rocks. The selection and establishment of biostratigraphic units are not determined by the lithologic composition of the strata, except that the presence or absence of fossils and the kind of fossils present, may be related to the type and lithofacies of the rocks in which they are found.

Biostratigraphic units are distinct from other kinds of stratigraphic units in that the organisms whose fossil remains define them show evolutionary changes through geologic time that are not repeated in the stratigraphic record. This makes the fossil assemblages of any one age distinctive from any other.

Lithostratigraphic and biostratigraphic units are fundamentally different kinds of stratigraphic units based on different distinguishing criteria. Their boundaries may coincide locally, but commonly they lie at different stratigraphic horizons or cross each other. Whereas lithostratigraphic classification is possible for any body of rock, biostratigraphic classification is possible only for fossiliferous rocks that bear identifiable fossils.

Both lithostratigraphic and biostratigraphic units reflect the environment of deposition, but biostratigraphic units are more influenced by, and indicative of, geologic age. They are also less repetitive in character because they are based on irreversible evolutionary change.

Lithostratigraphic and biostratigraphic units are indispensable objective units, essential in picturing the lithologic constitution and geometry of the rocks of the Earth's crust and the development of life and past environments on the Earth.

Unconformity-bounded units and *magnetostratigraphic polarity units*, like biostratigraphic units, can be established only when the diagnostic properties on which they are based are present in the rocks.

Unconformity-bounded units may include a number of other kinds of stratigraphic units, both in vertical and lateral succession. Similarly, an unconformity-bounded unit may represent all or parts of several chronostratigraphic units. In special cases, the boundaries of an unconformity-bounded unit may coincide with the boundaries of other kinds of stratigraphic units. However, the boundaries of unconformity-bounded units are always diachronous to a lesser or greater extent, and so never correspond with the boundaries of chronostratigraphic units.

Magnetostratigraphic polarity units while similar to lithostratigraphic and biostratigraphic units in that they are based only on a directly determinable property of the rocks, their magnetic polarity, are different from them because magnetostratigraphic polarity units are potentially recognizable globally and, in this respect, they are similar to chronostratigraphic units.

The changes in magnetic polarity are the result of very rapid worldwide reversals of the Earth's magnetic field, generally occurring through a time span of no more than about 5,000 years. The magnetic-polarity-reversal horizons produced as a result of these events do not, therefore, constitute synchronous horizons. Consequently, the body of rocks lying between magnetic-polarity reversals horizons produced by two successive polarity reversals constitutes a polarity unit containing everywhere strata representing essentially, but not exactly, the same time span. Such units *may closely approximate* chronostratigraphic units, but they are not chronostratigraphic units because they are defined primarily *not by the record of time* but by a specific physical character, the change in the polarity of remanent magnetization, which is not instantaneous.

Moreover, because of the variability in the distinctness of the imprint or in the preservation of the polarity record, because of unconformities in the section, because of the effects of bioturbation, or because of possibilities of subsequent remagnetization, or for other reasons, the boundaries of a polarity unit depart from synchronicity.

Although magnetostratigraphic-polarity horizons and units may be useful *guides* to chronostratigraphic position, they have relatively little individuality, one reversal looks like another, and can usually be identified only by supporting age evidence, such as paleontologic or isotopic data.

Chronostratigraphic units are defined as encompassing all rocks formed within certain time spans of Earth history regardless of their compositions or properties. By definition, these units everywhere include rocks of only a certain age and their boundaries are everywhere synchronous. This is in contrast with lithostratigraphic units that can be objectively recognized wherever there are rocks, and with biostratigraphic, magnetostratigraphic polarity, and unconformity-bounded units that are limited by the occurrence of specific properties or attributes of the rocks. Whereas other kinds of stratigraphic units are distinguished, established, and identified on the basis of observable physical features, chronostratigraphic units are

distinguished, established, and identified on the basis of their time of formation—an abstract character—as interpreted from these observable properties.

Biostratigraphic units may approximate chronostratigraphic units even over wide areas, but the boundaries of biostratigraphic units may diverge from those of a chronostratigraphic unit for many reasons. Principal among these are changes in depositional facies, variations in conditions for fossilization and preservation of fossils, vagaries of fossil discovery, and biogeographic differences. Biostratigraphic units cannot be recognized in rocks where there are no fossils.

Some lithostratigraphic units are excellent guides to approximate time correlation over large areas, as in the case of volcanic ash beds, but they, like biostratigraphic units, are not chronostratigraphic units because they are not bounded everywhere by synchronous surfaces.

Unconformity-bounded units and magnetostratigraphic polarity units also provide valuable support for the development of chronostratigraphic classification. Especially, the boundaries of magnetostratigraphic polarity units because they record the very rapid reversal of the Earth's magnetic field, approach synchronous surfaces closer than any other kind of objective stratigraphic unit. If properly identified, they offer a sound foundation for global time correlation and chronostratigraphic classification.

Chronostratigraphic classification stands out as the basis to reach the ultimate goal of stratigraphy. Chronostratigraphic units, as divisions of rock bodies based on geologic time, are in principle worldwide in extent, and important in providing a worldwide basis for communication and understanding.

The above-mentioned kinds of stratigraphic units and their corresponding fields of stratigraphic investigation are the most commonly used. However, there are many other fruitful lines of stratigraphic endeavor and many other kinds of stratigraphic units which, under appropriate circumstances and for certain objectives, are useful. Thus, we may find it useful to recognize stratigraphic units or horizons based on electric-log characters, seismic properties, chemical changes, stable isotope analyses, or any of many other properties of rock bodies. No one can or need use all the possible kinds of stratigraphic tools or units that are potentially available, but the way should be kept open within the definition and scope of stratigraphy to apply any that give promise of being useful.

Michael A. Murphy is Professor Emeritus, now at the University of California, Davis. His research has centered on Silurian, Devonian, and Cretaceous biostratigraphy and evolutionary patterns of conodonts, graptolites, and ammonites and the techniques of sequencing and correlating stratigraphic data. He is Past-Chairman of the International Subcommission on Stratigraphic Classification of the IUGS International Commission on Stratigraphy.

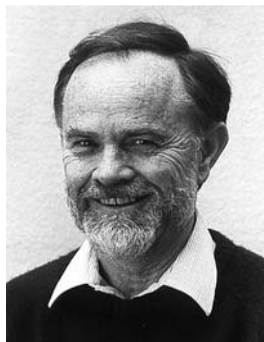

Amos Salvador was Chairman of the International Subcommission on Stratigraphic Classification of the IUGS International Commission on Stratigraphy from 1976 to 1992, and Editor of the Subcommission's second edition of the *International Stratigraphic Guide* (1994). After a 35-year career in the petroleum industry, he joined the University of Texas at Austin in 1980 to teach petroleum geology, energy resources, and various aspects of stratigraphy. Since 1993, as Professor Emeritus, his research has been dedicated to the estimation of energy demand and supply and to matters of stratigraphic classification and terminology.

