

# ***ERDAS IMAGINE Tour Guides™***

***ERDAS IMAGINE® V8.5***

***ERDAS® , Inc.  
Atlanta, Georgia***

Copyright © 1991-2001 by ERDAS<sup>®</sup>, Inc. All Rights Reserved.

Printed in the United States of America.

ERDAS Proprietary - Delivered under license agreement.  
Copying and disclosure prohibited without express written permission from ERDAS, Inc.

ERDAS Worldwide Headquarters  
2801 Buford Highway, NE  
Atlanta, Georgia 30329-2137 USA  
www.erdas.com  
Toll Free: 877/GO ERDAS (463-7327)  
Phone: 404/248-9000  
Fax: 404/248-9400  
User Support: 404/248-9777

ERDAS in Europe, Africa, Middle East, Asia/Pacific Rim  
Phone: 011 44 1223 881 774  
Fax: 011 44 1223 880 160

All Other Worldwide Inquiries  
Phone: 404/248-9000  
Fax: 404/248-9400

### **Acknowledgments**

ERDAS would like to extend our thanks to the following data providers:

- U.S. Geological Survey, EROS Data Center, Sioux Falls, SD
- City of Oxford, OH - GeoOne, Inc.
- ESA/EURIMAGE, Rome, Italy - Distributed by NRSC

### **Warning**

All information in this document, as well as the software to which it pertains, is proprietary material of ERDAS, Inc., and is subject to an ERDAS license and non-disclosure agreement. Neither the software nor the documentation may be reproduced in any manner without the prior written permission of ERDAS, Inc.

Specifications are subject to change without notice.

### **Trademarks**

Copyright © 2001 ERDAS, Inc. All rights reserved. ERDAS, ERDAS IMAGINE, IMAGINE Advantage, IMAGINE Essentials, IMAGINE Professional and Stereo Analyst are registered trademarks of ERDAS, Inc. CellArray, IMAGINE Developers' Toolkit, IMAGINE Expert Classifier, IMAGINE IFSAR DEM, IMAGINE NITF, IMAGINE OrthoBASE, IMAGINE OrthoRadar, IMAGINE Radar Interpreter, IMAGINE Radar Mapping Suite, IMAGINE StereoSAR DEM, IMAGINE Subpixel Classifier, IMAGINE Vector, and IMAGINE VirtualGIS are trademarks of ERDAS, Inc. Other brand and product names are the properties of their respective owners. 5/01 Part No. 28.

# Table of Contents

Table of Contents .....	iii
List of Tables .....	xv
Preface .....	xvii
About This Manual .....	xvii
Example Data .....	xvii
Time Required .....	xvii
Documentation .....	xvii
Printed Documentation .....	xvii
On-Line Documentation .....	xviii
Documentation Functions .....	xix
Conventions Used in This Book .....	xx
Getting Started .....	xxi
ERDAS IMAGINE Icon Panel .....	xxi
ERDAS IMAGINE Menu Bar .....	xxi
Dialogs .....	xxx
More Information/Help .....	xxx
<b>Section I</b>	
<b>IMAGINE Essentials™ .....</b>	<b>1</b>
<b>CHAPTER 1</b>	
<b>Viewer .....</b>	<b>3</b>
Introduction .....	3
Display Preferences .....	3
Check Band-to-Color Gun Assignments .....	3
Display an Image .....	6
Display Options .....	8
Utility Menu Options .....	10
Use Inquiry Functions .....	10
Take Measurements .....	12
View Menu Options .....	14
Arrange Layers .....	14
Zoom .....	16
Animated Zoom .....	18
Box Zoom .....	19
Real-time Zoom .....	19
Display Two Images .....	19
Link Viewers .....	20
Compare Images .....	21
Unlink Viewers .....	21
Raster Menu Options .....	22

# Table of Contents

Create an AOI Layer .....	22
Adjust Image Contrast .....	26
Use Piecewise Linear Stretches .....	27
Manipulate Histogram .....	29
Adjust Shift/Bias .....	31
Use Mouse Linear Mapping .....	32
<b>Raster Editor .....</b>	<b>34</b>
Interpolate .....	35
Fill with Value .....	36
<b>Raster Attribute Editor .....</b>	<b>38</b>
Make Layers Transparent .....	39
Manipulate CellArray Information .....	41
Edit Column Properties .....	41
<b>Profile Tools .....</b>	<b>47</b>
Display Spectral Profile .....	47
Display Spatial Profile .....	50
View Surface Profile .....	52
<b>Image Drape .....</b>	<b>54</b>
Change Options .....	55
Change Sun Position .....	56
Dump Contents to Viewer .....	57
Start Eye/Target .....	57
Manipulate the Observer and Field of View .....	58
<b>CHAPTER 2</b>	
<b>Image Catalog .....</b>	<b>61</b>
Introduction .....	61
Set Catalog Preferences .....	61
Create an Image Catalog .....	62
Add Information .....	63
Perform Graphical Queries .....	64
Select Area .....	64
Run Query .....	65
View Information .....	67
Modify Views .....	67
Archive Data .....	69
<b>CHAPTER 3</b>	
<b>Map Composer .....</b>	<b>73</b>
Introduction .....	73
Create a Map .....	73
Start Map Composer .....	74
Prepare the Data Layers .....	76
Draw the Map Frame .....	76
Adjust the Size of the Map Frame .....	79
Adjust the Position of the Map Frame .....	80

# Table of Contents

Edit the Map Frame .....	81
Delete the Map Frame .....	82
Add a Neatline and Tick Marks .....	83
Change Text/Line Styles .....	85
Make Scale Bars .....	87
Create a Legend .....	88
Add a Map Title .....	90
Place a North Arrow .....	92
Write Descriptive Text .....	94
Save the Map Composition .....	95
Print the Map Composition .....	95
Edit Composition Paths .....	97
<b>CHAPTER 4</b>	
<b>Classification .....</b>	<b>101</b>
Introduction .....	101
Use Unsupervised Classification .....	101
Generate Thematic Raster Layer .....	102
Evaluate Classification .....	104
Create Classification Overlay .....	104
Analyze Individual Classes .....	106
<b>CHAPTER 5</b>	
<b>Vector Querying and Editing .....</b>	<b>109</b>
Introduction .....	109
Query Vector Data .....	109
Copy Vector Data .....	109
Display Vector Layers .....	111
Change Vector Properties .....	112
View Attributes .....	114
Use the Marquee Tools to Select Features .....	116
Use the Criteria Function .....	118
Edit Vector Layers .....	119
Create New Vector Layer .....	123
Create Attributes .....	127
Create a Simple Shapefile Layer .....	128
<b>CHAPTER 6</b>	
<b>Polynomial Rectification .....</b>	<b>135</b>
Introduction .....	135
Rectify a Landsat Image .....	135
Perform Image to Image Rectification .....	135
Display Files .....	135
Start GCP Tool .....	137
Select GCPs .....	140

# Table of Contents

Calculate Transformation Matrix from GCPs .....	146
Digitize Check Points .....	146
Resample the Image .....	148
Verify the Rectification Process .....	149
Rotate/Flip/Stretch Images .....	150
<b>CHAPTER 7</b>	
<b>Image Commands .....</b>	<b>153</b>
Introduction .....	153
Image Commands .....	153
<b>CHAPTER 8</b>	
<b>Import/Export .....</b>	<b>161</b>
Introduction .....	161
Import a SPOT Scene .....	161
Check Preview Options .....	163
Check Import Options .....	165
Export LAN Data .....	167
Create .tif Files .....	169
Import Generic Binary Data .....	173
Data View .....	174
Enter Image Dimensions .....	176
Save Options .....	177
Preview the Image .....	178
Get Image Information .....	178
Edit Image Information .....	178
View Image Information .....	179
<b>CHAPTER 9</b>	
<b>Batch Processing .....</b>	<b>181</b>
Introduction .....	181
Set up/Start the Scheduler on NT and 2000 .....	182
Use Batch with a UNIX System .....	183
Execute a Single File/Single Command .....	183
Execute Multiple Files/Single Command—Run Now .....	185
Set TIFF Image File Preferences .....	185
Start the Image Command Tool .....	186
Start the Batch Wizard .....	187
Execute Multiple Files/Single Command—Run Later .....	190
Add Multiple Files .....	192
Execute Multiple Files/Multiple Commands .....	195
Set Up .....	195
Run First Command .....	197
Run Next Command .....	197
Run Another Command .....	198
Create Variables .....	199

# Table of Contents

Modify Variables .....	200
Select Input Files .....	202
Set Start Time .....	203
<b>Work with Variables .....</b>	<b>204</b>
Create a New Variable .....	204
Prepare .....	204
Start Batch Wizard .....	205
Create a New Variable .....	206
Add Additional Files to the Batch Job .....	208
Start Processing .....	208
Check the Output Directory .....	209
<b>Additional Information .....</b>	<b>209</b>
Save/Load Options .....	209
Batch Job Files .....	210
<b>Section II</b>	
<b>IMAGINE Advantage™ .....</b>	<b>213</b>
<b>CHAPTER 10</b>	
<b>Fourier Transform Editor .....</b>	<b>215</b>
Introduction .....	215
Create an .fft Layer .....	215
Start the Fourier Transform Editor .....	218
<b>Edit Using Menu Options .....</b>	<b>221</b>
Use Low-Pass Filtering .....	221
Use a Circular Mask .....	227
Use a Rectangular Mask .....	229
Use a Wedge Mask .....	230
<b>Edit Using Mouse-Driven Tools .....</b>	<b>232</b>
Use Low-Pass Filtering .....	233
Use High-Pass Filtering .....	233
Apply a Wedge Mask .....	235
Combine Edits .....	236
<b>CHAPTER 11</b>	
<b>Image Interpreter .....</b>	<b>239</b>
Introduction .....	239
<b>Subsetting an Image .....</b>	<b>239</b>
Subsetting an Image Without Snapping .....	241
Subsetting an Image With Snap to Raster .....	245
<b>Apply Spatial Enhancement .....</b>	<b>247</b>
Apply Convolution .....	248
Check the File .....	250
Apply Crisp .....	251
View Results .....	253
<b>Apply Radiometric Enhancement .....</b>	<b>254</b>
Apply Brightness Inversion .....	255

# Table of Contents

Reverse	256
<b>Apply Spectral Enhancement</b>	<b>258</b>
Use Tasseled Cap	258
Check Results	260
Use the Indices Function	261
<b>CHAPTER 12</b>	
<b>Orthorectification</b>	<b>267</b>
Introduction	267
<b>Rectify a Camera Image</b>	<b>267</b>
Perform Image to Image Rectification	267
Check for Map Model	269
Perform Geometric Correction	270
Resample the Image	279
Calibrate the Image	280
<b>CHAPTER 13</b>	
<b>Terrain Surface Interpolation</b>	<b>283</b>
Introduction	283
<b>Create a Surface</b>	<b>283</b>
Import an ASCII File	284
Perform Surfacing	287
Display the Surface	288
<b>CHAPTER 14</b>	
<b>Mosaic</b>	<b>291</b>
Introduction	291
<b>Mosaic Using Air Photo Images</b>	<b>291</b>
Set Input Images	294
Identify Areas of Intersection	299
Draw a Cutline	300
Define Output Images	303
Run the Mosaic	304
Display the Mosaic	305
<b>Mosaic Using LANDSAT Images</b>	<b>306</b>
Display Input Images	306
Add Images for Mosaic	308
Stack Images	310
Match Images	310
Run the Mosaic	311
Display Output Image	312
<b>Mosaic Color Balancing Using Color Infrared Aerial Photos</b>	<b>314</b>
Add Images for Mosaic	316
Set Exclude Areas	317
Mosaic Color Balancing	319
Match Images	321
Run The Mosaic	322
Display Output Image	323





## CHAPTER 15

<b>Viewshed Analysis</b> .....	<b>325</b>
<b>Introduction</b> .....	<b>325</b>
<b>Create a Viewshed</b> .....	<b>325</b>
Start an Image Drape Viewer .....	326
Start the Viewshed Analysis Tool .....	327
Add First Observer .....	329
Add Another Observer .....	330
Link the Viewers and Set Eye and Target Positions .....	332
Save the Viewshed .....	333
Query Viewshed Data .....	334
Add Area Column to the CellArray .....	335
Query the Viewshed Layer .....	336
Finish .....	337

## Section III

<b>IMAGINE Professional™</b> .....	<b>339</b>
------------------------------------	------------

## CHAPTER 16

<b>Spatial Modeler</b> .....	<b>341</b>
<b>Introduction</b> .....	<b>341</b>
<b>Start Model Maker</b> .....	<b>341</b>
<b>Create Sensitivity Layer</b> .....	<b>342</b>
Define Input Slope Layer .....	344
Define Input Flood Plain Layer .....	349
Define Input Land Cover Layer .....	349
Define Function .....	351
Define Output Raster Layer .....	352
Save and Run the Model .....	353
<b>Enhance SPOT Data</b> .....	<b>354</b>
Define Input SPOT Layer .....	356
Define Input Convolution Kernel .....	356
Define Function .....	357
Define Output Raster Layer .....	358
Save and Run the Model .....	359
Combine Models .....	359
<b>Combine Sensitivity Layer with SPOT Data</b> .....	<b>360</b>
Define Input Scalar .....	361
Define Function .....	361
Define Output Raster Layer .....	363
Save and Run the Model .....	364
<b>Display New Layer</b> .....	<b>365</b>
Adjust Colors .....	366
<b>Test the Output</b> .....	<b>369</b>
<b>Add Annotation to a Model</b> .....	<b>370</b>
<b>Generate a Text Script</b> .....	<b>373</b>
<b>Print the Model</b> .....	<b>376</b>

# Table of Contents

<b>Apply the Criteria Function</b> . . . . .	<b>378</b>
Define Input Raster Layers . . . . .	380
Define Criteria . . . . .	380
Define Output Raster Layer . . . . .	382
<b>Minimizing Temporary Disk Usage</b> . . . . .	<b>384</b>
Set Preferences . . . . .	385
<b>Making Your Models Usable by Others</b> . . . . .	<b>386</b>
Prompt User . . . . .	386
Providing a User Interface to Your Model . . . . .	386
<b>Using Vector Layers in Your Model</b> . . . . .	<b>399</b>
Vector Layers as a Mask . . . . .	399
Add Attributes to Vector Layers . . . . .	411
<b>Debug Your Model</b> . . . . .	<b>418</b>
Eliminate Incomplete Definition . . . . .	418
Eliminate Object type Mismatch . . . . .	430
Eliminate Division by Zero . . . . .	444
Use AOIs in Processing . . . . .	449
<b>CHAPTER 17</b>	
<b>Advanced Classification</b> . . . . .	<b>455</b>
<b>Introduction</b> . . . . .	<b>455</b>
Supervised vs. Unsupervised Classification . . . . .	455
<b>Perform Supervised Classification</b> . . . . .	<b>455</b>
Define Signatures using Signature Editor . . . . .	456
Use Tools to Evaluate Signatures . . . . .	468
Perform Supervised Classification . . . . .	480
<b>Perform Unsupervised Classification</b> . . . . .	<b>484</b>
Generate Thematic Raster Layer . . . . .	485
<b>Evaluate Classification</b> . . . . .	<b>487</b>
Create Classification Overlay . . . . .	487
Analyze Individual Classes . . . . .	490
Use Thresholding . . . . .	492
Use Accuracy Assessment . . . . .	497
<b>CHAPTER 18</b>	
<b>IMAGINE Expert Classifier™</b> . . . . .	<b>503</b>
<b>Introduction</b> . . . . .	<b>503</b>
<b>Create a Knowledge Base</b> . . . . .	<b>503</b>
Set Up the Output Classes . . . . .	503
Enter Rules for the Hypothesis . . . . .	506
Add an Intermediate Hypothesis . . . . .	510
Copy and Edit . . . . .	512
Test the Knowledge Base . . . . .	514
<b>Create a Portable Knowledge Base</b> . . . . .	<b>519</b>
Data . . . . .	519
Methodology . . . . .	519
Open a Knowledge Base . . . . .	520

# Table of Contents

Examine the Knowledge Base	521
Derive Slope Values	522
Build Hypotheses	525
Set ANDing Criteria	527
Check Other Hypotheses	529
Introduce Spatial Logic to the Knowledge Base	529
Check Buildings Hypothesis	532
Identify Choke Points	533
Run the Expert Classification	536
Evaluate River Areas	538
Use Pathway Feedback	539
<b>Section IV</b>	
<b>IMAGINE Radar Interpreter™</b>	<b>543</b>
<b>CHAPTER 19</b>	
<b>IMAGINE Radar Interpreter™</b>	<b>545</b>
Introduction	545
<b>Suppress Speckle Noise</b>	<b>545</b>
Calculate Coefficient of Variation	549
Run Speckle Suppression Function	550
Use Histograms to Evaluate Images	552
<b>Enhance Edges</b>	<b>554</b>
<b>Enhance Image</b>	<b>557</b>
Wallis Adaptive Filter	557
Apply Sensor Merge	560
Apply Texture Analysis	564
Adjust Brightness	567
Adjust Slant Range	568
<b>Section V</b>	
<b>IMAGINE Vector™</b>	<b>571</b>
<b>CHAPTER 20</b>	
<b>IMAGINE Vector™</b>	<b>573</b>
Introduction	573
Copy Vector Data	574
Manipulate Info Files	576
Change Vector Symbology	583
Add Pattern Polygon Fill	586
Build Topology	589
Clean Vector Layer	590
<b>Section VI</b>	
<b>Appendix</b>	<b>593</b>
<b>APPENDIX A</b>	

# Table of Contents

<b>Additional Information</b> .....	<b>595</b>
<b>Classification</b> .....	<b>595</b>
Flow Chart .....	595
Advanced Classification .....	596
Signature Editor .....	596
<b>Fourier Transform Editor</b> .....	<b>597</b>
Fourier Editor Menu Bar .....	597
Fourier Editor Tool Bar .....	597
<b>Image Catalog</b> .....	<b>598</b>
Image Catalog Menu Bar .....	599
Image Catalog Tool Bar .....	599
Image Catalog CellArray .....	600
Adding Custom Maps .....	601
<b>Image Interpreter</b> .....	<b>606</b>
Image Interpreter Functions .....	606
<b>Import/Export</b> .....	<b>611</b>
Data View Menu Bar .....	611
Data View Tool Bar .....	611
ImageInfo Menu Bar .....	612
ImageInfo Tool Bar .....	612
<b>Map Composer</b> .....	<b>613</b>
Map Composer Menu Bar .....	616
Map Composer Tool Bar .....	617
Annotation Tool Palette .....	618
Ungroup Elements in Map Composer .....	620
<b>Mosaic</b> .....	<b>620</b>
Mosaic Tool Menu Bar .....	621
Mosaic Tool Tool Bar .....	621
<b>Rectification</b> .....	<b>623</b>
Input and Reference Images .....	624
GCP Tool Menu Bar .....	625
GCP Tool Bar .....	625
Record Ground Control Points .....	626
<b>Spatial Modeler</b> .....	<b>626</b>
About Model Maker .....	626
Creating Graphical Models .....	628
Defining Model Files and Parameters .....	628
Solving Problems .....	629
Determine Input Data .....	630
Determine Functions .....	630
Model Maker Viewer and Tool Palette .....	631
Model Maker Viewer Tool Bar .....	632
Model Maker Tool Palette .....	633
<b>Table Tool</b> .....	<b>635</b>
Table Tool Menu Bar .....	635
Table Tool Tool Bar .....	636
<b>Terrain Surface Editor</b> .....	<b>637</b>
3D Surfacing Dialog Menu Bar .....	637

# Table of Contents

3D Surfacing Dialog Tool Bar .....	637
<b>Vector</b> .....	<b>638</b>
Vector Tools .....	638
<b>Viewer</b> .....	<b>639</b>
About the Viewer .....	639
Viewer Menu Bar .....	640
Viewer Tool Bar .....	642
Duplicated Functionality .....	643
Keyboard Shortcuts .....	643
Histogram Edit Tools .....	644
Histogram Numbers .....	645
Manipulating Lookup Table Breakpoints .....	645
Image Drape Menu Bar .....	645
Image Drape Tool Bar .....	646
<b>Index</b> .....	<b>647</b>

# Table of Contents

# List of Tables

Table 1: ERDAS IMAGINE Documentation Functions . . . . .	.xix
Table 2: Session Menu Options . . . . .	xxii
Table 3: Main Menu Options . . . . .	xxiv
Table 4: Tools Menu Options . . . . .	xxv
Table 5: Utility Menu Options . . . . .	xxvi
Table 6: Help Menu Options . . . . .	xxvii
Table 2-1: Image Catalog Preferences . . . . .	61
Table 12-1: Film X and Film Y Coordinates . . . . .	274
Table 16-1: Class Values for n3_landcover_RC . . . . .	350
Table 16-2: Conditional Statement Class Values . . . . .	352
Table 16-3: Training Samples of Chaparral and Riparian Land Cover . . . . .	379
Table 16-4: Complete Criteria Table . . . . .	382
Table 19-1: Coefficient of Variation Values for Look-averaged Radar Scenes . . . . .	549
Table 19-2: Speckle Suppression Parameters . . . . .	551
Table 19-3: Filtering Sequence . . . . .	552
Table A-1 Signature Editor . . . . .	596
Table A-2 Fourier Editor Menu Bar . . . . .	597
Table A-3 Fourier Editor Tool Bar . . . . .	597
Table A-4 Image Catalog Menu Bar . . . . .	599
Table A-5 Image Catalog Tool Bar . . . . .	599
Table A-6 Image Catalog Data Characteristics . . . . .	600
Table A-7 Image Interpreter Functions . . . . .	606
Table A-8 Data View Menu Bar . . . . .	611
Table A-9 Data View Tool Bar . . . . .	611
Table A-10 ImageInfo Menu Bar . . . . .	612
Table A-11 ImageInfo Tool Bar . . . . .	612
Table A-12 Map Composer Menu Bar . . . . .	616
Table A-13 Map Composer Tool Bar . . . . .	617
Table A-14 Annotation Tool Palette . . . . .	618
Table A-15 Mosaic Tool Menu Bar . . . . .	621
Table A-16 Mosaic Tool Tool Bar . . . . .	621
Table A-17 GCP Tool Menu Bar . . . . .	625
Table A-18 GCP Tool Bar . . . . .	625
Table A-19 Model Maker Viewer Menu Bar . . . . .	632
Table A-20 Model Maker Viewer Tool Bar . . . . .	632
Table A-21 Model Maker Tool Palette . . . . .	633
Table A-22 Table Tool Menu Bar . . . . .	635
Table A-23 Table Tool Tool Bar . . . . .	636
Table A-24 3D Surfacing Dialog Menu Bar . . . . .	637
Table A-25 3D Surfacing Dialog Tool Bar . . . . .	637
Table A-26 Vector Tools . . . . .	638
Table A-27 Viewer Menu Bar . . . . .	640
Table A-28 Viewer Menu Bar, Continued . . . . .	641
Table A-29 Viewer Tool Bar . . . . .	642
Table A-30 Histogram Edit Tools . . . . .	644
Table A-31 Image Drape Menu Bar . . . . .	645
Table A-32 Image Drape Tool Bar . . . . .	646

# List of Tables





# Preface

---

## About This Manual

The *ERDAS IMAGINE Tour Guides*<sup>™</sup> manual is a compilation of tutorials designed to help you learn how to use ERDAS IMAGINE<sup>®</sup> software. This is a comprehensive manual, representing ERDAS IMAGINE and its add-on modules. Each guide takes you step-by-step through an entire process. The tour guides are not intended to tell you everything there is to know about any one topic, but to show you how to use some of the basic tools you need to get started.

This manual serves as a handy reference that you can refer to while using ERDAS IMAGINE for your own projects. Included is a comprehensive index, so that you can reference particular information later.

There are several sections to this manual. These sections are based upon the way in which ERDAS IMAGINE is packaged. The following sections are composed of the tour guides you go through in a step by step fashion to learn detailed information about the various ERDAS IMAGINE functions.

- Section I—IMAGINE Essentials<sup>™</sup>
- Section II—IMAGINE Advantage<sup>™</sup>
- Section III—IMAGINE Professional<sup>™</sup>
- Section IV—IMAGINE Radar Interpreter<sup>™</sup>
- Section V—IMAGINE Vector<sup>™</sup>

Section VI, Appendices, contains further information about interface buttons and menus.

---

## Example Data

Data sets are provided with the software so that your results match those in the tour guides. The data used in the tour guides are in the <IMAGINE\_HOME>/examples directory. <IMAGINE\_HOME> is the variable name of the directory where ERDAS IMAGINE resides. When accessing data files, you must replace <IMAGINE\_HOME> with the name of the directory where ERDAS IMAGINE is loaded on your system.

---

## Time Required

Each individual tour guide takes a different amount of time to complete, depending upon the options you choose and the length of the tour guide. The approximate completion time is stated in the introduction to each tour guide.

---

## Documentation

The *ERDAS IMAGINE Tour Guides* manual is part of a whole suite of printed and on-line documentation that you receive with ERDAS IMAGINE software.

### Printed Documentation

Following is a list of printed documentation that is available with ERDAS IMAGINE software. These may have been delivered in printed form or as digital .pdf files. The pdf files may be found in the <IMAGINE\_HOME>/help/hardcopy folder:

- ERDAS Field Guide<sup>™</sup> (also as FieldGuide.pdf)

## Preface

- *ERDAS IMAGINE Configuration Guide* (ConfigGuide.pdf)
- *ERDAS IMAGINE Tour Guides*™(TourGuide.pdf)
- ERDAS Macro Language Reference Manual (only as EML.pdf)
- ERDAS Spatial Modeler Language Reference Manual (only as SML.pdf)
- ERDAS IMAGINE Read Me First document
- ERDAS IMAGINE V8.5 Release Notes
- FLEXIm End Users Guide (only as enduser.pdf)
- What's New in ERDAS IMAGINE V8.5 (only as Whats\_New\_in\_IMAGINE\_85.pdf)

### On-Line Documentation

Following is a list of on-line manuals that can be found in the On-Line Help in ERDAS IMAGINE software. This list may change depending on your software package and add-on modules you have purchased:

- Introduction to ERDAS IMAGINE On-Line Help
- Annotation On-Line Manual
- AOI On-Line Manual
- Classification On-Line Manual
- Expert Classifier On-Line Manual
- Stereo Analyst On-Line Manual
- HyperSpectral On-Line Manual
- IMAGINE Command and Function Syntax On-Line Manual
- IMAGINE Interface On-Line Manual
- Image Catalog On-Line Manual
- Image Interpreter On-Line Manual
- Import/Export On-Line Manual
- Map Composer On-Line Manual
- OrthoBASE On-Line Manual
- Radar Mapping Suite On-Line Manual
- IFSAR DEM on-Line Manual
- StereoSAR DEM On-Line Manual



- OrthoRadar On-Line Manual
- Generic SAR Node On-Line Manual
- Rectification On-Line Manual
- Session On-Line Manual
- Preferences On-Line Manual
- Spatial Modeler On-Line Manual
- Tools and Utilities On-Line Manual
- Vector On-Line Manual
- Viewer On-Line Manual
- Viewer Raster Tools On-Line Manual
- Virtuality On-Line Manual
- Graphical Models Reference Guide
- DLL Reference Guide
- Imagizer On-Line Manual
- Appendices

## Documentation Functions

The following table depicts the different types of information you can extract from ERDAS IMAGINE documentation.

**TABLE 1: ERDAS IMAGINE Documentation Functions**

If you want to...	Read...
Install ERDAS IMAGINE	<i>ERDAS IMAGINE Release Notes</i> , then <i>ERDAS IMAGINE Configuration Guide</i>
Set up hardware for use with ERDAS IMAGINE	<i>ERDAS IMAGINE Configuration Guide</i>
Learn about new features in the latest release	<i>What's New in IMAGINE 8.5 (PDF)</i>
Learn to use ERDAS IMAGINE	<i>ERDAS IMAGINE Tour Guides</i>
Learn about GIS and image processing theory	<i>ERDAS Field Guide</i>
See what a particular dialog does	<i>On-Line Help</i>
Get quick information for a button or function	<i>On-Line Help</i> or <i>Status Bar Help</i>
Learn how to most effectively use the On-Line Help system	<i>Introduction to ERDAS IMAGINE On-Line Help</i>
Learn more about the Image Interpreter functions	<i>ERDAS IMAGINE Tour Guides</i>

# Preface

**TABLE 1:** ERDAS IMAGINE Documentation Functions

If you want to...	Read...
Use the Spatial Modeler Language to write models	<i>ERDAS Spatial Modeler Language Reference Manual</i>
Customize the ERDAS IMAGINE graphical user interface (GUI)	<i>ERDAS Macro Language Reference Manual</i>
Write custom application programs within ERDAS IMAGINE	<i>ERDAS Developers' Toolkit On-Line Manual</i>

## Conventions Used in This Book

In ERDAS IMAGINE, the names of menus, menu options, buttons, and other components of the interface are shown in bold type. For example:

“In the Select Layer To Add dialog, select the **Fit to Frame** option.”

When asked to use the mouse, you are directed to click, Shift-click, middle-click, right-click, hold, drag, etc.

- click—designates clicking with the left mouse button.
- Shift-click—designates holding the Shift key down on your keyboard and simultaneously clicking with the left mouse button.
- middle-click—designates clicking with the middle mouse button.
- right-click—designates clicking with the right mouse button.
- hold—designates holding down the left (or right, as noted) mouse button.
- drag—designates dragging the mouse while holding down the left mouse button.



The following paragraphs are used throughout the ERDAS IMAGINE documentation:



*These paragraphs contain strong warnings or important tips.*



*These paragraphs direct you to the ERDAS IMAGINE software function that accomplishes the described task.*



*These paragraphs lead you to other areas of this book or other ERDAS® manuals for additional information.*

**NOTE:** Notes give additional instruction.

### Shaded Boxes

Shaded boxes contain supplemental information that is not required to execute the steps of a tour guide, but is noteworthy. Generally, this is technical information.

## Getting Started

To start ERDAS IMAGINE, type the following in a UNIX command window: **imagine**, or select **ERDAS IMAGINE 8.5** from the **Start** menu.

ERDAS IMAGINE begins running; the icon panel automatically opens.

### ERDAS IMAGINE Icon Panel

The ERDAS IMAGINE icon panel contains icons and menus for accessing ERDAS IMAGINE functions. You have the option (through the **Session | Preferences** menu) to display the icon panel horizontally across the top of the screen or vertically down the left side of the screen. The default is a horizontal display.

The icon panel that displays on your screen looks similar to the following:

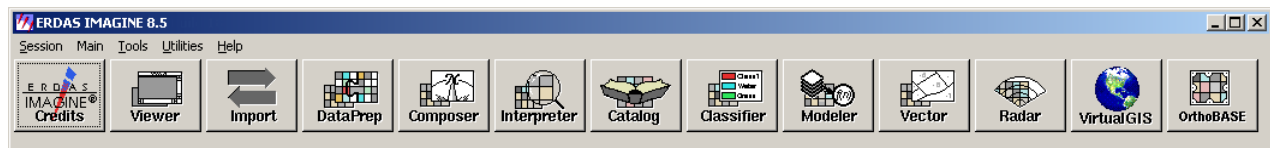

The various icons that are present on your icon panel depend on the components and add-on modules you have purchased with your system.

### ERDAS IMAGINE Menu Bar

The menus on the ERDAS IMAGINE menu bar are: **Session**, **Main**, **Tools**, **Utilities**, and **Help**. These menus are described in this section.

**NOTE:** Any items which are unavailable in these menus are shaded and inactive.

# Preface

## Session Menu

1. Click on the word **Session** in the upper left corner of the ERDAS IMAGINE menu bar. The **Session** menu opens:

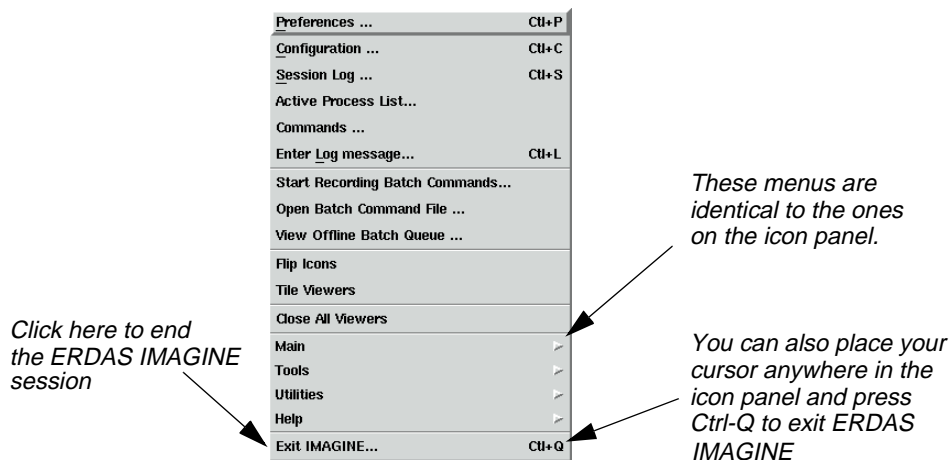

The following table contains the **Session** menu selections and their functionalities:

**TABLE 2: Session Menu Options**

Selection	Functionality
Preferences	Set individual or global default options for many ERDAS IMAGINE functions (Viewer, Map Composer, Spatial Modeler, etc.).
Configuration	Configure peripheral devices for ERDAS IMAGINE.
Session Log	View a real-time record of ERDAS IMAGINE messages and commands, and to issue commands.
Active Process List	View and cancel currently active processes running in ERDAS IMAGINE.
Commands	Open a command shell, in which you can enter commands to activate or cancel processes.
Enter Log Message	Insert text into the Session Log.
Start Recording Batch Commands	Open the Batch Wizard. Collect commands as they are generated by clicking the <b>Batch</b> button that is available on many ERDAS IMAGINE dialogs.
Open Batch Command File	Open a Batch Command File (*.bcf) you have saved previously.

TABLE 2: Session Menu Options (Continued)

Selection	Functionality
<b>View Offline Batch Queue</b>	Open the Scheduled Batch Job list dialog, which gives information about pending batch jobs.
<b>Flip Icons</b>	Specify horizontal or vertical icon panel display.
<b>Tile Viewers</b>	Rearrange two or more Viewers on the screen so that they do not overlap.
<b>Close All Viewers</b>	Close all Viewers that are currently open.
<b>Main</b>	Access a menu of tools that corresponds to the icons along the ERDAS IMAGINE icon bar.
<b>Tools</b>	Access a menu of tools that allow you to view and edit various text and image files.
<b>Utilities</b>	Access a menu of utility items that allow you to perform general tasks in ERDAS IMAGINE.
<b>Help</b>	Access the ERDAS IMAGINE On-Line Help.
<b>Exit IMAGINE</b>	Exit the ERDAS IMAGINE session (keyboard shortcut: Ctrl-Q).

### Main Menu

- Click on the word **Main** in the ERDAS IMAGINE menu bar. The **Main** menu opens



The following table contains the **Main** menu selections and their functionalities:

**TABLE 3: Main Menu Options**

Selection	Functionality
IMAGINE Credits	Open ERDAS IMAGINE credits.
Start IMAGINE Viewer	Start an empty Viewer.
Import/Export	Open the Import/Export dialog.
Data Preparation	Open the <b>Data Preparation</b> menu.
Map Composer	Open the <b>Map Composer</b> menu.
Image Interpreter	Open the <b>Image Interpreter</b> menu.
Image Catalog	Open the Image Catalog dialog.
Image Classification	Open the <b>Classification</b> menu.
Spatial Modeler	Open the <b>Spatial Modeler</b> menu.
Vector	Open the <b>Vector Utilities</b> menu.
Radar	Open the <b>Radar</b> menu.
VirtualGIS	Open the <b>VirtualGIS</b> menu.
OrthoBASE	Open the OrthoBASE Startup dialog.

### Tools Menu

3. Click on the word **Tools** in the ERDAS IMAGINE menu bar. The **Tools** menu opens:





The following table contains the **Tools** menu selections and their functionalities:

**TABLE 4: Tools Menu Options**

Selection	Functionality
<b>Edit Text Files</b>	Create and edit ASCII text files.
<b>Edit Raster Attributes</b>	Edit raster attribute data.
<b>View Binary Data</b>	View the contents of binary files in a number of different ways.
<b>View IMAGINE HFA File Structure</b>	View the contents of the ERDAS IMAGINE hierarchical files.
<b>Annotation Information</b>	View information for annotation files, including number of elements and projection information.
<b>Image Information</b>	Obtain full image information for a selected ERDAS IMAGINE raster image.
<b>Vector Information</b>	Obtain full image information for a selected ERDAS IMAGINE vector coverage.
<b>Image Command Tool</b>	Open the Image Command dialog.
<b>Coordinate Calculator</b>	Transform coordinates from one spheroid or datum to another.
<b>Create/Display Movie Sequences</b>	View a series of images in rapid succession.
<b>Create/Display Viewer Sequences</b>	View a series of images saved from the Viewer.
<b>Image Drape</b>	Create a perspective view by draping imagery over a terrain DEM.
<b>Manage PostScript and TrueType Fonts</b>	Add new fonts to ERDAS IMAGINE annotation via FontTastic Font Manager.
<b>View EML ScriptFiles</b>	Open the EML View dialog, which enables you to view, edit, and print ERDAS IMAGINE dialogs.

#### Utilities Menu

4. Click on **Utilities** on the ERDAS IMAGINE menu bar. The **Utilities** menu opens:

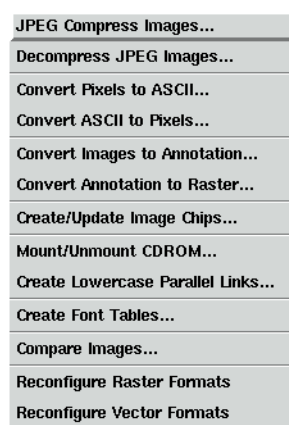

The following table contains the **Utilities** menu selections and their functionalities:

**TABLE 5: Utility Menu Options**

Selection	Functionality
<b>JPEG Compress Images</b>	Compress raster images using the JPEG compression technique and save them in an ERDAS IMAGINE format.
<b>Decompress JPEG Images</b>	Decompress images compressed using the JPEG Compress Images utility.
<b>Convert Pixels to ASCII</b>	Output raster data file values to an ASCII file.
<b>Convert ASCII to Pixels</b>	Create an image from an ASCII file.
<b>Convert Images to Annotation</b>	Convert a raster image to polygons saved as ERDAS IMAGINE annotation (.ovr).
<b>Convert Annotation to Raster</b>	Convert an annotation file containing vector graphics to a raster image file.
<b>Create/Update Image Chips</b>	Provide a direct means of creating chips for one or more images.
<b>Mount/Unmount CD-ROM</b>	Mount and unmount a CD-ROM drive.
<b>Create Lowercase Parallel Links</b>	Make a set of links to items on CD for systems that convert CD paths to uppercase.
<b>Font to Symbol</b>	Create a symbol library to use as annotation characters from an existing font.
<b>Create Font Tables</b>	Create a map of characters in a particular font.
<b>Compare Images</b>	Open Image Compare dialog. Compare layers, raster, map info, etc.
<b>Reconfigure Raster Formats</b>	Start a DLL to reconfigure raster formats.

TABLE 5: Utility Menu Options (Continued)

Selection	Functionality
Reconfigure Vector Formats	Start a DLL to reconfigure vector formats.
Reconfigure Resample Methods	Start a DLL to reconfigure resampling methods.
Reconfigure Geometric Models	Start a DLL to reconfigure the geometris models.

### Help Menu

5. Select **Help** from the ERDAS IMAGINE menu bar. The **Help** menu opens.

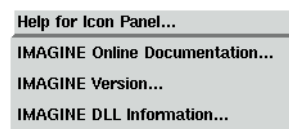

*NOTE: The **Help** menu is also available from the **Session** menu.*

The following table contains the **Help** menu selections and their functionalities:

TABLE 6: Help Menu Options

Selection	Functionality
Help for Icon Panel	View the On-Line Help for the ERDAS IMAGINE icon panel.
IMAGINE Online Documentation	Access the root of the On-Line Help tree.
IMAGINE Version	View which version of ERDAS IMAGINE you are running.
IMAGINE DLL Information	Display and edit DLL class information and DLL instance information.

6. From the **Help** menu, select **Help for Icon Panel**. The following Help page displays in your default internet browser:

# Preface

**Back button**  
Click to return to the last topic viewed

**Show/Hide button**  
Displays or hides the navigation pane

**Browse buttons**  
Click to move to the next or previous topic in the browse sequence

**Slider bar**  
Use the slider bar to scroll through long help topics

**Location bar**  
Displays the location of the current help file

**Hyperlinks**  
Click on the blue\* underlined words to link to other help topics

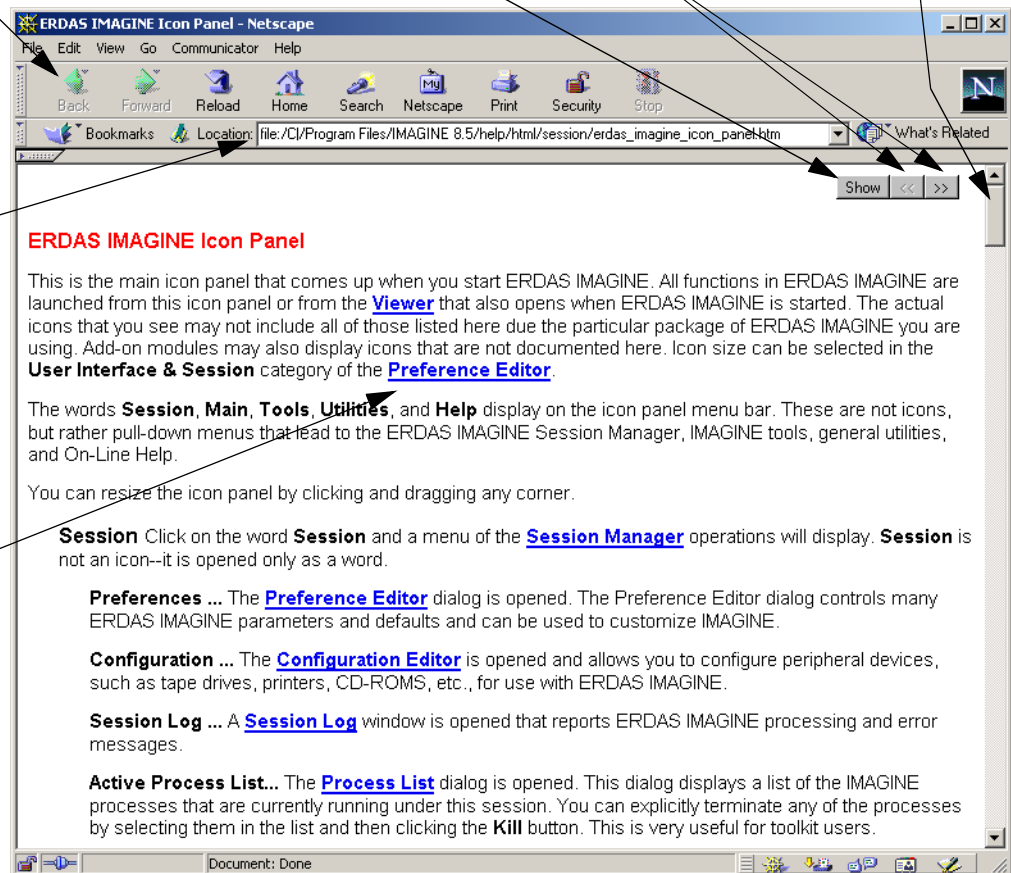

\* blue is the default link color; your system may be different

The ERDAS IMAGINE On-Line Help (OLH) system is a collection of on-line manuals that functions just like an internet website. The OLH system includes help for all of the dialogs in ERDAS IMAGINE, as well as in-depth Help files that provide more details about a process. Each manual covers a specific topic. These manuals can be printed for convenience. The individual html files may also be bookmarked for quick reference.

7. Click the **Show** button at the upper right corner of the help topic. The Navigation Pane displays in the left portion of your browser.



**Contents**  
Click on this tab to view the Table of Contents

**Index**  
Click on this tab to look up help topics by keyword

**Search**  
Click on this tab to perform a Full Text Search for a word or phrase

**Show/Hide button**  
Displays or hides the navigation pane



Use the slider bars to scroll through the navigation pane

Click the + to open a book and browse its topics

Click the - to close a book and hide its topics

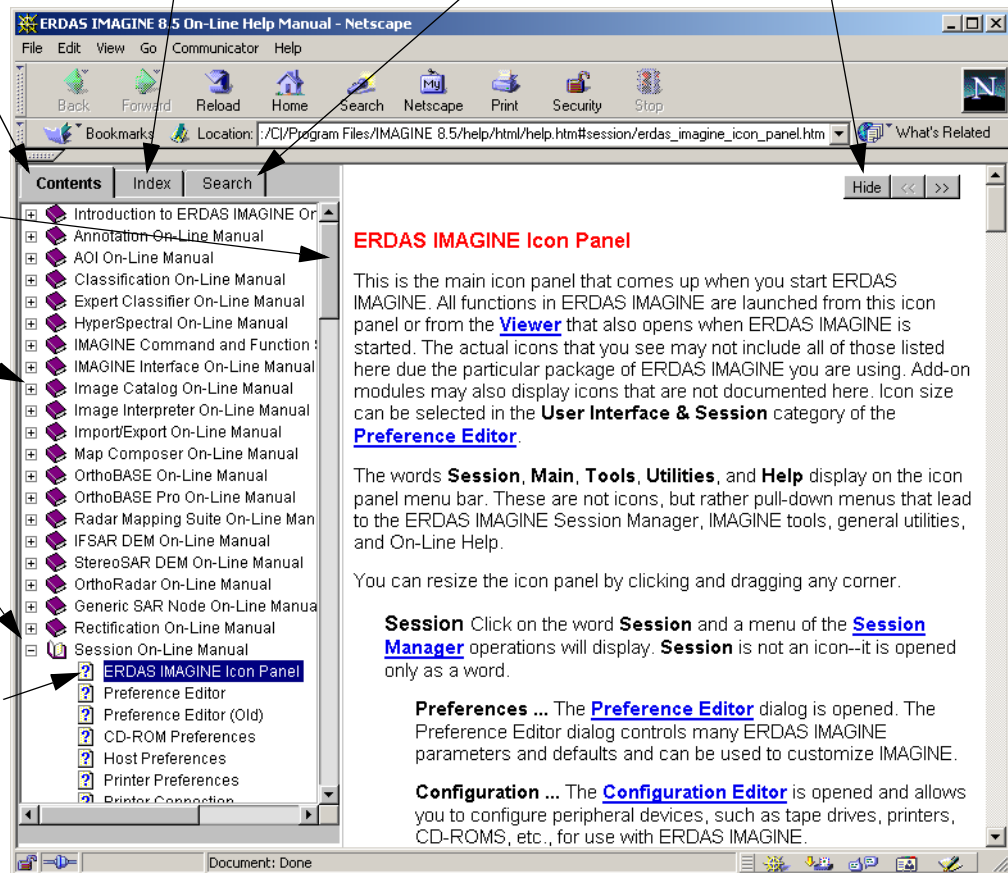
Click once to select a topic. Double-click to open a topic. The currently displayed topic is highlighted in the Table of Contents.



8. Click on the + beside the **Viewer On-Line Manual** in the **Contents** tab to view all of the topics in the **Viewer** manual.
9. Double-click on the **Viewer** topic.
10. The first page of the Viewer Manual is displayed. Use the  and  browse buttons to jump from topic to topic and the scroll bars to page through a topic. Click on any hyperlinked text to jump to that topic. Click the **Back** button to return to the point from which you jumped.
11. Use the **Contents**, **Index**, and **Search** tabs when looking for a specific title, subject, or word or phrase.
12. Select **File | Exit** from the On-Line Help file menu bar when you are finished reading On-Line Help. The Help window is closed.

## Preface

### Dialogs

A dialog is a window in which you enter file names, set parameters, and execute processes. In most dialogs, there is very little typing required—simply use the mouse to click on the options you want to use.

Most of the dialogs used throughout the tour guides are reproduced from the software, with arrows showing you where to click. These instructions are for reference only. Follow the numbered steps to actually select dialog options.

For On-Line Help with a particular dialog, click the **Help** button in that dialog.

All of the dialogs that accompany the raster and vector editing tools, as well as the Select Layer To Add dialog, contain a Preview window, which enables you to view the changes you make to the Viewer image before you click **Apply**.

Most of the functions in ERDAS IMAGINE are accessible through dialogs similar to the one below:

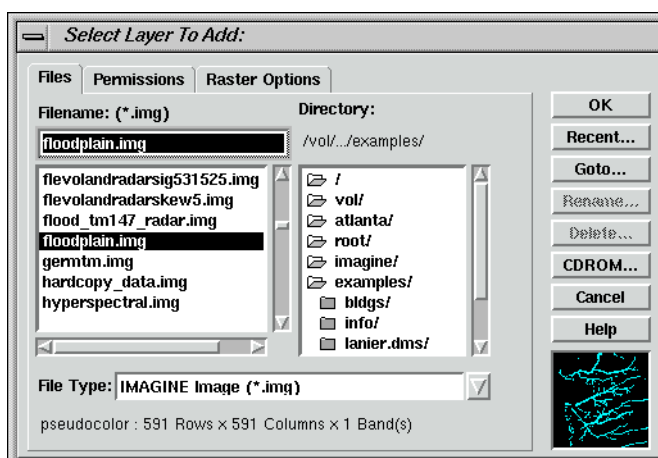

---

### More Information/Help

As you go through the tour guides, or as you work with ERDAS IMAGINE on your own, there are several ways to obtain more information regarding dialogs, tools, or menus, as described below.

#### On-Line Help

There are two main ways you can access On-Line Help in ERDAS IMAGINE:

- select the **Help** option from a menu bar
- click the **Help** button on any dialog.

#### Status Bar Help

The status bar at the bottom of the Viewer displays a quick explanation for buttons when the mouse cursor is placed over the button. It is a good idea to keep an eye on this status bar, since helpful information displays here, even for other dialogs.

### Bubble Help

The Preference Editor enables you to turn on Bubble Help, so that the single-line Help displays directly below your cursor when your cursor rests on a button or frame part. This is helpful if the status bar is obscured by other windows.

# Preface





# *Section I*

# *IMAGINE Essentials™*

# Section I IMAGINE Essentials™



# CHAPTER 1

## Viewer

---

### Introduction

In this tour guide, you can learn how to:

- set Preferences
- display an image
- query for pixel information
- arrange layers
- adjust image contrast
- link Viewers
- use the Area of Interest (AOI) function
- use the **Raster** menu functions (Raster Attribute Editor, Measurement tools, etc.)



---

*Approximate completion time for this tour guide is 45 minutes.*

---

### Display Preferences

#### Prepare

ERDAS IMAGINE should be running and a Viewer should be open.

### Check Band-to-Color Gun Assignments

ERDAS IMAGINE allows you to set up default band-to-color gun assignments for Landsat MSS, Landsat TM, SPOT, and AVHRR data in the Preference Editor.

1. Click on the word **Session** in the upper left corner of the ERDAS IMAGINE menu bar.
2. From the **Session** menu, click on **Preferences**.

The Preference Editor opens.



# Viewer

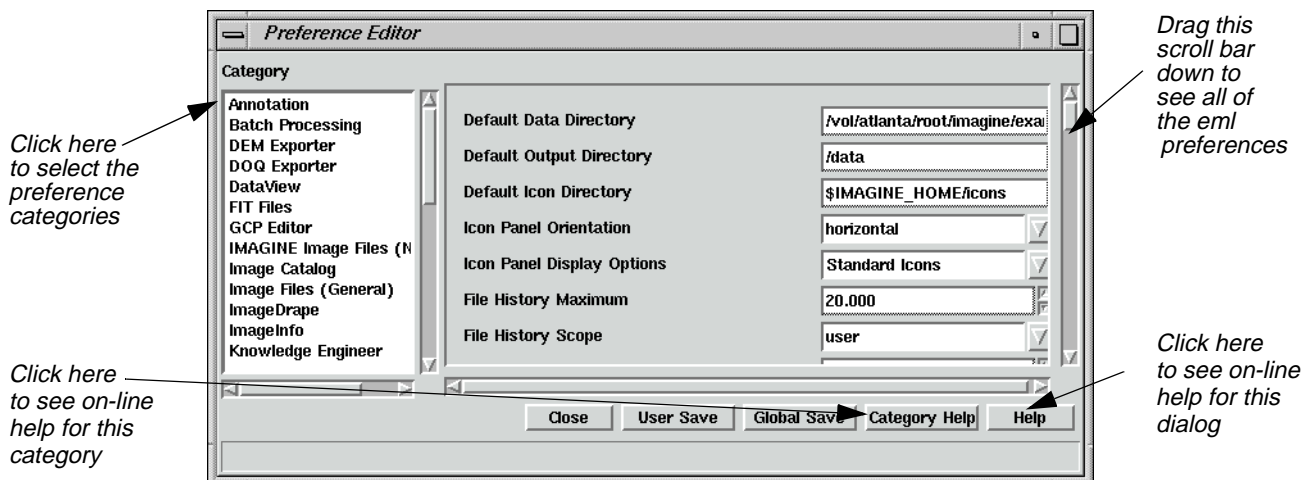

3. Drag the scroll bar on the right side of the dialog down to see all of the **User Interface & Session** preferences (**User Interface & Session** is the default under **Category**).

You may change these or any other preferences at any time by selecting the preference category (click on the list below **Category**) and then editing the text in the text entry fields.

4. Under the **User Interface & Session** category in the Preference Editor, locate the preferences for the **AVHRR Band Defaults**, **MSS Band Defaults**, **Spot Band Defaults**, and **TM Band Defaults**.

The number that is entered for these defaults shows the band that is used for the Red, Green, and Blue color guns in your display. You may change these defaults. These are the band assignments that display in the **Layers to Colors** section of the Select Layer To Add dialog when it opens. These assignments can also be changed in the Select Layer To Add dialog for specific files.

## Check Viewer Preferences

1. With the Preference Editor still open, click on the **Category** list and select **Viewer**.

The Viewer preferences display.

2. Drag the scroll bar on the right of the dialog down to see all of the **Viewer** preferences.

These preferences control the way the Viewer automatically displays and responds each time it is opened.

## Check Preference Editor Help

1. Click on **Help** in the lower right corner of the dialog.

The On-Line Help for the Preference Editor opens.

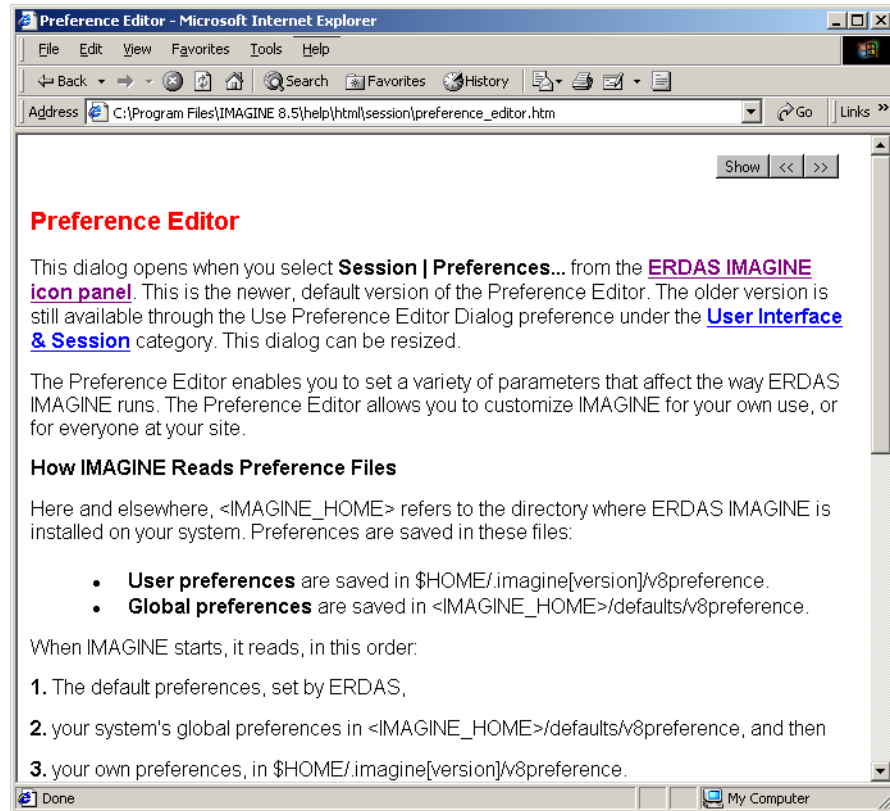

2. When you are through studying the Preference Editor help file, select **File | Exit** from the On-Line Help file menu bar.

The On-Line Help file closes.

### View Category Help

1. Click the **Category Help** button on the Preference Editor.

The On-Line Help for this category, **Viewer**, opens.

# Viewer

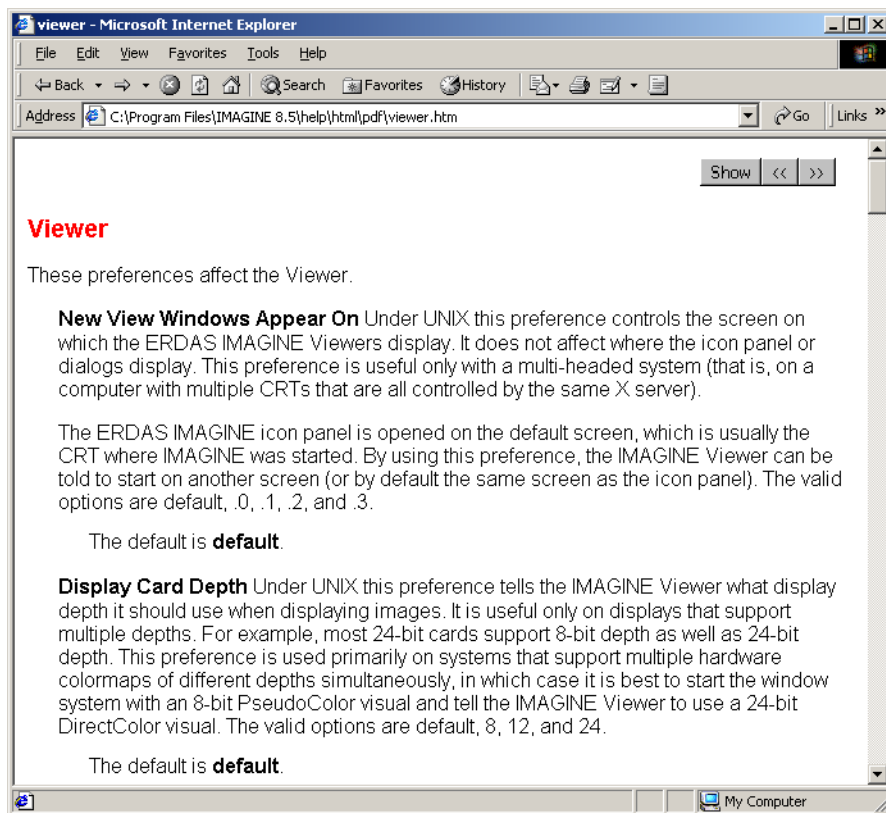

2. When you are through studying the Viewer preferences help file, select **File | Exit** from the On-line Help file menu bar.
3. Click the **Close** button on the Preference Editor.

*NOTE: If you have changed any preferences, you can save them at this time by clicking the **User Save** or **Global Save** buttons on the Preference Editor dialog.*

---

## Display an Image

Next, you display a Landsat Thematic Mapper (TM) image of Gainesville, Georgia in a Viewer.

### Prepare

Since the data files in the <IMAGINE\_HOME>/examples directory are read only, you may want to copy them to a new directory and change the file permissions. Remember, <IMAGINE\_HOME> is the variable name for the directory where ERDAS IMAGINE resides.

1. In the Viewer menu bar, select **File | Open | Raster Layer**.



*You can also open this dialog using either of these two methods:*

— use the keyboard shortcut, **Ctrl-r**



— click on this icon in the Viewer tool bar.



The Select Layer To Add dialog opens.

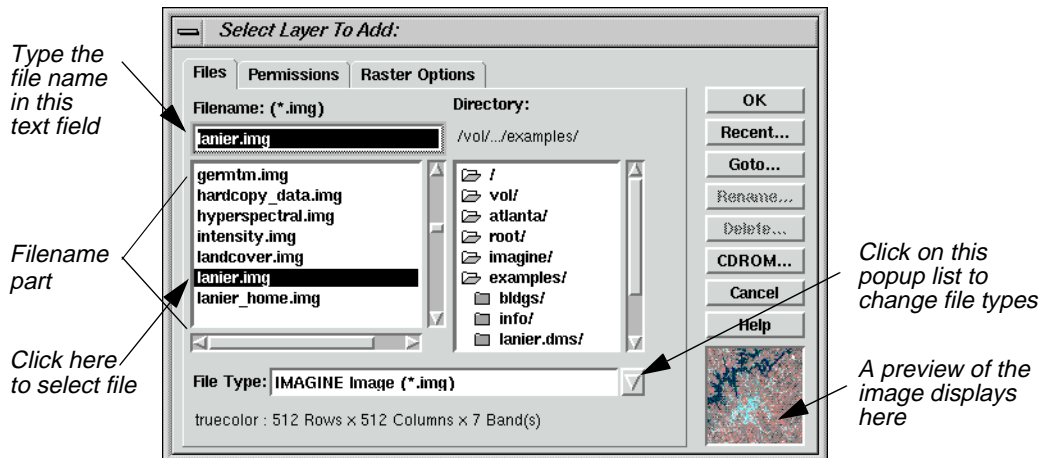

2. In the Select Layer To Add dialog, click on the **Recent** button.

A dialog with a listing of the most recent files you have opened displays. You can individually select these files and then click **OK** to display them quickly in the Select Layer To Add dialog.

3. Click **Cancel** in the List of Recent Filenames dialog.

4. In the Select Layer To Add dialog, click on the **Goto** button.

A dialog with a listing of the most recent directories you have opened displays. You can individually select these directories, or enter the name of a new directory, and then click **OK** to display that directory quickly in the Select Layer To Add dialog.

5. Click **Cancel** in the Select a Directory dialog.

*NOTE: The **Recent** and **Goto** buttons in the Select Layer To Add dialog are helpful for quickly locating and displaying a file or directory you work with often.*

## Filename Part

The framepart under **Filename** is called a filename part. A filename part is a tool used to select specific files for use in an ERDAS IMAGINE function. A filename part consists of:

- a text field—for entering the file name by typing it in, or clicking on, the file from the scroll list.
- a scrolling list—shows the name of all files with the default extension in the selected directory. Files can be selected by clicking on the name in the list.

## Viewer

6. In the filename part of the Select Layer To Add dialog, click on the file **lanier.img**.

This is a Landsat TM image of the Gainesville, Georgia area, including Lake Lanier. Information about this file is reported in the bottom, left corner of the Select Layer To Add dialog. This true color image has seven bands, 512 columns, and 512 rows.

7. Click on the **Raster Options** tab at the top of the Select Layer To Add dialog.

The Raster Options display.

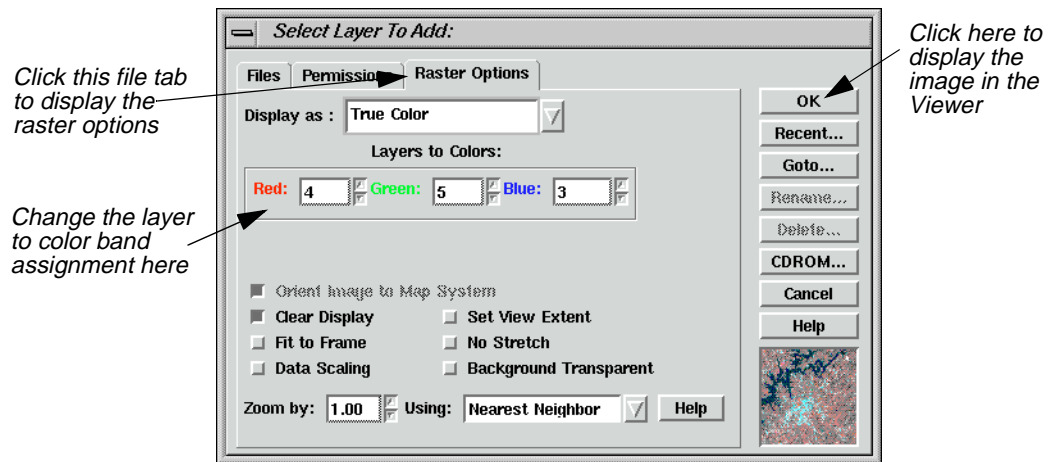

8. Under **Layers to Colors**, display band **4** in the **Red** color gun, band **5** in the **Green** color gun, and band **3** in the **Blue** color gun.

## Display Options

1. Note the display options in the Select Layer To Add dialog.



## Display Options Defaults

The default settings of the Raster Options tab are briefly described below:

- **Orient Image to Map System**—This checkbox is enabled if calibration is saved to the image file. If there is no calibration, this option is disabled. When enabled, the image is displayed using calibration. Otherwise, the calibration is ignored.
- **Clear Display**—When this checkbox is enabled, and a new image is loaded, the image currently displayed in the Viewer is removed. Disable this checkbox to overlay images.
- **Fit to Frame**—If this checkbox is enabled, the image is magnified or reduced to fit the Viewer window at its current size.
- **Data Scaling**—The Viewer performs a two standard deviation stretch by default. Click this checkbox to select an alternate data range to stretch.

If you want to save the contrast stretched values with the image, you can use the **Radiometric Enhance | LUT Stretch** option of Image Interpreter.

- **Zoom by**—If **Fit to Frame** is disabled, then you can enter the zoom ratio for the data in this data field.
- **Set View Extent**—Allows you to specify the upper left and lower right coordinates of the portion of the image to display.

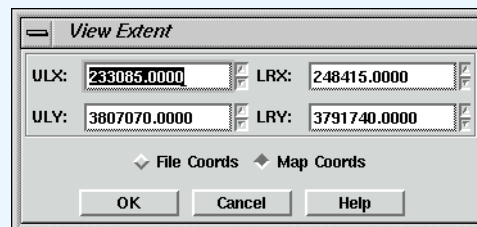

The coordinates in this dialog set the area of the image to display in the Viewer. This is useful if you have an image that is larger than the Viewer window, or if you want only a specific portion of a large image to display in the Viewer. You can also select **View | Extent** from the Viewer menu bar.

- **No Stretch**—Click to display data without applying the normal two standard deviation stretch.
- **Background Transparent**—Click to make the background of gray scale, pseudocolor, and true color areas transparent—the layer underneath shows through. Background areas are automatically transparent in thematic layers.
- **Using**—Resampling is appropriate if the image is magnified (a magnification factor greater than one). Use one of the following resampling methods: Nearest Neighbor, Bilinear Interpolation, Cubic Convolution.



*These methods of resampling are discussed in "CHAPTER 9: Rectification" of the ERDAS Field Guide.*

## Viewer

2. Click **OK** in the Select Layer To Add dialog to display the file.

The file **lanier.img** is displayed in the Viewer. The name of the file and the layers selected are written in the Viewer title bar.

*Click here to minimize the window*

*The title bar shows the Viewer number and name of image displayed*

*In the title bar, hold and drag to move the Viewer*

*Drag on any of the corners to resize the Viewer*

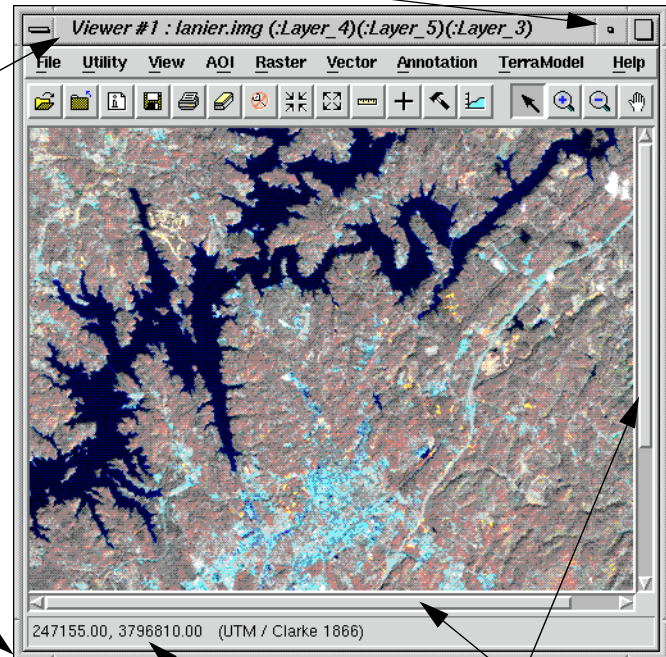

*Single-line help and coordinates display in this Status Bar*

*Use the scroll bars to roam in an image*

### Utility Menu Options

The **Utility** menu on the Viewer enables you to access four separate groups of functions:

- inquiry functions
- measurement tool
- layer viewing
- information

Each function group is separated by a line in the pulldown menu.

### Use Inquiry Functions

You can query a displayed image for information about each pixel using the inquiry functions.

#### Prepare

The file **lanier.img** must be displayed in a Viewer.

1. Select **Utility | Inquire Cursor** from the Viewer menu bar.

A white crosshair displays in the Viewer and the Inquire Cursor dialog opens.



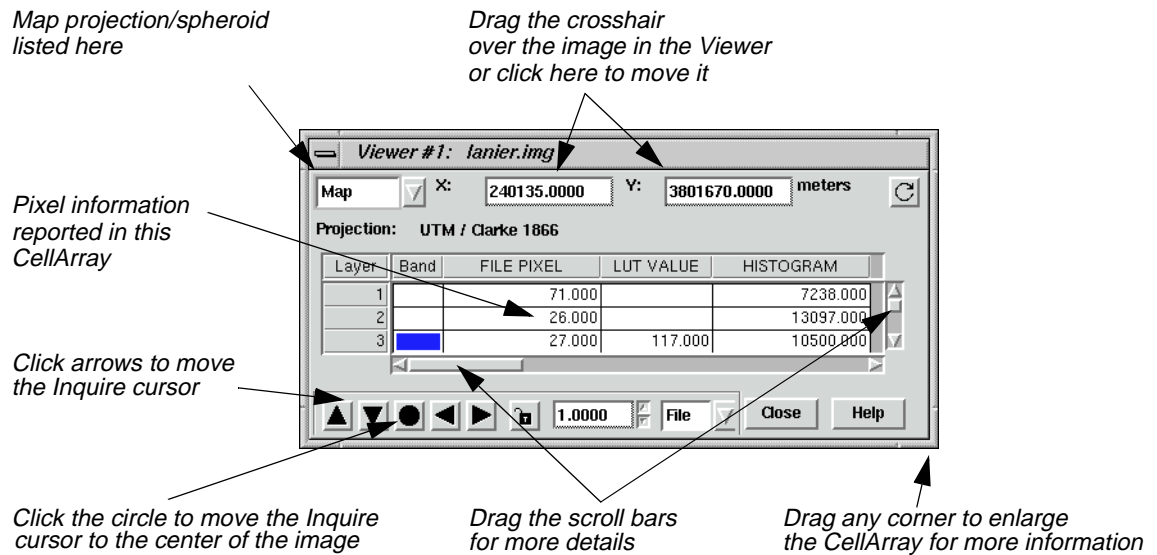

You can move the Inquire Cursor in the Viewer using any of these methods:

- drag the white crosshair over the image.
- enter new coordinates into the CellArray™ of the Inquire Cursor dialog. The Inquire Cursor moves when you move the mouse cursor back into the Viewer.
- click on the black arrows at the bottom of the Inquire Cursor dialog.

As the crosshair is moved, the information in the Inquire Cursor dialog automatically updates.

2. The CellArray in the Inquire Cursor dialog reports a variety of pixel information. Drag on the horizontal scroll bar (or enlarge the Inquire Cursor dialog by dragging any corner) to show all of the pixel information available in the CellArray.

## Change Inquire Cursor Style

You can change the color and shape of the Inquire Cursor to make it more visible in the Viewer.

1. To change the color of the Inquire Cursor, select **Utility | Inquire Color** from the Viewer menu bar.

The Inquire Color dialog opens.

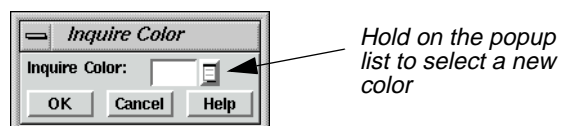

2. Select a new color for the Inquire Cursor by holding on the **Inquire Color** popup list and dragging to select the desired color.

## Viewer

3. Click **OK** in the Inquire Color dialog.

The Inquire Cursor changes colors.

4. To change the shape of the Inquire Cursor, select **Utility | Inquire Shape** from the Viewer menu bar.

The Inquire Shape dialog opens

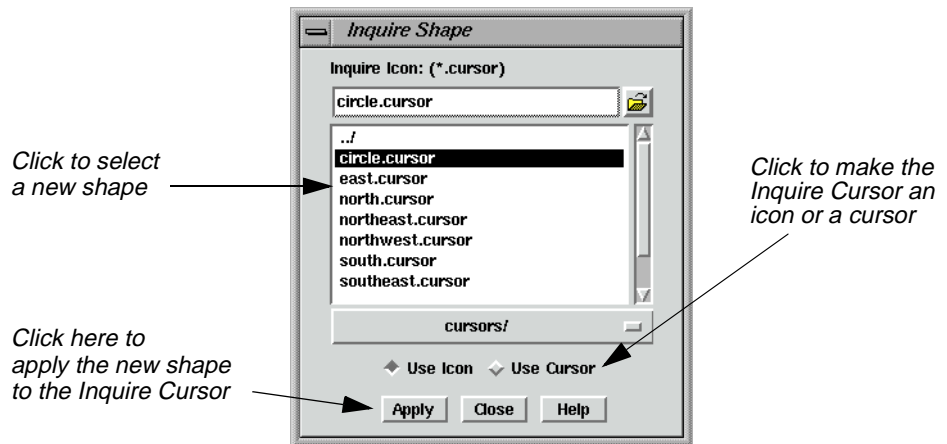

5. Click on **circle.cursor** in the scroll list that displays, then click **Apply**.

The Inquire Cursor becomes a circle.

6. In the Inquire Shape dialog, click on the **Use Cursor** button, then **Apply** to return the Inquire Cursor to the original crosshair shape.

7. Click **Close** in the Inquire Shape and the Inquire Cursor dialogs.

The Inquire Cursor is cleared from the Viewer.

## Take Measurements

The Measurement tool enables you to measure points, lines, polygons, rectangles and ellipses in the displayed layer. Both distance and area are reported in the units you select.

1. Click on the Measurement icon in the Viewer tool bar or select **Utility | Measure** from the Viewer menu bar.



The Measurement Tool viewer opens.

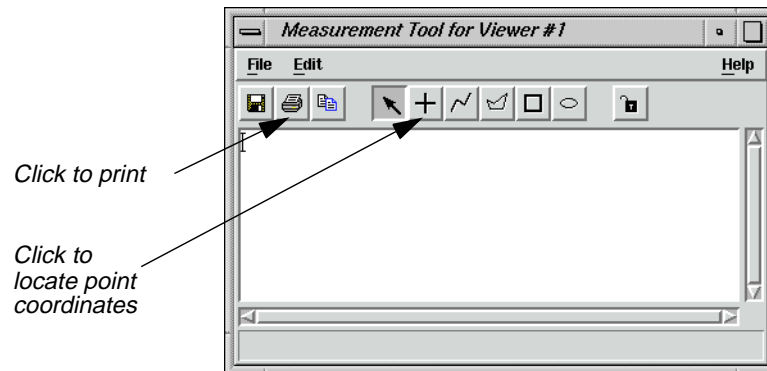

The Measurement Tool viewer has a menu bar and a tool bar like the Viewer.

2. Click on the Measure Positions icon in the Measurement tool bar.



This tool gives the individual point coordinates (x, y) in the image.



*The Measurement tools work similarly to the Annotation tools. For information about the Annotation Tool Palette, see "APPENDIX A: Additional Information" on page 618.*

3. Move the cursor into the Viewer and click anywhere.

In the Measurement Tool viewer, the location of the point displays in the type of units in which the file is saved.

4. Next, click on the Polyline icon in the Measurement Tool viewer tool bar.



5. Move the cursor into the Viewer and drag to measure a length between two points. You can then click to add a vertex to the length. Middle-click (or double-click, depending on how your Preferences are set) to end the measurement.

The length is displayed in the Measurement Tool viewer.



## Viewer

### The Measurement Tool

The Measurement Tool viewer acts as a text editor. The measurements are entered as text that can be edited, copied, or printed like any other text. You can print the measurement text in the dialog using any one of the following methods:

- Measurement Tool viewer menu bar—select **File | Print**.
- Keyboard shortcut—with the mouse cursor in the Measurement Tool viewer, press Ctrl-P.
- Measurement Tool viewer tool bar—click on this icon.



6. Select one of the above ways to print and a Print dialog opens, which allows you to enter the printer device name to be used.

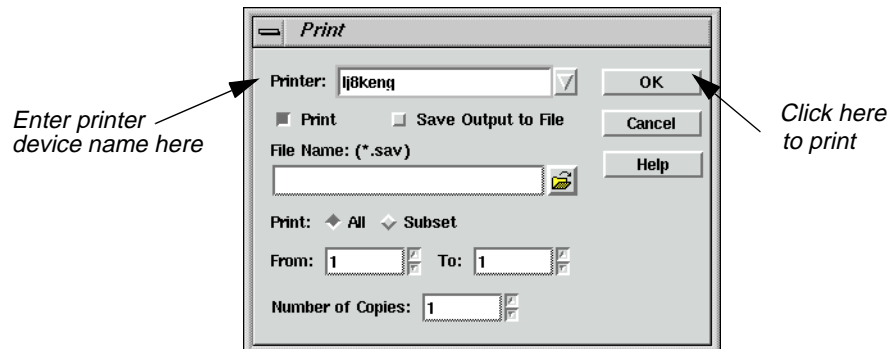

7. Enter the **Printer** name and click **OK** in the Print dialog. If you do not wish to print, click **Cancel**.
8. Experiment with the other measurement tools if you like, and when you are done, select **File | Close** from the Measurement Tool viewer menu bar (or press Ctrl-d with the cursor in the Measurement dialog) to close the Measurement Tool viewer.

You are asked if you want to save the measurements. Save them if you like.

---

## View Menu Options

### Arrange Layers

### Prepare

ERDAS IMAGINE should be running, and **lanier.img** should be displayed in a Viewer.



1. In the Viewer tool bar, click the Open icon to open another layer on top of **lanier.img**.



The Select Layer To Add dialog opens.

2. In the Select Layer To Add dialog under **Filename**, click on **Insoils.img**. This is a thematic soils file of the Gainesville, Georgia area.
3. Click on the **Raster Options** tab at the top of the Select Layer To Add dialog.
4. Check to be sure that the **Clear Display** checkbox is disabled (not selected), so that **lanier.img** is not cleared from the Viewer when **Insoils.img** is displayed.
5. Click **OK** in the Select Layer To Add dialog to display the file.

Now, both **lanier.img** and **Insoils.img** are displayed in the same Viewer, with **Insoils.img** on top.

6. To bring **lanier.img** to the top of the Viewer, select **View | Arrange Layers** from the Viewer menu bar.

The Arrange Layers dialog opens.

*Click and drag this box to the top to change the order of the displayed layers*

*Click here to redisplay layers in the new order*

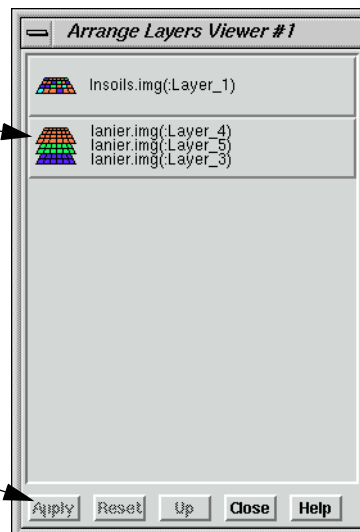

7. In the Arrange Layers dialog, drag the **lanier.img** box above the **Insoils.img** box, as illustrated above.

When you release the mouse button, the layers are rearranged in the Arrange Layers dialog so that the **lanier.img** box is first.

## Viewer

8. Click **Apply** in the Arrange Layers dialog to redisplay the layers in their new order in the Viewer.

The layers are now reversed.

9. Click **Close** in the Arrange Layers dialog.

## Zoom

In this section, you zoom in by a factor of 2 and create a magnifier window. Once the image is enlarged, you can roam through it.

### Prepare

**lanier.img** should be displayed on top of **Insoils.img** in a Viewer at a magnification of 1 (this is the case if you have been following through this tour guide from the beginning).

1. Select **View | Zoom | In by 2** from the Viewer menu bar.

The images are redisplayed at a magnification factor of 2.



---

*The Zoom options are also available from:*

— the **Quick View** menu (right-hold on the Viewer image) under

**Zoom | Zoom In by 2**

— the Viewer tool bar by clicking this icon.



2. Move the scroll bars on the bottom and side of the Viewer window to view other parts of the image.

To move by small increments, you can click the small triangles at either end of the scroll bars. To move by larger increments, drag the scroll bars.

You can also enlarge the Viewer window by dragging any corner.

3. Select **View | Create Magnifier** from the Viewer menu bar.

A white cursor box opens in the center of the image. This area is displayed in a small magnifier window that opens over the top corner of the Viewer.



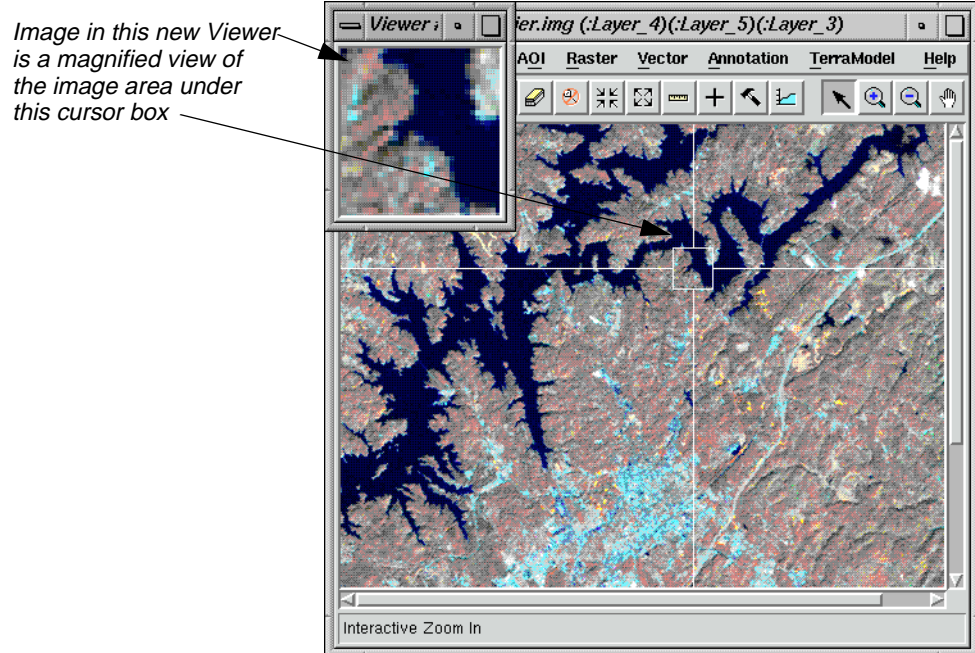

4. With your pointer inside the white cursor box, hold and drag the box around the image.

The data in the magnifier window change as the cursor box is moved over the image. This technique is called chip extraction, which is used in the Rectification tools to help you precisely identify ground control points (GCPs).

### Magnifying Areas

There are four ways to change the size of the area magnified:

- With the cursor on any corner (or side) of the cursor box, drag the box until it is the desired size.
- Place the cursor on the lower right corner of the magnifier window and drag the magnifier window until it is the desired size.
- Press the space bar to enter precise positioning coordinates in the inquire box dialog.
- Use the **Quick View** menu (from the right mouse button) or the **View** menu (from the Viewer menu bar) to zoom in either Viewer.

As you try these methods, you notice that each change in size is reflected in the other window. As the cursor box is adjusted, the magnification in the magnifier window is adjusted to accommodate the new area. Likewise, as the magnifier window is adjusted, the cursor box changes to reflect the new size and proportion.

5. In the Viewer menu bar, select **File | Close Other Viewers** to close the magnifier window.

## Viewer

Other methods of zooming in and out of imagery are Animated Zoom, Box Zoom, and Real-time Zoom.

### Animated Zoom

Animated Zoom enables you to zoom in and out of the Viewer's image in a series of steps that are similar to animation. The image is resampled after it is magnified or reduced.

#### Prepare

Display **lanier.img** in the Viewer.

1. Select **Session | Preferences**.
2. In the Preference Editor dialog, select **Viewer** from the **Category** list.
3. Click the checkbox for **Enable Animated Zoom**.
4. Click **User Save** then **Close** in dialog, and go back to the Viewer.
5. Click the Zoom In By Two icon.



The Viewer zooms into the image in a simulated animation by a factor of 2. The Viewer center is maintained.

6. Click the Zoom Out By Two icon.



The Viewer zooms out of the image in a simulated animation by a factor of 2. The Viewer center is maintained.

7. Click either the Interactive Zoom In or the Interactive Zoom Out icon.



8. Click on a location on the image.

The Viewer recenters the image to that location and zooms in or out in a simulated animation by a factor of 2.



---

*Animated zoom also works with **View | Zoom | In by X and Out by X**.*

### Box Zoom

Box Zoom is used to select a boxed area in the image. When zooming in or out by using the zoom recentering icons, the boxed image enlarges or reduces within the Viewer.

#### Prepare

Display **lanier.img** in the Viewer.

1. Select **Session | Preferences**.
2. In the Preference Editor dialog, select **Viewer** from the **Category** list.
3. Click to select **Enable Box Zoom**.
4. Click **User Save** then **Close** in dialog, and go back to the Viewer.
5. Click the Interactive Zoom In icon.
6. Click and drag a box in the image.

The selected area of the image is magnified to fit the Viewer.

7. Select the Interactive Zoom Out icon.
8. Click and drag a box in the image.

The area displayed in the Viewer is reduced to fit in the box. Space surrounding the reduced image is populated with available imagery.

### Real-time Zoom

When you select either of the Interactive Zoom tools, you can to zoom into and out of images in real time by holding the middle mouse button and moving the mouse upward and downward over the image.

*NOTE: You can also hold down the Control key and press on the left mouse button to zoom in real time.*

#### Prepare

Display **lanier.img** in the Viewer. There is no need to set up a preference for this feature.

1. Select either of the Interactive Zoom icons.
2. Position the cursor in the Viewer, and hold the middle mouse button.
3. Move the mouse forward to zoom in on the image.

The image magnifies at a constant rate, depending on how far forward you move the mouse.

4. Hold the middle mouse button and move the mouse backward.

The image reduces at a constant rate, depending on how far downward on the image you move the mouse.

### Display Two Images

Two or more Viewers can be geographically or spectrally linked so that when you roam in one image, that area is simultaneously displayed in the linked Viewer(s).

# Viewer

## Types of Linking

- Geographically linked—the same image area displays in all linked Viewers.
- Spectrally linked—enhancements made to an image are also made in other Viewers if that same image, or portions of it, are displayed in other Viewers.

## Prepare

**lanier.img** should be displayed on top of **Insoils.img** in a Viewer window, at a magnification of 2.

1. Drag on a lower corner of the Viewer so that it occupies the entire left half of the screen.
2. In the Viewer menu bar, select **View | Split | Split Horizontal**.  
The Viewer is divided in half, horizontally, to form two Viewers.
3. In the tool bar of the new Viewer, click the Open icon.



The Select Layer To Add dialog opens.

4. In the Select Layer To Add dialog under **Filename**, click on the file **Insoils.img**.
5. Click on the **Raster Options** tab at the top of the dialog.
6. Confirm that **Zoom by** is set to **1.00**.
7. Click **OK** in the Select Layer To Add dialog.

The file **Insoils.img** is displayed in the second Viewer.

## Link Viewers

1. In the first Viewer, select **View | Link/Unlink Viewers | Geographical**.  
The Link/Unlink Instructions display.
2. Move your pointer to the second Viewer.

The pointer becomes a Link symbol.



3. Move the pointer to the first Viewer.

The No Link symbol displays as the cursor in the first Viewer. Clicking in this Viewer discontinues the link operation.



4. To link the Viewers, click anywhere in the second Viewer.

The two Viewers are now linked. A white cursor box opens over the image in the second Viewer, indicating the image area displayed in the first Viewer.

You can move and resize this cursor box as desired, and the image area in the first Viewer reflects each change. This is similar to the magnification box you used earlier.

### Compare Images

1. Drag the cursor box in the second Viewer to a new location.

The image area selected in the second Viewer is displayed in the first Viewer.

2. Drag the scroll bars in the first Viewer to roam in the image.

The white cursor box in the second Viewer moves as the image area in the first Viewer changes.



*You could also use the Roam icon in the Viewer tool bar to roam over the image. Just move the hand across the Viewer image to change the view.*



### Unlink Viewers

1. In either Viewer, select **View | Link/Unlink Viewers | Geographical** to unlink the Viewers.

The Link/Unlink Instructions display.

2. Move the pointer to the other Viewer.



## Viewer

The unlink cursor displays.



3. Click anywhere inside the Viewer to unlink the Viewers.
4. In the menu bar of the second Viewer, select **File | Close**.

The second Viewer closes.

5. In the first Viewer, select **File | Clear** to clear the Viewer.

---

## Raster Menu Options

### Create an AOI Layer

These options allow you to define an AOI in the image, excluding other parts of the image. Specific processes can be applied to this AOI only, which can save considerable time and disk space. The option to use a specified AOI for processing is available from many dialogs throughout ERDAS IMAGINE.

This exercise tells you how to create an AOI layer that can be saved as a file and recalled for later use.

*NOTE: Each Viewer can display only one AOI layer at a time.*

#### Prepare

Display **lanier.img** in a Viewer. You must have an image displayed in the Viewer to create an AOI layer.

1. Select **File | New | AOI Layer** from the Viewer menu bar.  
ERDAS IMAGINE creates an AOI layer.
2. Select **View | Arrange Layers** from the Viewer menu bar to verify that the AOI layer has been created.

The Arrange Layers dialog opens, and should look similar to the following example:

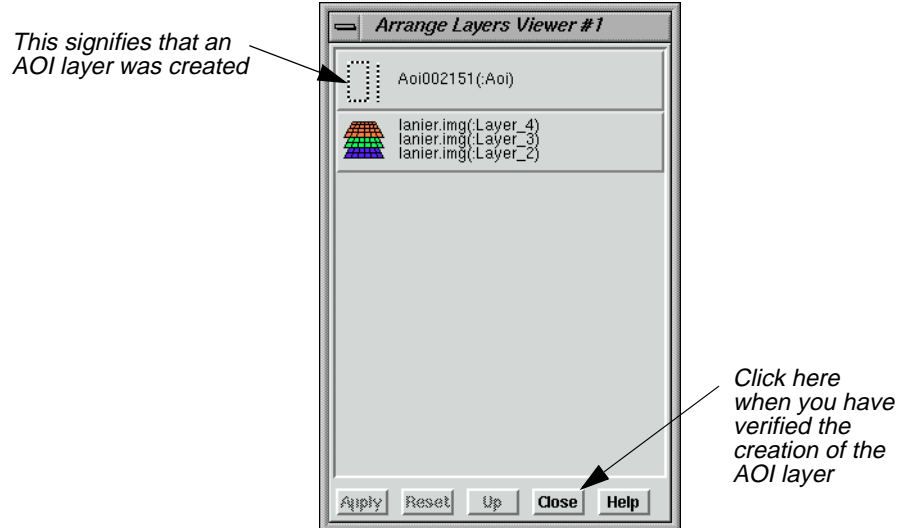

3. After verifying the creation of the AOI layer, click **Close** in the Arrange Layers dialog. Later, you are asked to name the layer and save it to a file.

## Open AOI Tools

1. Select **AOI | Tools** from the Viewer menu bar (or click the Tools icon on the tool bar).

The AOI tool palette displays.

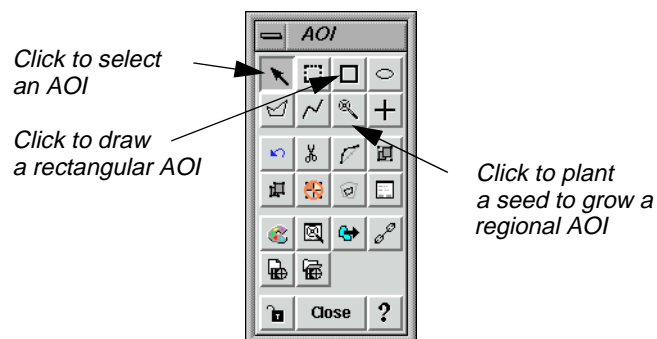

2. Click on the Rectangle icon in the AOI tool palette.



3. Move the cursor into the Viewer window. Drag and then release to draw a rectangle over the AOI. Include a portion of the water when designating the AOI.



# Viewer

A rectangular AOI displays in the Viewer.

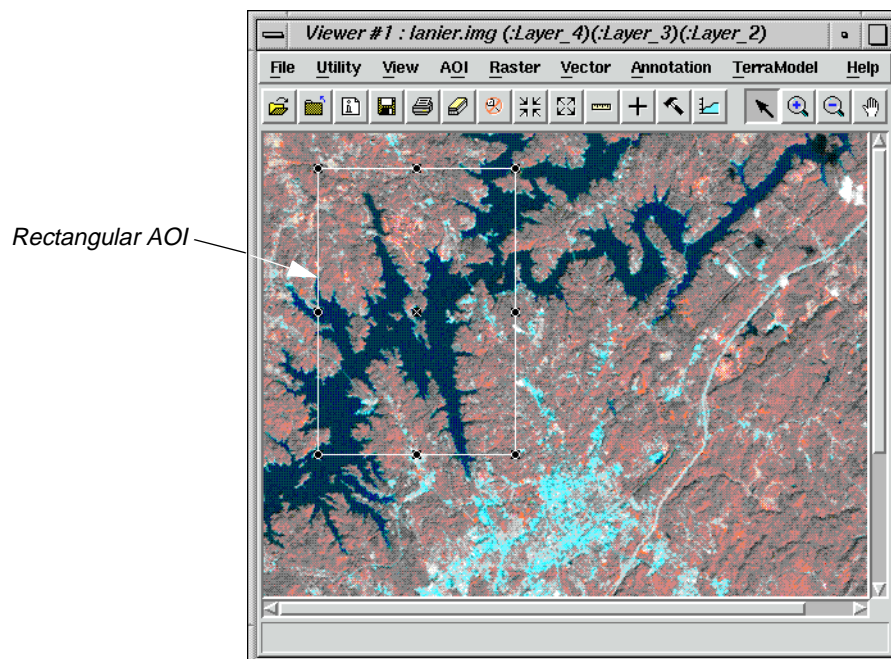

## Selecting AOIs

Following are some tips regarding the selection of the AOI:

- You can move the AOI by dragging the AOI to a new location.
- You can resize the AOI by dragging any of the handles at the corners and sides of the bounding box, or by pressing the space bar to enter precise coordinates.
- The **x** in the center of the bounding box marks the center coordinate of the AOI.

## Select Styles

1. Select **AOI | Styles** from the Viewer menu bar.

The AOI Styles dialog opens.



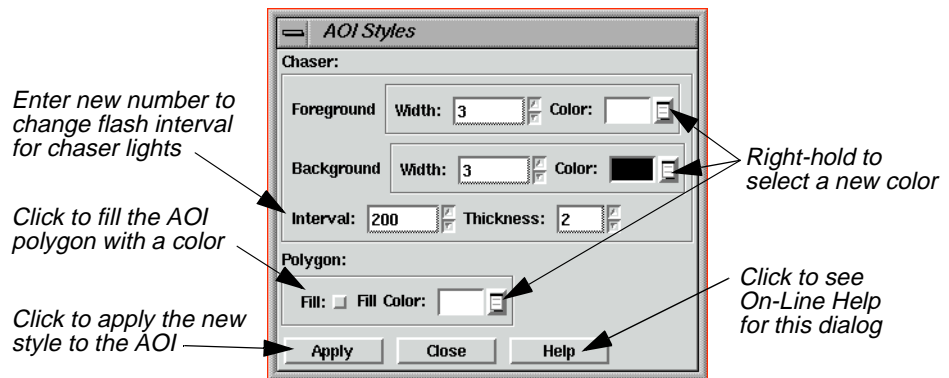

This dialog enables you to change the style of the AOI display.

2. Experiment in the AOI Styles dialog with the line widths and colors to find a style that looks best on the displayed image.
3. When you are finished, click **Close** in the AOI Styles dialog.

### Set Seed Properties

1. Next, select **AOI | Seed Properties** from the Viewer menu bar.

The Region Growing Properties dialog opens.

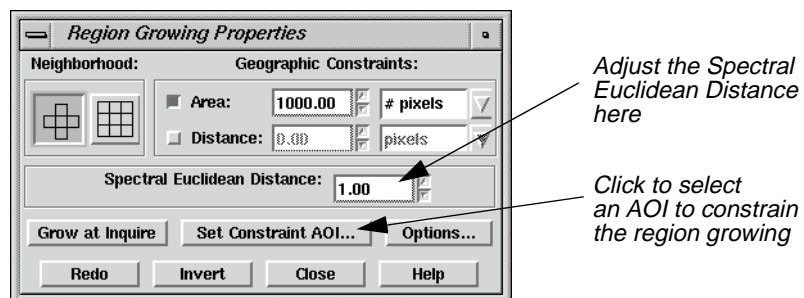

This dialog enables you to define the region that grows from the seed.

2. In the Region Growing Properties dialog, change the **Spectral Euclidean Distance** to **5.00**.
3. Click **Set Constraint AOI** in the Region Growing Properties dialog.

The Choose AOI dialog opens.

4. In the Choose AOI dialog, select **Viewer** under **AOI Source** and then click **OK**.



## Viewer

5. Click the Region Grow AOI icon in the AOI tool palette.



Click this tool to plant seeds, or points in the Viewer, from which to grow a regional AOI. The region grows in the Viewer as an AOI that can be selected.

6. Move the cursor into the Viewer window and click on the water inside the rectangular AOI to indicate where you want the region growing to take place.

A status meter displays in the status bar of the Viewer. You may click **Cancel** to terminate the region grow process. The meter dismisses when the region growing process is complete. The area you selected in the Viewer is surrounded by a second bounding box and chaser lights.

7. Click **Close** in the Region Growing Properties dialog.

### Save AOI

1. Select **File | Save | AOI Layer As** from the Viewer menu bar.

The Save AOI As dialog opens. This dialog allows you to save the selected AOIs as a layer (.aoi extension) that can be used again for other functions.

2. Enter a name for the AOI layer under **Save AOI as** (the .aoi extension is added automatically). Pay special attention to the directory where the file is saved, so you can find the layer later.



*If you wanted to save specific AOIs only, you could turn on the **Selected Only** checkbox in the Save AOI As dialog, and only selected AOIs would be saved to a file.*

3. Click **OK** in the Save AOI As dialog.

This layer can now be used in any dialog where a function can be applied to a specific AOI layer. You can also edit this layer at any time, adding or deleting areas.

### Arrange Layers

1. Select **View | Arrange Layers** from the Viewer menu bar.

The Arrange Layers dialog opens.

2. In the Arrange Layers dialog, right-hold over the AOI Layer and select **Delete Layer** from the **AOI Options** menu.
3. Click **Apply** and then **Close** in the Arrange Layers dialog.

The file **lanier.img** is redisplayed in the Viewer without the AOI layer.

## Adjust Image Contrast

When images are displayed in ERDAS IMAGINE, a linear contrast stretch is applied to the data file values, but you can further enhance the image using a variety of techniques.

### Prepare

The file **lanier.img** should be displayed in a Viewer.

1. In the Viewer menu bar, select **Raster | Contrast | Brightness/Contrast**.

The Contrast Tool dialog opens.

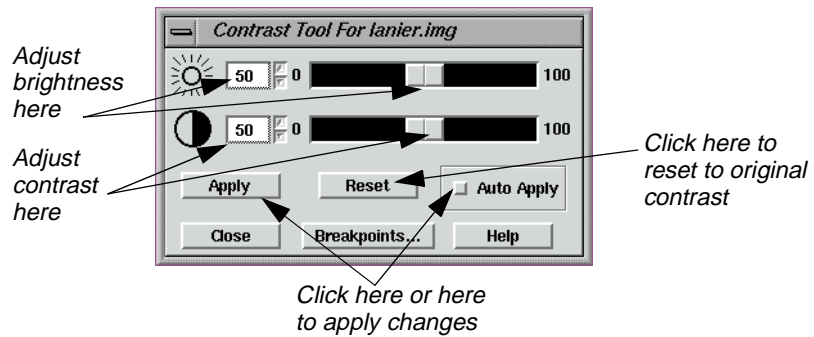

2. In the Contrast Tool dialog, change the numbers and/or use the slider bars to adjust the image brightness and contrast.
3. Click **Apply**.  
The image in the Viewer is redisplayed with new brightness values.
4. Click **Reset** and **Apply** in the Contrast Tool dialog to undo any changes made to the Viewer image.
5. Click **Close** in the Contrast Tool dialog.

### Use Piecewise Linear Stretches

1. In the Viewer menu bar, select **Raster | Contrast | Piecewise Contrast**.

The Contrast Tool dialog for piecewise contrast opens.



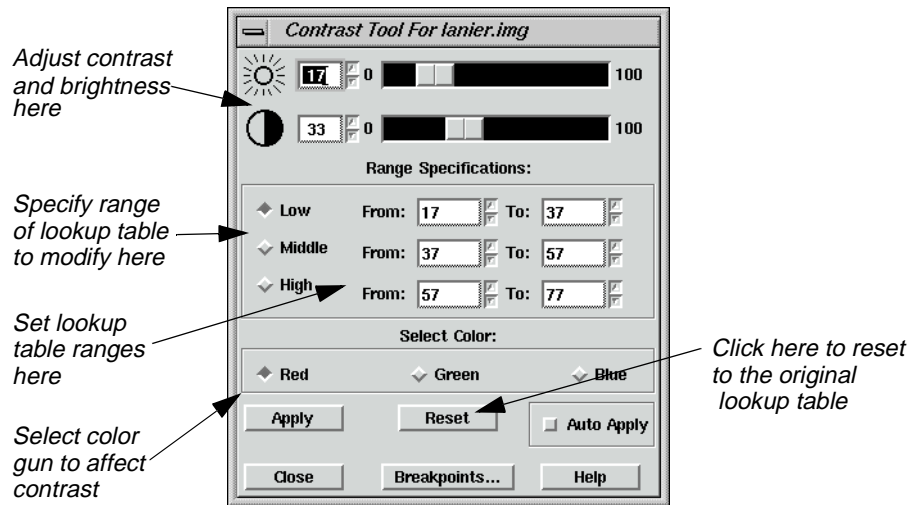

## The Contrast Tool

This tool enables you to enhance a particular portion of an image by dividing the lookup table into three sections: low, middle, and high. You can enhance the contrast or brightness of any section using a single color gun at a time. This technique is very useful for enhancing image areas in shadow, or other areas of low contrast.

The brightness value for each range represents the midpoint of the total range of brightness values occupied by that range.

The contrast value for each range represents the percent of the available output range that particular range occupies.

As one slider bar is moved, the other is automatically adjusted, so that there is no gap in the lookup table. This tool is set up so that there are always pixels in each data file value from 0 to 255. You can manipulate the percentage of pixels in a particular range, but you cannot eliminate a range of data file values.

2. With your pointer over the image in the Viewer, right-hold **Quick View | Inquire Cursor**.

The Inquire Cursor dialog opens and an Inquire Cursor is placed in the Viewer.

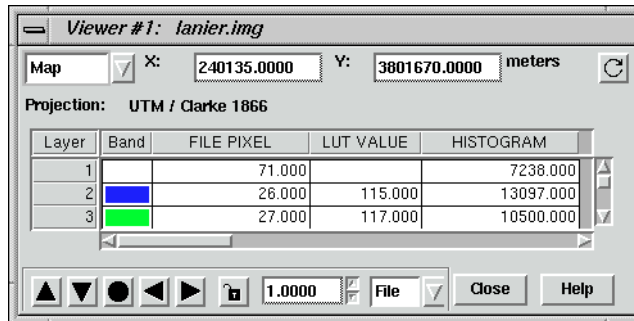

3. In the Viewer, drag the intersection of the Inquire Cursor to the lake. Move the Inquire Cursor over the water while keeping an eye on the lookup table values in the blue color gun, as reported in the Inquire Cursor dialog.

This gives you an idea of the range of data file values in the water. You can stretch this range to bring out more detail in the water.

4. In the Contrast Tool dialog, click **Blue** under **Select Color**.
5. Under **Range Specifications**, set the **Low** range **From 34 To 55** and press Return on your keyboard.
6. Drag the Brightness slider bar (the top slider bar) to **50**.
7. Click **Apply** in the Contrast Tool dialog.

The water now has more contrast and shows more detail.

If your image is at a magnification of 1, this new detail may be difficult to see. You can zoom in to a magnification of 2 using the **Quick View** menu in the Viewer.

8. In the Contrast Tool dialog, click **Reset** and then **Apply** to return the image to the original lookup table values.
9. Click **Close** in the Contrast Tool dialog.
10. Click **Close** in the Inquire Cursor dialog.

### Manipulate Histogram

1. In the Viewer menu bar, select **Raster | Contrast | Breakpoints**.

The Breakpoint Editor opens.

# Viewer

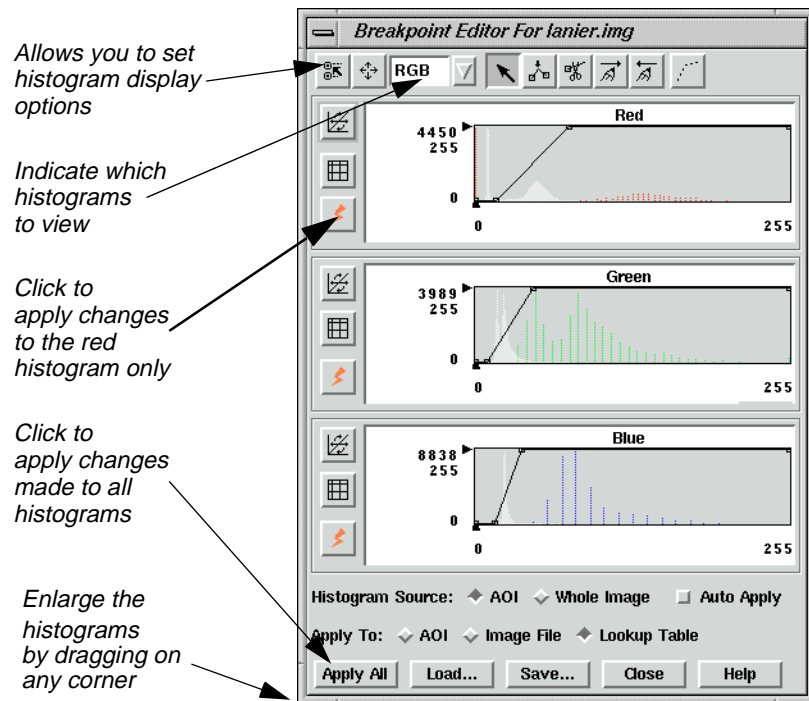

2. Click on the popup list at the top of the Breakpoint Editor and select **Red**.

Each of the three histogram graphics in the Breakpoint Editor can be expanded up to full size by selecting the appropriate histogram from the popup menu at the top of the Break Point Editor. The parts of the histogram graphic are described in the following illustration.

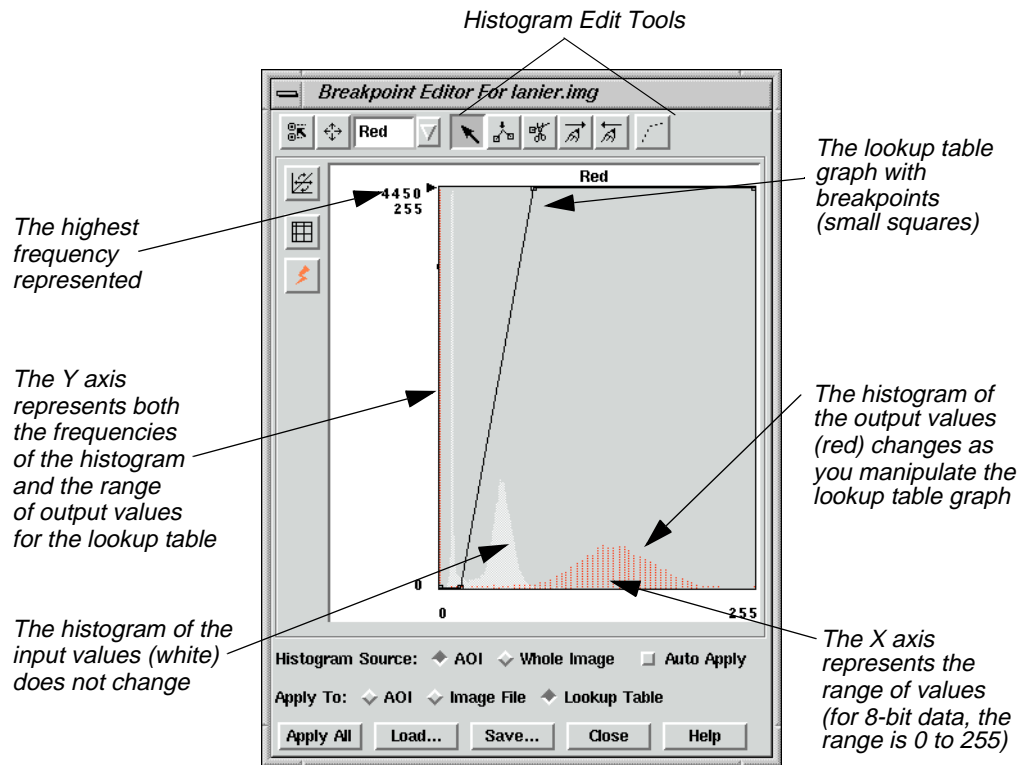

3. Click on the popup list at the top of the Breakpoint Editor and select **RGB**.  
All three histograms redisplay in the Breakpoint Editor.
4. Experiment by dragging the breakpoints of the lookup table graphs in the different color guns (**Red, Green, and Blue**).
5. Click **Apply All** in the Breakpoint Editor to view the results of your changes in the image.
6. To undo the edits you just made, select **Raster | Undo** from the Viewer menu bar.

## Adjust Shift/Bias

1. In the Breakpoint Editor, click the Shift/Bias icon on the tool bar.



The Shift/Bias Adjustment dialog opens.

## Viewer

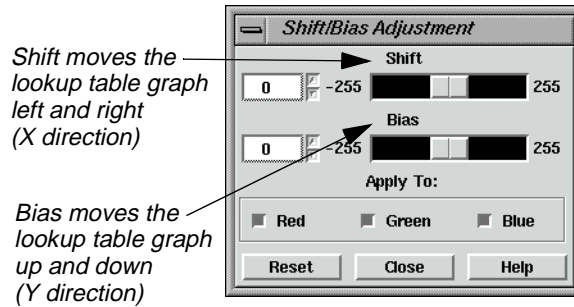

The lookup table graph and the output histogram are updated in the Histogram Tool dialog as you manipulate the information in the Shift/Bias Adjustment dialog.

2. In the Shift/Bias Adjustment dialog, drag the **Shift** slider bar to the right.

Notice that the value in the number field to the left increases as you move the slider bar. This is the number of pixels that the lookup table graph is moved.

3. In the Shift/Bias Adjustment dialog, double-click on the number in the **Shift** number field and change the number field to **20**. Press Enter on your keyboard.
4. In the Breakpoint Editor, click **Apply All**.

The image is redisplayed using the new lookup table. It is very dark.

5. In the Shift/Bias Adjustment dialog, return the **Shift** value to **0**.
6. In the Breakpoint Editor, click **Apply All** to return the image to its original contrast.
7. Repeat steps (2. through step 6., using the **Bias** option.
8. When you are finished, click **Close** in the Shift/Bias Adjustment dialog.

### Use Mouse Linear Mapping

1. In the Breakpoint Editor, click the Red Mouse Linear Mapping icon, which is located on the left border of the **Red** histogram.



The Red Mouse Linear Mapping dialog opens.



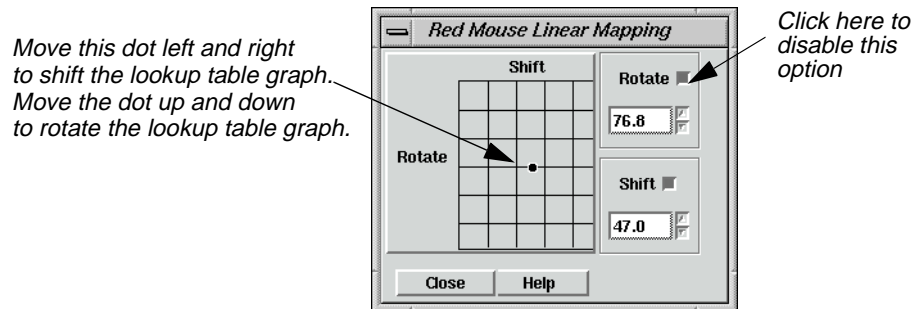

### Linear Mapping

Moving the dot in the center of the grid left and right shifts the lookup table graph in the histogram graphic left or right. Moving the dot up and down rotates the lookup table graph, changing the slope. Up rotates the graph counterclockwise and down rotates the graph clockwise.

As the dot is moved, the numbers on the right side of the dialog are automatically updated. The **Rotate** number reports the angle of the rotation ramp, with 180 being a straight horizontal line and 90 being a straight vertical line. The **Shift** number reports the pixel value at the center of the lookup table graph.

2. In the Red Mouse Linear Mapping dialog, click the **Rotate** button to disable the rotate option.
3. Drag the dot in the center of the grid left or right to shift the red lookup table graph.
4. In the Breakpoint Editor, click the Run icon for the red histogram to update the image in the Viewer.



5. In the Red Mouse Linear Mapping dialog, click the **Rotate** button to turn it on and the **Shift** button to turn it off.
6. Drag the dot in the grid up or down to change the slope of the lookup table graph.
7. Click the Run icon for the red histogram to update the Viewer image.
8. Click **Close** in the Red Mouse Linear Mapping dialog.
9. With your cursor over the red histogram graph, right-hold **Graph Options | Undo All Edits**.
10. Click **Apply All** in the Breakpoint Editor to return the Viewer image to its original contrast.
11. Click **Close** in the Breakpoint Editor.
12. Select **File | Clear** from the Viewer menu bar.



---

## Raster Editor

The Raster Editor enables you to edit portions of the displayed image using various tools in the Viewer **Raster** menu. When a specific raster editing tool is in use, that tool locks the Viewer, therefore, work with one tool must be completed before opening another one.

All of the dialogs that accompany the raster editing tools contain a preview window, which enables you to view the changes you make to the Viewer image before you click **Apply**.

### Prepare (UNIX)

You must have a writable file displayed to use this function. Follow the steps below to create a writable file to work with.

1. In a command window, copy **Indem.img** to **testdem.img** by typing the following:

```
cp $IMAGINE_HOME/examples/Indem.img /your directory/testdem.img
```

Press Return on your keyboard.

2. Change read/write permissions by typing the following in the command window:

```
chmod 644 testdem.img
```

Press Return on your keyboard and close the command window.

### Prepare (PC)

1. Open the Explorer.
2. Copy **Indem.img** from the <IMAGINE\_HOME>/examples directory to the directory of your choice.
3. Right-click and select **Rename** to rename the file **testdem.img**.
4. Right-click on the file, and select **Properties**.
5. In the **Attributes** section of the **General** tab, make sure **Read-only** is not checked.
6. Click **OK** in the Properties dialog.

### Open the Image

1. Open **testdem.img** in the Viewer.

This is a DEM file of the Gainesville, Georgia area, corresponding to the **lanier.img** data you have been using.

2. If it is not already displayed, select **AOI | Tools** from the Viewer menu bar to open the AOI tool palette.

The AOI tool palette displays. The AOI tools are used to define the area(s) to be edited.

3. Click on the Ellipse icon in the AOI tool palette and then drag near the center of the Viewer image to draw an elliptical AOI, measuring about 1" to 2" in diameter.



When the mouse button is released, the AOI is surrounded by chaser lights and a bounding box.

## Interpolate

1. In the Viewer menu bar, select **Raster | Interpolate**.

The Interpolate dialog opens.

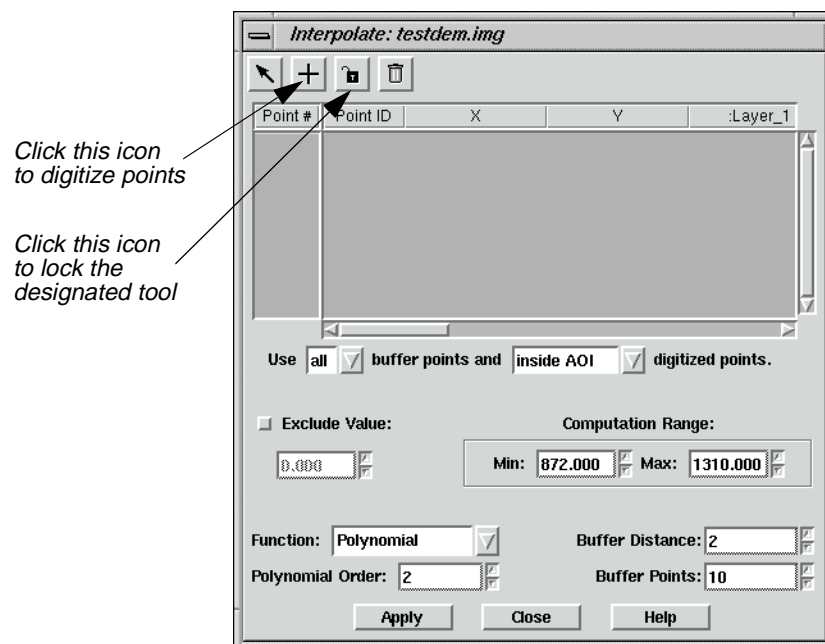

### Digitize Points

Digitizing points helps you to control the overall surface generated by the raster editing function. However, you should digitize points only when you know the general areas in the AOI that are bad. The Interpolation function uses the data values of the digitized points and the boundary of the AOI to generate a new surface.

1. Click on the Digitize Points icon in the Interpolate dialog, then click on the Lock icon.



2. Click at least 12 times in the AOI in the Viewer to digitize 12 points.

## Viewer

The point coordinates display in the CellArray in the Interpolate dialog.

3. When you are finished digitizing points, click the Lock icon in the Interpolate dialog again to disable it.
4. In the Interpolate dialog under **Buffer Points**, enter **25** to allow up to 25 points in the computation.
5. In the Interpolate dialog under **Polynomial Order**, enter **3** to increase the polynomial order of interpolation.
6. Click **Apply** in the Interpolate dialog.
7. An Attention box displays, asking if you want to remove the data stretch lookup table. Click **Yes**.
8. A Warning box displays, suggesting that you recalculate the statistics. Click **OK**.

The new surface displays inside the AOI.

9. Observe the changes in the AOI and then select **Raster | Undo** from the Viewer menu bar.

The data values return to the original values. This lets you undo the edit without changing the original data values.

*NOTE: **Undo** works only for the last edit applied.*

10. Click **Close** in the Interpolate dialog.

## Fill with Value

### Set Constant Value

If the area to be edited is a flat surface, you may use a constant value to replace the bad data values.

1. Select **Raster | Fill** from the Viewer menu bar.

The Area Fill dialog opens.



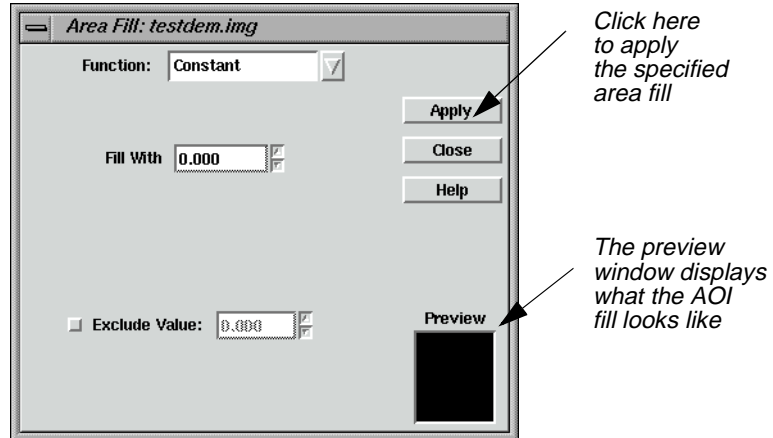

2. In the Area Fill dialog, click **Apply** to accept the Constant function and its defaults.  
The AOI is replaced with a Constant value of zero—the area is black.
3. Select **Raster | Undo** from the Viewer menu bar.  
The image returns to the original values.
4. In the Area Fill dialog, enter **1500** in the **Fill With** number field and click **Apply**.  
Now the AOI fill area is white.
5. Select **Raster | Undo** from the Viewer menu bar.  
The image returns to the original values.

### Set Global Value

1. In the Area Fill dialog, click on the **Function** popup list and select **Majority**.  
This option uses the majority of the pixel values in the AOI to replace all values in the AOI.
2. Click **Apply** in the Area Fill dialog.  
The AOI displays the newly generated surface.
3. After observing the changes, select **Raster | Undo** from the Viewer menu bar.
4. Click **Close** in the Area Fill dialog.
5. Select **File | Clear** from the Viewer menu bar.  
Save the AOI layer in the Viewer if you like.

# Viewer

## Raster Attribute Editor

You can easily change the class colors in a thematic file. Here, you change the colors in **Insoils.img**.

### Prepare

Display **Insoils.img** in a Viewer.

1. In the Viewer menu bar, select **Raster | Attributes**.

The Raster Attribute Editor opens.

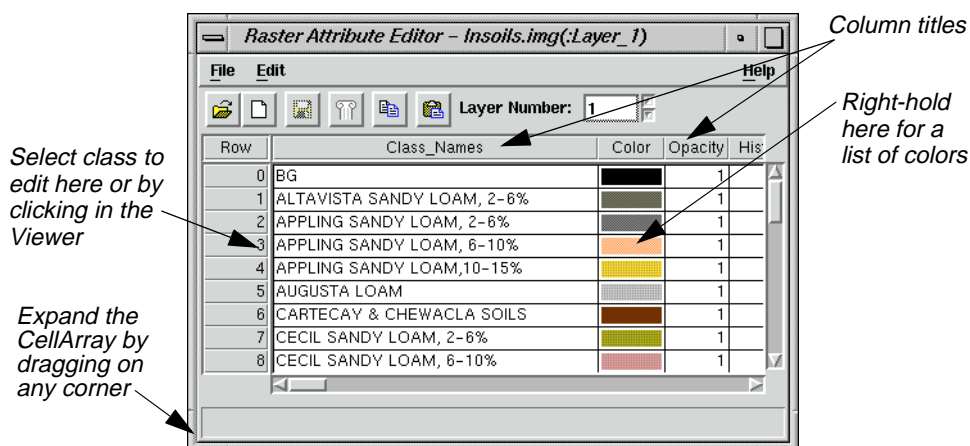

The CellArray in the Raster Attribute Editor is for manipulating the raster attributes and selecting classes to edit. To change the color of a class, you can select that class in two ways:

- with your cursor in the Viewer, click on the class you want to edit, or
- with your cursor in the Row column of the Raster Attribute Editor CellArray, click the class to edit.

You use both methods in the following examples.

2. Move your cursor inside the Viewer and click on an area.

That class is highlighted in yellow in the Raster Attribute Editor CellArray, and the current color assigned to that class is shown in the bar underneath the **Color** column.

3. In the CellArray, right-hold with your cursor over the **Color** patch for the selected class and select **Other**.

The Color Chooser dialog opens.

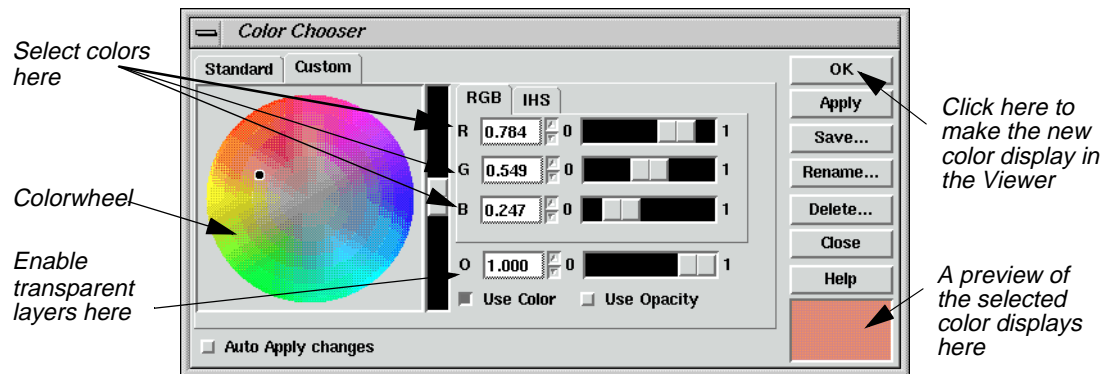

A dot is present on the colorwheel itself, indicating the current color of the selected class. This color is also shown in the preview window in the lower, right corner of the dialog.

4. In the Color Chooser dialog, change the color of the selected class by dragging the dot on the colorwheel to another spot on the colorwheel. Then, click the **Apply** button.

The selected class changes color in both the Viewer image and the Raster Attribute Editor CellArray.



*You can also change the class color using any of these methods:*

- 1) enter **RGB** (red, green, blue) or **IHS** (intensity, hue, saturation) values in the Color Selector number fields in the Color Chooser dialog, or
- 2) click the **Standard** tab in the Color Chooser dialog to select from a list of predefined colors, or
- 3) move the slider bars in the Color Chooser dialog

5. In the Raster Attribute Editor, select **Edit | Undo Last Edit**.

The change you made in step 4. is undone.

6. Click **Close** in the Color Chooser dialog.
7. Select **File | Close** from the Raster Attribute Editor.

## Make Layers Transparent

If you have more than one file displayed in a Viewer, you can make specific classes or entire files transparent. In this example, you make the overlaid soils partially transparent so that the Landsat TM information shows through.

1. Display **lanier.img** over **Insoils.img** in a Viewer. Be sure that the **Clear Display** checkbox is disabled under **Raster Options** when you are in the Select Layer To Add dialog.
2. In the Viewer menu bar, select **View | Arrange Layers**.

The Arrange Layers dialog opens.

## Viewer

3. In the Arrange Layers dialog, drag the **Insoils.img** box on top of the **lanier.img** box.
4. Click **Apply**, then **Close** in the Arrange Layers dialog.

### Edit Raster Attributes

1. Select **Raster | Attributes** from the Viewer menu bar.

The Raster Attribute Editor displays.

The objective is to select a class that covers a section of **lanier.img** that you would like to see through **Insoil.img**. Then, you can make that class transparent.

2. Select the class to become transparent, either by clicking in the Viewer or in the **Row** column of the CellArray.
3. In the Raster Attribute Editor CellArray, right-hold on the color button in the **Color** column of the selected class and drag to select **Other** from the popup list that displays.

The Color Chooser dialog opens.

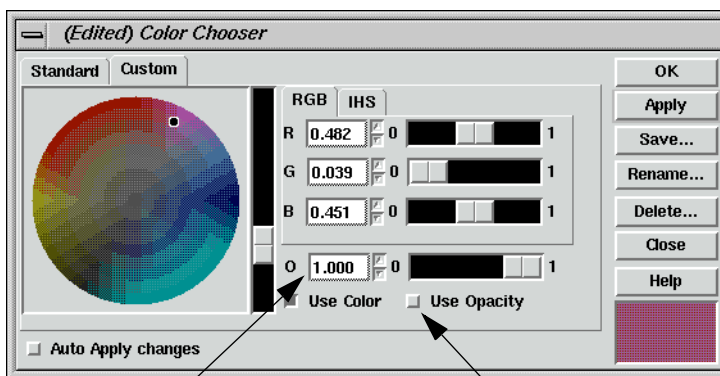

*Click here and enter .40, or use the slider bar at right to set the number field to .40*

*Click checkbox to use opacity*

4. In the Color Chooser dialog, click on the **Use Opacity** checkbox.
5. At **O** (which stands for Opacity), change the number to **.40** (opacity percentage of 40) using either the number field or the slider bar.
6. Click **Apply** in the Color Chooser dialog.

The selected color becomes partially transparent, allowing you to see **lanier.img** underneath.
7. Experiment with different ways to change class color and opacity.
8. When you are finished, click **Close** in the Color Chooser dialog.



### Manipulate CellArray Information

1. With your cursor in the title bar of the Raster Attribute Editor, drag it to the top of your screen.
2. Drag one of the bottom corners of the Raster Attribute Editor down until all rows of the CellArray are visible.
3. Drag the corners of the Raster Attribute Editor horizontally until all columns are visible.

*NOTE: The CellArray probably occupies most of your screen.*

#### Select Rows

To select one row, simply click in the **Row** column of the desired row. That row is highlighted in yellow. You can select sequential rows by middle-clicking in additional rows. Shift-click in a selected row to deselect a row. You can also select rows using the **Row Selection** menu that opens when you right-hold in the **Row** column.

#### Select Columns

To select one column, click in the title box of the desired column. That column is highlighted in blue. You can select multiple columns by middle-clicking in the title bar of additional columns. Shift-click in a selected column to deselect it.

#### Choose Column Options

Many column options are available from the **Column Options** menu, which opens when you right-hold in a column title bar. You can have multiple columns and rows selected at the same time.

You use many of these features in the following steps.

#### Resize Columns

You can make each column in the CellArray narrower and then reduce the width of the entire dialog, so that it takes up less room.

### Edit Column Properties

1. Click on the Column icon in the Raster Attribute Editor.



The Column Properties dialog opens.

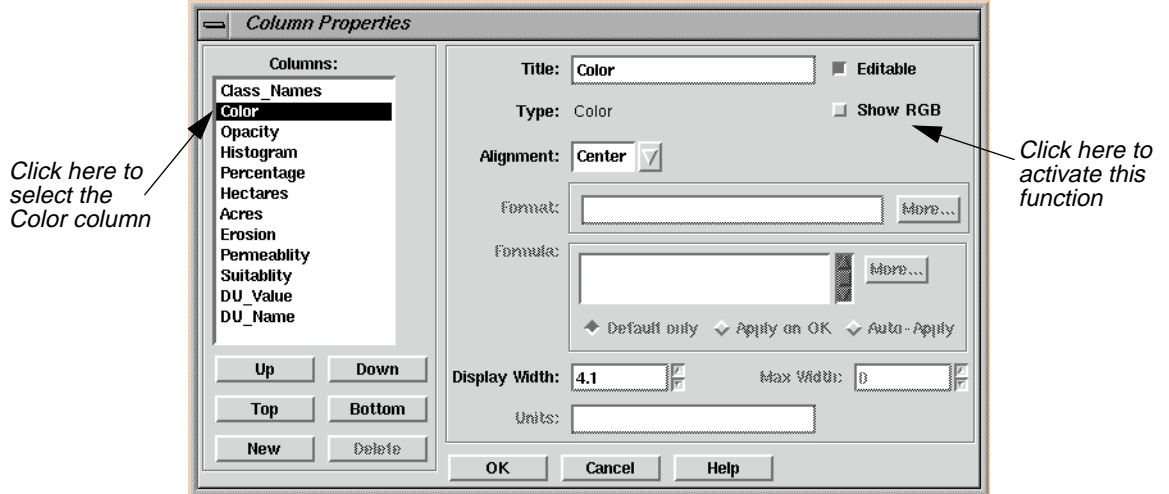

2. In the Column Properties dialog, select **Color** under **Columns** and activate the **Show RGB** checkbox.
3. Click **OK** in the Column Properties dialog.
4. In the Raster Attribute Editor, place your cursor on the column separator in the header row between the **Color** and **Red** columns.

The cursor changes from the regular arrow to a double-headed arrow. You can now change the size of the **Color** column.

5. Drag the double-headed arrow to the right to make the **Color** column wider.
6. Repeat this procedure, dragging the double-headed arrow to the left, to narrow the other columns.

### Generate Statistics

1. In the Raster Attribute Editor CellArray, select the entire **Red** column by clicking in the **Red** title box.

The entire column is highlighted in blue.

2. With your cursor in the **Red** title box, right-hold **Column Options | Compute Stats**.

The Statistics dialog opens.

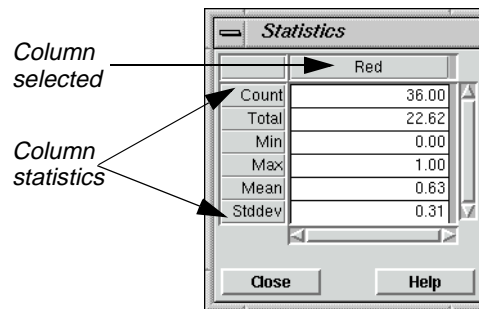

The Statistics for the column selected are reported.

### Column Statistics

These statistics include:

- **Count**—number of classes selected
- **Total**—sum of column figures (in this example, total area)
- **Min**—minimum value represented in the column
- **Max**—maximum value represented in the column
- **Mean**—average value represented (**Total/Count**)
- **Stddev**—standard deviation

3. Click **Close** in the Statistics dialog.

### Select Criteria

1. In the Raster Attribute Editor CellArray, select the **Class\_Names** column by shift-clicking in the **Class\_Names** title box.

Now the **Class\_Names** and **Red** columns are both selected; both columns are highlighted in blue.

Next, you generate a report that lists all of the classes and the area covered by each. You do not include classes with an area of 0 (zero).

2. With your cursor in the **Row** column (not the header row of the **Row** column), right-hold **Row Selection | Criteria**.

The Selection Criteria dialog opens.

## Viewer

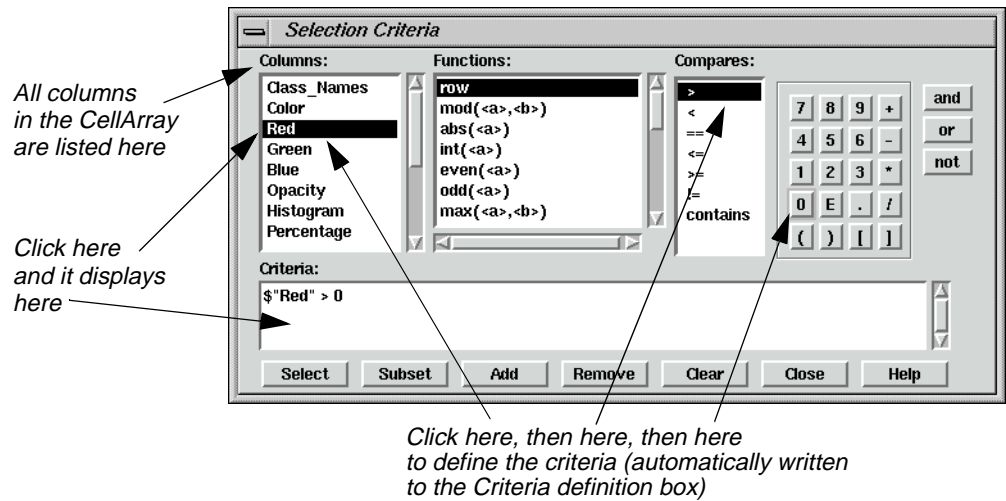

3. In the Selection Criteria dialog under **Columns**, click **Red**.

**“Red”** is written in the **Criteria** definition box at the bottom of the dialog.

4. Under **Compares**, click **>**.
5. In the calculator, click **0**.

The Criteria should now read:

**\$ “Red” > 0**

This criteria selects all classes in the CellArray with an area that is greater than 0.

6. Click **Select** in the Selection Criteria dialog to select these rows in the CellArray.

All rows except 0, 12, and 34 are selected (i.e., highlighted in yellow). These rows are not selected because the opacity for each of these categories is 0.

7. Click **Close** in the Selection Criteria dialog.

### Generate Report

1. With your cursor in a **Class\_Names** title box, right-hold **Column Options | Report**.

The Report Format Definition dialog opens.

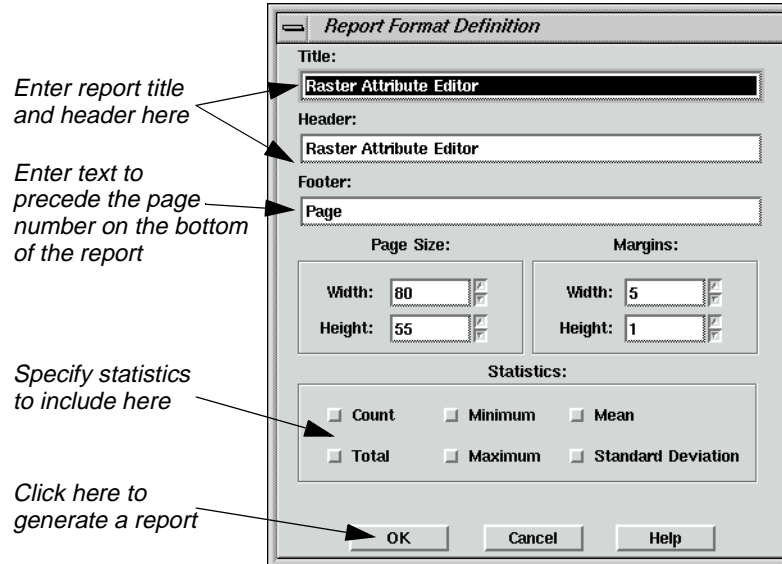

2. In the Report Format Definition dialog under **Title**, add **for Insoils.img** to the default text string.
3. Under **Header**, add **for Insoils.img** to the default text string.
4. Under **Statistics**, click on each checkbox to include all available statistics in the report.
5. Click **OK** in the Report Format Definition dialog to generate the report.

A Job Status dialog opens, indicating the progress of the function.

When the function is complete, the report displays in an IMAGINE Text Editor.



## Viewer

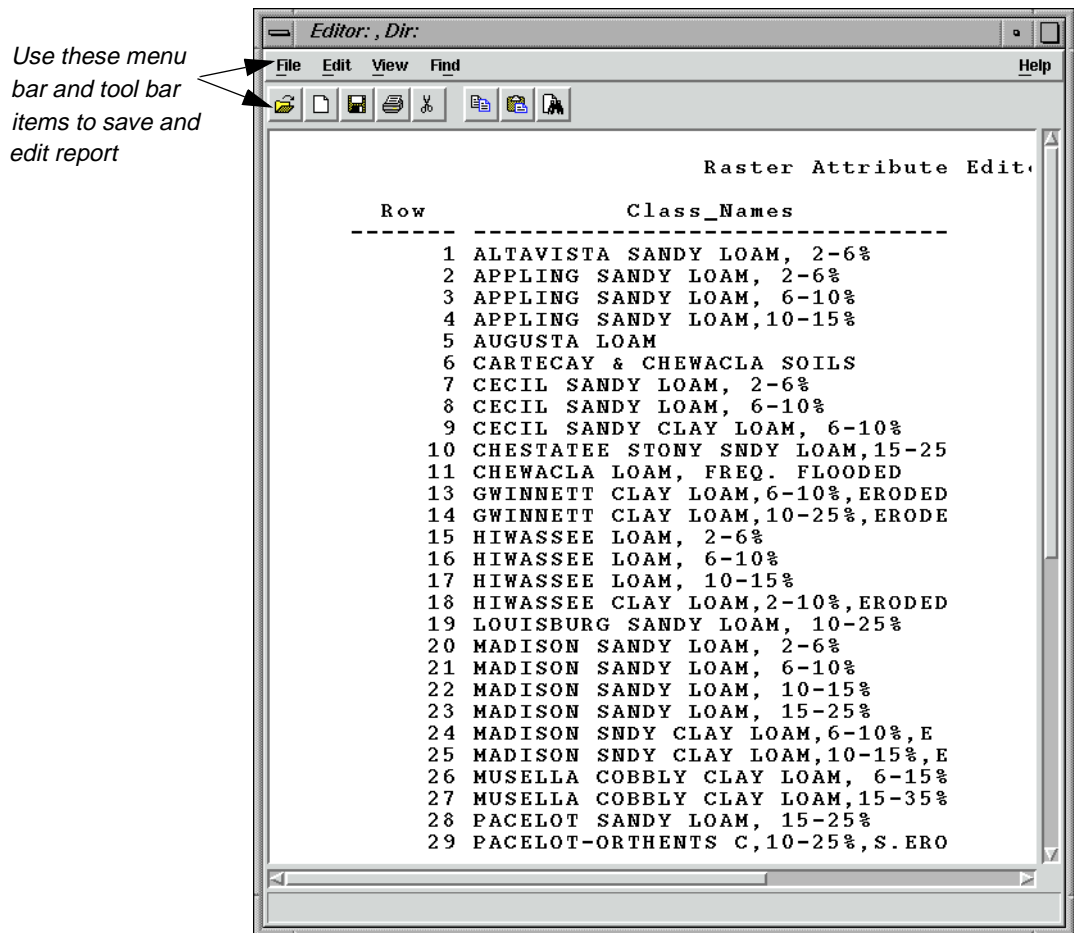

6. To save the report, in the Text Editor menu bar, select **File | Save As**.

The Save As dialog opens.

7. Enter a name for the report, such as **soilsreport.txt**.

8. Click **OK** in the Save As dialog.

The file name is written in the title bar of the Text Editor window.

9. In the Text Editor menu bar, select **File | Close**.

10. Select **File | Close** from the Raster Attribute Editor.

Save your changes to the Raster Attribute Editor if you like.

11. In the Viewer tool bar, click the Erase icon to clear the window.



---

**Profile Tools****Prepare**

ERDAS IMAGINE should be running and a Viewer should be open.

**Display Spectral Profile**

The spectral profile display is fundamental to the analysis of hyperspectral data sets. As the number of bands increases and the band widths decrease, the remote sensor is evolving toward the visible/infrared spectrometer. The reflectance (DN) of each band within one (spatial) pixel can be plotted to provide a curve approximating the profile generated by a laboratory scanning spectrometer. This allows estimates of the chemical composition of the material in the pixel. To use this tool, follow the steps below.

1. In the Viewer menu bar, select **File | Open | Raster Layer**.

The Select Layer To Add dialog opens.

2. In the Select Layer To Add dialog, select **hyperspectral.img** under **Filename**.
3. Click the **Raster Options** tab at the top of the dialog.
4. In the **Raster Options**, click the **Fit to Frame** checkbox to activate it and then click **OK**.

The file **hyperspectral.img** is displayed in the Viewer.

5. In the Viewer menu bar, select **Raster | Profile Tools**.

The Select Profile Tool dialog opens.

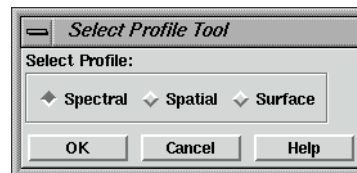

6. Accept the **Spectral** default and click **OK** in the Select Profile Tool dialog.

The Spectral Profile viewer opens.



# Viewer

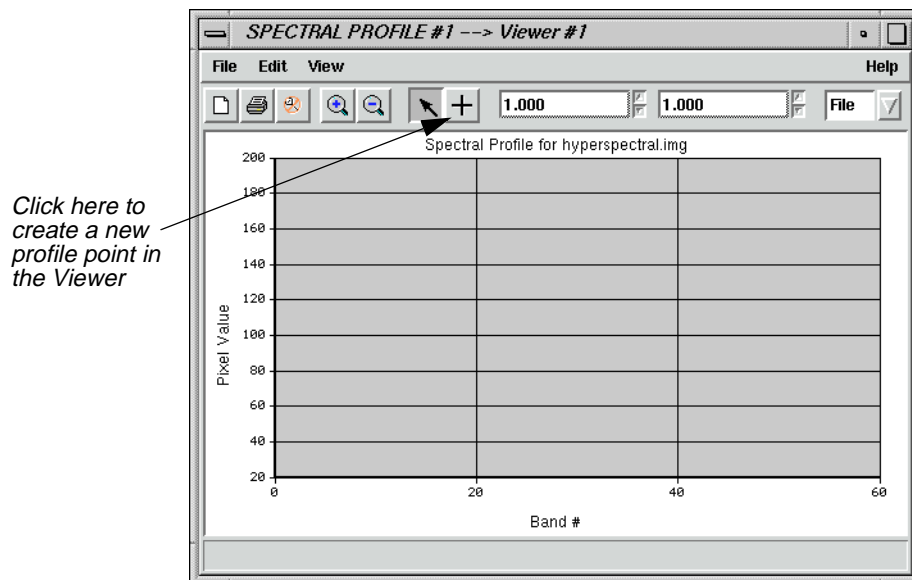

7. In the Spectral Profile viewer, click on the Create icon and then select a pixel of interest by clicking it in the Viewer image.



The data for the selected pixel are displayed in the Spectral Profile viewer.

*NOTE: The pixel can be moved around the displayed image by dragging it.*

## Analyze Data

1. In the Spectral Profile viewer menu bar, select **Edit | Chart Options**.

The Chart Options dialog opens.



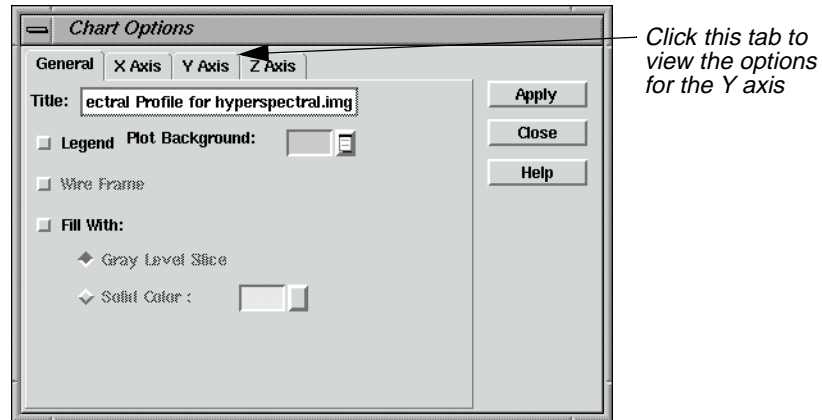

2. In the Chart Options dialog, click on the **Y Axis** tab at the top of the dialog.
3. Set **Min** to **20** and **Max** to **180** to control the numerical range.
4. Click **Apply** and then **Close** in the Chart Options dialog.

The selected range is shown in detail in the Spectral Profile viewer.

5. In the Spectral Profile viewer menu bar, select **Edit | Plot Stats**.

The Spectral Statistics dialog opens.

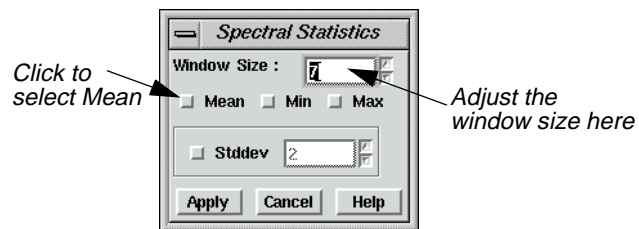

6. In the Spectral Statistics dialog, change the **Window Size** to **7**.
7. Select **Mean** and click **Apply**.

The mean (within the selected window) of Profile 1 is depicted on the graph.

8. Click **Cancel** in the Spectral Statistics dialog.
9. Select **File | Close** from the Spectral Profile viewer.

## Wavelength Axis

Data tapes containing hyperspectral imagery commonly designate the bands as a simple numerical sequence. When plotted using the profile tools, this yields an x-axis labeled as 1, 2, 3, 4, etc. Elsewhere on the tape or in the accompanying documentation is a file which lists the center frequency and width of each band. This information should be linked to the image intensity values for accurate analysis or comparison to other spectra, such as the Spectra Libraries.

To do this, the band position information must be entered into a linkable format, which is an **.saf** file. An example of this format can be seen by using a **texteditor** or **vi** command to view one of the **.saf** files in <IMAGINE\_HOME>/etc. Once this file is created, it can be linked with the Spectral Profile by using the **Edit | Use Sensor Attributes** option.

## Display Spatial Profile

The Spatial Profile display function allows the analyst to view the reflectance(s) of the pixels along a user-defined polyline. The display can be viewed in either two-dimensional (one band) or perspective three-dimensional (multiple bands) mode. To use this tool, follow the steps below.

### Prepare

The file **hyperspectral.img** should be displayed in a Viewer, with the **Fit to Frame** checkbox activated.

1. In the Viewer menu bar, select **Raster | Profile Tools**.

The Select Profile Tool dialog opens.

2. Click on the **Spatial** button in the Select Profile Tool dialog and then click **OK**.

The Spatial Profile viewer opens.

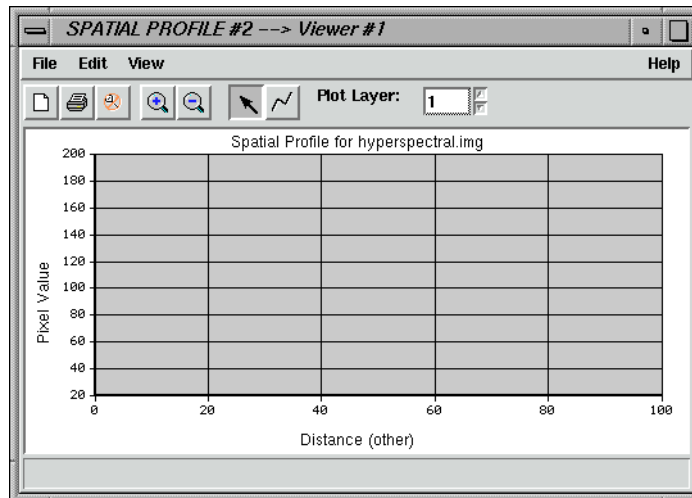

3. Click on the Polyline icon in the Spatial Profile viewer tool bar and then draw a polyline on the image in the Viewer. Click to set vertices and middle-click to set an endpoint.



The spatial profile is displayed in the Spatial Profile viewer.

### Analyze Data

1. Select **Edit | Plot Layers** from the Spatial Profile viewer menu bar.

The Band Combinations dialog opens.

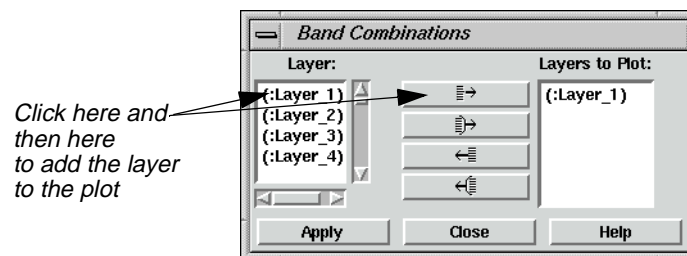

2. Add Layers **2** and **3** to the **Layers to Plot** column by individually selecting them under **Layer** and clicking the Add Selected Layer button.



## Viewer

3. Click **Apply** and then **Close** in the Band Combinations dialog.

Layers 1, 2, and 3 are plotted in the Spatial Profile viewer.

*NOTE: Moving the cursor around in the Spatial Profile viewer gives you the pixel values for the x and y coordinates of the layers.*

4. In the **Plot Layer** box to the right of the tool bar in the Spatial Profile viewer, click on the up arrow to view layers **4** and **5**.
5. Select **Edit | Plot Layers** from the Spatial Profile viewer to again bring up the Band Combinations dialog.
6. In the Band Combinations dialog, click the Add All button.



7. Click **Apply** and **Close**.

As in the Spectral Profile viewer, you can select **Edit | Chart Options** to optimize the display.

8. Select **File | Close** from the Spatial Profile viewer menu bar.

## View Surface Profile

The Surface Profile can be used to view any layer (band) or subset in the data cube as a relief surface. To use this tool, follow the steps below.

### Prepare

The file **hyperspectral.img** should be displayed in a Viewer with the **Fit to Frame** checkbox activated.

1. In the Viewer menu bar, select **Raster | Profile Tools**.

The Select Profile Tool dialog opens.

2. In the Select Profile Tool dialog, click the **Surface** button and then click **OK**.

The Surface Profile viewer opens.

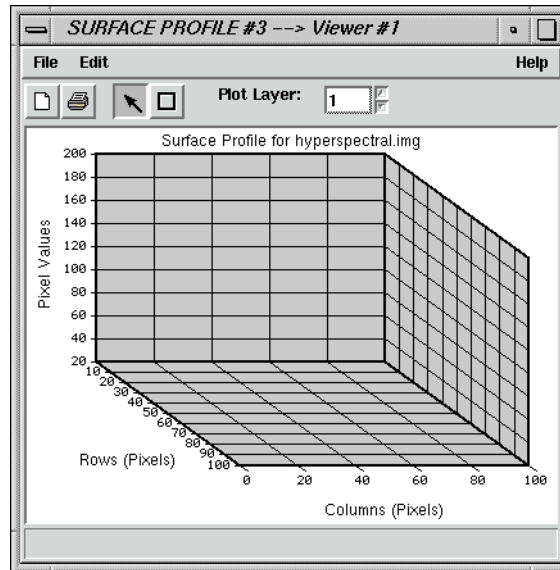

3. Click on the Rectangle icon in the Surface Profile viewer and then select an AOI in the Viewer by dragging to create a box around it.



When the mouse button is released, the surface profile for the selected area is displayed in the Surface Profile viewer. As with all of the profile tools, selecting **Edit | Chart Options** allows you to optimize the display.

### Analyze Data

It may be desirable to overlay a thematic layer onto this surface. For example, a vegetation map could be overlaid onto a DEM surface, or an iron oxide map (Landsat TM3/TM1) onto a kaolinite peak (1.40  $\mu\text{m}$ ) layer. In this example, you overlay a true color image.

1. In the Surface Profile viewer, select **Edit | Overlay True Color**.

The Overlay TrueColor on Surface dialog opens.



## Viewer

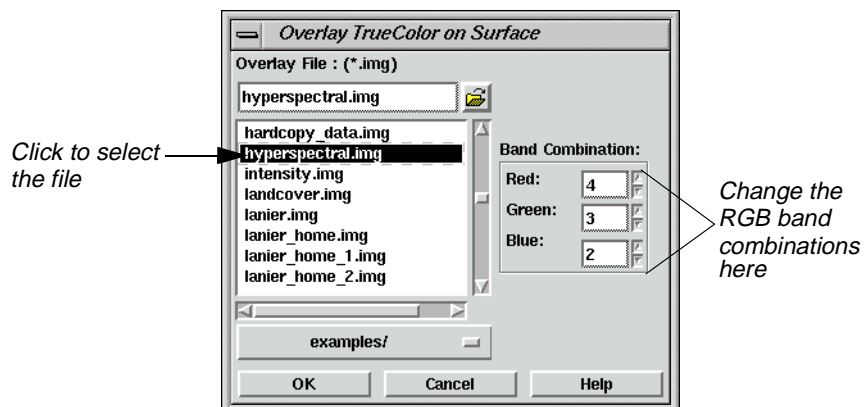

2. In the Overlay TrueColor on Surface dialog, select **hyperspectral.img** under **Overlay File**.
3. Under **Band Combination**, enter **55** for **Red**, **34** for **Green**, and **2** for **Blue**.
4. Click **OK** in the Overlay TrueColor on Surface dialog.
5. When you are finished analyzing the data, select **File | Close** from the Spatial Profile viewer menu bar.



*For more information on Hyperspectral Image Processing or the Hyperspectral Profile Tools, see "CHAPTER 5: Enhancement" in the ERDAS Field Guide.*

## Image Drape

It is possible to access the Image Drape utility either through the **Tools** menu in the ERDAS IMAGINE menu bar or through the Viewer. Here, you access the Image Drape utility via the Viewer.

### Prepare

ERDAS IMAGINE should be running and a Viewer should be open.

1. Click the Open icon in the Viewer tool bar.



The Select Layer To Add dialog opens.

2. In the Select Layer To Add dialog under **Filename**, select the file **eldodem.img**.
3. Click **OK** in the Select Layer To Add dialog.

The file **eldodem.img** displays in the Viewer.

4. Click the Open icon again in the Viewer tool bar.  
The Select Layer To Add dialog reopens.
5. In the Select Layer To Add dialog under **Filename**, select the file **eldoatm.img**.
6. Click the **Raster Options** tab at the top of the dialog.
7. In the Raster Options, click the **Clear Display** checkbox to turn it off. This allows **eldoatm.img** to display on top of **eldodem.img**.
8. Click **OK** in the Select Layer To Add dialog.

Now, both **eldodem.img** and **eldoatm.img** are displayed in the same Viewer, with the **eldoatm.img** layer on top.

9. Select **Utility | Image Drape** from the Viewer menu bar.

An Image Drape viewer displays, with the overlapping images in it.

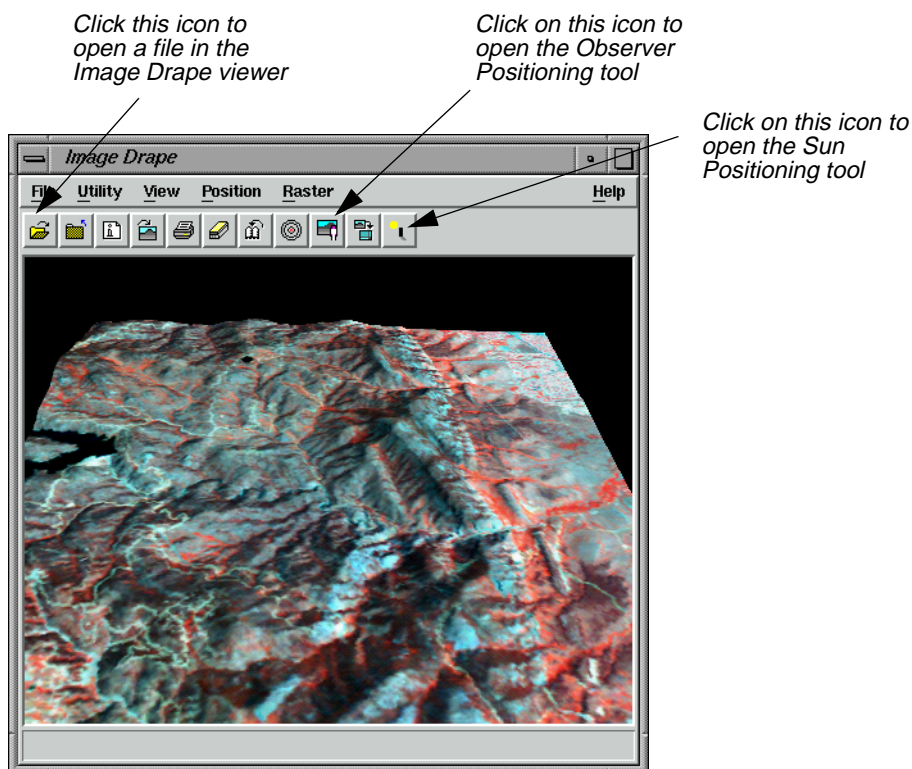

## Change Options

1. Select **Utility | Options** from the Image Drape viewer menu bar.  
The Options dialog opens.

## Viewer

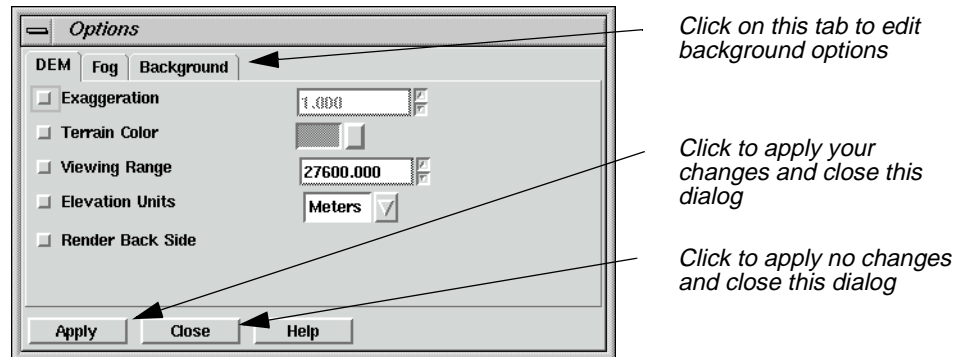

2. Click on the **Background** tab in the Options dialog.
3. In the Background options, hold on the popup list next to **Background Color** and select **Gold**.
4. Click **Apply** in the Options dialog.  
The background of the image in the Image Drape viewer is now gold.
5. Click **Close** in the Options dialog.

## Change Sun Position

1. Select **View | Sun Positioning** from the Image Drape viewer menu bar.  
The Sun Positioning dialog opens.

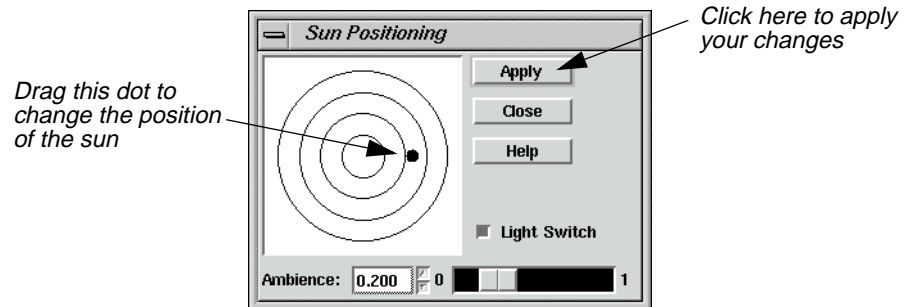

2. In the Sun Positioning dialog, drag the dot to another position on the target. The center of the target indicates the sun position at high noon.
3. Click **Apply** and then **Close** in the Sun Positioning dialog.

Note how the shadows across the image change to reflect the different sun position you have selected.



## Dump Contents to Viewer

1. Select **Utility | Dump Contents to Viewer** from the Image Drape viewer menu bar.

A second Viewer opens, displaying another view of the image in the Image Drape viewer.

2. Select **File | Close** in the first Viewer to clear it from the screen.

3. Select **View | Link/Unlink with Viewer** from the Image Drape viewer menu bar.

An instructions box opens, directing you to click in the Viewer to which you want the Image Drape viewer to be linked.

4. Click in the Viewer you just created.

The viewers are now linked and a Positioning tool displays in the Viewer.

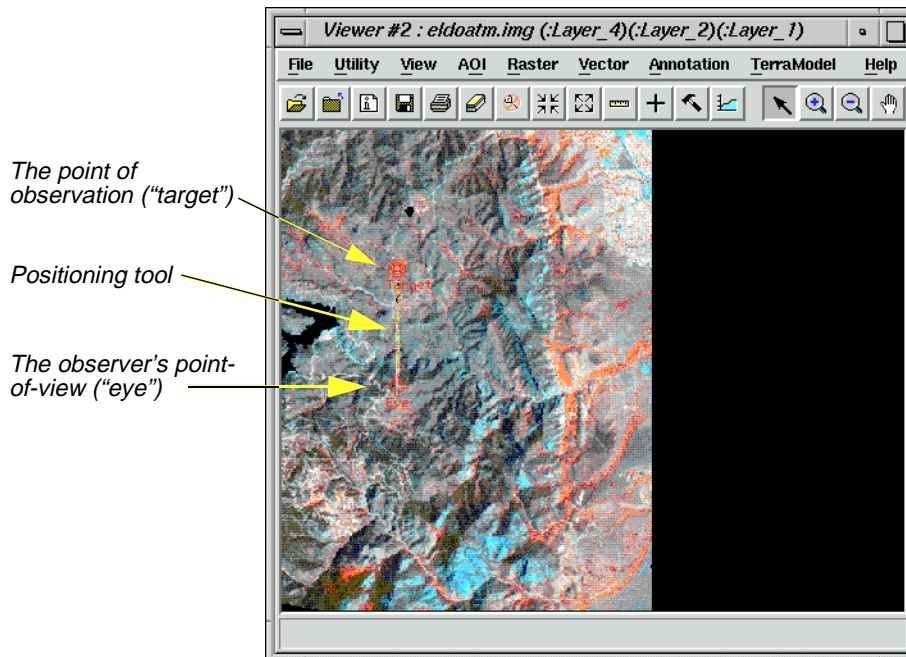

*NOTE: The bounding box in the Viewer image pictured above is for visual purposes only, and does not actually appear in the Viewer window.*

## Start Eye/Target

1. To make the Positioning tool easier to see in the Viewer, select **Utility | Selector Properties** from the Viewer menu bar.

The Eye/Target Edit dialog opens.

# Viewer

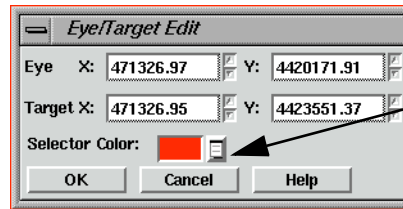

Hold on this popup list to change the selector color

2. In the Eye/Target Edit dialog, hold on the **Selector Color** popup list and select a color that displays well in the Viewer image (e.g., Yellow).
3. Click **OK** in the Eye/Target Edit dialog.

The dialog closes and the color of the Positioning tool is updated to the designated color.

## Manipulate the Observer and Field of View

You can manipulate the observer and the observer's field of view in several ways. See steps (1. through step 3. below to learn how to obtain different views using the Positioning tool and the Position Parameters dialog.

### Use the Positioning Tool

1. Click on the Observer Positioning icon in the Image Drape viewer tool bar.



The Position Parameters dialog opens.

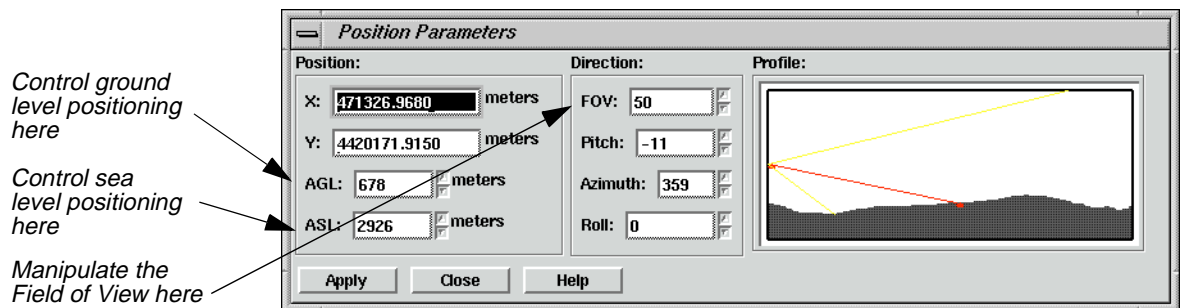

Control ground level positioning here

Control sea level positioning here

Manipulate the Field of View here

2. Drag on the **Eye** marker of the Positioning tool to change the observer's point of view in the Image Drape viewer.

The data in the Position Parameters dialog updates to reflect the changes in the observer's position. The view in the Image Drape viewer is also updated.



---

*If the image in the Image Drape viewer does not completely refresh when the mouse button is released, click the Update icon.*



- Next, drag on the **Target** marker of the Positioning tool to change the point of observation in the Image Drape viewer.

The data in the Position Parameters dialog updates to reflect the changes in the point of observation. The view in the Image Drape viewer is also updated.

- Change the position of both the observer and the target at once by dragging on the line that connects them in the Viewer.

The data in the Position Parameters dialog and the Image Drape viewer is updated.

- In the Image Drape viewer, click the Goto icon to return to the original position of the observer and the target.



The image and the Positioning tool in the Viewer are updated to their original position. The Position Parameters dialog is also updated.

#### Use the Position Parameters Dialog

- In the Position Parameters dialog, change the **FOV** to **90** and the **Roll** to **45**, then click **Apply**.

The image in the Image Drape viewer is updated to reflect this change.

- In the Position Parameters dialog under **Observer Position**, enter **3000** in the **AGL** (Above Ground Level) number field.
- Click **Apply** and then **Close** in the Position Parameters dialog.



---

*For more information about the Viewer, see "APPENDIX A: Additional Information" on page 595.*



# Viewer



# CHAPTER 2

## Image Catalog

---

### Introduction

In this tour guide, you can learn how to:

- set catalog preferences
- create an Image Catalog
- add information to a catalog
- perform queries
- view the information in a catalog
- modify the views/information
- save and restore a specific area of coverage
- archive data
- add custom maps



---

*Approximate completion time for this tour guide is 15 minutes.*

---

### Set Catalog Preferences

#### Prepare

ERDAS IMAGINE should be running. It is not necessary to have a Viewer open.

1. In the ERDAS IMAGINE menu bar, select **Session | Preferences**.

The Preference Editor opens.

2. In the Preference Editor under the **Category** list, select **Image Catalog**.

The default preferences for the Image Catalog display.

The following table lists and describes the various catalog preferences.

**Table 2-1: Image Catalog Preferences**

Preference	Function
Catalog Directory	The default directory that the catalog uses to save and open catalogs.
Default Catalog	The name of the catalog that is opened by default when the Image Catalog starts.
Canvas Backdrop	The backdrop file (ArcInfo coverage) that is displayed when the Graphical Query viewer is initially displayed. This must be one of the files named in catalog.cov.
Archive Media	The name of the default media used by the archive function of the catalog.



**Table 2-1: Image Catalog Preferences (Continued)**

Water Color	The default color used for all of the area outside of the polygons in a coverage, which is assumed to be water.
Land Color	The default color used to fill the polygons in an area coverage.
Border Color	The default color used to draw the border around each of the polygons in an area coverage.
Line Style	The default style used for lines in a line coverage.
Point Symbol	The default symbol used for points in a point coverage.
Symbol Color	The default color used for point symbols in a point coverage.
Symbol Size	The default size of point symbols (in points) in a point coverage.
Footprint Color	The default color used for image footprints.
Footprint Selected Color	The default color used for selected image footprints.
Footprint Fill Style	The default style used to fill image footprints.
Show Map Grid	Used to control the display of the map grid at startup.
Grid Color	The default color used for the Lat/Lon grid.
Show Grid Labels	Used to control the display of the text grid labels.
Grid Label Color	The default color used for the map grid text labels.
Level of Detail	Maximum level of detail to use when displaying maps (e.g., local, global).
Show Map Outlines	Enable to display the map outlines at startup.
Map Outline Color	The default color used to display the map outlines.
Map Outline Style	The default line style used for the map outlines (e.g., solid, dashed).
Restore Directory	The default destination directory for restoring an image.

3. Make any changes you wish to the catalog preferences by entering the new information in the fields and pressing Return on your keyboard.
4. To save your changes and accept them as the new defaults, click **User Save**.
5. Click **Close** on the Preference Editor dialog to close the Preference Editor.

## Create an Image Catalog

### Prepare

ERDAS IMAGINE should be running.

1. Click the Catalog icon in the ERDAS IMAGINE icon panel.



The default Image Catalog opens.

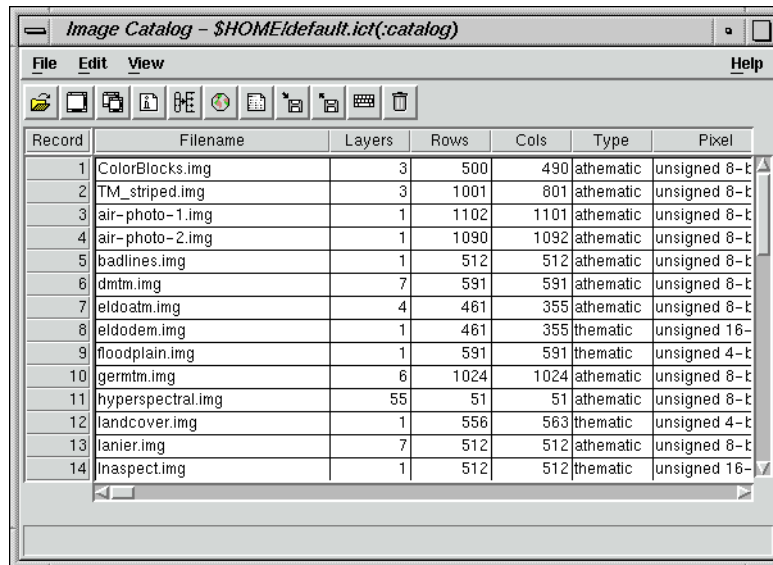

*NOTE: You can specify a default catalog via **Session | Preferences** in the ERDAS IMAGINE menu. More information on how to do this is located in the “Set Catalog Preferences” section of this tour guide.*

For the following example, however, use the default catalog which is distributed with ERDAS IMAGINE.

## Add Information

1. Select **Edit | Catalog Image** or click on the Add Image icon in the Image Catalog tool bar.



The Catalog Image dialog opens.

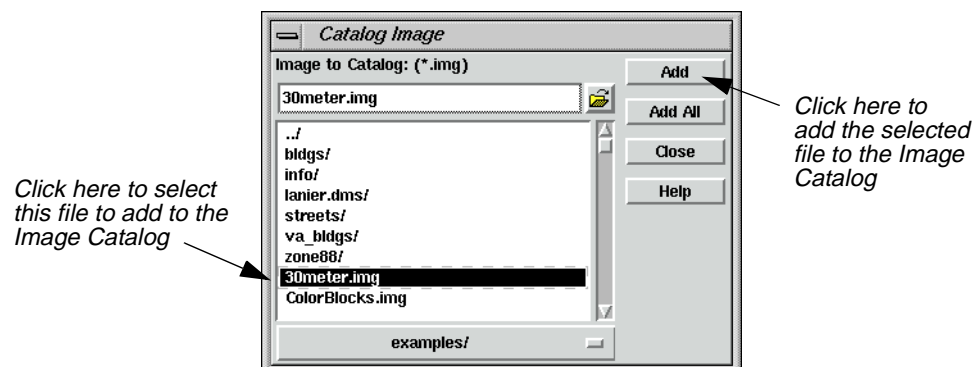

2. In the Catalog Image dialog file list, select **30meter.img**.

# Image Catalog

3. Click **Add**, and then **Close** in the Catalog Image dialog.

**30meter.img** is recorded in the Image Catalog.

*NOTE: If you were to select **30meter.img** and then select **Add All**, all files with an .img extension would be added to the Image Catalog.*

---

## Perform Graphical Queries

### Prepare

The Image Catalog should be open and it should contain the images in the <IMAGINE\_HOME>/examples directory.

1. Select **View | Graphical Query Viewer** or click the Visual Query icon in the Image Catalog tool bar.



The Graphical Query viewer opens.

## Select Area

First, select an area of the map in which you want to query the images, and then you run the query.

1. Click the Select Area for Zooming icon in the Graphical Query viewer tool bar.



The pointer becomes a crosshair.

2. With the crosshair, draw a bounding box that covers the entire continental United States.

When the mouse button is released, the United States is magnified in the Graphical Query viewer. Note that more detail is presented as the backdrop is zoomed.



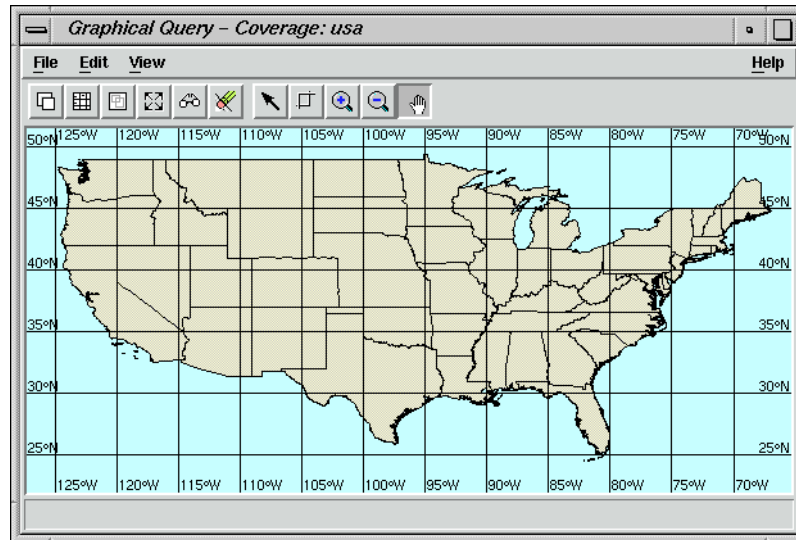

## Run Query

1. Click the Query icon in the Graphical Query viewer tool bar.



The files of images located within the designated query area (the continental US) are highlighted in yellow in the Image Catalog. Tiny rectangles on the map in the Graphical Query viewer mark the location of these images.

Record	Filename	Layers	Rows	Cols	Type	Pixel
1	ColorBlocks.img	3	500	490	athematic	unsigned 8-t
2	TM_striped.img	3	1001	801	athematic	unsigned 8-t
3	air-photo-1.img	1	1102	1101	athematic	unsigned 8-t
4	air-photo-2.img	1	1090	1092	athematic	unsigned 8-t
5	badlines.img	1	512	512	athematic	unsigned 8-t
6	dmtm.img	7	591	591	athematic	unsigned 8-t
7	eldoatm.img	4	461	355	athematic	unsigned 8-t
8	eldodem.img	1	461	355	thematic	unsigned 16-
9	floodplain.img	1	591	591	thematic	unsigned 4-t
10	germtm.img	6	1024	1024	athematic	unsigned 8-t
11	hyperspectral.img	55	51	51	athematic	unsigned 8-t
12	landcover.img	1	556	563	thematic	unsigned 4-t
13	lanier.img	7	512	512	athematic	unsigned 8-t
14	inaspect.img	1	512	512	thematic	unsigned 16-



## Image Catalog

2. Click the Zoom In icon in the Graphical Query viewer tool bar.



3. Place the Zoom In tool over one of the black dots in the map in the Graphical Query viewer and click until the dot is magnified to a yellow box.
4. Click the Select icon in the Graphical Query viewer tool bar.



5. With the Select tool, click on the yellow box you just magnified. Note that all of the other images located in the Graphical Query viewer are characterized by red boxes.

The corresponding filename is highlighted in the Image Catalog.

6. Click the Display Single icon in the Image Catalog tool bar.



The selected image displays in a Viewer.

7. Repeat steps (2. through (6., selecting a red box on the map to display another image. Note that when the box is selected, it turns yellow.

If necessary, click the Roam icon in the Graphical Query viewer tool bar, and then drag the image in the Graphical Query viewer to manipulate the image view. (If you reset the display, be prepared to start back at step 1. in "Select Area")



*NOTE: Magnified boxes that are deselected are red in color; selected boxes are yellow.*

8. In the Image Catalog tool bar, click the Display Another icon to display the image you selected in step 7. in a second Viewer.



### View Information

1. To view all of the information for the image in your first Viewer in one convenient form, highlight that file in the Image Catalog by clicking on the **Record** number of that file.

The file is highlighted in yellow.

2. In the Image Catalog dialog, select **View | Form View** or click the Catalog Default icon.



The Form View dialog opens, listing the characteristics of the file you selected.

3. In the bottom left corner of the Form View dialog, there are up and down arrows. Click twice on the down arrow, noting that the information in the Form View dialog corresponds with the highlighted file in the Image Catalog.
4. Click **Close** to close the Form View dialog.
5. Another way to view information on individual files is to use the ImageInfo dialog. Select **View | Image Info** from the Image Catalog or click the Info icon.



The ImageInfo dialog opens.

6. Select **File | Close** from the ImageInfo dialog.

### Modify Views

1. In the Graphical Query viewer, select **File | Area Definition**.

The Area Definition dialog opens.

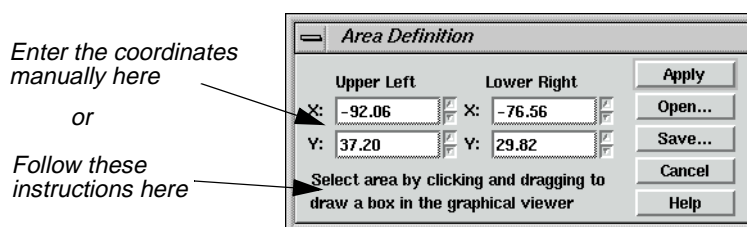

The Area Definition dialog lets you store the extent of particular areas of interest for quick retrieval. For example, if your study area covers the states of North and South Dakota, you could save a view of just that area. You can either enter the coordinates manually into the Area Definition dialog, or you can select an area by drawing a box in the Graphical Query viewer.

The upper left and lower right coordinates are the coordinates of the area currently viewed in the Graphical Query viewer. You can save these coordinates to a bounding box file (.bbox).

2. Click **Save** in the Area Definition dialog.

The Defined Areas dialog opens.

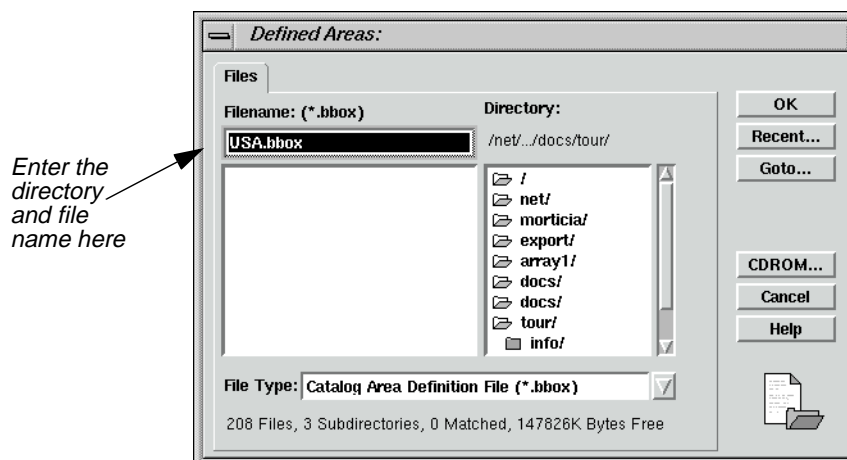

3. In the Defined Areas dialog under **Filename**, enter the name **USA** in the directory of your choice and then click **OK**.
4. Click **Cancel** in the Area Definition dialog to close it.
5. In the Graphical Query viewer, click the Roam icon and then drag on the image to view a different area.
6. In order to recall the view you saved as **USA.bbox**, select **File | Area Definition** in the Graphical Query viewer, and then click **Open** in the Area Definition dialog.

The Defined Areas dialog opens.

7. In the Defined Areas dialog under **Filename**, click on **USA.bbox**.

- Click **OK** in the Defined Areas dialog.

The Defined Areas dialog closes and the coordinates in the Area Definition dialog change.

- Click **Apply** and then **Cancel** in the Area Definition dialog.

The Graphical Query viewer redisplay the view you saved as **USA.bbox**.

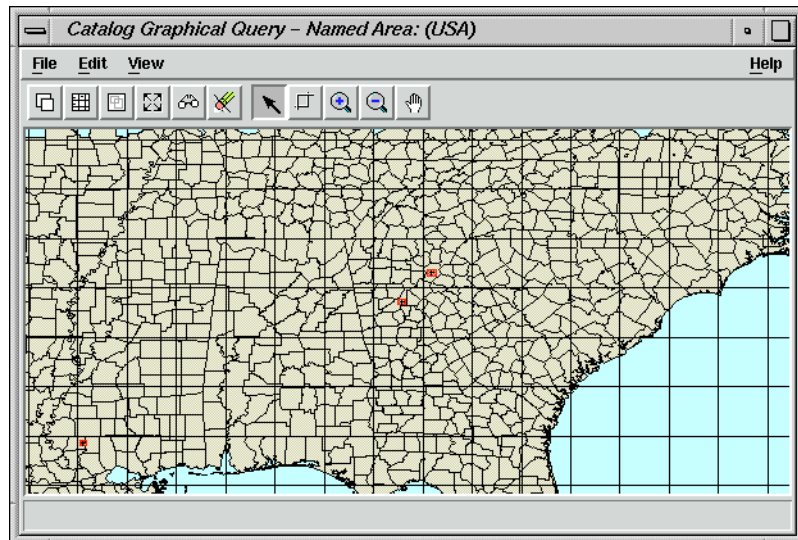

## Archive Data

The following steps detail how data are archived.



*You must have a non-rewinding tape device already configured in order to archive data.*

- Select the image in the Viewer by clicking on its **Record** number in the Image Catalog.  
The file is highlighted in yellow.
- In the Image Catalog, select **File | Archive**, or click on the Archive icon in the tool bar.



The Archive dialog opens.



# Image Catalog

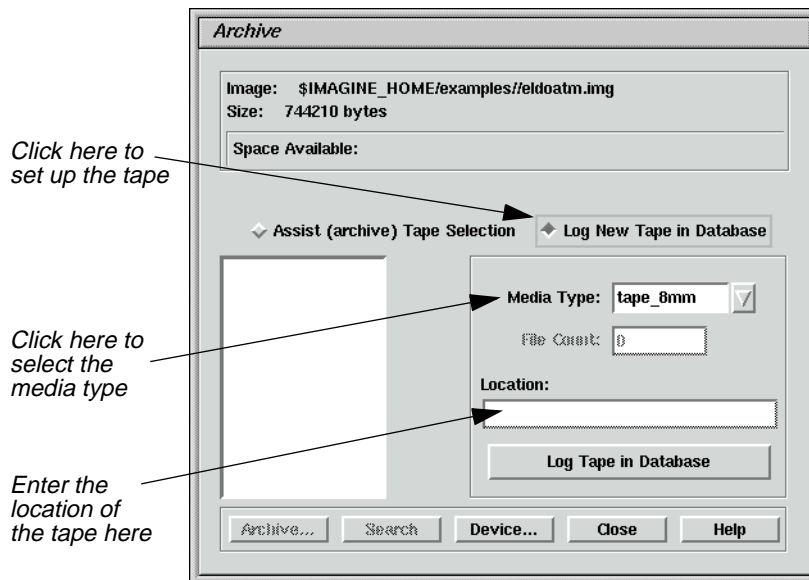

Follow steps (3. through (6. for initial setup only.

3. In the Archive dialog, click **Log New Tape in Database** to set up the tape to be used.
4. Click on the **Media Type** popup list and select either **tape\_8mm** or **tape\_exabyte**.
5. Enter the **Location** of the tape. This is simply a note to yourself, indicating where you store the tape or which tape you are using (e.g., top shelf or tape #16).
6. Click **Log Tape in Database** to add this tape to the list of available tapes. A message displays with the identification number that should be placed on the tape for later retrieval. The new tape number is displayed in the scrolling list of available tapes.
7. Click the tape from the list.
8. Click **Device** to select the actual tape device to which you archive. A list of configured tape devices displays.
9. In the Select Configured Devices dialog, click the device to which you archive. It must be configured as a non-rewinding device.
10. Click **Select** to select the device.
11. In the Archive dialog, click **Archive** to archive the selected image.
12. You are instructed to place the selected tape in the selected device. Click **Continue** when the tape is loaded.

You are informed when the process is complete.

*NOTE: For subsequent images, omit steps (3. through (6.*





---

*For more information about the Image Catalog, see "APPENDIX A: Additional Information" on page 595.*



# Image Catalog





# CHAPTER 3

## Map Composer

---

### Introduction

The ERDAS IMAGINE Map Composer is an editor for creating cartographic-quality maps and presentation graphics. Maps can include single or multiple continuous raster layers, thematic (GIS) layers, vector layers, and annotation layers.

Map Composer's extensive annotation capabilities allow you to automatically generate text, legends, scale bars, grid lines, tick marks, borders, symbols, and more. You can select from over 16 million colors, multiple line styles, and over 60 text fonts.



---

*Approximate completion time for this tour guide is 40 minutes.*

---

### Create a Map

In this tutorial, you create a map using the file **modeler\_output.img** in the `<IMAGINE_HOME>/examples` directory. This file contains SPOT panchromatic data overlaid with an environmental sensitivity analysis file.

In creating this map, you use these basic steps:

- plan the map
- start Map Composer
- prepare the data layers
- draw the map frame
- add a neatline and tick marks
- make scale bars
- create a legend
- add a map title
- place a north arrow
- write descriptive text
- print the map

This tour guide also contains information about editing map frames, deleting map frames, and editing map compositions.



# Map Composer

## Start Map Composer Prepare

You must have ERDAS IMAGINE running.

1. Start Map Composer by clicking the Composer icon on the ERDAS IMAGINE icon panel.

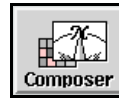

The **Map Composer** menu displays.

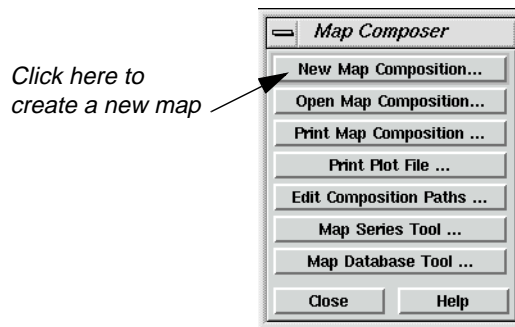

2. In the **Map Composer** menu, select **New Map Composition** to create a new map composition.



You can also create a new composition by selecting **File | New | Composition** from the Viewer menu bar.

The New Map Composition dialog opens.

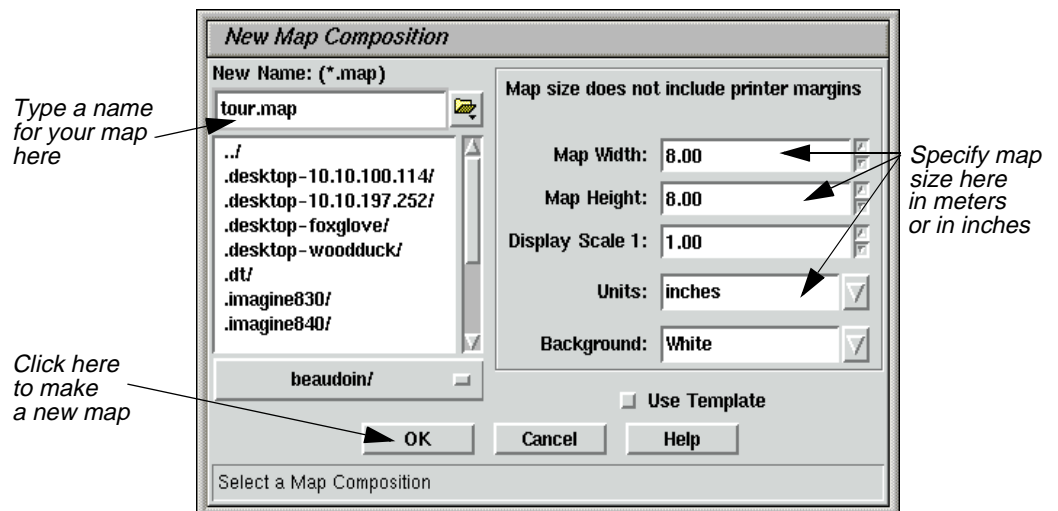

3. In the New Map Composition dialog under **New Name**, type a unique name for your map (such as **tour.map**). Be sure that you have write permission in the directory where you are creating the new map.
4. Drag across the value in **Map Width** to select it.
5. Type **7.5** and then press the Return key on your keyboard.
6. Drag across the value in **Map Height** to select it.
7. Type **10.0** and then press the Return key on your keyboard.

Most printers have a small margin on all sides of a sheet that are unprintable. Therefore, even though you output your map to 8.5" × 11.0" paper, you must specify a smaller size here for the actual live area of the map. This ensures that no part of the map occupies that unprintable area, and it leaves a margin around the edge of the composition.

8. Accept the **Display Scale 1** of **1.00** and **inches** for the **Units**.
9. Click **OK** in the New Map Composition dialog.

A blank Map Composer viewer displays along with the Annotation tool palette.

*NOTE: The tool palette that displays on your screen may look different from the following one, depending upon your ERDAS IMAGINE preferences.*

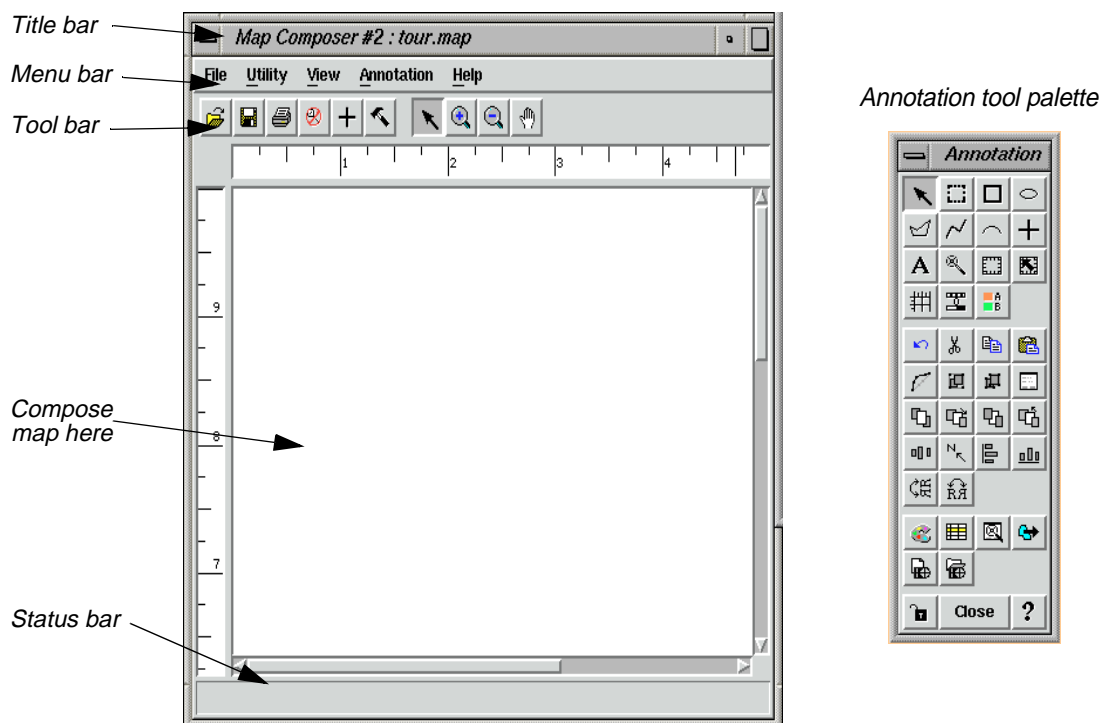

10. With your cursor in the Map Composer viewer, right-hold **Fit Map To Window** from the **Quick View** menu so that you can see the entire map composition page.

# Map Composer

## Prepare the Data Layers

You must determine what data layer(s) you are going to use in your composition and then display the layer(s) in a Viewer window. In this exercise, you use **modeler\_output.img** from the <IMAGINE\_HOME>/examples directory.

### Prepare

ERDAS IMAGINE must be running, and you must have a Viewer and a Map Composer viewer open.

1. In the Viewer, click the Open icon on the tool bar or select **File | Open | Raster Layer** from the menu bar.



The Select Layer To Add dialog opens.

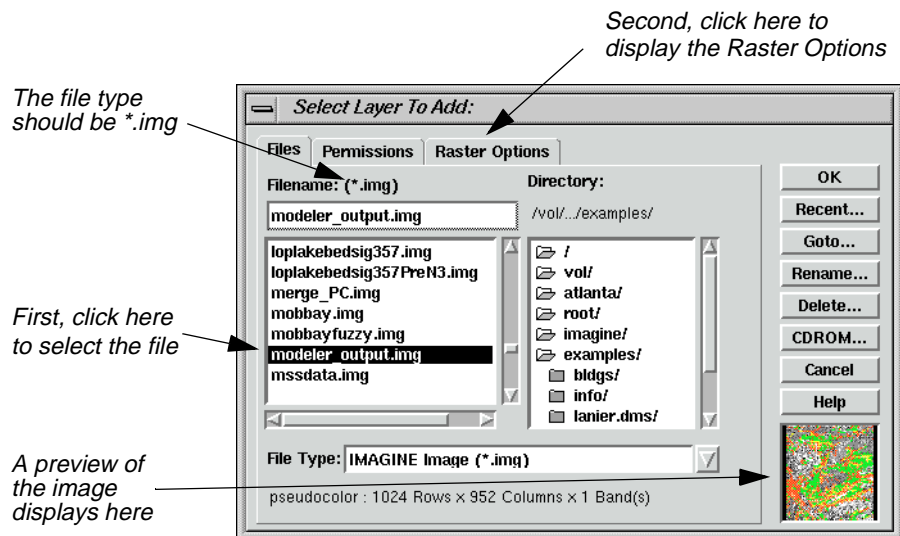

2. In the Select Layer To Add dialog under **Filename**, click on **modeler\_output.img**. Be sure that the source directory is <IMAGINE\_HOME>/examples> (the default).
3. Click on the **Raster Options** tab and then select the **Fit to Frame** option so that you can see the entire file and can more easily select the area to include in the map.
4. Click **OK** in the Select Layer To Add dialog.

## Draw the Map Frame

You can now begin creating your map composition. The first step in creating your map is to define the map frame.



### What is a Map Frame?

A map frame is drawn, resized, and selected like other annotation elements, but a map frame works like a Viewer. Map frames can contain raster, vector, and annotation layers that you want to include in your composition.

Although map frames display the layer(s) you want to include in a map composition, the data in a map frame are not copied, but are referenced. When you create a map frame, simply click in the Viewer where the layers you want to use in the map are displayed.

### Map Frame Dimensions

There are three ways to select the dimensions of a map frame. You use different options depending on the image area you want in the final map composition. The dimensions of a map frame are expressed in the following ways:

- The map area is the area in the Viewer that is displayed in the map frame in the map composition. It corresponds to the dimensions of the area on the ground in map units.
- The frame area is the area used by the map frame in the map composition. It is the area on the page occupied by a particular image. It is defined in page units.
- The scale (like the scale used in geometric correction) is the ratio of distance in the map frame to the distance that is represented on the ground. For example, you can define an area showing a scale of 1:24,000.

### Prepare

A Viewer must be open, with the data layer you want to use in your composition displayed in it. You must also have an open Map Composer viewer.

1. From the Annotation tool palette, click the Map Frame icon to draw the boundary of the map frame.



2. Near the top of the Map Composer viewer, Shift-drag your cursor downward at an angle to draw the map frame. You position and size the map frame later.

*NOTE: Pressing the Shift key while drawing the map frame allows you to draw a perfect square.*

When the mouse is released, the Map Frame Data Source dialog opens.

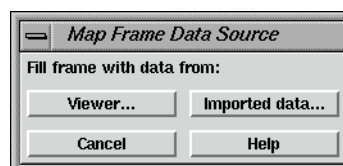

# Map Composer

3. In the Map Frame Data Source dialog, click the **Viewer** button to select the source image from the Viewer.

The Create Frame Instructions dialog displays.

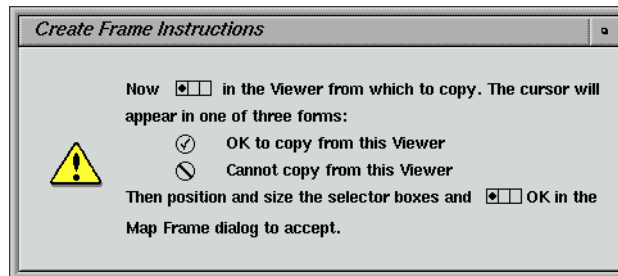

4. Click anywhere in the image in the Viewer to reference the displayed image to the new map frame.

The Map Frame dialog opens, giving you options for sizing, scaling, and positioning the map frame.

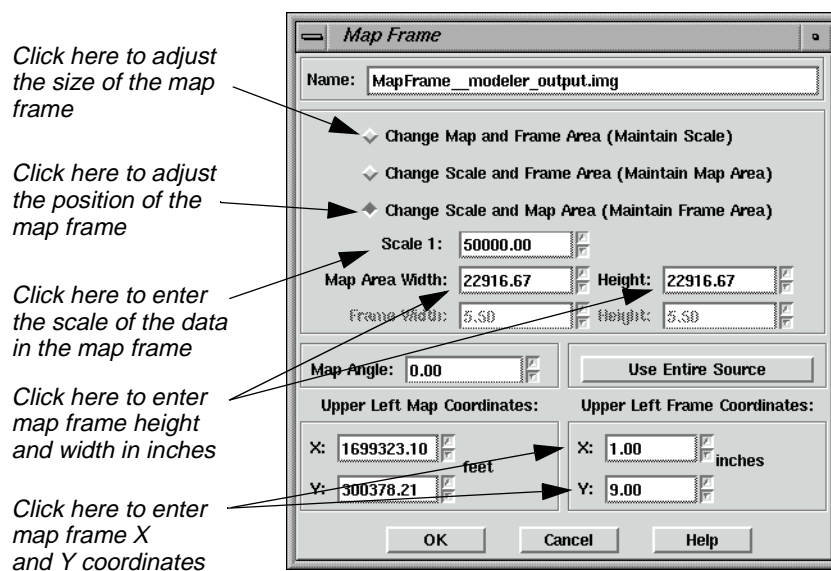

A cursor box also displays in the Viewer. This cursor box allows you to select the area you want to use in the map composition.

### Adjust the Size of the Map Frame

You can move the map frame in the Map Composer viewer window and the cursor box in the Viewer by dragging and resizing them with the mouse, or you can move one or both boxes by manipulating the information in the Map Frame dialog. You can also rotate the box in the Viewer if you want to change the orientation.

Next, you move the map frame by setting parameters in the Map Frame dialog. Then you can select the image area you like by using the mouse to move the cursor box in the Viewer.

The three buttons at the top of the Map Frame dialog allow you to adjust two parameters while keeping the other frozen. Start by selecting the size of the map frame (**Change Scale and Frame Area**), and then freeze that option to select the scale and position of the map frame (**Change Scale and Map Area**).

Your map frame is positioned according to the following illustration:

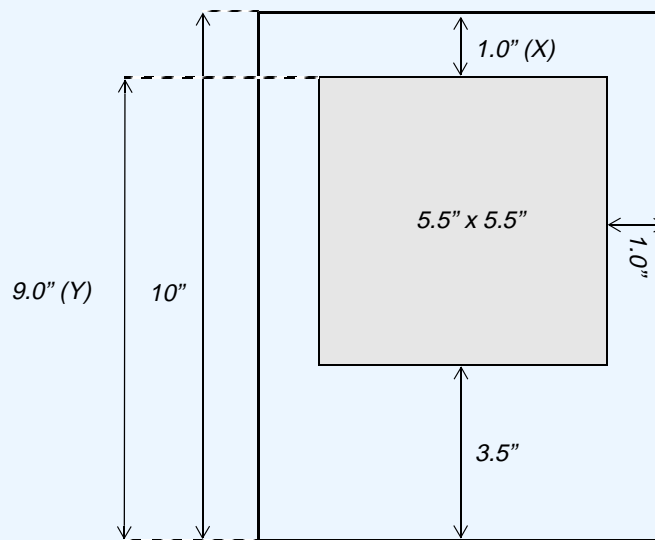

*The origin of the Map Composer viewer is the lower left corner.*

1. In the Map Frame dialog, click the **Change Map and Frame Area (Maintain Scale)** option so that you can accurately size the map frame in the Map Composer viewer window.
2. In the Map Frame dialog, double-click on the value in **Frame Width** to select it.
3. Type **5.5** for the width of the map frame and then press the Return key on your keyboard.
4. Double-click on the value in the frame **Height** (to the right of **Frame Width**) to select it.
5. Type **5.5** for the height of the map frame and then press the Return key on your keyboard.



# Map Composer

## Adjust the Position of the Map Frame

1. In the Map Frame dialog, click the **Change Scale and Map Area (Maintain Frame Area)** option so that you can select a map area in the Viewer without losing the dimensions of the map frame in the Map Composer viewer.
2. In the Map Frame dialog, under **Upper Left Frame Coordinates**, change the **Y** value to **9.0**. Press Return on your keyboard.
3. Double-click on the value in **Scale 1** to select it.
4. Type **50000**. Press Return on your keyboard.
5. With your cursor inside the cursor box in the Viewer, drag the cursor box to the area you want to display in the map composition.
6. When the cursor box is positioned to your satisfaction, click **OK** in the Map Frame dialog to reference that portion of the image to the map composition.

The image area that you selected in the Viewer is now displayed in the map frame in the Map Composer viewer.

7. To enlarge the image in the Map Composer viewer, drag on the corners of the Map Composer viewer to enlarge it, and the right-hold to select **Fit Map To Window** from the **Quick View** menu.





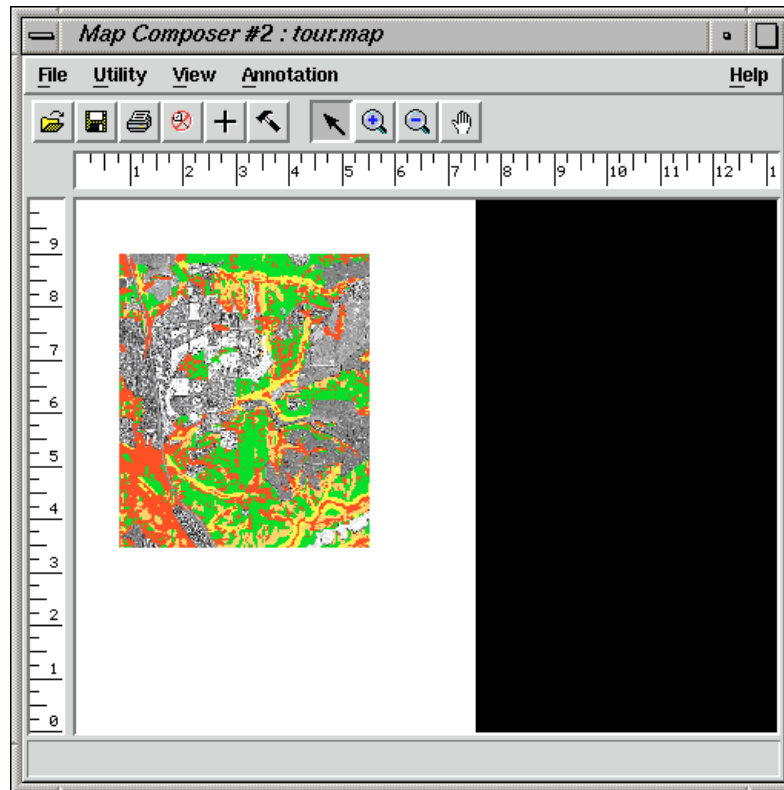

8. You are now finished with the Viewer, so select **File | Close** from the Viewer menu bar to close it.

### Choose Your Path

- If you are satisfied with your map frame and the image area you have selected, proceed to Add a Neatline and Tick Marks on page 83.
- If you want to edit your map frame or change the image area you selected, proceed to “Edit the Map Frame”.

---

## Edit the Map Frame

The Map Composer is very flexible in allowing you to place a map frame in a composition based on scale, image area, etc. Once you have placed a map frame in a composition, you can move it, change the size of it, and change the image area within it.



*If you want to change the image you are using, you must delete the map frame and redraw it or edit the .map file.*

### Choose Your Path

- To edit the map frame, proceed with this section.
- To delete the map frame, proceed to Delete the Map Frame on page 82.
- To edit the .map file, proceed to Edit Composition Paths on page 97.



# Map Composer

1. To edit a map frame, click the Select Map Frame icon in the Annotation tool palette.



2. Click in the map frame you want to edit to select it.
3. In the Map Composer viewer, select **Annotation | Element Properties** or double-click in the map frame.

A new Viewer opens, with the image you are using displayed. A white cursor box indicates the area currently in the map frame. The Map Frame dialog also opens, displaying the settings you originally entered to position and size the map frame.

4. Change the information in the Map Frame dialog and/or move the cursor box in the Viewer.
5. Click **OK** in the Map Frame dialog when you are satisfied with the map frame.
6. Select **File | Close** from the Viewer menu bar.

## Delete the Map Frame

If you want to delete the map frame altogether, follow the next series of steps.



*Deleting a map frame cannot be undone.*

### Prepare

You must have your map composition open.

1. In the Map Composer viewer menu bar, select **View | Arrange Layers**.

The Arrange Layers dialog opens.

*Press the third mouse button to delete this map frame*

*Click here to delete the map frame*

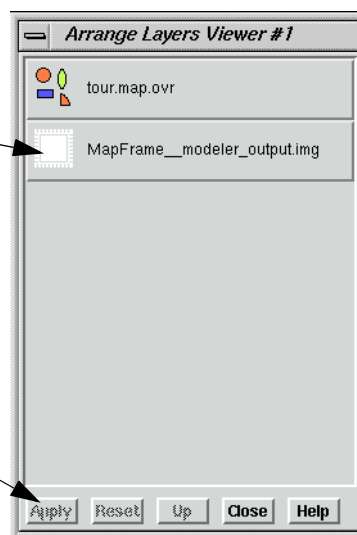

2. In the Arrange Layers dialog, move your pointer to the box titled **MapFrame\_\_modeler\_output.img** and right-hold to select **Delete Layer** from the Frame Options popup list.
3. In the Arrange Layers dialog, click **Apply** to delete the map frame.
4. Click **Close** in the Arrange Layers dialog.

You are now ready to redraw the map frame. Return to Draw the Map Frame on page 76.

---

### Add a Neatline and Tick Marks

Now, add a neatline and labeled tick marks around the image in the map composition.

#### Neatlines and Tick Marks

- A neatline is a rectangular border around a map frame.
- Tick marks are small lines along the edge of the map frame or neatline that indicate regular intervals of distance. Tick marks are usually labeled in meters, feet, or other units.

The Map Composer allows you to generate a neatline and labeled tick marks at the same time. A set of these elements for a map frame is actually a group of line and text elements that is automatically generated to your specifications. (You can also generate grid lines in the same step, but grid lines are not included in this map.)

#### Prepare

You must have a Map Composer viewer open containing a map frame referenced to a georeferenced image in order to generate georeferenced tick marks. The Annotation tool palette must also be open.

1. If you have not already done so, right-hold **Fit Map To Window** in the Map Composer viewer so that you can see the entire map composition page.
2. Click the Grid/Tick icon on the Annotation tool palette.



3. Click on the image inside the map frame on which you want to place the neatline and tick marks.

The Set Grid/Tick Info dialog opens.



# Map Composer

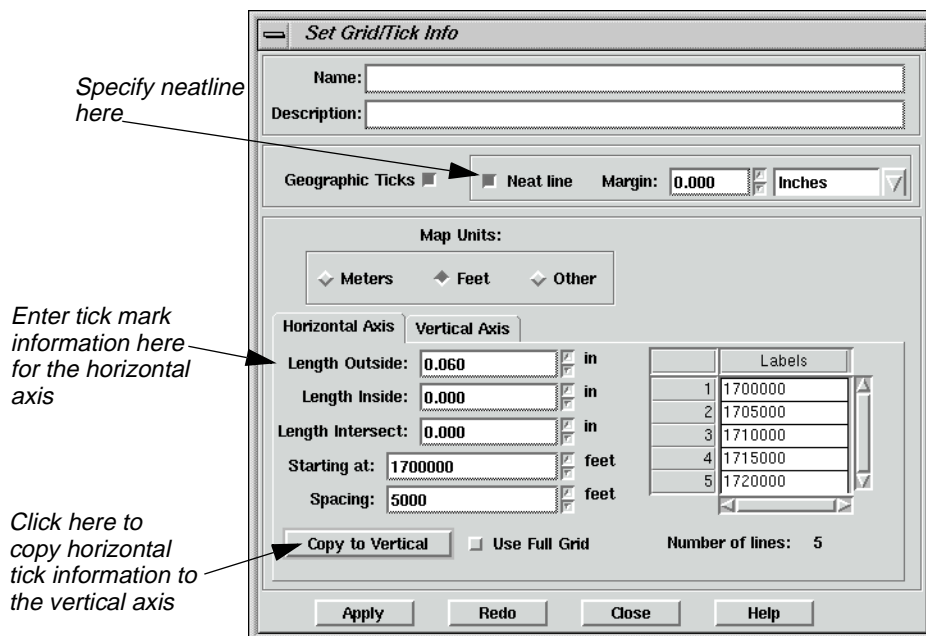

4. Accept the default of **Neat line** to put a neatline around the map and leave the **Margin** at **0** so that the neatline fits to the edge of the map frame.
5. In the **Horizontal Axis** options, drag across the **Length Outside** field to select it.
6. Type a tick length of **0.06**. Press Return on your keyboard.  
Tick marks extend 0.06" outside of the map frame.
7. Drag across the **Spacing** field to select it.
8. Type **5000**. Press Return on your keyboard.  
The **Number of lines** is about **4**, indicating that there are 4 horizontal tick marks (depending on the actual image area you selected).
9. Click the **Copy to Vertical** option to apply these settings to the vertical axis.  
The same settings are applied to the vertical axis.
10. Click the **Vertical Axis** tab to verify neatline and label information for the vertical axis.
11. Click **Apply** in the Set Grid/Tick Info dialog to place the neatline and tick marks on the map.
12. If you are satisfied with the appearance of the neatline, click **Close** in the Set Grid/Tick Info dialog. Otherwise, you may make adjustments in the Set Grid/Tick Info dialog and click **Redo** to apply them. Your map should look similar to the following:

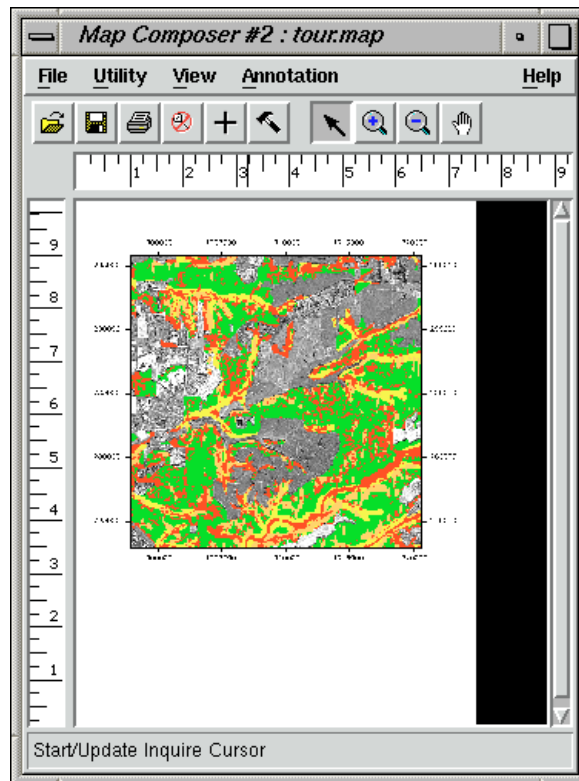

### Change Text/Line Styles

The text and line styles used for neatlines, tick marks, and grid lines depend on the default settings in the Styles dialog. You can either set the styles before adding this annotation to your map, or you can change the styles once they are placed in the map.

Next, set the line style to 1 point for the neatline and tick marks, and the text size to 10 points for the tick labels.

1. Select the group of ticks, tick labels, and the neatline by clicking on any of the number labels outside of the map frame.

A selection box displays around the entire group.

2. From the Map Composer viewer menu bar, select **Annotation | Styles**.

The Styles dialog opens.

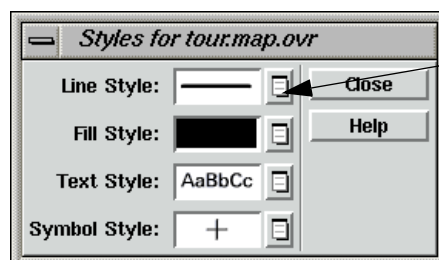

*Hold on this popup list to select Other*



# Map Composer

3. In the Styles dialog, hold on the popup list next to **Line Style** and select **Other**.

The Line Style Chooser dialog opens.

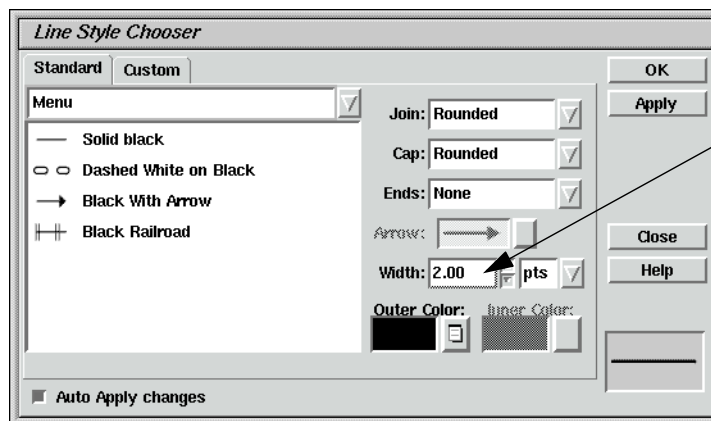

4. In the Line Style Chooser dialog next to **Width**, enter **1.00** to change the width in points.
5. Click **Apply** and then **Close** in the Line Style Chooser dialog.

The group redraws with the new line width.

6. In the Styles dialog, hold on the popup list next to **Text Style** and select **Other**.

The Text Style Chooser dialog opens.

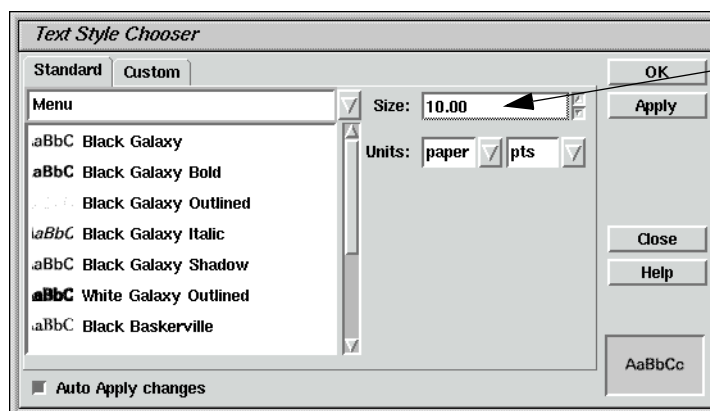

7. In the Text Style Chooser dialog, verify that the **Size** is **10.00**.
8. Click **Apply** and then **Close** in the Text Style Chooser dialog.
9. Deselect this annotation group by clicking anywhere in the map composition window outside of the selection box.
10. Click **Close** in the Styles dialog.

### Make Scale Bars

A scale bar indicates the scale of the image on the map. You can create one scale bar, or several, showing the scale in different units. A scale bar is actually a group of elements that is automatically generated to your specifications.

In this section, place two scale bars in your map composition, showing scale in kilometers and miles. Then center them under the map frame.



*You can create scale bars only for map frames containing georeferenced data.*

#### Prepare

You must have a map composition open and it must contain georeferenced data. The Annotation tool palette must also be open.

1. To place scale bars, select the Scale Bar tool from the Annotation tool palette.



2. Move the cursor into the Map Composer viewer and the cursor changes to the scale bar positioning cursor.
3. Drag the mouse to draw a box under the right corner of the map frame in the Map Composer viewer, outlining the length and location of the scale bar(s).

You can change the size (length) and location later, if needed.

When you release the mouse button, the Scale Bar Instructions dialog is activated.

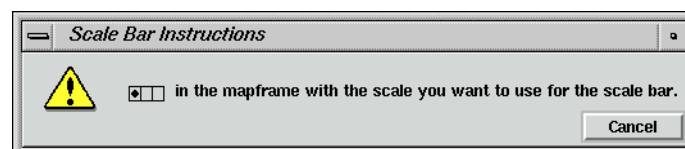

4. Follow the instructions in the Scale Bar Instructions dialog by clicking in the map frame to indicate that this is the image's scale you are showing.

The Scale Bar Properties dialog opens.



# Map Composer

Click here  
and here  
to select units

Click here to  
center scale bars  
on each other

Select length of  
scale bars here

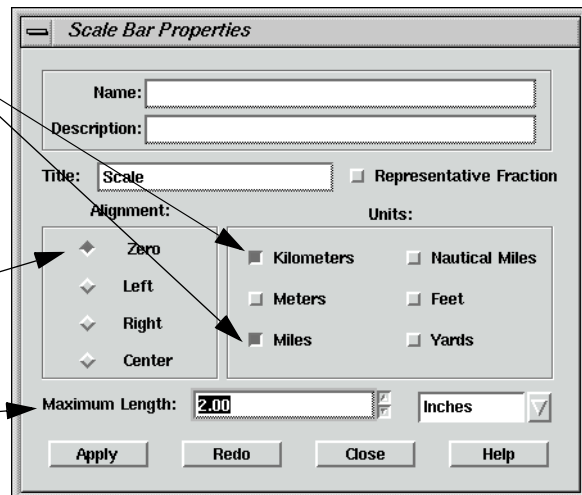

5. In the Scale Bar Properties dialog under **Units**, select **Kilometers** and **Miles** by clicking the appropriate checkboxes.
6. Set the **Maximum Length** to **2.0** inches. Press Return on your keyboard.
7. Click **Apply** in the Scale Bar Properties dialog.

The scale bars display where you drew the box in the Map Composer viewer.

8. If you are satisfied with the appearance of the scale bar, click **Close** in the Scale Bar Properties dialog. Otherwise, you may make adjustments in the Scale Bar Properties dialog and click **Redo** to apply them.

## Reposition Scale Bars

1. If you need to move the scale bars, first select them by clicking on one of the scale bars. To move, simply drag the selection box to the desired position. Remember to click outside the selection box to deselect the scale bars.

---

## Create a Legend

A legend is a key to the colors that are used in a map. Legends created in the Map Composer are actually groups of elements that are generated automatically to your specifications.

Next, you create a legend explaining the four colors used in the overlaid environmental sensitivity analysis.

### Prepare

You must have a map composition open that contains thematic data. The Annotation tool palette should also be open.

1. Click on the Legend icon in the Annotation tool palette.





2. Move the cursor into the Map Composer viewer and the cursor changes to the legend positioning cursor.
3. Click in the Map Composer viewer under the left side of the map frame to indicate the position of the upper left corner of the legend.
4. Click in the map frame to indicate that this is the image you want to use to create the legend. You are reminded to do this with the following dialog:

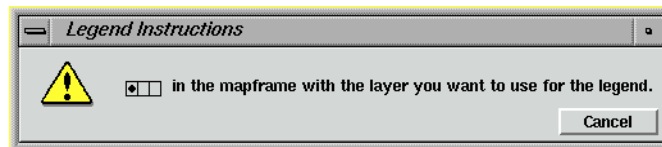

The Legend Properties dialog opens, with the **Basic** properties displayed. The class names are listed under **Legend Layout**.

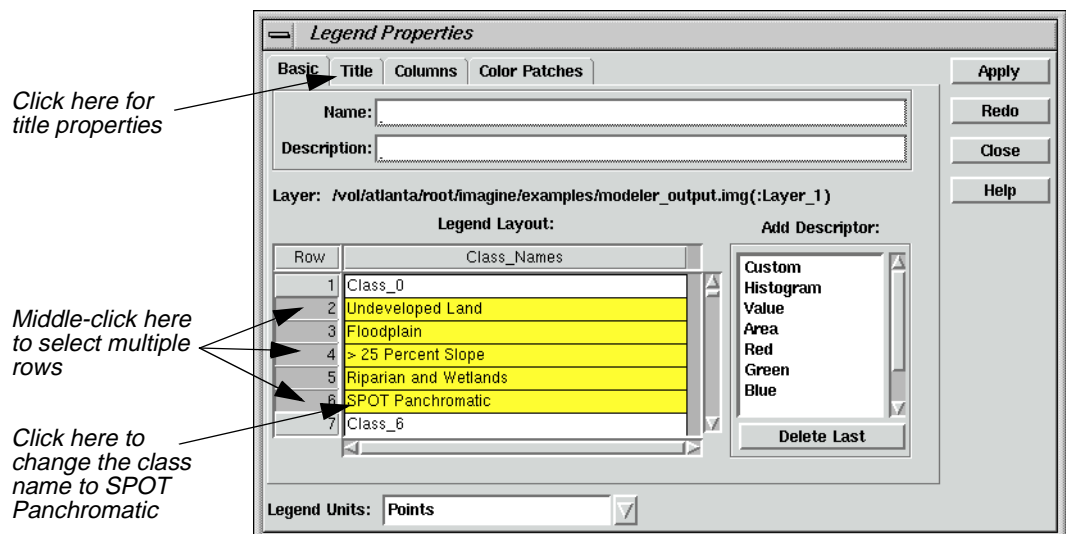

5. Under **Legend Layout**, click in the **Class\_Names** field (entitled **Class\_5**) of **Row** number **6**.
6. Type **SPOT Panchromatic**. Press Return on your keyboard.
7. Under **Legend Layout**, move your cursor to the **Row** column and click on **Row 2**, then middle-click on **Row 6** to select the classes to display in the legend.

Rows **2** and **6**, and the rows in between them are highlighted in yellow. These are the only entries that are used in the legend.



# Map Composer

8. In the Legend Properties dialog, click the **Title** tab at the top of the dialog.

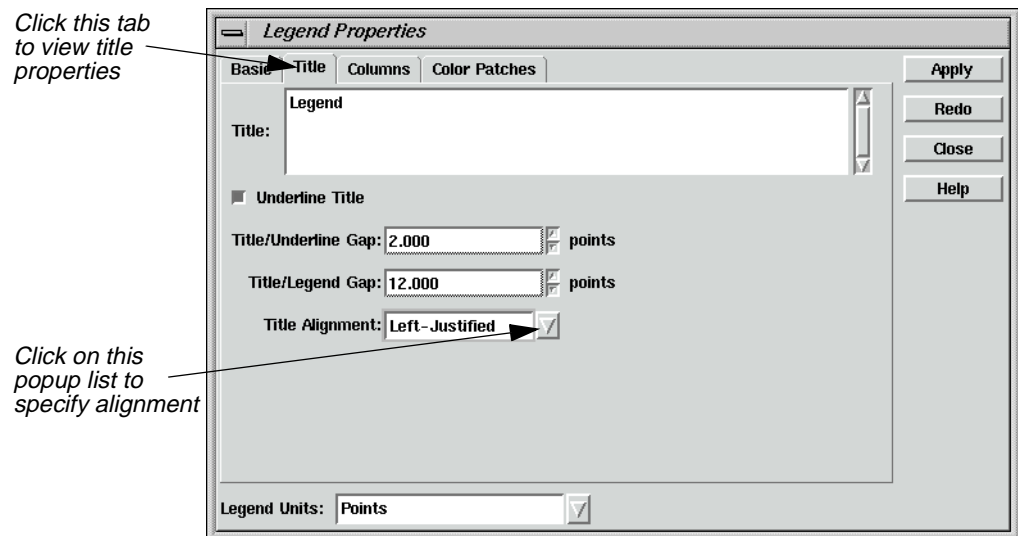

9. Click on the **Title Alignment** popup menu and select **Left-Justified**.
10. In the Legend Properties dialog, click **Apply**.
11. If you are not satisfied with the appearance of your legend, you may make adjustments in the Legend Properties dialog and click **Apply** or **Redo** to apply them.
12. Click **Close** in the Legend Properties dialog when finished.

## Reposition Legend

1. If you wish to reposition the legend, click on any of the color patches or text strings in the legend to select it. To move, hold and drag the selection box to the desired position. Remember to click outside the selection box to deselect the legend.

---

## Add a Map Title

### Prepare

You must have a map composition and the Annotation tool palette open.

1. Click on the Text icon in the Annotation tool palette.



2. Move your cursor to the top of the map in the Map Composer viewer. The cursor becomes an I-beam, indicating that you are placing text.



3. Click where you want to place the text. The spot where you click is the bottom left corner of your text string.

The Annotation Text dialog opens.

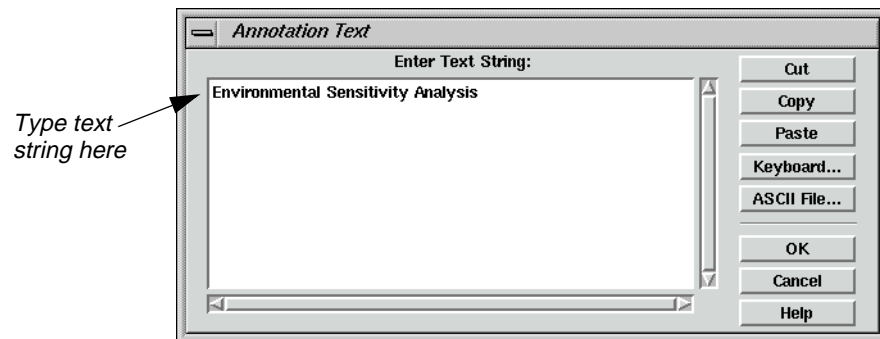

4. Move your pointer into the **Enter Text String** area in the Annotation Text dialog.
5. Type **Environmental Sensitivity Analysis** in the text field.
6. Click **OK** in the Annotation Text dialog to place the text in the map composition.

The text string is now displayed in the map composition.

### Change Text Style

1. Click on the text string in the Map Composer viewer to select it.
  2. From the Map Composer menu bar, select **Annotation | Styles**.
- The Styles dialog opens.
3. In the Styles dialog, hold on the popup list next to **Text Style** and select **Other**.

The Text Style Chooser dialog opens.

4. In the Text Style Chooser dialog, change the text **Size** to **20** points.

The preview window at the bottom right corner of the Text Style Chooser dialog illustrates the change in point size.

5. In the Text Style Chooser dialog, click on the **Custom** tab.
6. In the scrolling list of font names, scroll to the top of the list and select **Antique-Olive**.

The preview window at the bottom right corner of the dialog illustrates the selected font.

7. Click **Apply** in the Text Style Chooser dialog to change the selected text in the map composition.
8. Click **Close** in the Text Style Chooser dialog if you are satisfied with your changes.



# Map Composer

## Position Text

1. Double-click on the text string you just edited.

The Text Properties dialog opens, which allows you to edit, position, and align the text.

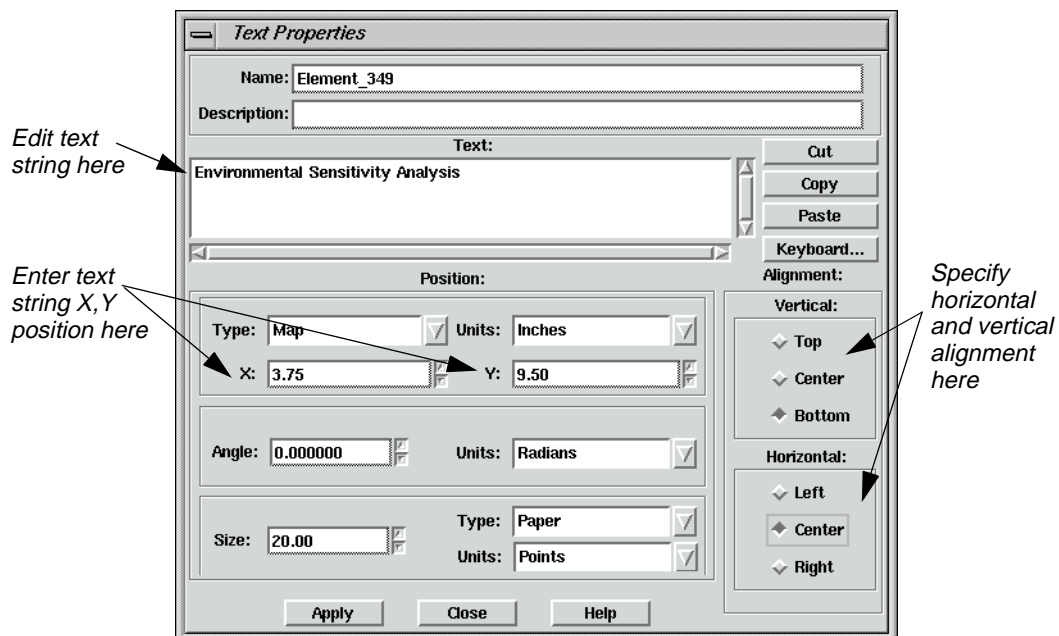

2. In the Text Properties dialog, under **Position**, drag across the **X** value to select it.
3. Type **7.5/2** to calculate the center of the map. Press Return.  
The value **3.75** is returned.
4. Change the **Y** value to **9.5** and press Return on the keyboard.
5. Under **Alignment**, the **Vertical** default should be **Bottom**. Click the **Center** radio button under **Horizontal**. This indicates that position **3.75 × 9.5** (that you just entered) is to be the bottom center of the text string.
6. Click **Apply** in the Text Properties dialog to center the text.
7. Click **Close** in the Text Properties dialog.
8. Deselect the text by clicking elsewhere in the background of the Map Composer viewer.

## Place a North Arrow

Map Composer contains many symbols, including north arrows. These symbols are predrawn groups of elements that are stored in a library. Other symbols include school, church, marsh, landmark, and many others.



### Prepare

You must have a map composition and the Annotation tool palette open.

1. If the Styles dialog is not currently open, select **Annotation | Styles** from the Map Composer menu bar.

The Styles dialog opens.

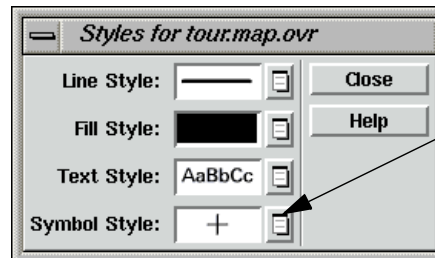

*Hold on this popup list to select Other*

2. In the Styles dialog, hold the popup list next to **Symbol Style** and select **Other**.

The Symbol Chooser dialog opens.

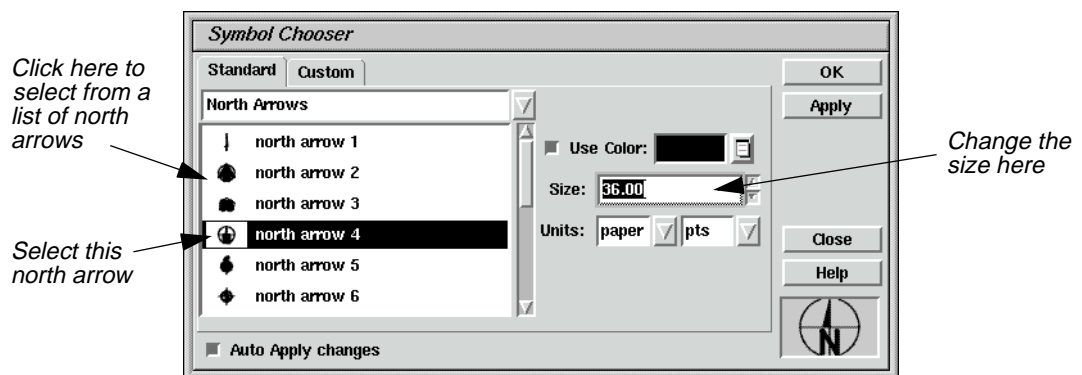

*Click here to select from a list of north arrows*

*Select this north arrow*

*Change the size here*

3. In the Symbol Chooser dialog, click on the popup list and select **North Arrows**.
4. Select **north arrow 4** from the **North Arrows** list.

The preview window at the bottom right corner of the Symbol Chooser dialog displays **north arrow 4**.

5. In the Symbol Chooser dialog, change the **Size** to **36** points (a size of 72 points is equal to one inch), and press Return on the keyboard.

The preview window at the bottom right corner of the Symbol Chooser dialog displays the north arrow as it looks in the map composition.

6. Click **Apply** and then **Close** in the Symbol Chooser dialog to make this the default symbol.

Note that the **North Arrow** is now the default symbol for **Symbol Style** in the Styles dialog.



## Map Composer

7. Select the Symbol tool from the Annotation tool palette.



8. In the Map Composer viewer, click under the map image, between the legend and the scale bars.

The north arrow is placed on your composition. You can reposition it by clicking on it to select it, then dragging it to the new position.

You can also double-click on a selected symbol to bring up the Symbol Properties dialog. Here, you can enter size and positioning measurements.

---

### Write Descriptive Text

You can add descriptive text to your map to provide more information. The steps below include the instructions for adding two lines of text. However, you may add more if you like.

#### Prepare

You must have a map composition and the Annotation tool palette open.

1. If the Styles dialog is not currently open, select **Annotation | Styles** from the Map Composer menu bar.

The Styles dialog opens.

2. In the Styles dialog, hold on the **Text Style** popup list and select **Other**.

The Text Style Chooser dialog opens.

3. In the Text Style Chooser dialog, change the text **Size** to **10** points.
4. Click on the **Custom** tab at the top of the Text Style Chooser dialog.
5. Check to be sure that **Fill Style** is set to **solid black**.
6. Click **Apply** to change the defaults.
7. Click **Close** in the Text Style Chooser dialog and in the Styles dialog.

#### Place Text

1. Click on the Text icon in the Annotation tool palette to use the text option to write descriptive text.



2. Click in the bottom right side of the map composition to indicate where you want to place the text.

The Annotation Text dialog opens.

3. Move your pointer into the Annotation Text dialog and type the following lines under **Enter Text String**. At the end of the first line, press Return to left-align the text.

### San Diego, California<return> Environmental Sensitivity Analysis



---

You may click the **ASCII File** button to import the text from an existing ASCII text file.

4. Click **OK** in the Annotation Text dialog to place the text.

The Annotation Text dialog automatically closes.

### Save the Map Composition

1. Save your map composition by clicking the Save icon in the Map Composer tool bar.



---

You can also save a composition by selecting **File | Save | Map Composition** from the Map Composer menu bar.

### Print the Map Composition

ERDAS IMAGINE supports many output devices, including electrostatic plotters, continuous tone color printers, and PostScript devices. The printers you can use vary depending on your system configuration. These steps illustrate how to print to a PostScript printer.

1. Click on the Composer icon from the ERDAS IMAGINE icon panel.



The **Map Composer** menu displays.

2. Select **Print Map Composition** from the **Map Composer** menu, or select **File | Print** from the Map Composer viewer menu bar.

The Compositions dialog opens.



# Map Composer

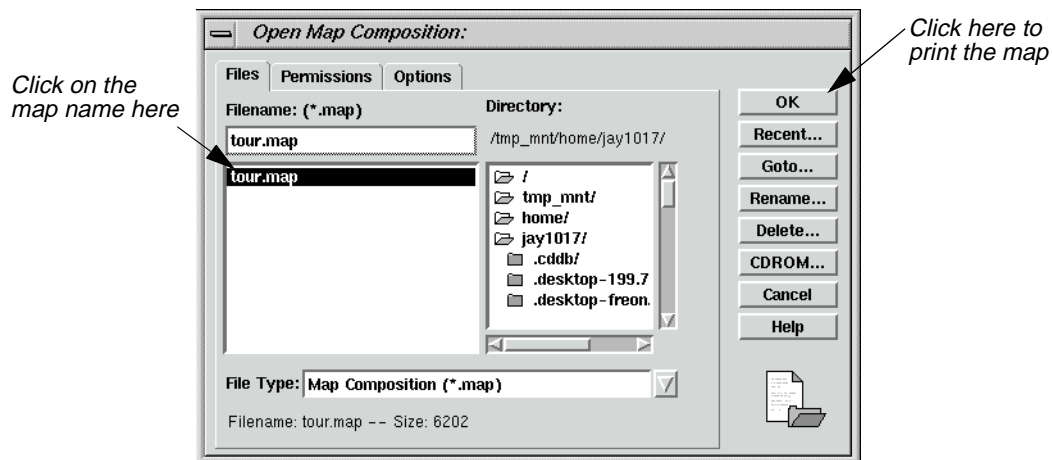

3. Under **Filename**, click on the name of the map you previously created.
4. Click **OK** in the Compositions dialog.

The Print Map Composition dialog opens.

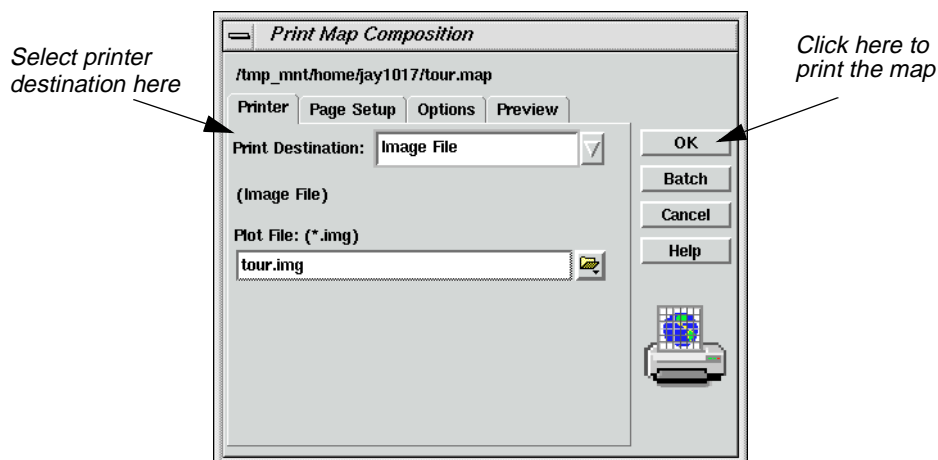

5. Click on the **Print Destination** popup list to select the printer you want to use.

If you do not have any output devices configured, you can output your map to an ERDAS IMAGINE image file (.img extension), and display it in a Viewer. When displaying maps converted to image format, assign bands 1, 2, 3 to R, G, B, respectively, in the Select Layer To Add dialog. This gives you an idea of what the map looks like if it is printed.

6. For this exercise, select **EPS File** in the **Print Destination** popup list to create an encapsulated PostScript file. This file can be sent to a PostScript printer using the standard file print command for your platform.
7. Click **OK** to print the map composition.



### Edit Composition Paths

This section describes how to edit a map composition when you want to use another image in an existing map frame, or if the original image you used has been moved to another directory.

#### .map File

When you create a map or a graphic using Map Composer, a file is created with the .map extension. This file contains all of the specifications for your composition, such as size, position of the image, name of the image, annotation, etc. When you display or print a map composition, the software reads this .map file and recreates the map you originally composed.

So, although you place an image in a composition, you are actually only referencing it. The name of the image you are using is listed in the .map file. Therefore, when that image is enhanced or changed in any way, the image in the map composition also changes because it is the same image.

It is necessary to edit a .map file if you wish to move an image that has been used in a map composition to a new directory.

#### Editing Annotation

The annotation in a map composition can be edited interactively with the Annotation tools in the Annotation tool palette, using the same methods you used to place the annotation when you originally created the map.

#### Prepare

You must have a saved map composition (.map file).

1. Click the Composer icon on the ERDAS IMAGINE icon panel.



The **Map Composer** menu displays.

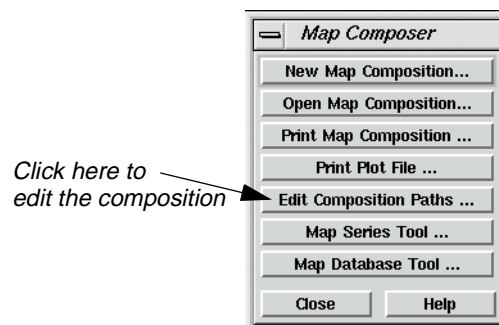

# Map Composer

2. In the **Map Composer** menu, select **Edit Composition Paths**.

The Map Path Editor displays.

3. In the Map Path Editor, select **File | Open** or click the Open icon.



The Compositions dialog opens.

4. In the Compositions dialog under **Filename**, select the map file you wish to edit (e.g., **tour.map**).
5. Click **OK** in the Compositions dialog.

The information for the selected map file displays in the Map Path Editor.

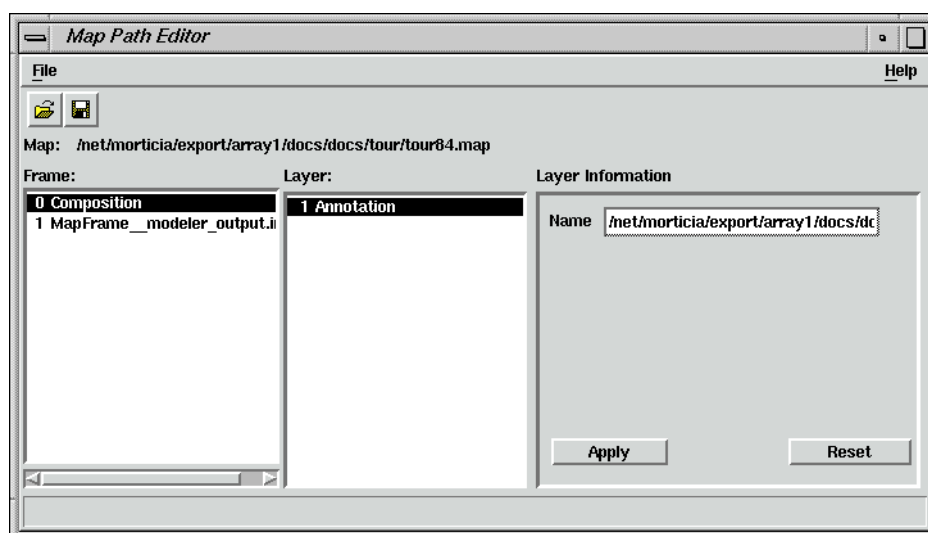

6. In the Map Path Editor under **Frame**, click **MapFrame\_modeler\_output.img**.

The type of **Layer** and **Layer Information** displays for the image. Note the path name for this image (located under **Layer Information** in the **Name** section).

7. Under **Frame**, click on **Composition**.
8. Under **Layer Information**, type the new file name or directory name in the **Name** text entry field.
9. Click **Apply** in the Map Path Editor.

The changes you made are applied to the map composition.



*After you make each individual edit to each frame or layer, you must click **Apply**.*

10. If you do not want the changes you have just made, click the **Reset** button.
11. When you are satisfied with your changes, save the file by selecting **File | Save** from the Map Path Editor menu bar.



---

*For more information about cartography, see "CHAPTER 12: Cartography" of the ERDAS Field Guide.*



---

*For more information about the Map Composer, see "APPENDIX A: Additional Information" on page 595.*



# Map Composer



# CHAPTER 4

## Classification

---

### Introduction

Classification is the process of sorting pixels into a finite number of individual classes, or categories of data based on their data file values. If a pixel satisfies a certain set of criteria, then the pixel is assigned to the class that corresponds to that criteria.

In this tour guide, you perform a basic unsupervised classification of an image file (.img).



---

*All of the data used in this tour guide are in the <IMAGINE\_HOME>/examples directory. You should copy the **germtm.img** file to a different directory so that you can have write permission to this file.*



---

*Approximate completion time for this tour guide is 20 minutes.*

---

### Use Unsupervised Classification

This section shows you how to create a thematic raster layer by letting the software identify statistical patterns in the data without using any ground truth data.

#### ISODATA Classifier

ERDAS IMAGINE uses the ISODATA algorithm to perform an unsupervised classification. The ISODATA clustering method uses the minimum spectral distance formula to form clusters. It begins with either arbitrary cluster means or means of an existing signature set. Each time the clustering repeats, the means of these clusters are shifted. The new cluster means are used for the next iteration.

The ISODATA utility repeats the clustering of the image until either a maximum number of iterations has been performed, or a maximum percentage of unchanged pixel assignments has been reached between two iterations.

Performing an unsupervised classification is simpler than a supervised classification because the signatures are automatically generated by the ISODATA algorithm.

In this example, you generate a thematic raster layer using the ISODATA algorithm.

#### Prepare

You must have ERDAS IMAGINE running.



# Classification

1. Click on the DataPrep icon in the ERDAS IMAGINE icon panel.



The **Data Preparation** menu opens.

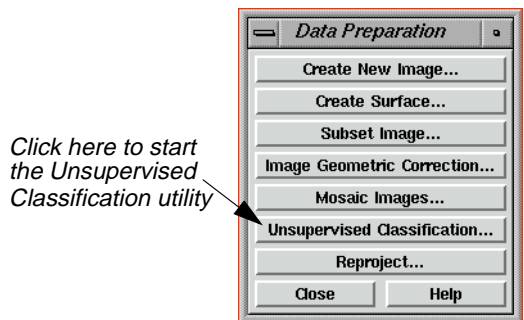

## Generate Thematic Raster Layer

1. Select **Unsupervised Classification** from the **Data Preparation** menu to perform an unsupervised classification using the ISODATA algorithm.

The Unsupervised Classification (Isodata) dialog opens.

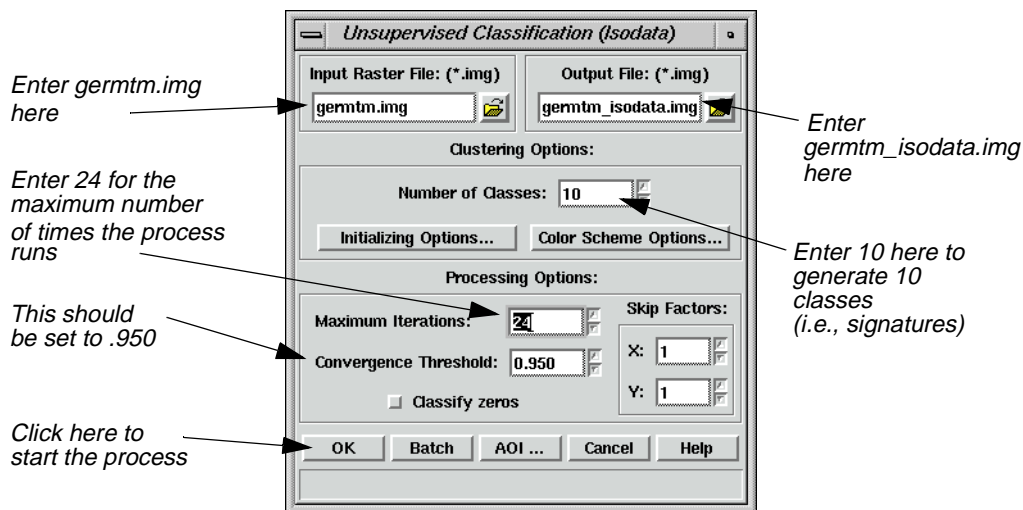

2. Click **Close** in the **Data Preparation** menu to clear it from the screen.
3. In the Unsupervised Classification dialog under **Input Raster File**, enter **germtm.img**. This is the image file that is classified.

4. Under **Output File**, enter **germtm\_isodata.img** in the directory of your choice.

This is the name for the output thematic raster layer.

### Set Initial Cluster Options

The Clustering Options allow you to define how the initial clusters are generated.

5. Under **Clustering Options**, enter **10** in the **Number of Classes** field.

### Choose Processing Options

The Processing Options allow you to specify how the process is performed.

1. Enter **24** in the **Maximum Iterations** number field under **Processing Options**.

This is the maximum number of times that the ISODATA utility reclusters the data. It prevents this utility from running too long, or from potentially getting stuck in a cycle without reaching the convergence threshold.

2. Confirm that the **Convergence Threshold** number field is set to **.950**.

### Convergence Threshold

The convergence threshold is the maximum percentage of pixels whose cluster assignments can go unchanged between iterations. This threshold prevents the ISODATA utility from running indefinitely.

By specifying a convergence threshold of .95, you are specifying that as soon as 95% or more of the pixels stay in the same cluster between one iteration and the next, the utility should stop processing. In other words, as soon as 5% or fewer of the pixels change clusters between iterations, the utility stops processing.

3. Click **OK** in the Unsupervised Classification dialog to start the classification process. The Unsupervised Classification dialog closes automatically.

A Job Status dialog displays, indicating the progress of the function.

*NOTE: This process could take up to 15 minutes, depending upon your hardware capabilities.*

4. In the Job Status dialog, click **OK** when the process is 100% complete.
5. Proceed to the “Use Unsupervised Classification” section to analyze the classes, so that you can identify and assign class names and colors.



# Classification

## Evaluate Classification

After a classification is performed, you can use a classification overlay or recode the classes to evaluate and test the accuracy of the classification.

## Create Classification Overlay

In this example, you use the Raster Attribute Editor to compare the original image data with the individual classes of the thematic raster layer that was created from the unsupervised classification (**germtm\_isodata.img**). This process helps identify the classes in the thematic raster layer. You may also use this process to evaluate the classes of a thematic layer that was generated from a supervised classification.

### Prepare

ERDAS IMAGINE should be running and you should have a Viewer open.

### Display Files

1. Select **File | Open | Raster Layer** from the Viewer menu bar to display the **germtm.img** continuous raster layer.

The Select Layer To Add dialog opens.

*Click on this file tab to see the raster options*

*Click here to select germtm.img*

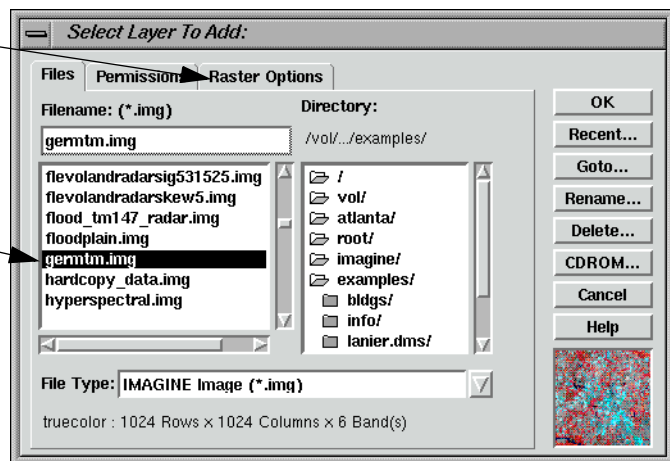

2. In the Select Layer To Add dialog under **Filename**, select **germtm.img**.
3. Click the Raster Options tab at the top of the Select Layer To Add dialog.
4. Set **Layers to Colors** at **4, 5, and 3**, respectively.
5. Click **OK** in the Select Layer To Add dialog to display the image file.
6. Select **File | Open | Raster Layer** from the Viewer menu bar to display the thematic raster layer, **germtm\_isodata.img**, over the **germtm.img** file.

The Select Layer To Add dialog opens.

7. Under **Filename**, open the directory in which you previously saved **germtm\_isodata.img** by entering the directory path name in the text entry field and pressing the Return key on your keyboard.



8. Select the file **germtm\_isodata.img** from the list of files in the directory.  
You are going to evaluate/identify the classes in this file.
9. Click the Raster Options tab at the top of the Select Layer To Add dialog.
10. Click **Clear Display** to turn off this checkbox.
11. Click **OK** in the Select Layer To Add dialog to display the image file.

### Open Raster Attribute Editor

1. Select **Raster | Attributes** from the Viewer menu bar.

The Raster Attribute Editor displays.

2. In the Raster Attribute Editor, select **Edit | Column Properties** to rearrange the columns in the CellArray so that they are easier to view.

The Column Properties dialog opens.

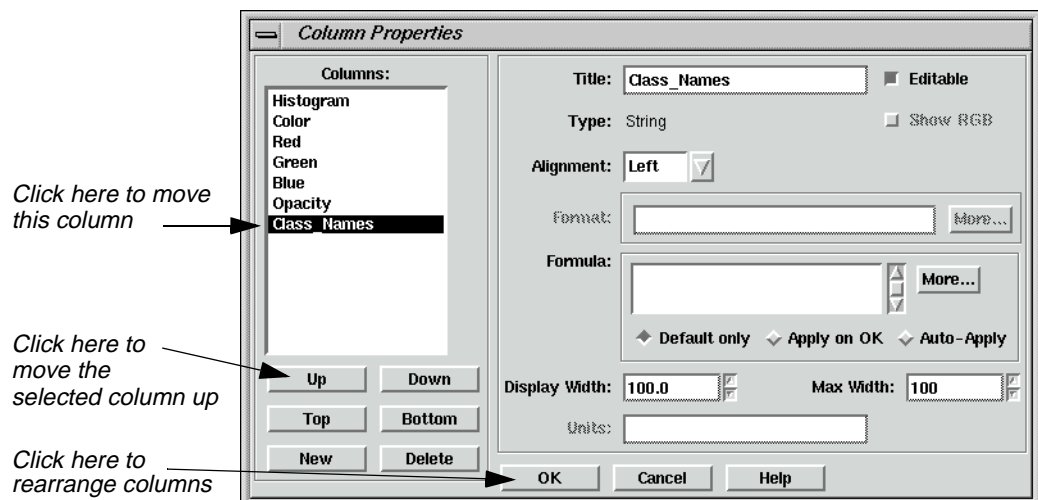

3. In the Column Properties dialog under **Columns**, select **Opacity**, then click **Up** to move **Opacity** so that it is under **Histogram**.
4. Select **Class\_Names**, then click **Up** to move **Class\_Names** so that it is under **Color**.
5. Click **OK** in the Column Properties dialog to rearrange the columns in the Raster Attribute Editor.

The Column Properties dialog closes.



# Classification

The data in the Raster Attribute Editor CellArray should appear similar to the following example:

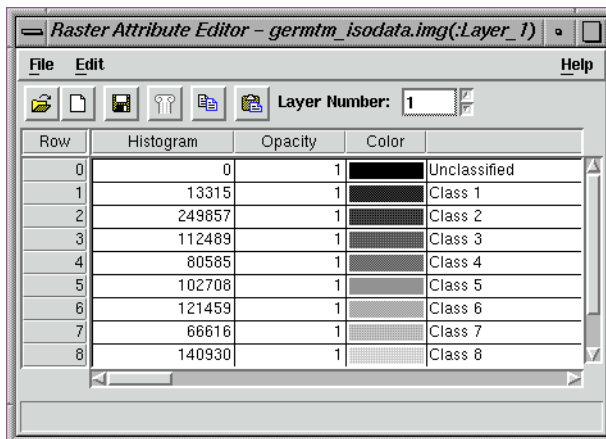

Row	Histogram	Opacity	Color	
0	0	1	Black	Unclassified
1	13315	1	Black	Class 1
2	249857	1	Black	Class 2
3	112489	1	Black	Class 3
4	80585	1	Black	Class 4
5	102708	1	Black	Class 5
6	121459	1	Black	Class 6
7	66616	1	Black	Class 7
8	140930	1	Black	Class 8

## Analyze Individual Classes

Before you can begin to analyze the classes individually, you need to set the opacity for all of the classes to zero.

1. In the Raster Attribute Editor, click on the word **Opacity** at the top of the **Opacity** column to select all of the classes.
2. In the Raster Attribute Editor, right-hold on the word **Opacity** at the top of the **Opacity** column and select **Formula** from the **Column Options** menu.

The Formula dialog opens.

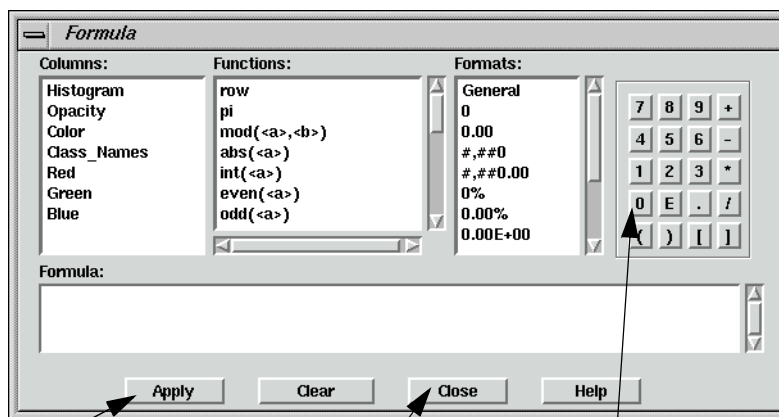

Click here to apply a 0 value to the Opacity column

Click here to close this dialog

Click here to enter a 0 in the Formula

3. In the Formula dialog, click **0** in the number pad.

A **0** is placed in the **Formula** field.

4. In the Formula dialog, click **Apply** to change all of the values in the **Opacity** column to **0**, and then click **Close**.
5. In the Raster Attribute Editor, click and hold on the color patch under **Color** for **Class 1** in the CellArray and change the color to **Yellow**. This provides better visibility in the Viewer.
6. Verify the **Opacity** for **Class 1** in the CellArray is set to **1**.  

This class is shown in the Viewer.
7. In the Viewer menu bar, select **Utility | Flicker** to analyze which pixels are assigned to this class.  

The Viewer Flicker dialog opens.
8. Turn on the **Auto Mode** in the Viewer Flicker dialog by clicking on the checkbox.  

The flashing black pixels in the **germtm.img** file are the pixels of this class. These areas are water.
9. In the Raster Attribute Editor, click inside the **Class\_Names** column for **Class 1**. (You may need to double-click in the column.) Change this name to **Water** and then press Return on the keyboard.
10. In the Raster Attribute Editor, click and hold on the **Color** patch for **Water** and select **Blue** from the popup list. (You may need to select the entire row for this class first.)
11. After you are finished analyzing this class, click **Cancel** in the Viewer Flicker dialog and set the **Opacity** for **Water** back to **0** in the Raster Attribute Editor. Press Return on the keyboard.
12. Change the **Color** for **Class 2** in the CellArray to **Yellow** for better visibility in the Viewer.
13. Change the **Opacity** for **Class 2** to **1** and press Return on the keyboard.  

This class is shown in the Viewer.
14. In the Viewer menu bar, select **Utility | Flicker** to analyze which pixels are assigned to this class.  

The Viewer Flicker dialog opens.
15. Turn on the **Auto Mode** in the Viewer Flicker dialog.  

The flashing yellow pixels in the **germtm.img** file should be the pixels of this class. These are forest areas.
16. In the Raster Attribute Editor, click inside the **Class\_Names** column for **Class 2**. (You may need to double-click in the column.) Change this name to **Forest**, then press Return on the keyboard.
17. In the Raster Attribute Editor, click and hold on the **Color** patch for **Forest** and select **Pink** from the popup list. (You may need to select the entire row for this class first.)
18. After you are finished analyzing this class, click **Cancel** in the Viewer Flicker dialog and set the **Opacity** for **Forest** back to **0**. Press Return on the keyboard.



## Classification

19. Repeat these steps with each class so that you can see how the pixels are assigned to each class. You may also try selecting more than one class at a time.
20. Continue assigning names and colors for the remaining classes in the Raster Attribute Editor CellArray.
21. In the Raster Attribute Editor, select **File | Save** to save the data in the CellArray.
22. Select **File | Close** from the Raster Attribute Editor menu bar.
23. Select **File | Clear** from the Viewer menu bar.



---

*For more information about the Classification, see "APPENDIX A: Additional Information" on page 595.*

# CHAPTER 5

## Vector Querying and Editing

---

### Introduction

The IMAGINE Vector capabilities are designed to provide you with an integrated GIS package for raster and vector processing. The Vector tools in ERDAS IMAGINE are based on the ESRI data models, therefore ArcInfo vector coverages, ESRI shapefiles, and ESRI SDE vectors can be used in ERDAS IMAGINE with no conversion.

This tour guide explains how to edit vector layers



---

*The data used in this tour guide are in the <IMAGINE\_HOME>/examples directory. Replace <IMAGINE\_HOME> with the directory where ERDAS IMAGINE is installed on your system (e.g., /usr/imagene/850).*



---

*ESRI SDE layers cannot be edited. They can only be displayed, queried, and symbolized.*



---

*A Digitizing Template is supplied in the information packet for ERDAS IMAGINE V8.5.*



---

*For more information about IMAGINE Vector, see "CHAPTER 20: IMAGINE Vector™" on page 573.*

This tour guide covers the following topics:

- creating new vector layers
- changing vector properties
- creating attributes



---

*Approximate completion time for this tour guide is 55 minutes.*

---

### Query Vector Data

*NOTE: The following section covers only the native Vector functionalities in ERDAS IMAGINE. If you have the IMAGINE Vector module, please see "Section V IMAGINE Vector™" on page 571.*

### Copy Vector Data

#### Prepare

Move to the directory where you want to create your workspace. Start ERDAS IMAGINE from this directory. Make sure this is a directory in which you have read/write permission.



# Vector Querying and Editing

1. Click on the Vector icon from the ERDAS IMAGINE icon panel.



The **Vector Utilities** menu opens.

Click here to copy sample vector layer

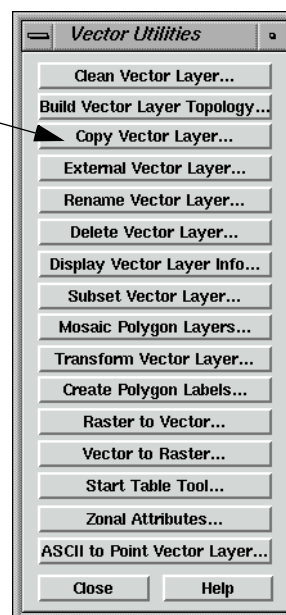

*The vector utilities in this menu should NOT be run on open vector layers. Close the layer you are using before running the utility, and do NOT attempt to open the layer until the process is complete.*

2. In the **Vector Utilities** menu, select **Copy Vector Layer**.

The Copy Vector Layer dialog opens.

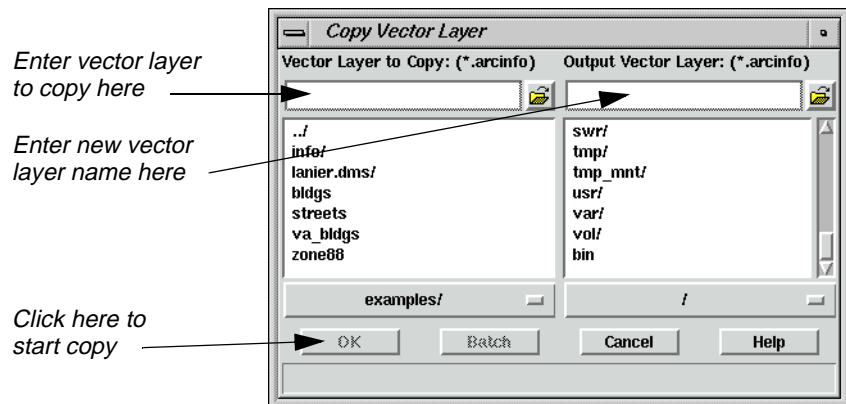

3. In the Copy Vector Layer dialog under **Vector Layer to Copy**, select the file named **zone88**.
4. Under **Output Vector Layer**, enter **zone88** in the directory of your choice. This should be the directory from which you started ERDAS IMAGINE.
5. Click **OK** in the Copy Vector Layer dialog.

A Job Status dialog displays to track the progress of the function. When the Copy ArcInfo coverage process is complete, the files are copied and you are ready to proceed with this tour guide.

6. Click **Close** in the **Vector Utilities** menu to dismiss it.

## Display Vector Layers

### Prepare

ERDAS IMAGINE should be running and a Viewer should be open. You must have completed the section, “Copy Vector Data” on page 109.

1. In the Viewer menu bar select **File | Open | Vector Layer**.

The Select Layer To Add dialog opens.

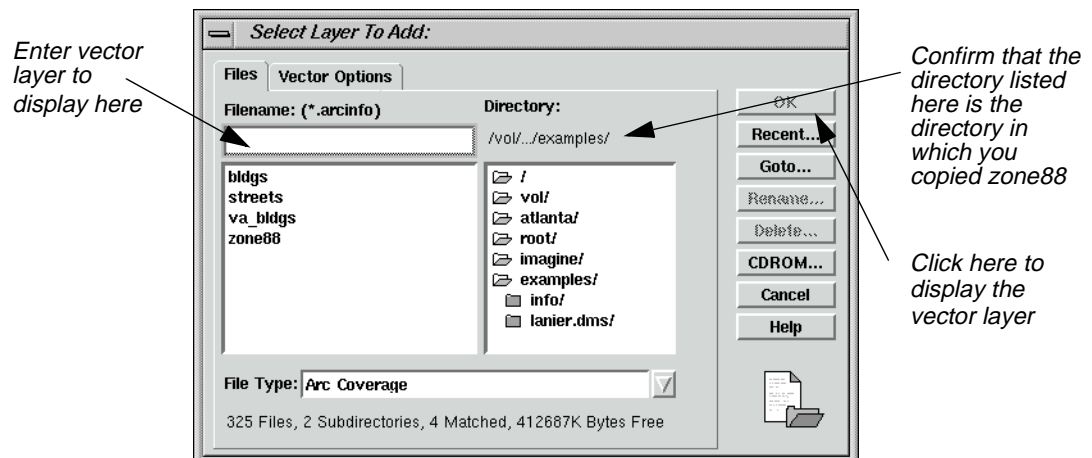

# Vector Querying and Editing

2. Under **Filename** select **zone88** from the directory in which you saved it in the last section.
3. Click **OK** to display the layer in the Viewer.

The **zone88** polygon layer is displayed in the Viewer, similar to the following example:

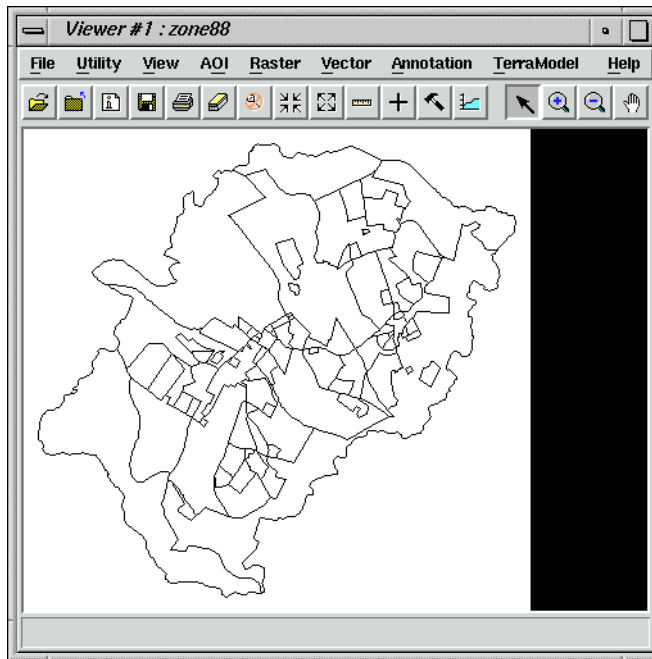

## Change Vector Properties

1. Select **Vector | Viewing Properties** from the Viewer menu bar.

The Properties dialog opens.

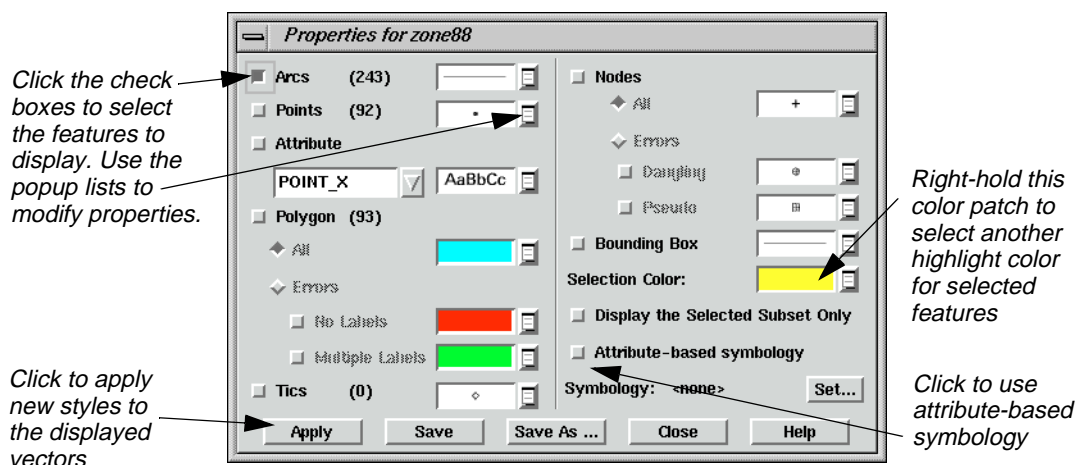



This dialog allows you to determine which and how vector features (lines, points, attributes, polygons, tics, and nodes) are displayed. You can also select the color to use for selected features.

In this example, the lines are currently displayed in the Viewer using the default styles shown in the Properties dialog.

2. In the Properties dialog, click to turn off the **Arcs** checkbox, then click to turn on **Points**.
3. Click **Apply** in the Properties dialog.

Now, points are displayed in the Viewer and lines are not. These are the polygon label points.

4. In the Properties dialog, click **Points, Arcs, Polygon**, and then **Apply**, so that lines and polygons are displayed and points are not.
5. Left-hold (for UNIX) or left-click (for PC) on the popup list next to **Arcs** and select **Other** to change the line style used.

The Line Style Chooser dialog opens.

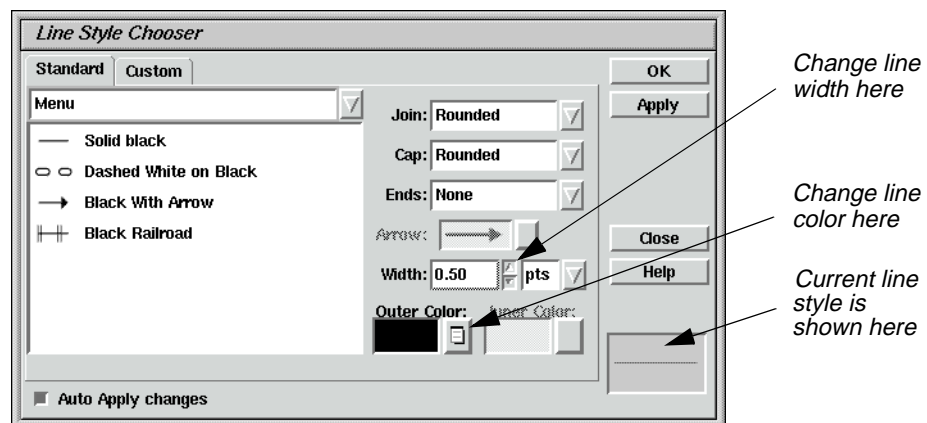

6. In the Line Style Chooser dialog, change the **Width** to **2.00** points.
7. Left-hold (UNIX) or left-click (PC) on the **Outer Color** popup list and select **Red**.
8. Click **Apply** and then **Close** in the Line Style Chooser dialog.

The Line Style Chooser dialog closes. The new line style is reflected in the Properties dialog.

9. Click **Apply** in the Properties dialog to change the displayed vectors in the Viewer.

The vectors are redrawn in the Viewer as thick, red lines.

10. In the Properties dialog, right-hold on the popup list next to **Arcs** and select **Other** again.

The Line Style Chooser dialog opens.

## Vector Querying and Editing

11. Change the **Outer Color** back to **Black** and the **Width** back to **0.500** points, then click **Apply**.
12. Click **Close** in the Line Style Chooser dialog and then click **Apply** in the Properties dialog.  
The lines are redisplayed in black.

### Display Attributes in the Viewer

1. In the Properties dialog, click the **Points** and **Attribute** checkboxes, then click on the popup list under **Attribute** and select **ZONING**.
2. Click **Apply** in the Properties dialog.  
The polygon label points and zone numbers display in the Viewer.
3. In the Properties dialog, click the **Attribute** checkbox to deselect it, and then click **Apply**.
4. Click **Close** in the Properties dialog.
5. An Attention dialog displays, asking if you want to save these styles in a symbology file. Click **No**.  
The Properties dialog closes.

### View Attributes

1. In the Viewer tool bar, click the Tools icon (or select **Vector | Tools** from the Viewer menu bar).



The Vector tool palette displays

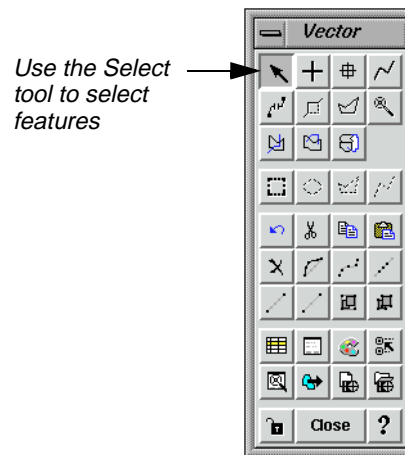

*NOTE: Depending on the package you have, your tool palette may include more icons than the one pictured above. If you have the IMAGINE Vector module, please see “Section V IMAGINE Vector™” on page 571 for a description of the entire Vector tool palette.*

2. With your cursor in the Viewer, click on a polygon to select it (the Select tool is enabled by default in the Vector tool palette).

The selected polygon is highlighted in yellow.

3. Shift-click on another polygon to add to the selection.

Now two polygons are highlighted in yellow.

4. Click outside of the polygons (within the Viewer) to deselect everything.

5. In the Viewer menu bar, select **Vector | Attributes**.

The Attributes dialog displays, as in the following example:



## Vector Querying and Editing

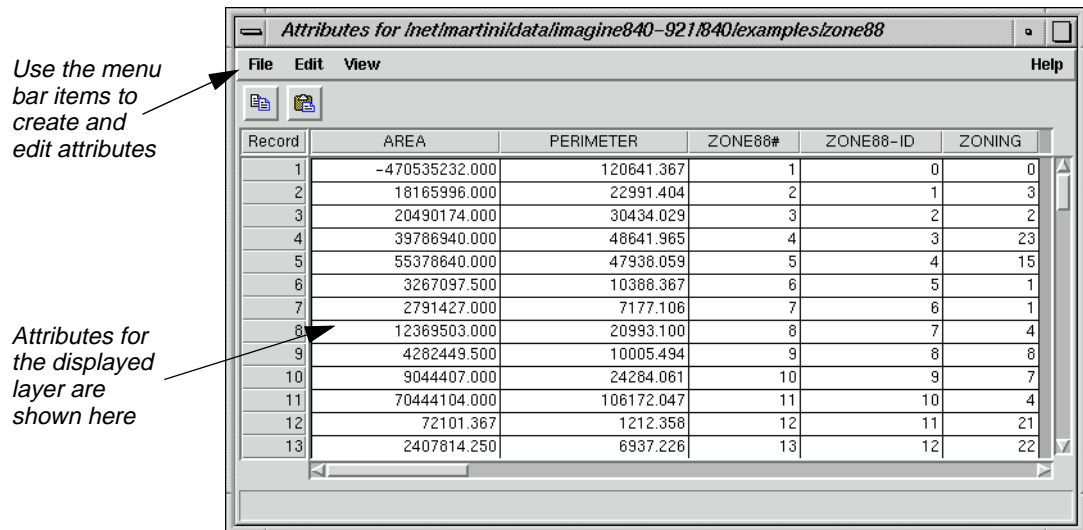

Polygon attributes are displayed in a CellArray. Therefore, you have access to the same tools that you use in other CellArrays.

6. In the Viewer, click on another polygon to select it.

The polygon is highlighted in yellow in the Viewer, and the corresponding record in the Attributes CellArray is also highlighted.

7. Click on a record number under **Record** in the Attributes CellArray to select it.

That record is highlighted in the CellArray and the corresponding polygon is highlighted in the Viewer.

8. With your cursor in the **Record** column of the Attributes CellArray, right-hold **Row Selection | Select All**.

All features in both the CellArray and the Viewer are selected.

9. With your cursor in the **Record** column of the Attributes CellArray, right-hold **Row Selection | Select None** to deselect all features.

### Use the Marquee Tools to Select Features

1. In the Viewer menu bar, select **Vector | Options**.

The Options dialog opens.

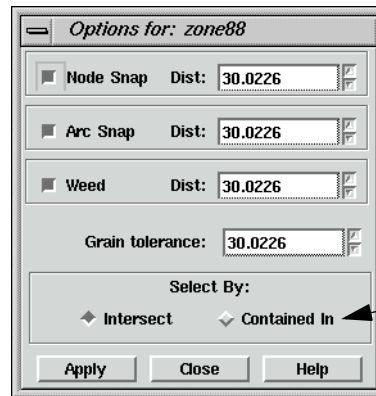

*Click here to restrict selection to only those features within the marquee boundary*

2. In the Options dialog under **Select By**, click the **Contained In** checkbox.
3. Click **Apply** in the Options dialog.

When you use the marquee tools in the Vector tool palette now, only the features completely contained within the boundary of the marquee are selected.

4. Click the Marquee icon in the Vector tool palette.



5. Drag to draw a rectangle in the Viewer.

When you release the mouse button, the polygons and lines contained within the rectangle are selected (outlined in yellow). The corresponding attributes are selected in the Attribute CellArray.

6. In the Viewer, click outside of the polygons to deselect all features.
7. Click the Line Selection icon in the Vector tool palette.



8. In the Viewer, click to start drawing a line over the vectors and either double-click or middle-click once (depending on how your Preferences are set) to terminate the line.

The features that intersect the line are selected in the Viewer and in the Attribute CellArray.

9. In the Viewer, click outside of the polygons to deselect everything.
10. Click **Close** in the Options dialog.

# Vector Querying and Editing

## Use the Criteria Function

1. With your cursor in the **Record** column of the Attributes CellArray, right-hold **Row Selection | Criteria**.

The Selection Criteria dialog opens.

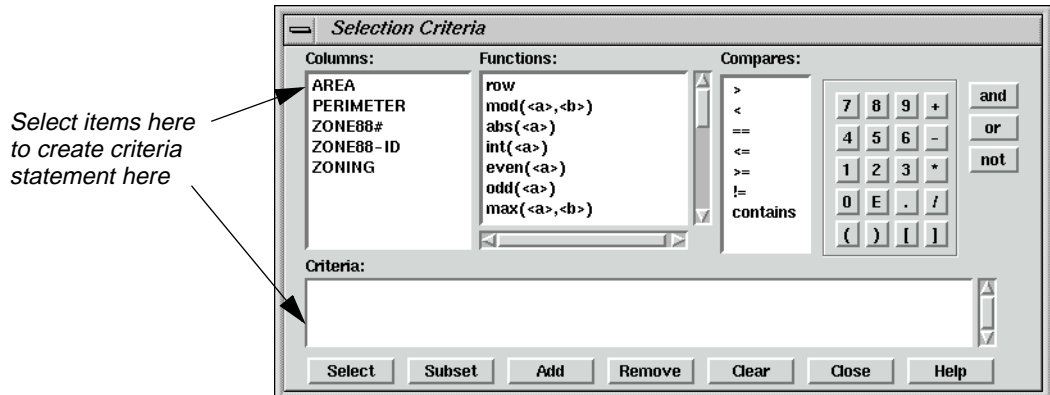

Next, you create a criteria statement to select only those polygons that have an area greater than 5,000,000 square feet.

2. In the Selection Criteria dialog, click on **AREA** under **Columns**.

**\$"AREA"** is now written in the Criteria statement box at the bottom of the Selection Criteria dialog.

3. Under **Compares**, click on **>**.

The greater than symbol displays in the Criteria statement.

4. Use the numeric keypad to enter the number **5000000**.

The Criteria statement now reads:

**\$"AREA" > 5000000**

5. Click **Select** to compare the attributes in the Attributes CellArray against this criteria statement.

Only those records that meet the criteria are selected and highlighted in the Viewer and Attributes CellArray.

Now, you further refine the criteria by limiting the selection to only those polygons that are both greater than 5,000,000 square feet and in zone 4.

6. In the Selection Criteria dialog, click the **and** button.
7. Under **Columns**, click **ZONING**.
8. Under **Compares**, click **==**.

9. In the numeric keypad, click **4**.

The Criteria statement now reads:

**\$\$"AREA" > 5000000 and \$\$"ZONING" == 4**

10. Click **Select** in the Selection Criteria dialog.

All polygons greater the 5,000,000 square feet and in zone 4 are selected in the Viewer and in the Attribute CellArray.

11. Click **Close** in the Selection Criteria dialog.

12. In the Viewer, click outside of the polygons (within the Viewer) to deselect everything.

13. Click **Close** in the Vector tool palette.

14. Select **File | Close** from the Attributes dialog.

15. Select **File | Clear** from the Viewer.

---

### Edit Vector Layers

For this section, display a Landsat TM raster layer, then overlay the vector layer you have been using.

#### Prepare

ERDAS IMAGINE should be running and you should have a Viewer open.

1. Select **File | Open | Raster Layer** from the Viewer menu bar or click the Open icon on the tool bar.



The Select Layer To Add dialog opens.

2. In the Select Layer To Add dialog under **Filename**, select **germtm.img** from the file list.
3. Click the **Raster Options** tab at the top of the dialog, and then click on the **Fit to Frame** option so that the entire layer is visible in the Viewer.
4. Click **OK** in the Select Layer To Add dialog.

The file **germtm.img** is displayed in the Viewer.

5. In the Viewer menu bar, select **File | Open | Vector Layer**.

The Select Layer To Add dialog opens.



## Vector Querying and Editing

6. In the Select Layer To Add dialog under **Filename**, select **zone88**.

*NOTE: If **zone88** does not appear in the file list, click on the popup list next to **File Type** and select **Arc Coverage**.*

7. Click the **Vector Options** tab at the top of the dialog, and then confirm that the **Use Symbology** checkbox is turned off. Also, make sure that the **Clear Display** checkbox is turned off, so that the raster layer remains in the Viewer.
8. Click **OK** in the Select Layer To Add dialog.

The vector layer is displayed over the raster layer. Since the vectors are black, they may not be easily visible.

9. With your cursor in the Viewer, right-hold **Quick View | Zoom | Rotate and Magnify Area**.

A white rotation box displays in the Viewer and a Rotate/Magnify Instructions box also displays.

10. Drag the white rotation box so that it is positioned over the vector layer in the Viewer. Make it just big enough to cover the vectors, then double-click within the rotation box to magnify that area.

The Rotate/Magnify Instructions box dismisses and both the raster and vector layers are magnified in the Viewer.



*For other methods of zooming into an area of interest, see "Animated Zoom", "Box Zoom", and "Real-time Zoom", starting on page 18.*

### Change Viewing Properties

1. In the Viewer menu bar, select **Vector | Viewing Properties**.

The Properties dialog opens.

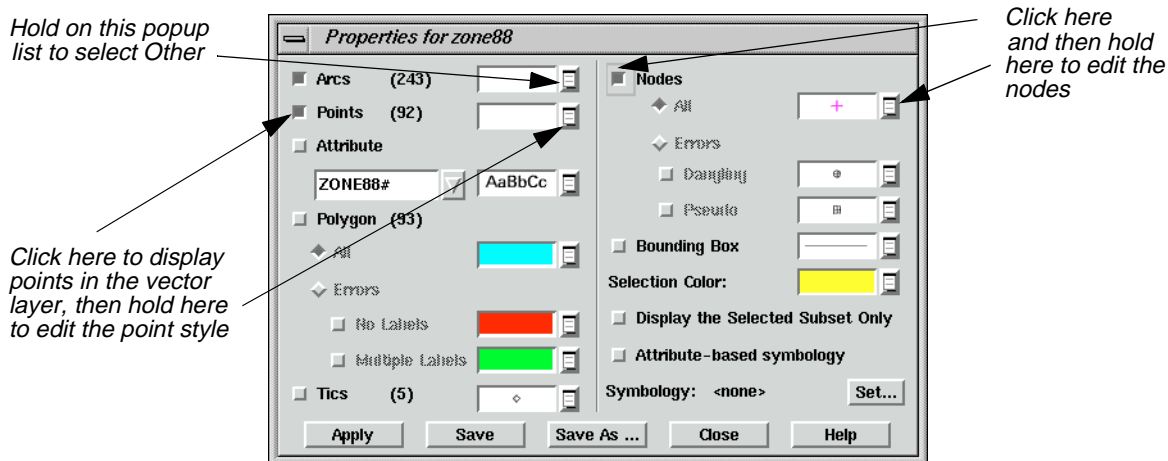

2. In the Properties dialog, hold on the popup list next to **Arcs** and select **Other**.



The Line Style Chooser dialog opens.

3. In the Line Style Chooser dialog, change the **Width** to **2.00** points, and hold on the **Outer Color** popup list to select **White**.
4. Click **Apply** and then **Close** in the Line Style Chooser dialog.
5. Click **Points** in the Properties dialog to display points.
6. Hold on the popup list next to **Points** and select **Other** to change the style of the points so that they are more visible.

The Symbol Chooser dialog opens.

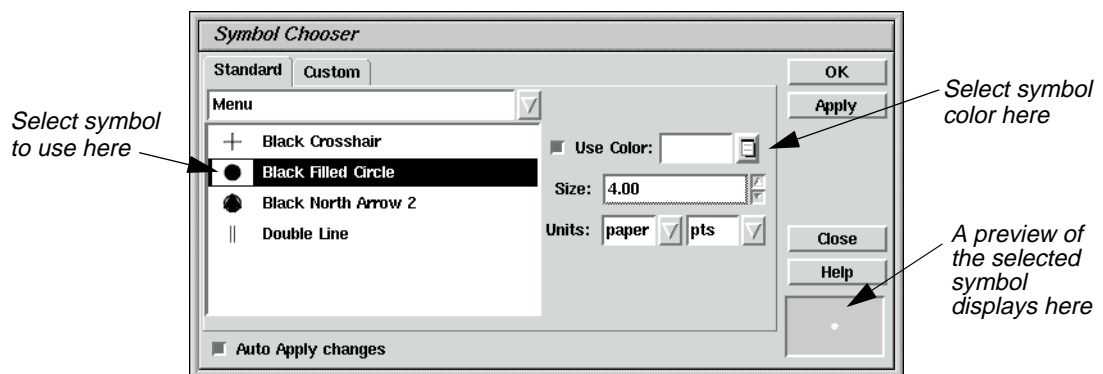

7. In the Symbol Chooser dialog under **Menu**, click **Black Filled Circle**.
8. Hold on the **Use Color** popup list and select **White**.
9. Change the **Size** to **4.00** points.
10. Click **Apply** and then **Close** in the Symbol Chooser dialog.

The new style is reflected in the Properties dialog (although you cannot see it because it is a white symbol against a white background).

11. In the Properties dialog, click **Nodes**, then hold on the popup list next to **All** and select **Other** to change the style of nodes.

The Symbol Chooser dialog opens.

12. Change the **Size** of the symbol to **6.00** points.
13. Hold on the **Use Color** popup list and change the color of the symbol to something that is visible over **germtm.img**, such as **Magenta**.
14. When you have selected a color, click **Apply** and then **Close** in the Symbol Chooser dialog.
15. Click **Apply** in the Properties dialog.



# Vector Querying and Editing

The vectors and points are drawn in white, and the nodes appear in the color you selected in step 13.

16. Click **Close** in the Properties dialog.
17. An Attention dialog displays, asking if you want to save your changes to a symbology file. Click **No**.

## Use Editing Tools and Commands

1. In the Viewer menu bar, select **Vector | Tools**.

The Vector tool palette displays.



*For information about the Vector tools, see “Viewer” on page 639.*

2. In the Vector tool palette, move the selector over each of the icons to view the single-line help that describes them in the lower portion of the Viewer.
3. In the Viewer menu bar, select **Vector | Enable Editing**.
4. In the Viewer, click on a line that you want to edit.

The selected line is highlighted in yellow and it is enclosed in a rotation box. You can simply hold and drag the entire box to move the line. You can hold and drag any of the handles on the box to enlarge or reduce the size of the line, or you can rotate the box.

5. In the Vector tool palette, click on the Split tool.



Your pointer is now a white crosshair when you move it back into the Viewer.

6. Click somewhere on the selected line to split it into two lines.

A node is placed where you clicked.

7. Click again on the line you split.

Only that part of the line is selected, since it is now two lines.

8. Shift-click on the other part of the split line.

Now both parts of the line are selected.

9. In the Viewer menu bar, select **Vector | Join**.

The node is removed, and the two lines form a single line again.

10. With the line still selected, select **Vector | Reshape** from the Viewer menu bar.

The vertices of the line display, similar to the following example.

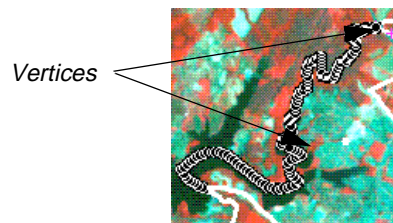

Each vertex is marked by a black dot in the example above.

11. Drag one of the vertices to a new location to reshape the line.
12. Select **Vector | Undo** from the Viewer menu bar to undo this edit.

The line is restored to its original shape and it is deselected.

*NOTE: To delete a vertex, you can Shift-middle click. To add a vertex, middle-click.*

### Create New Vector Layer

1. Click the **Viewer** icon in the ERDAS IMAGINE icon panel.



A new Viewer opens.

2. In the new Viewer (Viewer #2) select **File | Open | Raster Layer**.

The Select Layer To Add dialog opens.

3. In the Select Layer To Add dialog, select **IMAGINE Image** from the **File Type** popup list.



## Vector Querying and Editing

4. Under **Filename**, click on the file **germtm.img**.
5. Click on the **Raster Options** tab at the top of the dialog and confirm that the **Fit to Frame** option is enabled.
6. Click **OK** in the Select Layer To Add dialog.

The file **germtm.img** displays in the Viewer.

7. In the Viewer #2 menu bar, select **File | New | Vector Layer**.

The New Vector Layer dialog opens.

8. In the New Vector Layer dialog under **Vector Layer**, enter a name for the new layer, such as **zone88subset**, in the directory of your choice.



---

*Vector coverages include Arc Coverage, SDE Vector Layer, and Shapefile.*

9. Click **OK** in the New Vector Layer dialog.

The New Arc Coverage Layer Option dialog opens.

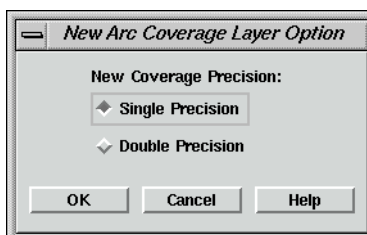

10. Confirm that **Single Precision** is selected.
11. Click **OK** in the New Arc Coverage Layer Option dialog.

The title bar in Viewer #2 reflects the name of the new vector layer you are creating.

12. In the menu bar of Viewer #1, select **Vector | Options**.

The Options dialog opens.

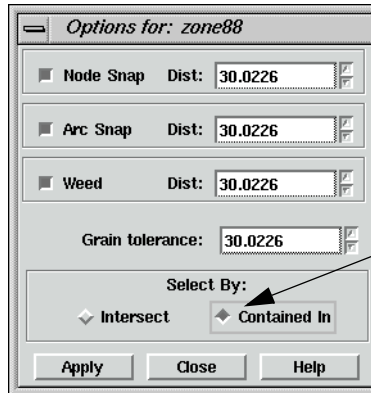

13. In the Options dialog under **Select By**, click **Contained In**.
14. Click **Apply** and then **Close** in the Options dialog.
15. In the menu bar of Viewer #1, select **Vector | Attributes**.

The Attributes dialog opens.

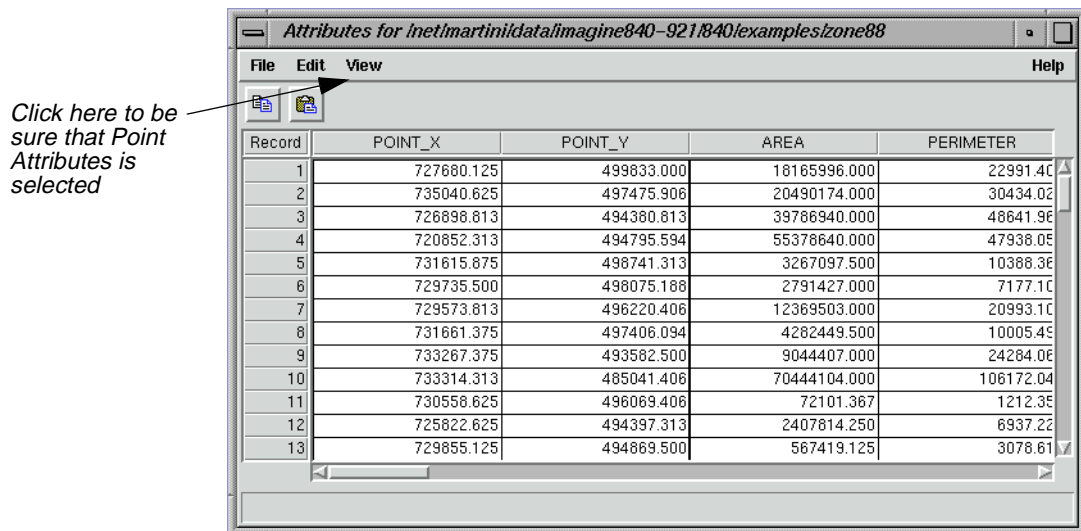

16. In the Attributes dialog menu bar, click on **View** and make sure that **Point Attributes** is selected.
17. In Viewer #1, click on the Zoom Out by 2 icon.



## Vector Querying and Editing

### Export Zoning Attributes

1. Click on the Ellipse Marquee icon in the Vector tool palette.



2. Shift-drag to draw a circle over the vector layer in Viewer #1.

The lines and points completely contained within the circle are selected in the Viewer and in the Attributes CellArray. You are going to export the **ZONING** attributes for the selected rows and import them into the new vector layer you are creating in Viewer #2.

3. Click the **ZONING** column header in the Attributes CellArray to select that column (use the bottom scroll bar to view the **ZONING** column).

The **ZONING** column is highlighted in green.

4. With your cursor in a column header of the Attributes CellArray, right-hold **Column Options | Export**.

The Export Column Data dialog opens.

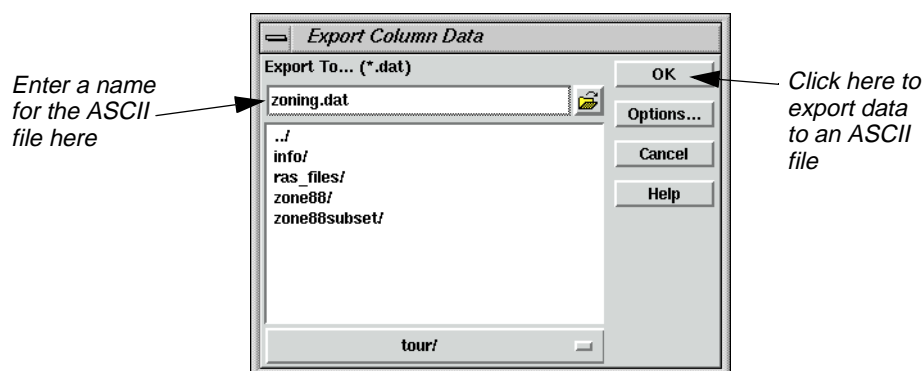

5. In the Export Column Data dialog, enter a name for the ASCII file you are creating, such as **zoning**. The .dat extension is added automatically.
6. Click **OK** in the Export Column Data dialog.
7. Select **Vector | Copy** from the Viewer #1 menu bar.

The selected lines and points are copied into the paste buffer.
8. Click anywhere in Viewer #2, then select **Vector | Paste** from the Viewer #2 menu bar.

The selected vectors are displayed in Viewer #2.
9. In Viewer #2, click outside of all lines and points of the vector layer to deselect everything.
10. In the Attributes dialog, select **File | Close**.

11. In the menu bar of Viewer #2, select **File | Save | Top Layer**.
12. In the menu bar of Viewer #2, select **Vector | Attributes**.

The Attributes dialog displays, but it is empty because this new layer has no attribute data. It must be cleaned or built. You can also create attributes using the **Edit | Create Attributes** option of the Attributes dialog. Use this method now, then run Build later.

### Create Attributes

1. In the Attributes dialog, select **View | Point Attributes** to select point attributes for display.
2. In the Attributes dialog, select **Edit | Create Attributes**.

The Attributes CellArray fills with the basic point attributes.

Next, you create a new column in the Attributes CellArray for the **ZONING** attribute that you exported from the original Attributes CellArray.

3. In the Attributes dialog, select **Edit | Column Attributes**.

The Column Attributes dialog opens.

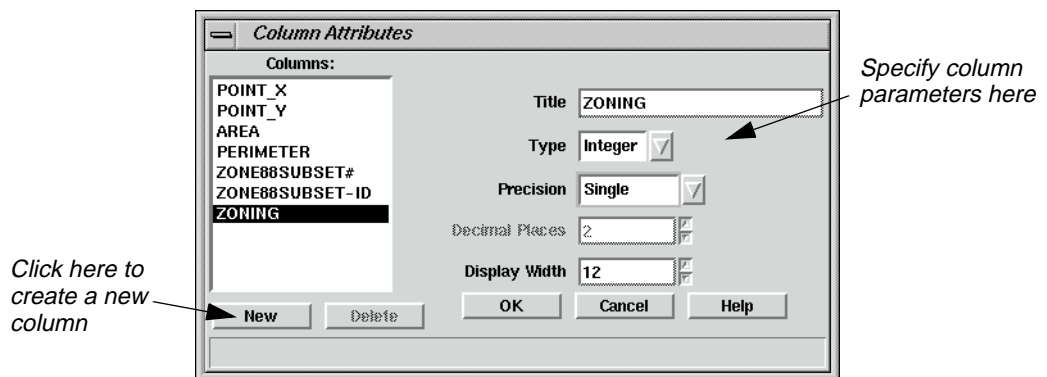

4. In the Column Attributes dialog, click **New** to add a new column to the CellArray.

The options on the right side of the dialog are now enabled, so that you can define the parameters of the new column.

5. For the column **Title**, enter **ZONING**. Press Return on your keyboard.
6. For **Type**, click on the popup list and select **Integer**.
7. For **Precision**, click on the popup list and select **Single**.
8. For **Display Width**, accept the default of **12**.
9. Click **OK** in the Column Attributes dialog to create the new column.



## Vector Querying and Editing

The Attributes CellArray now has a new column called **ZONING**. This new column is placed to the right of the last column.

10. Click in the header of this new column (**ZONING**) to select it.

The column is highlighted in blue.

11. With your cursor in the **Record** column, right-hold **Row Selection | Select All**.

12. With your cursor in a column header, right-hold **Column Options | Import**.

The Import Column Data dialog opens.

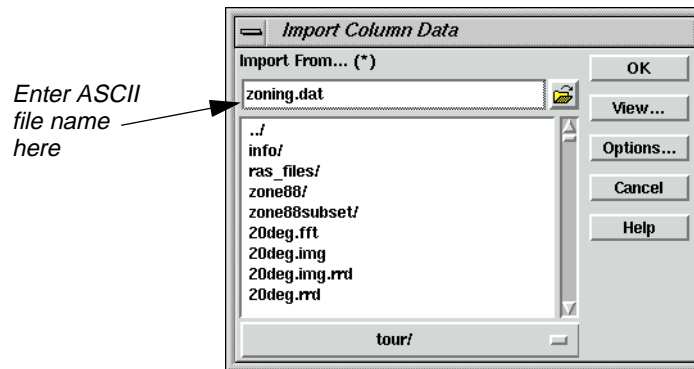

13. In the Import Column Data dialog, enter the name of the ASCII file that you created in the Export Column Data dialog in step 5. (i.e., **zoning.dat**).

14. Click **OK**.

The Attributes CellArray now has the same **ZONING** column and attributes as the original Attributes CellArray.

15. Select **File | Close** from the menu bar of Viewer #2. When asked if you would like to save changes, click **Yes**.

The Attributes dialog automatically closes.

### Create a Simple Shapefile Layer

1. Click the **Viewer** icon in the ERDAS IMAGINE icon panel.



A new Viewer opens.

2. In the new Viewer (Viewer #2) select **File | Open | Raster Layer**.



The Select Layer To Add dialog opens.

3. In the Select Layer To Add dialog, select **IMAGINE Image** from the **File Type** popup list.
4. Under **Filename**, click on the file **germtm.img**.
5. Click on the **Raster Options** tab at the top of the dialog and confirm that the **Fit to Frame** option is enabled.
6. Click **OK** in the Select Layer To Add dialog.

The file **germtm.img** displays in the Viewer.

7. With your cursor in the Viewer, right-hold **Quick View | Zoom | Rotate and Magnify Area**.

A white rotation box displays in the Viewer and a Rotate/Magnify Instructions box also displays.

8. Drag the white rotation box so that it is positioned over the same area that was covered by the zone88 vector coverage. Double-click within the rotation box to magnify that area.

The Rotate/Magnify Instructions box dismisses and the raster layer is magnified in the Viewer.



---

*For other methods of zooming into an area of interest, see "Animated Zoom", "Box Zoom", and "Real-time Zoom", starting on page 18.*

9. In the Viewer #2 menu bar, select **File | New | Vector Layer**.

The New Vector Layer dialog opens.

10. Under **File of Type**, select **Shapefile (\*.shp)** from the pulldown list.
11. In the New Vector Layer dialog under **Vector Layer**, enter a name for the new layer, such as **zone88shapefile**, in the directory of your choice.



---

*Vector coverages include Arc Coverage, SDE Vector Layer, and Shapefile.*

12. Click **OK** in the New Vector Layer dialog.

The New Shapefile Layer Option dialog opens.

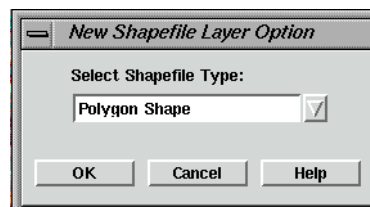

13. Select **Polygon Shape** from the pulldown list.
14. Click **OK** in the New Shapefile Layer Options dialog.



# Vector Querying and Editing

## Create a Shapefile Coverage

1. In the Viewer tool bar, click the Tools icon (or select **Vector | Tools** from the Viewer menu bar).



The Vector tool palette displays



2. In the Vector tool palette, click on the Polygon tool.



*For more information on using the Shapefile editing tools, see the Vector Tools Diagram page in the Vector On-Line Manual.*

3. Using the Inquire Cursor, find the triangular field at X: 726102.951800, Y: 497901.936911.
4. Left-click at the north end of the field and begin digitizing a shapefile coverage of the field.

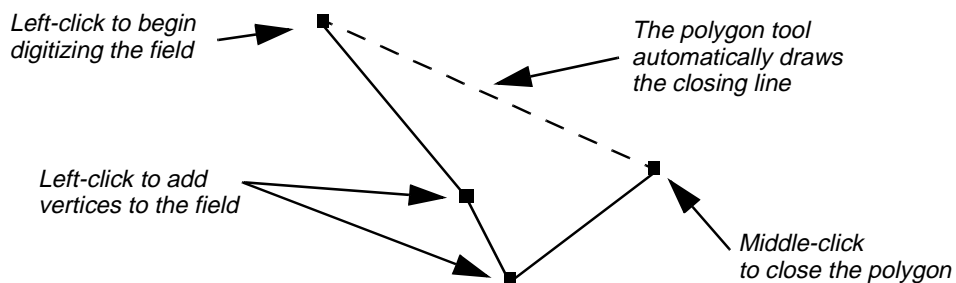

Your polygon should look something like this:



*NOTE: The raster layer of these images have been washed out for the purposes of illustration.*

5. Open the Vector Attributes table by selecting **Vector | Attributes** from the Viewer menu bar or by clicking on the **Vector Attributes** button in the Vector Tool palette.



6. The Vector Attributes table displays:

Record	AREA	PERIMETER	ID
1	4375505.629	11192.683	1

### Editing the Shapefile Layer

7. To divide this polygon into two polygons, select the **Polygon Split** tool from the Vector Tools palette.



## Vector Querying and Editing

- Left-click once just outside the left side of the polygon. Move your cursor across the middle and outside of the right side of the polygon so that the split line divide the polygon into no more than two parts. It should look similar to this:

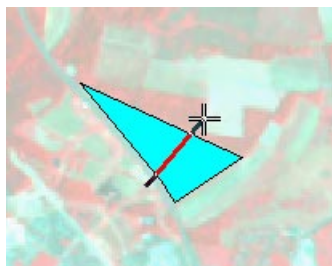

- Middle-click to end the split line. The polygon has split into two polygons and should look like this:

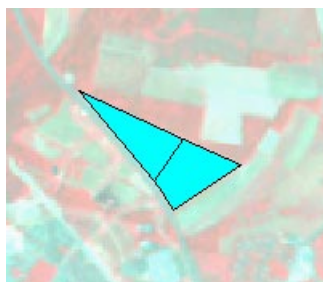

- Notice that the Area and Perimeter columns were automatically updated in the Vector Attributes table:

Record	AREA	PERIMETER	ID
1	2191738.358	7767.290	1
2	2183767.270	6259.783	1

- Next you will create a new polygon that shares a common border with an existing polygon. To do this, select the Append Polygon tool from the Vector tools palette.



12. To begin digitizing the field below the original polygon, left-click *Inside* of the existing polygon. Continue to left-click to add vertices until you have digitized the entire field. Your line should end up within the same polygon in which you started and look like this:

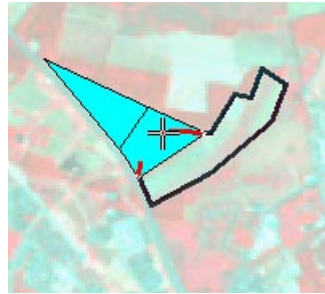

13. Double-click to close the polygon. The new polygon should look like this:

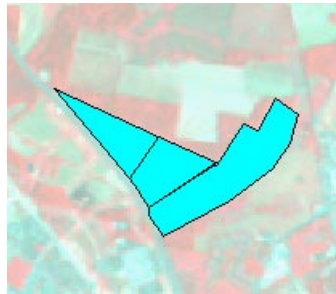

14. Again note that the columns in the Vector Attributes Table update to show the area and perimeter of the new polygon.

Record	AREA	PERIMETER	ID
1	2191738.358	7767.290	1
2	2183767.270	6259.783	1
3	4727212.304	11608.438	6

15. Next you will reshape this polygon so that it contains more of the field. To do this, you will need to select the Replace Polygon tool from the Vector tools palette.



## Vector Querying and Editing

16. Again, start your digitizing by left-clicking inside of the polygon you want to replace. Continue left-clicking to add vertices to the polygon. Your line should end up within the same polygon in which you started and look similar to this:

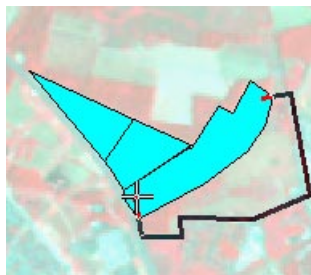

17. Double-click inside of the starting polygon to reshape the existing polygon to include the newly digitized area. Your new polygon should look like this:

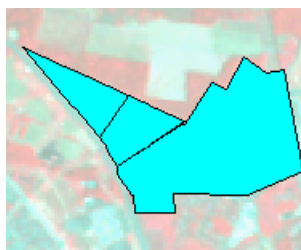

18. The Area and Perimeter values in the Vector Attributes table reflect the dimensions of the polygon:

A screenshot of a software dialog box titled "Attributes for /home/jay1017/zone88shapefile.shp". The dialog has a menu bar with "File", "Edit", "View", and "Help". Below the menu bar are two icons: a document with a magnifying glass and a document with a pencil. The main area contains a table with four columns: "Record", "AREA", "PERIMETER", and "ID".

Record	AREA	PERIMETER	ID
1	2191738.358	7767.290	1
2	2183767.270	6259.783	1
3	10518786.372	15159.351	1

19. Click **File | Close** from the Viewer menu bar. When asked if you would like to save your changes, click **Yes**.

The Attributes dialog automatically closes.



*For more information about IMAGINE Vector, see "APPENDIX A: Additional Information" on page 595.*

# CHAPTER 6

## Polynomial Rectification

---

### Introduction

Rectification is the process of projecting the data onto a plane and making it conform to a map projection system. Assigning map coordinates to the image data is called georeferencing. Since all map projection systems are associated with map coordinates, rectification involves georeferencing.



---

*Approximate completion time for this tour guide is 1 hour.*

---

### Rectify a Landsat Image

#### Perform Image to Image Rectification

In this tour guide, you rectify a Landsat TM image of Atlanta, Georgia, using a georeferenced SPOT panchromatic image of the same area. The SPOT image is rectified to the State Plane map projection.

In rectifying the Landsat image, you use these basic steps:

- display files
- start Geometric Correction Tool
- record GCPs
- compute a transformation matrix
- resample the image
- verify the rectification process

#### Display Files

First, you display the image to be rectified and an image that is already georeferenced.

#### Prepare

ERDAS IMAGINE must be running and a Viewer open.

1. Click the Viewer icon on the ERDAS IMAGINE icon panel to open a second Viewer.



The second Viewer displays on top of the first Viewer.



## Polynomial Rectification

2. In the ERDAS IMAGINE menu bar, select **Session | Tile Viewers** to position the Viewers side by side.
3. In the first Viewer's tool bar, click the Open icon (or select **File | Open | Raster Layer**).



The Select Layer To Add dialog opens.

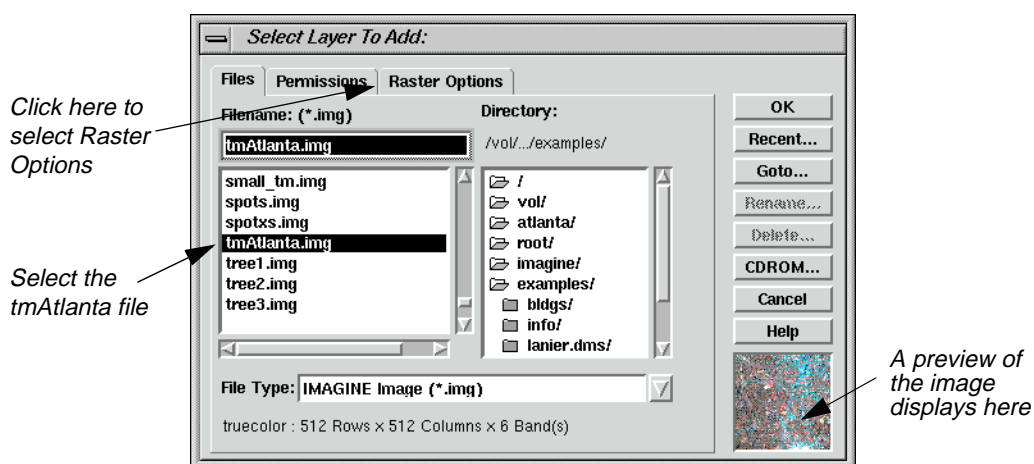

4. In the Select Layer To Add dialog under **Filename**, click on the file **tmAtlanta.img**.

This file is a Landsat TM image of Atlanta. This image has not been rectified.

5. Click the **Raster Options** tab at the top of the Select Layer To Add dialog.



The Raster Options display in the Select Layer To Add dialog.

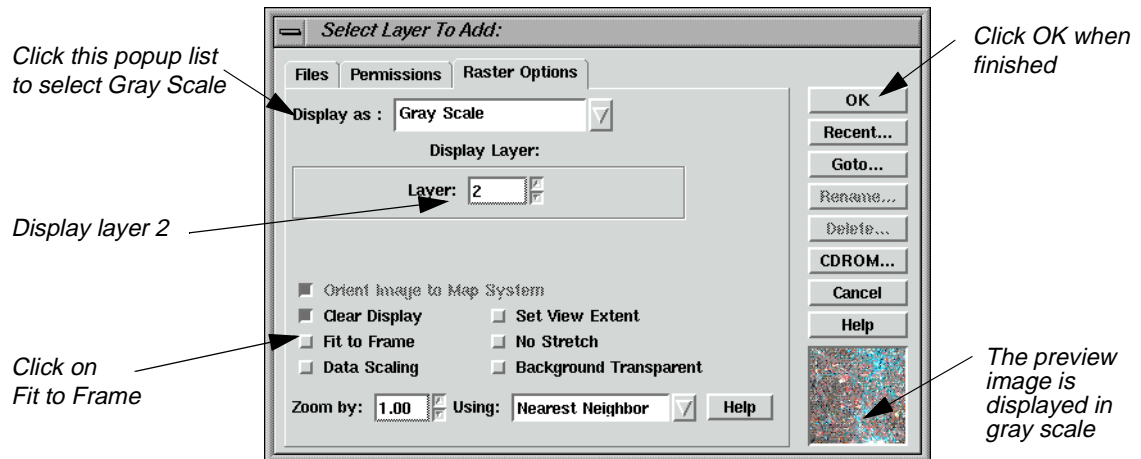

6. Click the **Display as** popup list and select **Gray Scale**.

7. Under **Display Layer**, enter **2**.

Depending upon your application, it may be easier to select GCPs from a single band of imagery. The image **tmAtlanta.img** displays in **True Color** by default.

8. Click **Fit to Frame**, so that the entire image is visible in the Viewer.

9. Click **OK** in the Select Layer To Add dialog.

The file **tmAtlanta.img** displays in the first Viewer.

10. In the second Viewer tool bar, click the Open icon (or select **File | Open | Raster Layer**).

The Select Layer To Add dialog opens.

11. In the Select Layer To Add dialog, click on the file **panAtlanta.img**.

This file is a SPOT panchromatic image of Atlanta. This image has been georeferenced to the State Plane map projection.

12. Click **OK** in the Select Layer To Add dialog.

The file **panAtlanta.img** displays in the second Viewer.

## Start GCP Tool

You start the Geometric Correction Tool from the first Viewer—the Viewer displaying the file to be rectified (**tmAtlanta.img**).

1. Select **Raster | Geometric Correction** from the first Viewer's menu bar.

The Set Geometric Model dialog opens.

# Polynomial Rectification

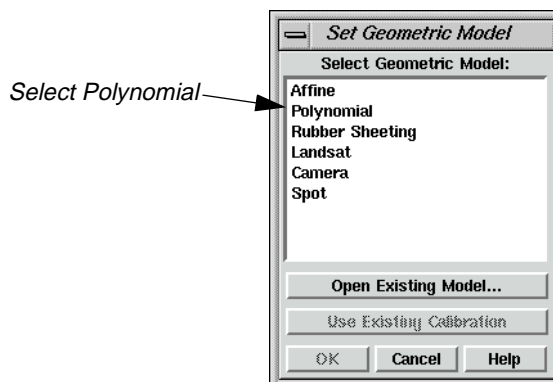

2. In the Set Geometric Model dialog, select **Polynomial** and then click **OK**.

The Geo Correction Tools open, along with the Polynomial Model Properties dialog.

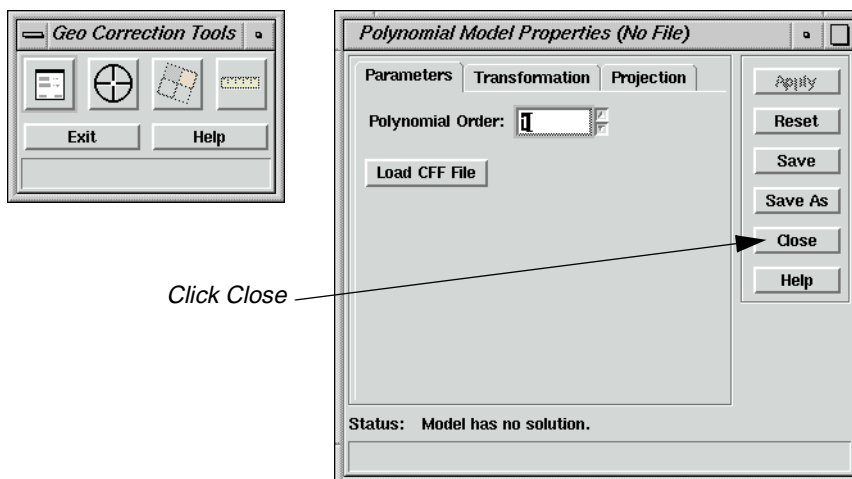

3. Click **Close** in the Polynomial Model Properties dialog to close it for now. You select these parameters later.

The GCP Tool Reference Setup dialog opens.

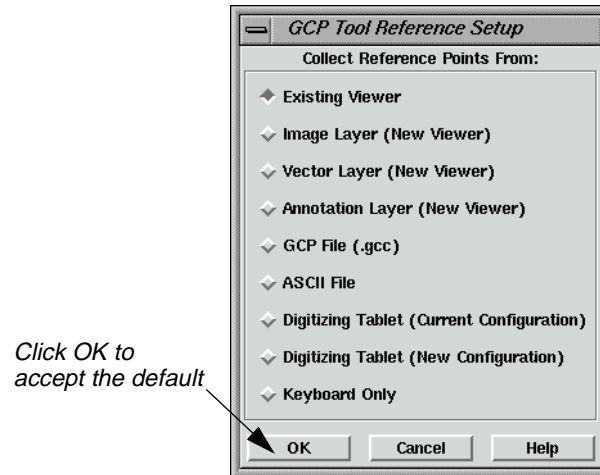

4. Accept the default of **Existing Viewer** in the GCP Tool Reference Setup dialog by clicking **OK**.

The GCP Tool Reference Setup dialog closes and a Viewer Selection Instructions box opens, directing you to click in a Viewer to select for reference coordinates.

5. Click in the second Viewer, which displays **panAtlanta.img**.

The Reference Map Information dialog opens showing the map information for the georeferenced image. The information in this dialog is not editable.

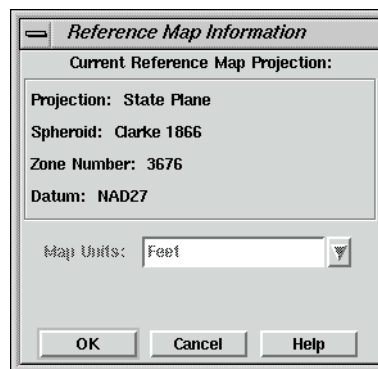

6. Click **OK** in the Reference Map Information dialog.



# Polynomial Rectification

The Chip Extraction Viewers (Viewers #3 and #4), link boxes, and the GCP Tool open. The link boxes and GCP Tool are automatically arranged on the screen (you can turn off this option in the ERDAS IMAGINE Preferences). You may want to resize and move the link boxes so that they are easier to see.

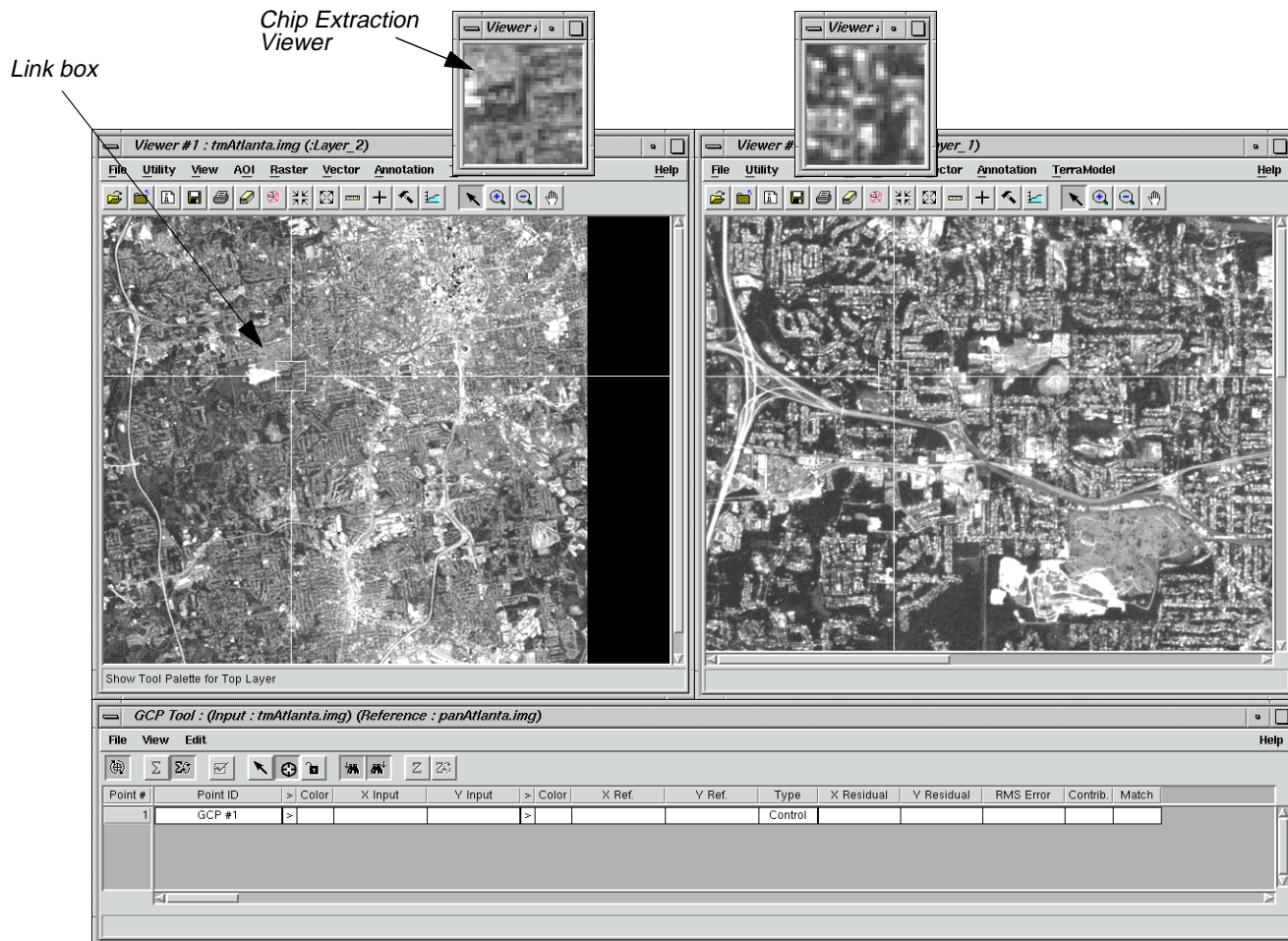

In this tour guide, you are going to rectify **tmAtlanta.img** in the first Viewer to **panAtlanta.img** in the second Viewer.

## Select GCPs

When the GCP Tool is started, the tool is set in Automatic GCP Editing mode by default.

The following icon is active, indicating that this is the case.



## Rectify a Landsat Image

1. In the first Viewer, select one of the areas shown in the following picture by clicking on that area. The circled areas are locations for GCPs. You should choose points that are easily identifiable in both images, such as road intersections and landmarks.

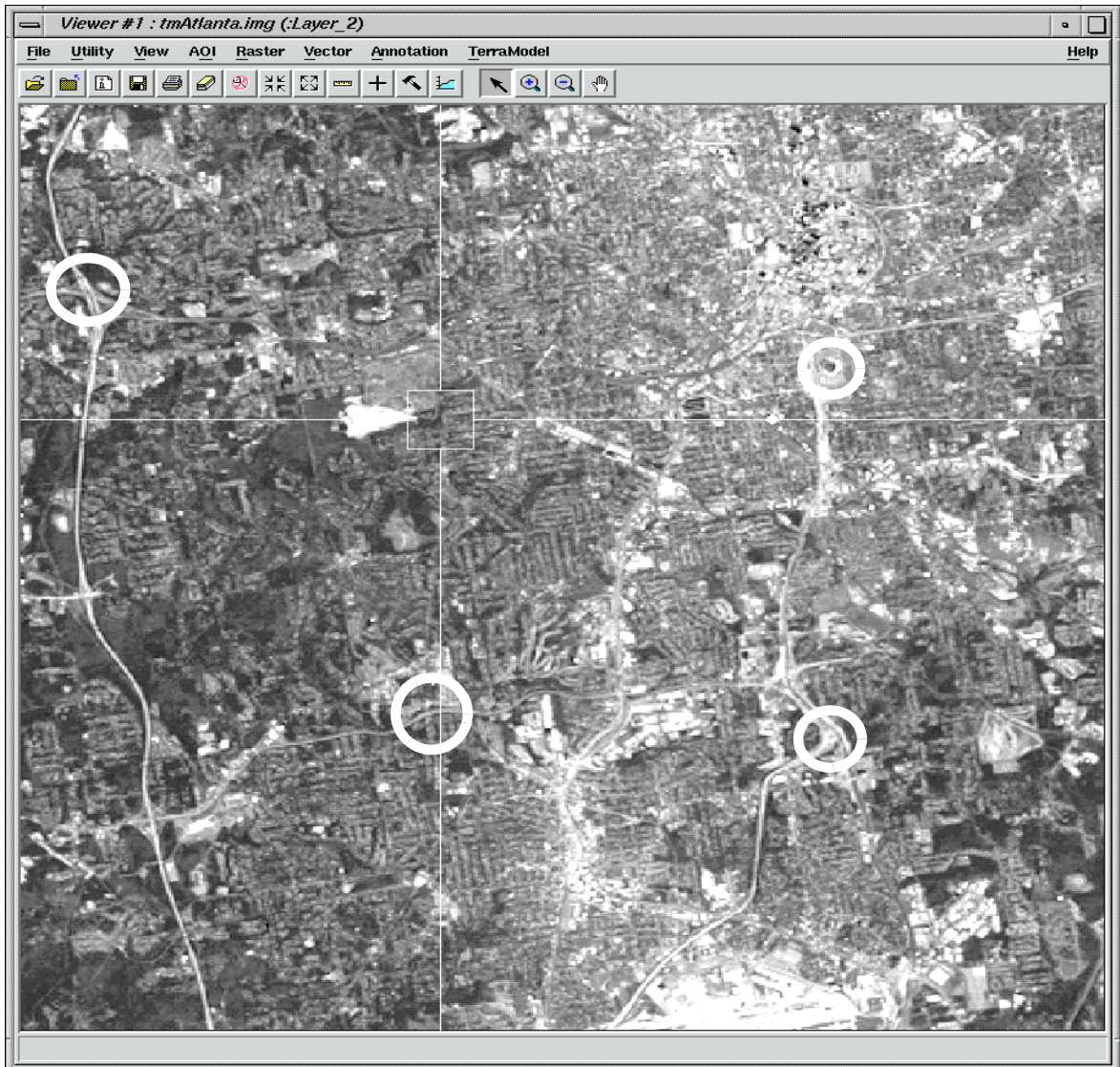

The point you have selected is marked as GCP #1 in the Viewer and its X and Y inputs are listed in the GCP Tool CellArray.

2. In order to make GCP #1 easier to see, right-hold in the **Color** column to the right of GCP #1 in the GCP Tool CellArray and select the color **Black**.
3. In Viewer #3 (the Chip Extraction Viewer associated with the first Viewer), drag the GCP to the exact location you would like it to be.



## Polynomial Rectification

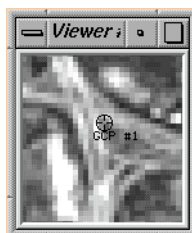

*NOTE: (UNIX only) To view the GCP while you are dragging it, turn off the **Use Fast Selectors** checkbox in the **Viewer** category under **Session | Preferences** (this change does not take effect until the Viewer is restarted).*

4. In the GCP Tool, click on the Create GCP icon.



5. In the second Viewer, click in the same area that is covered in the source Chip Extraction Viewer (Viewer #3).

The point you have selected is marked as GCP #1 in the Viewer, and its X and Y coordinates are listed in the GCP Tool CellArray.

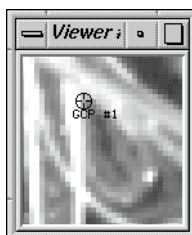

6. In order to make GCP #1 easier to see in the second Viewer, right-hold in the **Color** column to the left of the X reference for GCP #1 in the GCP Tool CellArray and select the color **Black**.

The GCP Tool should now look similar to the one pictured below:

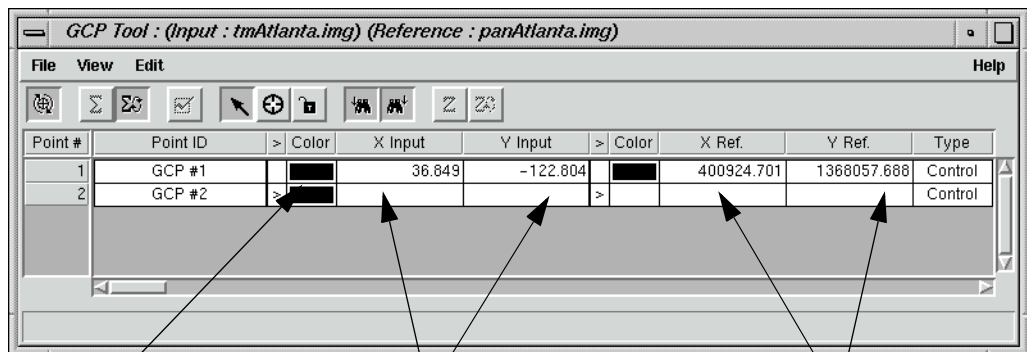

Select the color for the source GCP here

These are the X and Y file coordinates for GCPs in the input image (tmAtlanta.img)

These are the X and Y map coordinates for GCPs in the reference image (panAtlanta.img)

7. In Viewer #4 (the Chip Extraction Viewer associated with the second Viewer), drag the GCP to the same location you moved it to in Viewer #3.
8. Click on the Create GCP icon in the GCP tool bar.
9. Return to the source Viewer (the first Viewer) and click to digitize another GCP.
10. In order to make GCP #2 easier to see, right-hold in the **Color** column to the right of GCP #2 in the GCP Tool CellArray and select the color **Magenta**.
11. In Viewer #3, drag the new GCP (GCP #2) to the exact location you would like it to be.
12. Repeat steps (4. and 5. to digitize the same point in the second Viewer).
13. As in step 10., you can change the color of the GCP marker to make it easier to see.
14. Digitize at least two more GCPs in each Viewer (on **tmAtlanta.img** in the first Viewer and **panAtlanta.img** in the second Viewer) by repeating the above steps. The GCPs you digitize should be spread out across the image to form a large triangle (i.e., they should not form a line).
15. Choose colors that enable you to see the GCPs in the Viewers.

After you digitize the fourth GCP in the first Viewer, note that the GCP is automatically matched in the second Viewer. This occurs with all subsequent GCPs that you digitize.

After you digitize GCPs in the Viewers, the GCP Tool CellArray should look similar to the following example:



# Polynomial Rectification

Point #	Point ID	> Color	X Input	Y Input	> Color	X Ref.	Y Ref.	Type
1	GCP #1	> [Black]	36.849	-122.804	> [Black]	400924.701	1368057.688	Control
2	GCP #2	> [Magenta]	382.033	-144.293	> [Magenta]	432235.059	1360264.895	Control
3	GCP #3	> [Magenta]	169.534	-343.831	> [Magenta]	409331.886	1345481.938	Control
4	GCP #4	> [Magenta]	377.599	-360.544	> [Magenta]	428210.054	1340501.007	Control
5	GCP #5	> [Magenta]			> [Magenta]			Control

## Selecting GCPs

Selecting GCPs is useful for moving GCPs graphically or deleting them. You can select GCPs graphically (in the Viewer) or in the GCP CellArray.

- To select a GCP graphically in the Viewer, use the Select icon.



Select it as you would an annotation element. When a GCP is selected, you can drag it to move it to the desired location.

You can also click on any GCP coordinate in the CellArray to enter new coordinates.

- To select GCPs in the CellArray, click in the **Point #** column, or use any of the CellArray selection options in the right mouse button menu (right-hold in the **Point #** column).

## Deleting a GCP

To delete a GCP, select the GCP in the CellArray in the GCP Tool and then right-hold in the **Point #** column to select **Delete Selection**.



### Compute Transformation Matrix

A transformation matrix is a set of numbers that can be plugged into polynomial equations. These numbers are called the transformation coefficients. The polynomial equations are used to transform the coordinates from one system to another.

The **Transformation** tab in the Polynomial Model Properties dialog shows you a scrolling list of the transformation coefficients arranged in the transformation matrix. To access the Polynomial Model Properties dialog and the **Transformation** tab, click the Display Model Properties icon in the Geo Correction Tools.



The coefficients are placed in the transform editor in two ways:

- the **Transformation** tab CellArray is automatically populated when the model is solved in the GCP Tool
- using the CellArray located in the GCP tool to enter them directly from the keyboard.

In this tour guide, the transformation coefficients are calculated from the GCP Tool, and are automatically recorded in the **Transformation** tab.

### Preparation

A minimum number of GCPs is necessary to calculate the transformation, depending on the order of the transformation. This number of points is:

$$\frac{(t+1)(t+2)}{2}$$

Where  $t$  is the order of the transformation.

If the minimum number of points is not satisfied, then a message displays notifying you of that condition, and the RMS errors and residuals are blank. At this point, you are not allowed to resample the data.

### Change Order of Transformation

To change the order of the transformation, use the Polynomial Model Properties dialog (available from the Geo Correction Tools). Using this dialog, select the **Parameters** tab at the top of the dialog. This tab allows the polynomial order to be altered.



# Polynomial Rectification

## Calculate Transformation Matrix from GCPs

### Start Automatic Transform Calculation

The Auto Calculation function is enabled by default in the GCP Tool. The Auto Calculation function computes the transformation in real time as you edit the GCPs or change the selection in the CellArray.

With the Automatic Transform Calculation tool activated, you can move a GCP in the Viewer while watching the transformation coefficients and errors change at the top of the GCP Tool.

You may want to turn off the Auto Calculation function if your system or computation is taking too long.

*NOTE: Some models do not support Auto Calculation. If this is the case, the function is disabled.*

1. If your model does not support Auto Calculation, click on the Calculate icon in the GCP Tool tool bar.



*NOTE: The transformation matrix contains the coefficients for transforming the reference coordinate system to the input coordinate system. Therefore, the units of the residuals and RMS errors are the units of the input coordinate system. In this tour guide, the input coordinate system is pixels.*

## Digitize Check Points

Check points are useful in independently checking the accuracy of your transformation.

2. In the GCP Tool, turn all of the GCPs to yellow by right-holding **Select All** in the **Point #** column and then right-holding **Yellow** in each of the two **Color** columns.
3. Right-hold **Select None** in the **Point #** column of the GCP Tool CellArray to deselect the GCPs.
4. In the last row of the CellArray, right-hold in each of the two **Color** columns and select **Magenta**.

All of the check points you add in the next steps are Magenta, which distinguishes them from the GCPs.

5. Select the last row of the CellArray by clicking in the **Point #** column next to that row.
6. Select **Edit | Set Point Type | Check** from the GCP Tool menu bar.

All of the points you add in the next steps are classified as check points.

7. Select **Edit | Point Matching** from the GCP Tool menu bar.

The GCP Matching dialog opens.

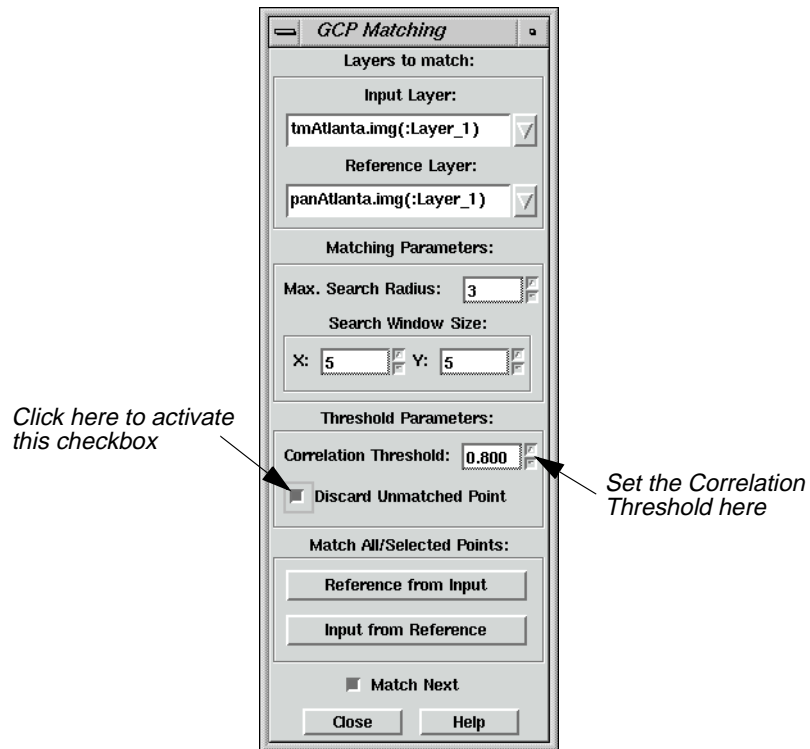

8. In the GCP Matching dialog under **Threshold Parameters**, change the **Correlation Threshold** to **.8**, and then press the Return key on your keyboard.

9. Click the **Discard Unmatched Point** checkbox to activate it.

10. Click **Close** in the GCP Matching dialog.

11. In the GCP Tool, click the Create GCP icon and then the Lock icon.

12. Create 5 check points in each of the two Viewers, just as you did for the GCPs.

*NOTE: If the previously input points were not accurate, then the check points you designate may go unmatched and be automatically discarded.*

13. When the 5 check points have been created, click the Lock icon in the GCP Tool to unlock the Create GCP function.

14. Click the Compute Error icon in the GCP Tool to compute the error for the check points.



The **Check Point Error** displays at the top of the GCP Tool. A total error of less than 1 pixel error would make it a reasonable resampling.

# Polynomial Rectification

15. To view the polynomial coefficients, click the Model Properties icon in the Geo Correction Tools.



The Polynomial Model Properties dialog opens.

16. Once you have checked the tabs of the Polynomial Model Properties dialog, click **Close** in the Polynomial Properties dialog.

## Resample the Image

Resampling is the process of calculating the file values for the rectified image and creating the new file. All of the raster data layers in the source file are resampled. The output image has as many layers as the input image.

ERDAS IMAGINE provides these widely-known resampling algorithms: Nearest Neighbor, Bilinear Interpolation, and Cubic Convolution

### Prepare

Resampling requires an input file and a transformation matrix by which to create the new pixel grid.

1. Click on the Resample icon in the Geo Correction Tools.



The Resample dialog opens.

The screenshot shows the 'Resample' dialog box with the following fields and annotations:

- Output File: (\*.img)**: *tmAtlanta\_georef.img* (Annotation: *Enter file name for the new georeferenced image file*)
- Resample Method:**: Bilinear Interpolation (Annotation: *Click here to select the Bilinear Interpolation resampling method*)
- Output Map Information:**
  - Projection:** State Plane (Annotation: *Output map projection should be State Plane*)
  - Units:** feet
  - Number rows:** 511
  - Number columns:** 511
- Output Corners:**
  - ULX: 390983.000000
  - LRX: 446573.000000
  - ULY: 1379948.000000
  - LRY: 1324358.000000
- Output Cell Sizes:**
  - X: 109.000000
  - Y: 109.000000
- Ignore Zero in Stats.**:  (Annotation: *Click here to exclude zero file values in statistics for output file*)
- Buttons: OK, Batch, Cancel, Help

2. In the Resample dialog under **Output File**, enter the name **tmAtlanta\_georef.img** for the new resampled data file. This is the output file from rectifying the **tmAtlanta.img** file to the coordinate system of the **panAtlanta.img** file.

*NOTE: Be sure to enter the output file in a directory where you have write permission and at least 25 Mb of free disk space.*

3. Under **Resample Method**, click the popup list and select **Bilinear Interpolation**.
4. Click **Ignore Zero in Stats.**, so that pixels with zero file values are excluded when statistics are calculated for the output file.
5. Click **OK** in the Resample dialog to start the resampling process.

A Job Status dialog opens to let you know when the processes complete.

6. Click **OK** in the Job Status dialog when the job is 100% complete.

### Verify the Rectification Process

One way to verify that the input image (**tmAtlanta.img**) has been correctly rectified to the reference image (**panAtlanta.img**) is to display the resampled image (**tmAtlanta\_georef.img**) and the reference image and then visually check that they conform to each other.

1. Display the resampled image (**tmAtlanta\_georef.img**) in the first Viewer. Use the **Clear Display** option in the Select Layer To Add dialog to remove **tmAtlanta.img** from the Viewer before the resampled image is opened.

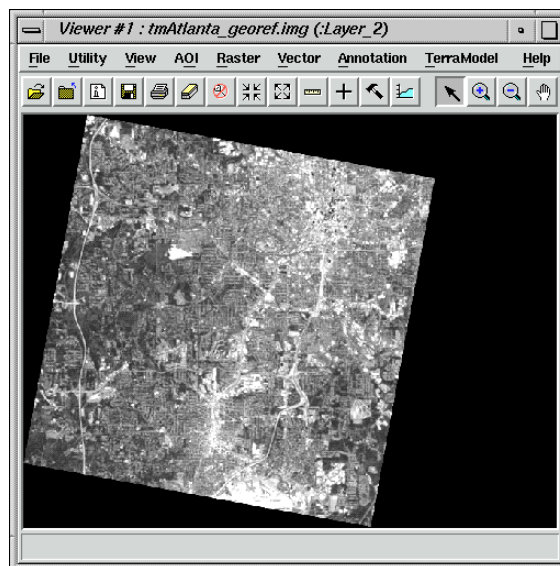

2. When **tmAtlanta.img** closes in the first Viewer, you are asked if you want to save your changes. Click **No** in all of the Save Changes dialogs.

The Geometric Correction Tool exits.

3. Right-hold **Geo. Link/Unlink** under the **Quick View** menu in the first Viewer.



# Polynomial Rectification

4. Click in the second Viewer to link the Viewers together.
5. Right-hold **Inquire Cursor** under the **Quick View** menu in the first Viewer.

The inquire cursor (a crosshair) is placed in both Viewers. An Inquire Cursor dialog also opens.

6. Drag the inquire cursor around to verify that it is in approximately the same place in both Viewers. Notice that, as the inquire cursor is moved, the data in the Inquire Cursor dialog are updated.
7. When you are finished, click **Close** in the Inquire Cursor dialog.

## Rotate/Flip/Stretch Images

It is often necessary to perform a first-order rectification to a layer displayed in the Viewer. You may need to rotate, flip, or stretch the image so that North is up.

### Prepare

1. Display the file **tmAtlanta.img** in a Viewer.
2. In the Viewer, select **Raster | Geometric Correction**.

The Set Geometric Model dialog opens.

### Choose Model Properties

3. In the Set Geometric Model dialog, click **Affine** and then **OK**.

The Geo Correction Tools open, along with the Affine Model Properties dialog.

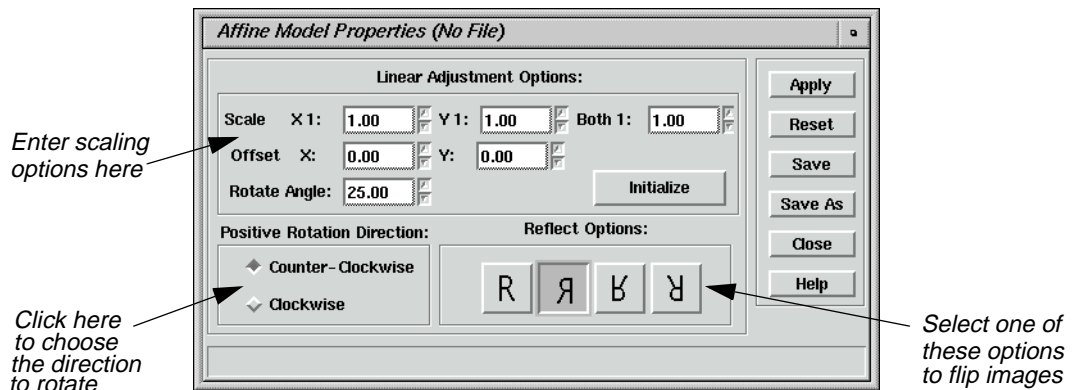

4. Change the **Rotate Angle** to **25**.
5. Select the desired **Reflect Option** in the Affine Model Properties dialog, then click **Apply** and **Close**.
6. Click on the Resample icon in the Geo Correction Tools.



The Resample dialog opens.

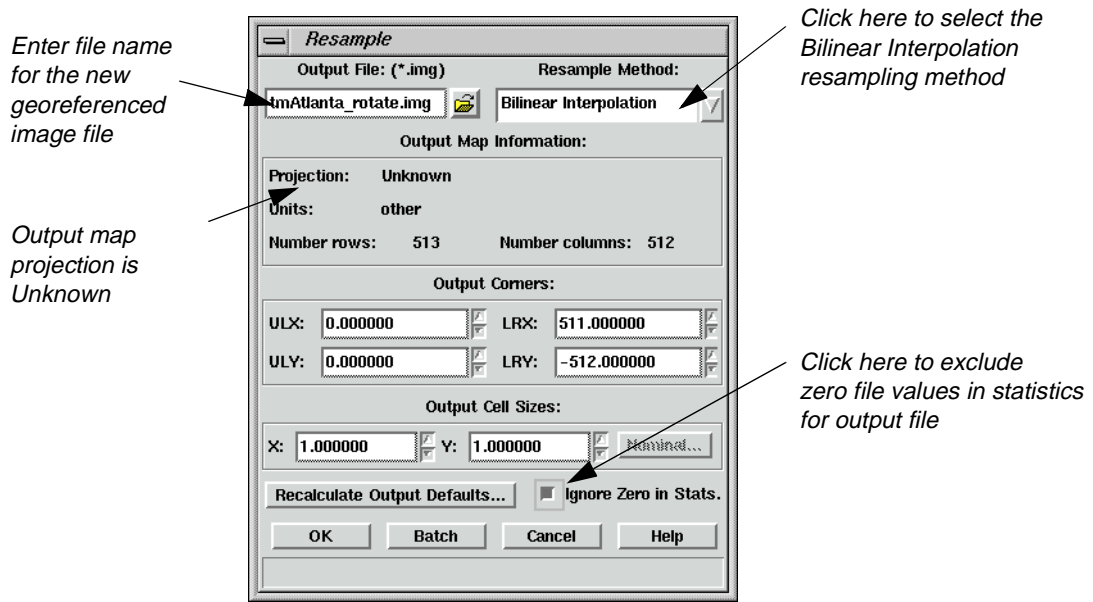

7. In the Resample dialog under **Output File**, enter the name **tmAtlanta\_rotate.img**.
8. Under **Resample Method**, click the popup list and select **Bilinear Interpolation**.
9. Click **Ignore Zero in Stats.**, so that pixels with zero file values are excluded when statistics are calculated for the output file.
10. Click **OK** in the Resample dialog to start the resampling process.

A Job Status dialog opens to let you know when the processes complete.

11. Click **OK** in the Job Status dialog when the job is 100% complete.

### Check Results

1. Open a new Viewer.
2. Click the Open icon, then select **tmAtlanta\_rotate.img** from the directory in which you saved it.
3. Click the **Raster Options** tab, and click the **Display as** dropdown list to select **Gray Scale**.
4. In the **Display Layer** section, select **Layer 2**.
5. Click **OK** in the Select Layer To Add dialog.



# Polynomial Rectification

6. Compare **tmAtlanta\_georef.img** and **tmAtlanta\_rotate.img** side by side.

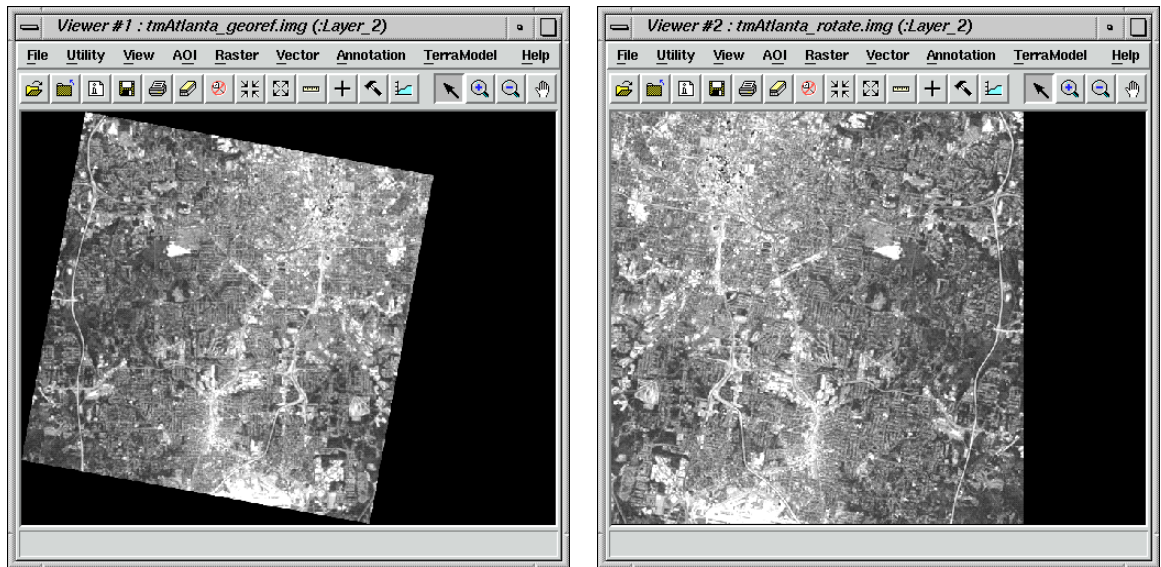

*For more information about polynomial rectification, see "APPENDIX A: Additional Information" on page 595.*



# CHAPTER 7

## Image Commands

### Introduction

ERDAS IMAGINE gives you access to a tool called the Image Commands tool. With it, you can take any file supported by ERDAS IMAGINE and perform many types of operations. One such operation is using the Image Commands tool to create a world file. You can then use the world file with other software packages, such as ESRI's ArcView.

In this tour guide, you can learn how to:

- access the Image Commands tool
- create a world file from a .tif file



*Approximate completion time for this tour guide is 15 minutes.*

### Image Commands

With the Image Commands tool, you can make many changes to your files.

#### Prepare

ERDAS IMAGINE must be running

#### Use Image Interpreter Utilities

1. Click the Interpreter icon on the ERDAS IMAGINE icon panel.

The **Image Interpreter** menu opens.

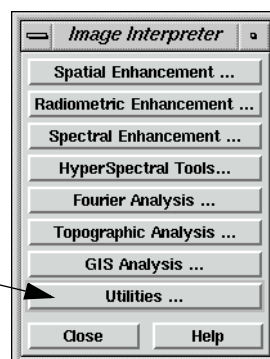

*Click the Utilities option*

2. Click **Utilities** in the **Image Interpreter** menu.

The **Utilities** menu opens.



# Image Commands

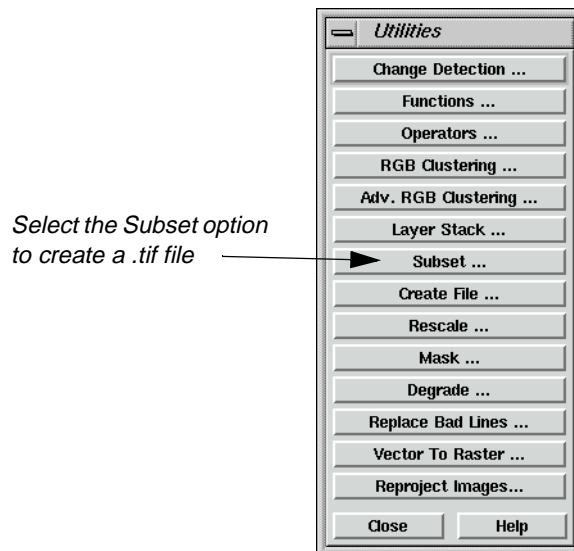

## Use the Subset Function

1. In the **Utilities** menu, select **Subset**.

The Subset dialog opens.

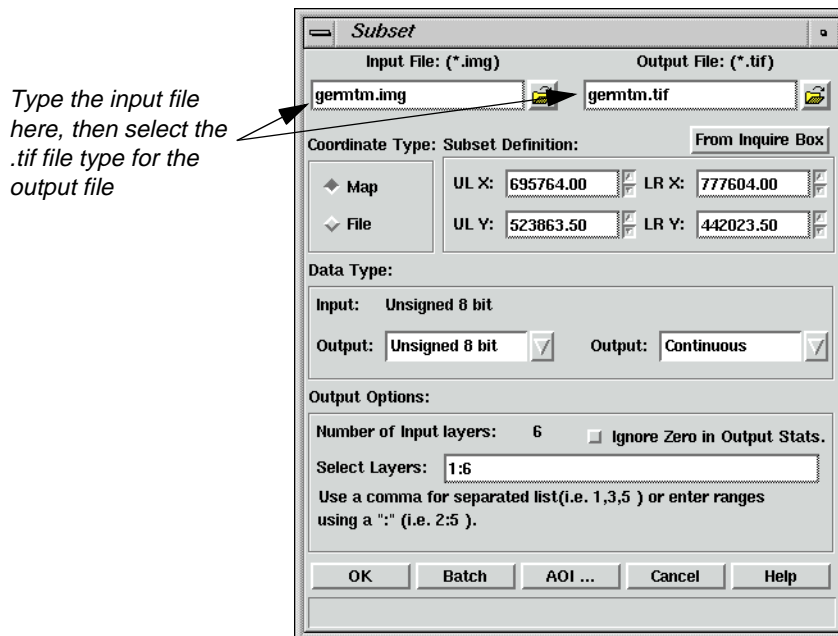

2. In the Subset dialog, click the Open icon below **Input File**.



3. In the Input File dialog, navigate to the <IMAGINE\_HOME>/examples directory, and select the file **germtm.img**.
4. Click **OK** in the Input File dialog to transfer **germtm.img** to the Subset dialog.
5. Click the Open icon under **Output File**.
6. In the Output File dialog, navigate to a directory where you have write permission.
7. Click the **File Type** dropdown list and choose **TIFF**.
8. Type the name **germtm** in the **Filename** window, then press Return on your keyboard.

The .tif extension is automatically added. By using the Subset utility in this fashion, you can quickly create a TIFF image from an image file.

9. Click **OK** in the Output File dialog.

The Subset file updates accordingly.

10. Click **OK** in the Subset dialog to generate **germtm.tif**.

A Job Status dialog opens, tracking the progress of the function.

11. When the Job is complete, click **OK** in the Job Status dialog.



---

*You can set a preference in the **User Interface & Session** category to automatically dismiss the Job Status dialog once a job is complete.*

### Check the TIFF file

1. Click the Viewer icon on the ERDAS IMAGINE icon panel.



2. Click the Open icon, and click the **Recent** button in the Select Layer To Add dialog.
3. Select the file you just created, **germtm.tif**.
4. Click the **Raster Options** tab, and select **Fit to Frame**.
5. Click **OK** in the Select Layer to Add dialog.



# Image Commands

The TIFF image displays in the Viewer. Notice that it is in the State Plane projection, indicated in the status area of the Viewer.

You can create a world file from this .tif file

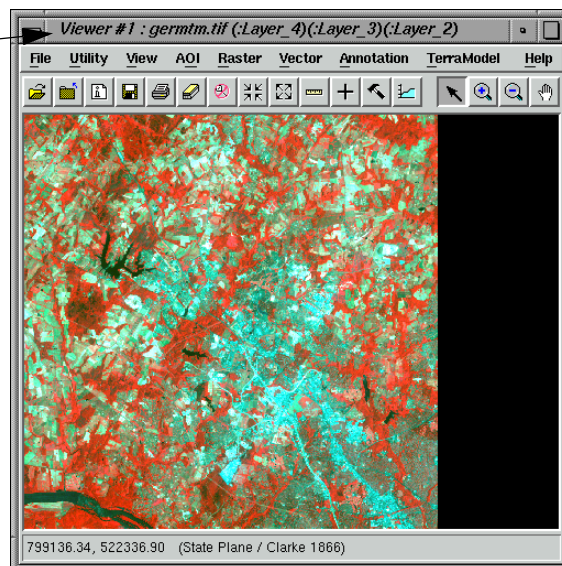

Now, you can take the file **germtm.tif** and create a world file using the Image Command Tool.

## Start the Image Command Tool

1. From the **Tools** menu of ERDAS IMAGINE, select **Image Command Tool**.

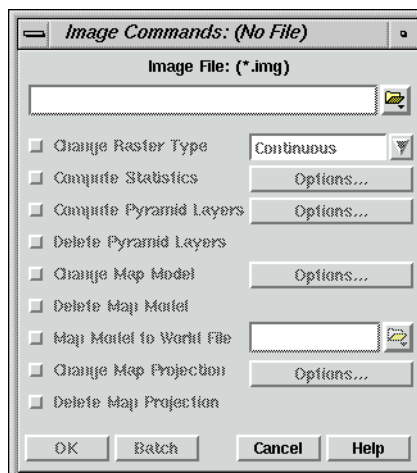

- In the Image Commands dialog, click the Open icon.



The Image File dialog opens.

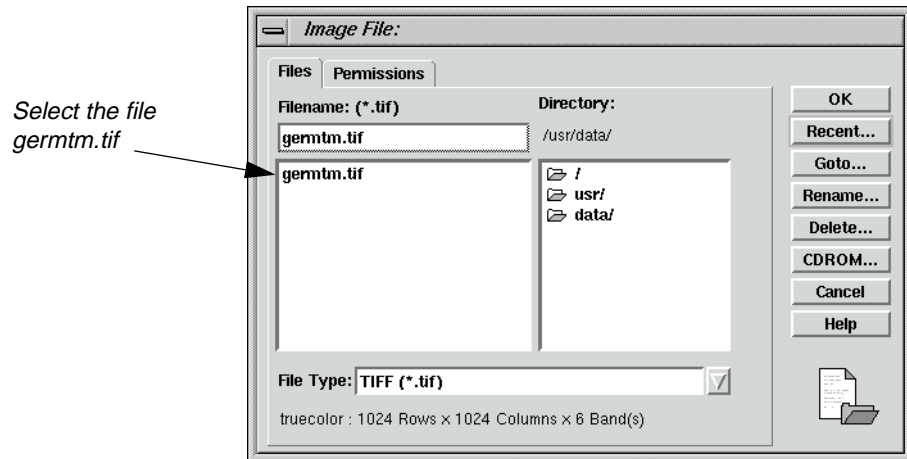

- Navigate to the directory in which you saved the file, and select the file **germtm.tif**.
- Click **OK** in the Image File dialog to transfer the information to the Image Commands dialog.

The Image Commands dialog updates accordingly, and the **Map Model to World** option is activated.

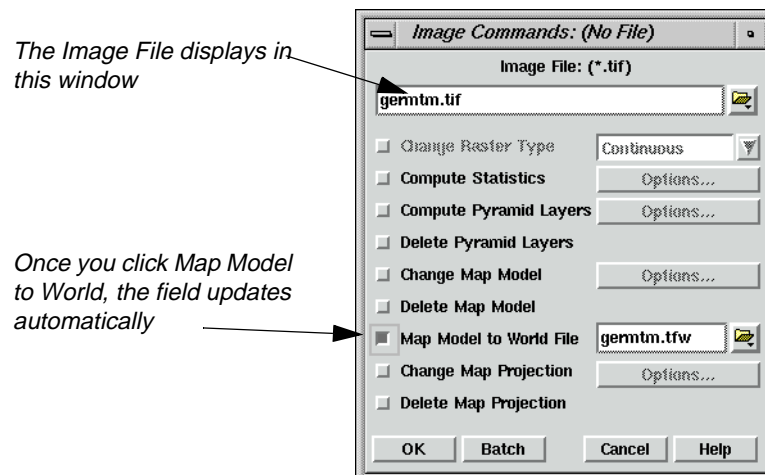

- Click the checkbox next to **Map Model to World**.



## Image Commands

By default, the Image Commands tool assigns the same name to the output file, but with the .tfw extension. In this case, the file name is **germtm.tfw**. The world file is saved in the same directory as the image you create it from.

6. If you wish, click the Open icon, and navigate to a different directory in which you want to save the world file. If not, proceed to step 9.



The File Selector dialog opens.

7. Type the name **germtm.tfw** in the **Filename** window, then press Return on your keyboard.
8. Click **OK** in the File Selector dialog.
9. Click **OK** in the Image Commands dialog to start the process.

A Job Status dialog opens, which tracks the progress of the function.

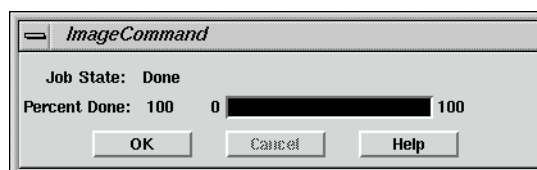

10. When the job is complete, click **OK** in the Job Status dialog.



---

*You can set a preference in the **User Interface & Session Category** of the Preference Editor, **Keep Job Status Box**, which allows the Job Status box to close automatically upon completion of a job.*

### Check for .tfw file

1. Using a UNIX shell or the Microsoft Explorer, navigate to the directory in which you created **germtm.tif**, and generated **germtm.tfw**.
2. Note the presence of the file in that directory.

```
winterm
[47]:/home/kswanson> pwd
/usr/data
[48]:/home/kswanson> ls
8bit_res_merge.eml      New_Model.gmd      sharp_dmtm.img
8bit_res_merge.mdl     germtm.aux         sharp_dmtm.rrd
8bit_res_merge.mdl.ed  germtm.rrd        sharpen.mdl
8bit_res_merge_TG.eml  germtm.tif         stretched.img
8bit_res_merge_TG.img  germtm.tif         stretched.rrd
8bit_res_merge_TG.rrd  mismatch.gmd      template1.aoi
AirMosaic.img          output.img
AirMosaic.rrd         output.rrd
[49]:/home/kswanson>
```

*The .tfw file resides in the same directory as the .tif file it was generated from*

Now, you can use the .tfw file to supply georeferencing information to other software packages, such as ArcView. Georeferencing information includes coordinate information.



## Image Commands





# CHAPTER 8

## Import/Export

---

### Introduction

The ERDAS IMAGINE Import function allows you to import a wide variety of data types for use in ERDAS IMAGINE. The Export function lets you convert image (ERDAS IMAGINE .img file format) files into one of several data formats.

In this tour guide, you can learn how to:

- import **SPOT** data from CD
- import **ERDAS 7.x GIS** and **Generic Binary Data** files
- export an image file in the **ERDAS 7.x LAN** format
- create a TIFF file
- view raw data values using the **Data View** option
- view image data information using the **ImageInfo** utility



---

*Approximate completion time for this tour guide varies depending upon the data you are importing or exporting.*

---

### Import a SPOT Scene

#### Prepare

Before you can import data from a peripheral device, such as a tape drive or a CD-ROM drive, you must configure the device in ERDAS IMAGINE.



---

*Refer to the current ERDAS IMAGINE Installation Guide for configuration instructions.*



---

*This section takes you through the steps to import SPOT data. Since each individual has different types of SPOT data, these steps are only an example.*

1. If your Session Log is not already open, select **Session | Session Log** from the ERDAS IMAGINE menu bar.

The Session Log displays real-time messages about what is happening throughout the import process. Following these messages closely helps you understand what is happening.

2. Click on the Import icon on the ERDAS IMAGINE icon panel.



The Import/Export dialog opens:



# Import/Export

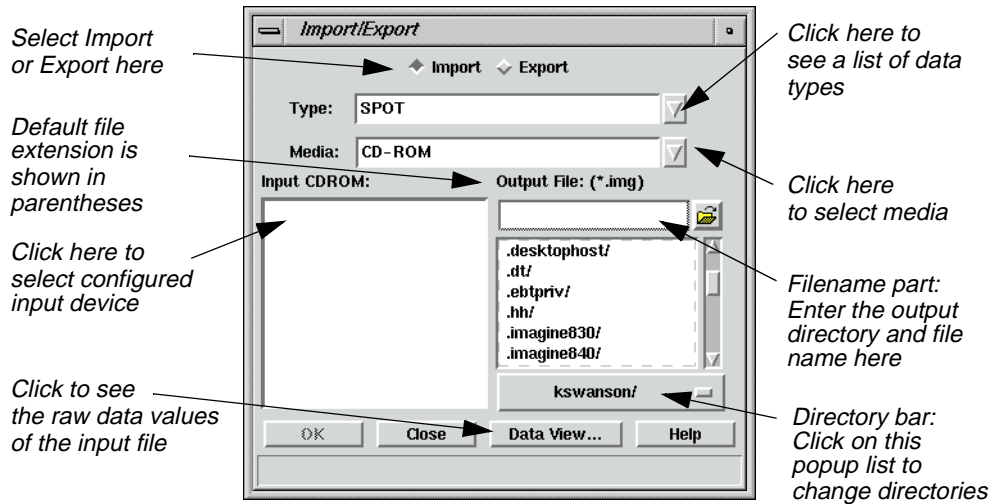

The **Import** button is enabled when the dialog first opens, so that all of the prompts that display in the dialog are for importing data. When you click on the **Export** button, the prompts change to options for exporting data.

3. Click on the **Type** popup list to select **SPOT** from the list of available importers.
4. Confirm that the **Media** defaults to **CD ROM**.

Displayed under **Input CDROM** is a list of configured CD-ROM drives.

5. Click to select the device from which you want to import data.



*If it is necessary to configure a new device, see the current ERDAS IMAGINE Installation Guide.*

6. Under **Output File**, enter a name for the output file in the directory of your choice. You can click on the directory bar popup list or enter the directory name in the filename part to select a different directory.
7. Click **OK** in the Import/Export dialog.
8. Watch the Session Log to see a report of the activities of the import process.

The Import SPOT dialog opens:

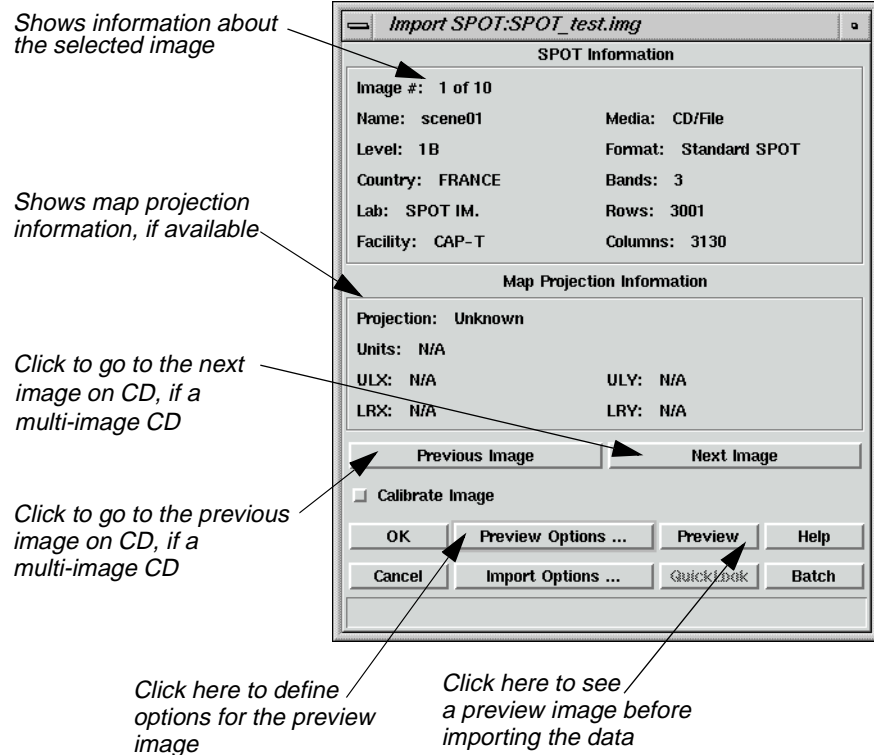

## Check Preview Options

1. Click on **Preview Options** and the following dialog opens:

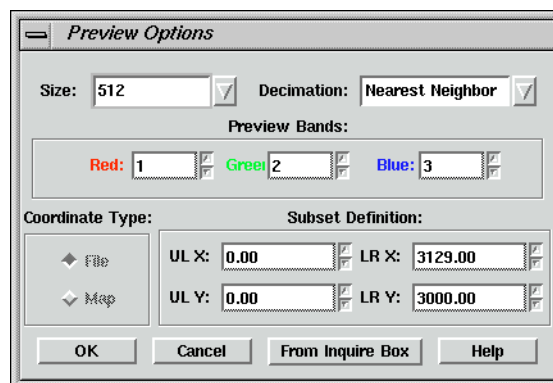

## Preview Options Dialog

The Preview Options allow you to import a decimated (i.e., reduced) version of the image file. You can view the image before importing to be sure that this is the image you want, or to define a subset area of the image to import.

The Preview Options dialog is the same for all importers. For example, if you were importing a Landsat TM scene and you wanted to preview the image, the Preview Options dialog would be identical to the one on page 163.

In the Preview Options dialog, you can set:

- **Size** of the displayed image—up to  $512 \times 512$  or  $1024 \times 1024$ .
- **Decimation—Nearest Neighbor** (provides a faster preview image, although it may appear blocky) or **Average Pixel** (averages groups of pixels, which provides a smooth image but may take longer, especially with large images).
- **Preview Bands**—the bands that are assigned the red, green, and blue colors in the previewed image (this option may not be applicable to some data).
- **Coordinate Type**—the type of coordinates used to define the subset. If there is no map information in the source image, only **File** coordinates are available.
- **Subset Definition**—define a subset area for previewing or importing.

2. Click **OK** in the Preview Options dialog.
3. Click **Preview** in the Import SPOT dialog.

A Job Status dialog displays, indicating the progress of the function.

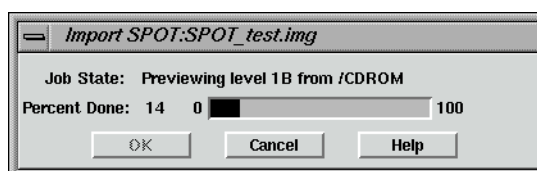

When the Job Status bar shows 100 (indicating that the job is 100% done), the dialog automatically closes. A Viewer window similar to the following opens and displays the preview image:

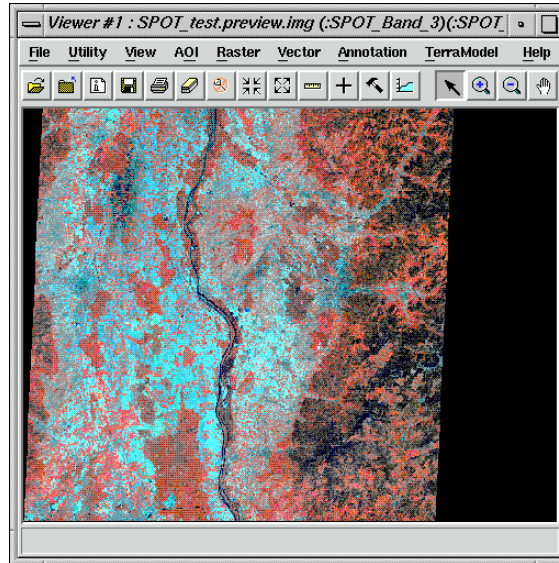

Preview images have a **.preview.img** file extension. Because the preview image is decimated, it is not suitable for image processing.

## Check Import Options

1. In the Import SPOT dialog, click on **Import Options**.

The Import Options dialog opens. This dialog is similar to the Preview Options dialog.

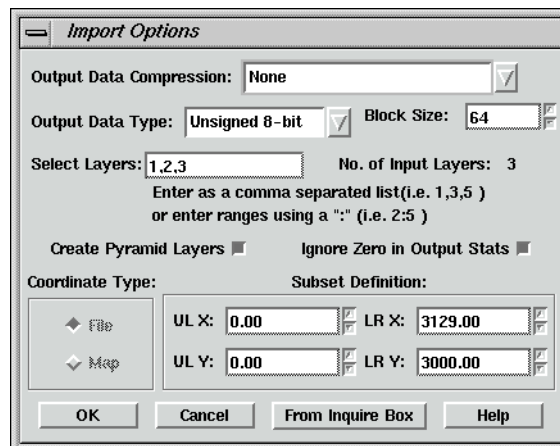

*NOTE: Like the Preview Options dialog, the Import Options dialog is the same for every type of importer.*

2. Select **Utility | Inquire Box** from the **SPOT\_test.preview.img** Viewer menu bar.



The Inquire Box Coordinates dialog opens and a rectangular box (the Inquire Box) is displayed in the center of the Viewer.

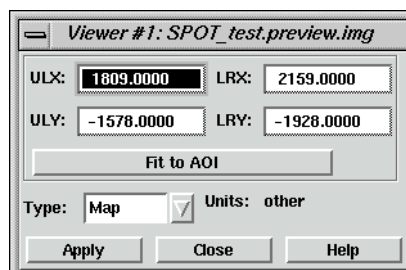

### Subset an Area

You can select a subset area to be imported by moving and resizing the Inquire Box in the Viewer:

- to resize the Inquire Box, hold and drag on the sides or corners of the box
- to move the Inquire Box, hold and drag in the center of the box

The coordinates update in the Inquire Box dialog as you move and/or resize the Inquire Box.

3. When you have selected the subset area to import, click on **From Inquire Box** in the Import Options dialog.

The coordinates for the subset area display in the Import Options dialog.



*Sometimes, when map coordinate information is not available in the source image, there are apparent differences between the Inquire Box coordinates and those transferred to the Import Options dialog. However, the imported image subset matches the area bounded by the inquire box.*

4. Click **OK** in the Import Options dialog.
5. Click **OK** in the Import SPOT dialog.

A Job Status dialog displays, indicating the progress of the import process:

Depending on your eml **Preferences**, when the Job Status bar shows 100 (indicating that the job is 100% done), you must either click **OK** to close the dialog or the dialog closes automatically.

6. Open a Viewer window and display the output file.

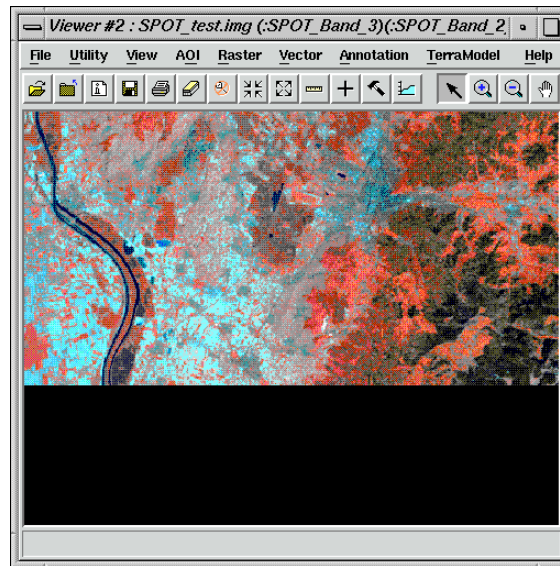

See "CHAPTER 4: Raster and Vector Data Sources" of the *ERDAS Field Guide* for more information on importing data.

## Export LAN Data

In this section, you export one of the image example files to an ERDAS Version 7.x LAN file.

### Prepare

ERDAS IMAGINE should be running and the Import/Export dialog should be open.

### Choose Export Options

1. In the Import/Export dialog, click on **Export**.
2. Click on the **Type** popup list to see a list of available exporters
3. Click to select **LAN (Erdas 7.x)** from the **Type** popup list.
4. Confirm that the **Media** lists **File**.
5. Enter **lanier.img** under **Input File**.
6. In the Import/Export dialog, ERDAS IMAGINE automatically enters **lanier.lan** as the output file. You may change this name if you want.



## Import/Export

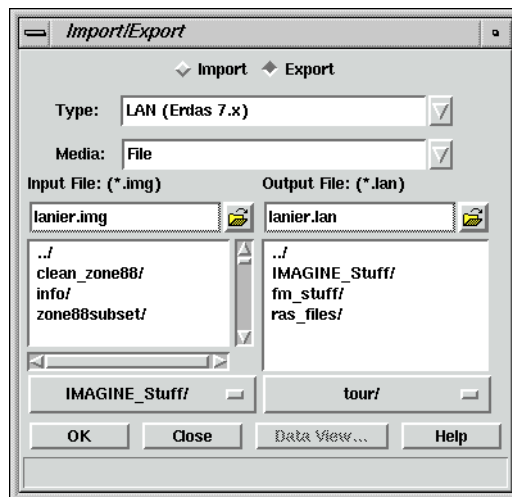

7. Click **OK** in the Import/Export dialog.

The Export ERDAS 7.5 LAN Data dialog opens:

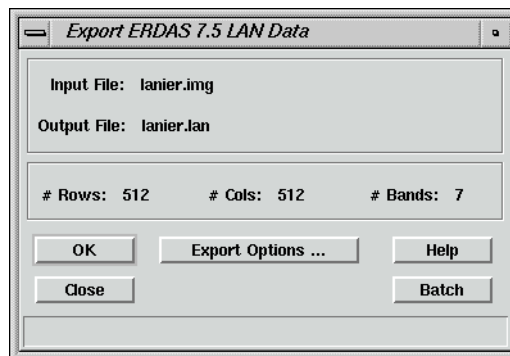

8. Click **OK** in the Export ERDAS 7.5 LAN Data dialog.

A Job Status dialog displays.

The file **lanier.lan** now resides in the selected directory.



### Creating LAN Data

ERDAS IMAGINE also creates two other files when it exports the LAN data:

- **lanier.pro**—contains map projection information
- **lanier.sta**—contains file statistics

These file formats are used in ERDAS 7.5 software. In ERDAS IMAGINE, map projection and file statistics are included in the image file format. You may delete the files **lanier.pro** and **lanier.sta** if desired, since they are not used in this exercise.

## Create .tif Files

In this section, run an ERDAS IMAGINE process, producing a .tif file instead of an image file.

*NOTE: Since the input image is georeferenced, the output TIFF image has geotiff tags. If you wish to produce a TIFF World file, select the Write option in the TIFF image file category of the Preference Editor.*

1. Click on the Classifier icon from the ERDAS IMAGINE icon panel.



The **Classification** menu opens.

*Click here to start the Unsupervised Classification*

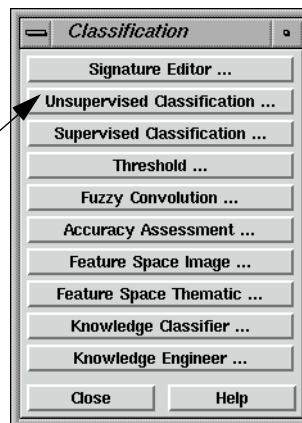

2. Click on **Unsupervised Classification** from the **Classification** menu.

The Unsupervised Classification (Isodata) dialog appears.



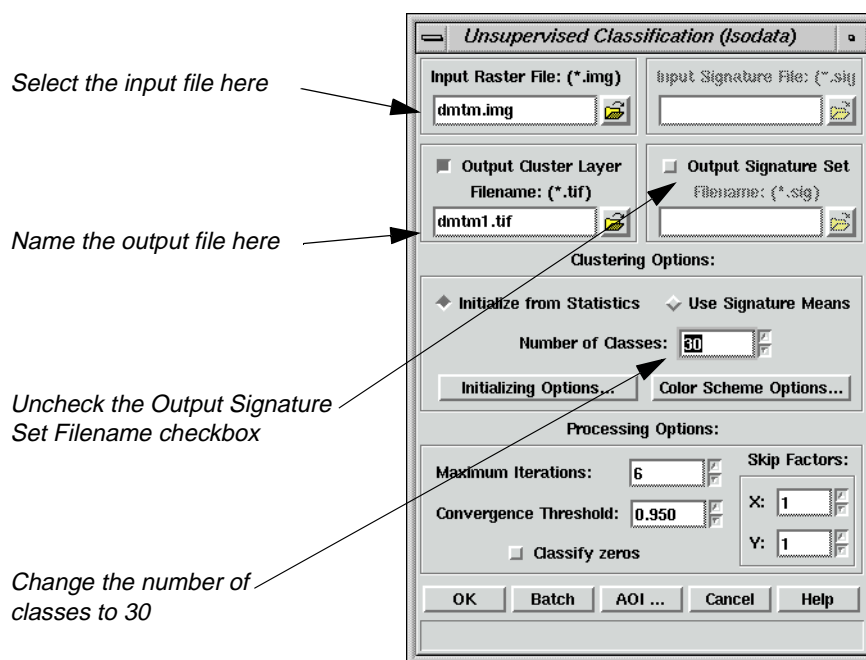

3. Click the Open icon by **Input Raster File**.



The Input Raster File dialog opens.

4. In the Input Raster File dialog, click **dmtm.img**, then click **OK**.



*The raster file, **dmtm.img**, is located in the <IMAGINE\_HOME>/examples directory.*

5. Click the Open icon next to **Output Cluster Layer Filename**.

The Filename dialog opens.

6. Navigate to a directory where you have write permission.
7. Click the **File Type** dropdown list, and select **TIFF (\*.tif)**.
8. Type in **dmtm1.tif** in the **Filename** field, and then click **OK**.
9. Change the **Number of Classes** to **30**. This tells the classifier how many classes to create.
10. Deselect the **Output Signature Set Filename** checkbox.
11. Click **OK** at the bottom of the Unsupervised Classification dialog.

The **Isodata to dmtm1.tif** dialog appears to perform classification of the file.

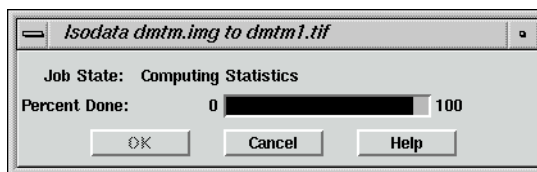

The resulting classification is created in the .tif format.

### Check the Classification

1. Click the Viewer icon to open a Viewer.



2. From the Viewer tool bar, click the Open icon.



3. In the Select Layer To Add dialog, click the **Recent** button.
4. Select the file **dmtm1.tif** from the top of the list.

Select *dmtm1.tif* from the top of the Recent Files list

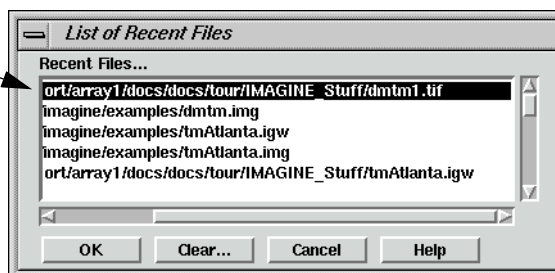

5. Click **OK** in the List of Recent Files dialog.
6. Click the **Raster Options** tab of the Select Layer to Add dialog.

## Import/Export

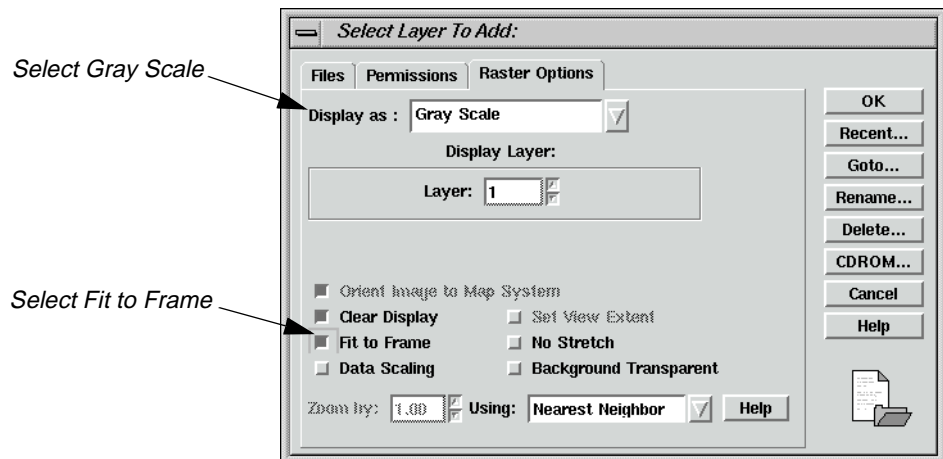

7. Click the **Display as** dropdown list and select **Gray Scale**.
8. Click the **Fit to Frame** checkbox.
9. Click **OK** in the Select Layer To Add dialog.

The file **dmtm1.tif** displays in the Viewer. The various shades of gray denote different classes of land cover.

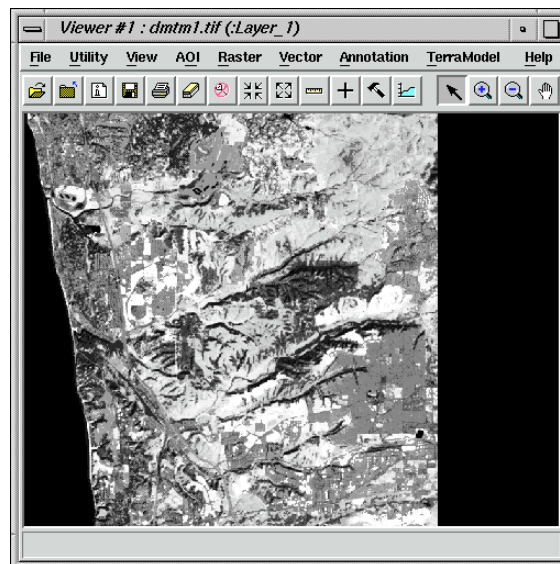

### Check Map Information

1. Click the ImageInfo Icon on the Viewer tool bar.

The ImageInfo dialog for **dmtm1.tif** opens.

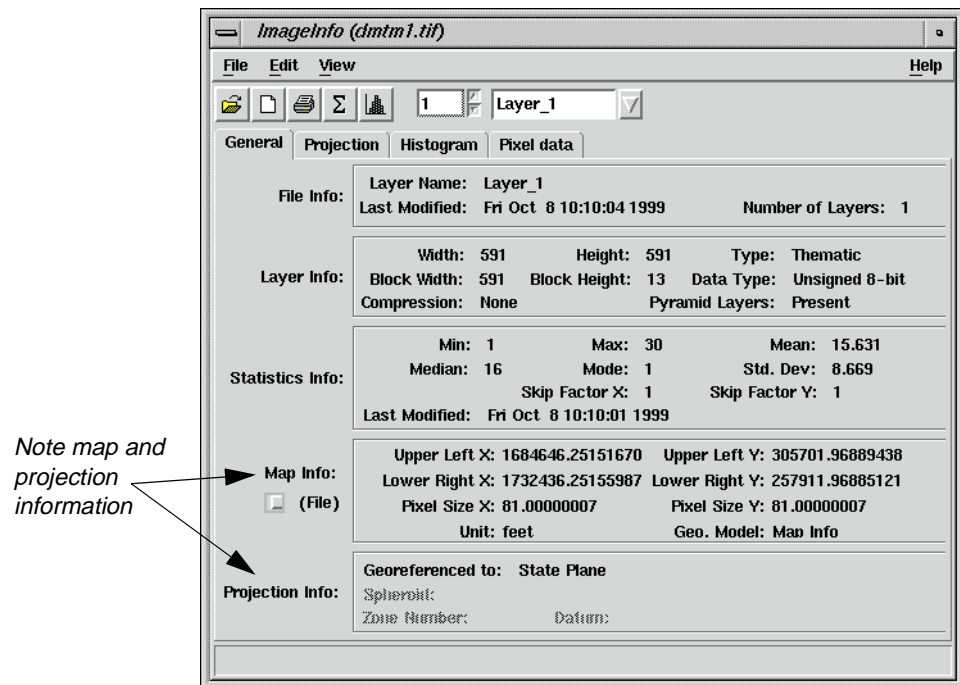

Note the information in the **Map Info** section and that the **Projection Info** section shows that the map is georeferenced to **State Plane**.

2. When you are finished, click **File | Close** in the ImageInfo dialog.
3. Click **File | Close** in the Viewer containing **dmtm1.tif**.

## Import Generic Binary Data

In this section, you import the **lanier.lan** file that you just exported. This file could be imported using the ERDAS 7.x LAN import function. However, you are using this file to learn how the Generic Binary Data dialog works.

This function is designed for importing data types for which there are currently no specific ERDAS IMAGINE importers.

1. In the Import/Export dialog, click on **Import**.
2. Click on the **Type** popup list and select **Generic Binary**.
3. Select **File** from the **Media** popup list.
4. Under **Input File**, select **lanier.lan**. Change directories if needed by clicking on the directory bar.



# Import/Export

ERDAS IMAGINE automatically enters this output file name with .img extension

Click here to select input file

Directory bar: Click this popup list to change directories

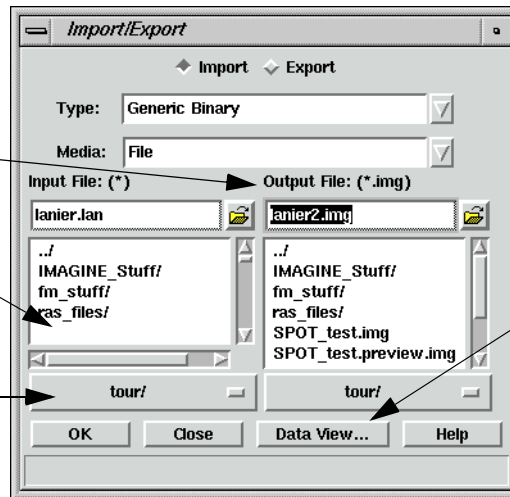

Click here to see raw data values and header information

5. Under **Output File**, ERDAS IMAGINE automatically enters **lanier.img** as the file name. If you try to save the file in the <IMAGINE\_HOME>/examples directory, an Attention message warns you that **lanier.img** already exists.
6. If the Attention dialog displays, click **No**.
7. In the Import/Export dialog, enter **lanier2.img** as the **Output File** in the directory of your choice.
8. In the Import/Export dialog, click **OK**.

The Import Generic Binary Data dialog opens.

This dialog requires you make many inputs that define the data structure for ERDAS IMAGINE. In some cases, you can get the information for these inputs from the header data of the file (using the **Data View** option from the Import/Export dialog), but you may have to rely on prior knowledge or assumption for the information.



*You must enter the correct inputs for the data you are importing. The defaults for this dialog are not acceptable for importing.*

## Data View

1. Click on the **Data View** button in the Import/Export dialog.

The DataView dialog opens. The data, as initially displayed, may not appear to be very useful. The following steps result in a display from which you can extract the information needed to complete the generic import.



*Data View is also available from the **Utility** menu on the ERDAS IMAGINE menu bar.*



## LAN File Format

The LAN format has the following characteristics:

- the first 128 bytes of the file are header data
- the number of bands is stored as a 16-bit integer in bytes 9 and 10
- the number of columns is stored as a 32-bit integer in bytes 17-20
- the number of rows is stored as a 32-bit integer in rows 21-24

With this knowledge, you can look at the data values in these bytes to obtain the information needed to import the file as generic binary data.

2. In the DataView dialog, click on **Data Type** and select **Unsigned 16 bit**.
3. In the DataView dialog, click on **Byte Order** and select **Intel**.
4. Set the **Offset** to **8** and check that the **Format** is **Decimal**.

The DataView dialog is updated to look like the following:

The screenshot shows the DataView dialog for the file `inet/morticia/export/array1/docs/docs/tour/lanier.lan`. The file size is 183520 bytes, last modified on Mon Sep 27 14:13:33 1999. The dialog shows the following settings:

- Record: 1
- Record Size: 256
- Offset: 8
- Data Type: Unsigned 16 bit
- Format: Decimal
- Byte Order: Intel

The data field displays the following values:

00000008:	0	0	0	512	0	
00000024:	0	0	0	0	0	
00000040:	0	0	0	0	0	
00000056:	0	0	0	0	0	
00000072:	0	0	0	0	0	
00000088:	1	0	0	0	0	
00000104:	0	0	0	40768	18531	
00000120:	0	16880	0	16880	17988	19786
00000136:	18765	17991	19529	17222	16704	16708
00000152:	17221	17216	16706	16452	16194	16963

Annotations in the image:

- "Unsigned 16 bit data selected because number of bands is two bytes" points to the Data Type dropdown.
- "Number of bands" points to the value '2' in the Record field.
- "Data field displays actual data values" points to the data table.
- "Offset equals 8 because number of bands begins in byte 9" points to the Offset field.
- A circled '7' in the first data row points to the first column of data.

5. In the DataView dialog, click on **Data Type** and select **Unsigned 32 bit**.
6. In the DataView dialog, click on **Byte Order** and select **Intel**.



## Import/Export

- Set the **Offset** to **16** and check that the **Format** is **Decimal**.

The DataView dialog is updated.

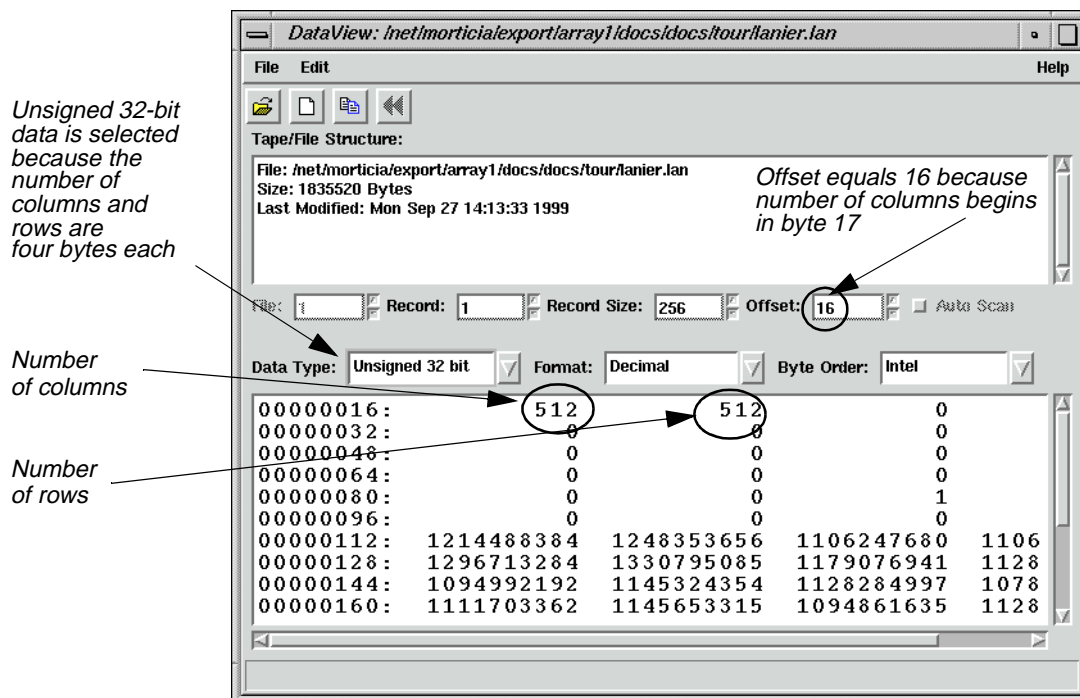

### Enter Image Dimensions

- In the Import Generic Binary Data dialog, next to **File Header Bytes**, enter **128**.

This is the number of bytes in the header, before the actual data values begin.

- Under **Image Dimensions**, for **# Rows**, enter **512**.
- Under **Image Dimensions**, for **# Cols**, enter **512**.
- Under **Image Dimensions**, for **# Bands**, enter **7**.

The Import Generic Binary Data dialog is updated.





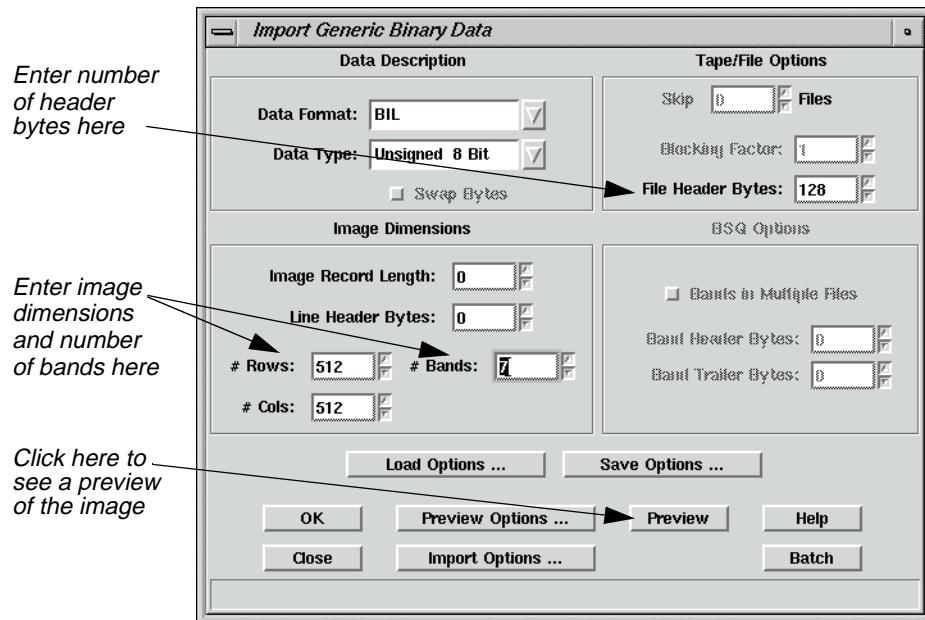

## Save Options

1. Click on **Save Options**.

The Save Options File dialog opens.

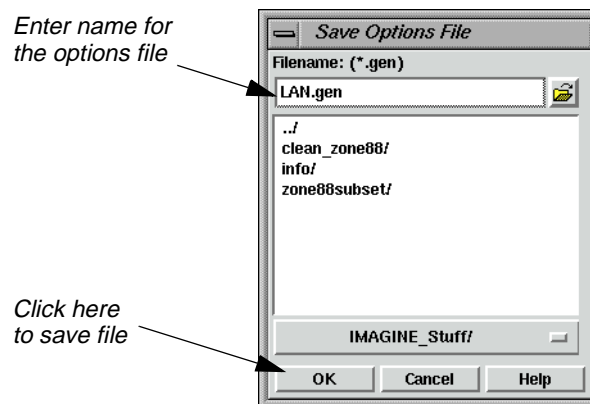

This dialog allows you to save the inputs you have entered to a .gen file. It can be recalled and loaded into the Import Generic Data dialog whenever you are importing data with this structure. This keeps you from having to find and enter the necessary inputs again.

2. Under **File name**, enter **LAN** and move the cursor out of the text field.

ERDAS IMAGINE automatically appends the default .gen file extension. Use a descriptive name that helps you to recognize the type of inputs saved in the file.

3. Click **OK** in the Save Options File dialog.



## Import/Export

These inputs are now saved and can be used again, when appropriate.



---

To load the .gen file at a later time, click on the **Load Options** button in the *Import Generic Binary Data* dialog.

### Preview the Image

1. In the Import Generic Binary Data dialog, click on **Preview**.

A Job Status dialog displays. When the Job Status bar shows 100 (indicating that the job is 100% done), the dialog closes automatically.

A Viewer automatically opens and displays the file **lanier2.preview.img**. The .preview file extension is added to indicate that this is a decimated preview file (not suitable for processing).

2. Open another Viewer window and display the file **lanier.img**.

You see that the two files are similar in appearance. The difference in these files is that **lanier.img** has map projection information and **lanier2.preview.img** does not. This is because when **lanier.img** was exported to a .lan file, the map information was exported to **lanier.pro**, which is a format used in ERDAS 7.5. The map projection data in **lanier.pro** was not imported with the Generic Binary Data importer.

However, the imported image does contain statistics (similar to the statistics exported to **lanier.sta**), because statistics are recalculated after a raster file is imported.

3. In the ERDAS IMAGINE menu bar, select **Session | Close All Viewers**.

---

### Get Image Information

The ImageInfo utility is a function that gives you information about ERDAS IMAGINE image files. With this function you can access any image file and see the:

- date of last modification
- number of Layers
- layer information: Width, Height, Type, Block Width, Block Height, Data Type, Compression, and Pyramid Layer status for each layer in the file
- calculated statistics
- map coordinates, when available
- map projection information, when available

*NOTE: **ImageInfo** can only be used for image files. Use **Vector Info** for vector coverages.*

### Edit Image Information

In image files that have write permission, you can edit file information or perform the following operations using the ImageInfo dialog:

- change layer name
- compute statistics
- add, change, or delete map information



- add, change, or delete map projection
- delete calibration
- access the Raster Attribute Editor to change file attributes, such as color, histogram values, etc.

**View Image Information** In this section, you use the ImageInfo utility to learn more about the **lanier.img** file.

1. Select **Tools | Image Information** from the ERDAS IMAGINE menu bar.

The ImageInfo dialog opens.



*This option is also accessible from **Session | Tools | Image Information** on the ERDAS IMAGINE menu bar.*

2. Select **File | Open** from the ImageInfo menu bar, or click the Open icon on the tool bar.



The Image Files dialog opens. This dialog allows you to select a file for which information is displayed in the ImageInfo dialog.

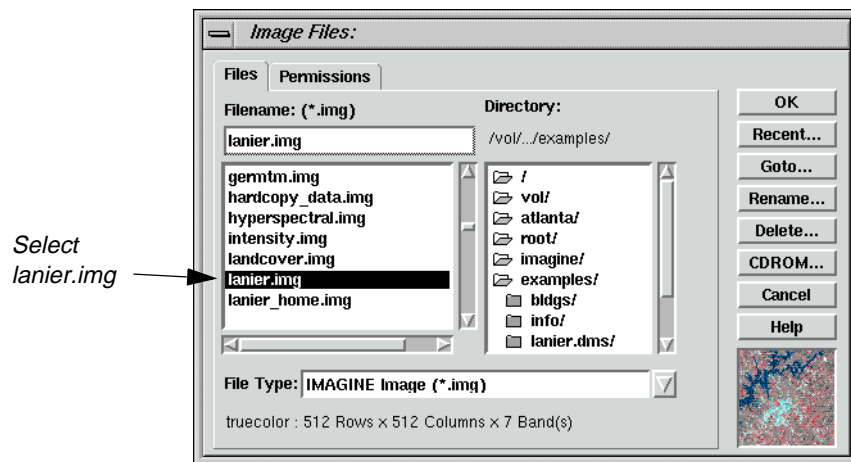

3. Under **Filename**, select **lanier.img**.
4. Click **OK** in the Image Files dialog.

The information for **lanier.img** displays in the ImageInfo dialog.



## Import/Export

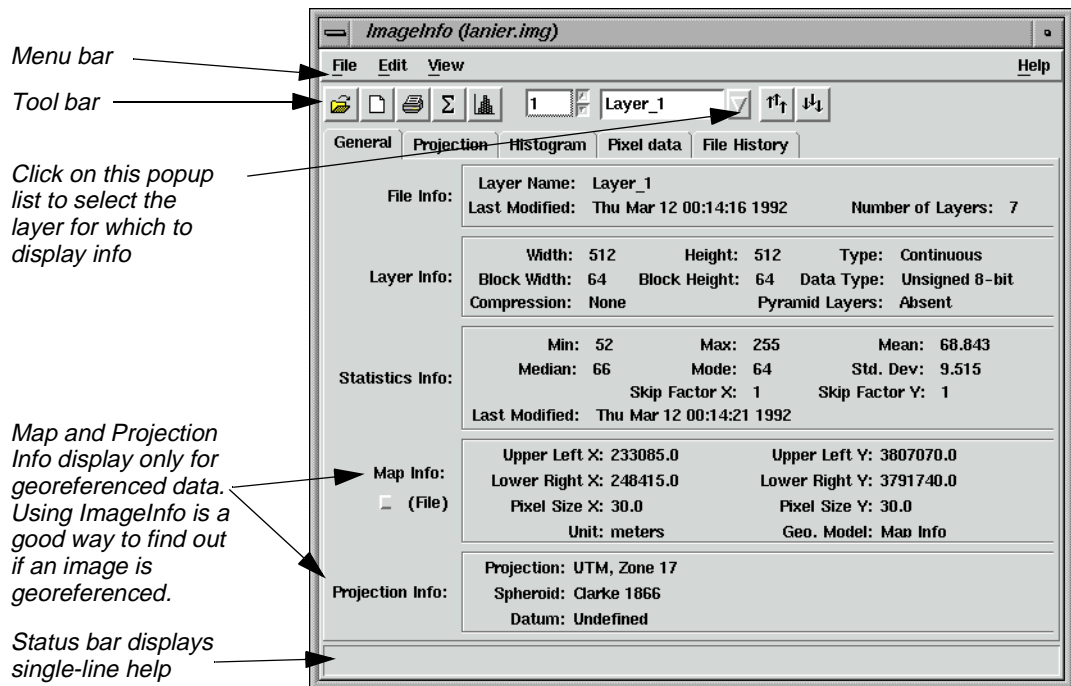

5. Look over the information listed in the dialog.



The functions in the *ImageInfo* menu bar are described in detail in "ImageInfo Menu Bar" on page 612 and the functions in the tool bar are described in "ImageInfo Tool Bar" on page 612.

Since this is a write-protected file, none of these values can be changed. If you want to practice editing image information with this dialog, you can copy **lanier.img** to the directory of your choice and change the write protections. Then open the writable file in the ImageInfo dialog and click on **Edit** to use the editing functions.

6. Select **File | Close** from the ImageInfo menu bar when you have read the information in the dialog.



For more information about *Import/Export*, see "APPENDIX A: Additional Information" on page 595.

# CHAPTER 9

## Batch Processing

---

### Introduction

The ERDAS IMAGINE Batch Wizard allows you to process one or more files with one or more commands at any time, from immediately to many years in the future.<sup>1</sup> This is useful if you have a process that requires a long time to run and you want to run it when your system is at minimum utilization (e.g., during the night). It is also useful if you wish to run a repetitive task many times, such as executing the reprojection command to reproject hundreds of images.

Some of the ERDAS IMAGINE functions that can be included in a Batch job are:

- classification
- rectification
- radar processing
- Image Interpreter
- import/export
- reproject

Most of the processing dialogs in ERDAS IMAGINE, such as Importers, Exporters, Image Interpreter functions, Data Preparation functions, and others have a **Batch** button. This button is used to place the command in the Batch queue instead of actually performing the operation. Off-line processing allows unattended operation, enabling you to log off if you wish.



*The Batch wizard is distributed as part of the IMAGINE Essentials module, but can be used with functions from other modules. Consequently, some portions of this chapter may not compute successfully unless you also have an IMAGINE Advantage license, because functions from that module are used in the examples.*



*On systems where off-line processing is not available, the options for processing at a later time are not available.*



*On Microsoft Windows NT, your account must have administrator privilege to schedule jobs at a later time.*



*Approximate completion time for this tour guide varies, depending upon the data you select for Batch processing.*

1. Under Windows NT, a job cannot be scheduled beyond the end of the current month.



# Batch Processing

## Set up/Start the Scheduler on NT and 2000

Before you can use the Batch Wizard to schedule jobs to run at a later time on Windows NT systems, you must set up and run the Scheduler. This requirement means that the account that starts Scheduler must remain logged-in for the scheduled job to run.

You must log in as an administrator or as a person with administrator privileges to set up and start the Scheduler. Once started, the Scheduler is available for use by any other person with administrative privileges.

1. From the **Start** menu, select **Settings | Control Panel**.



2. On the Control Panel, select the **Services** icon.

*Select Schedule from the Services dialog*

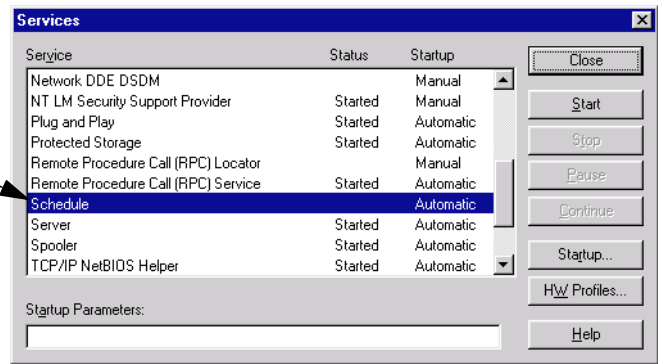

3. Scroll through the Services window and select **Schedule**, then click the **Startup** button.

*Select Automatic*

*Enter your account and password information here*

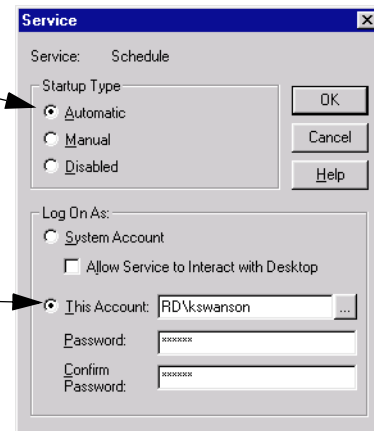

4. In the Service dialog, select **Automatic** as the **Startup Type**, then click the **This Account** checkbox. Enter your account name and password, confirm your password, and then click **OK**.

## Execute a Single File/Single Command

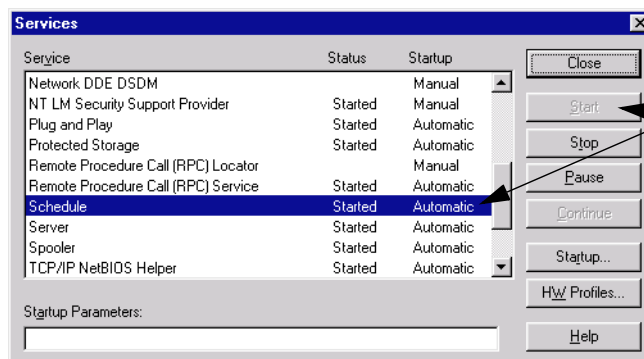

5. Click the **Start** button in the Services dialog.

*NOTE: The ability to run Batch at a later time is built using the Windows scheduler, which is part of the **at** command. Refer to the Windows help to learn more about the use of the **at** command.*

*NOTE: (Microsoft Windows NT) If you are submitting jobs for processing later and you are using mapped network drives, then you need to ensure that these maps are in place when the Batch job runs. Typically, a mapped drive is only available to the current user unless the **Reconnect at Logon** option was checked on the Map Network Drive dialog when the drive was mapped.*

*If this option is not checked, then when the Batch process is run by the Scheduler, it is not able to find the drive. This is one of the reasons to make sure that the Schedule service runs as your account name. This ensures that remembered network drive maps are reestablished when the Batch process runs.*

*NOTE: (Microsoft Windows 2000 and Microsoft Office 2000) If you are using Windows 2000 or have installed Office 2000 on Windows NT, the Scheduler service is replaced by a new service called the Microsoft Task Scheduler. In this environment, you no longer need to have administrator privileges to submit jobs; however, you do still need to have administrator privileges to start the Task Scheduler service.*

---

### Use Batch with a UNIX System

Unlike the Scheduler on NT, you do not have to be an administrator or a person with administrator privileges to set up Batch to run on a UNIX system.

On UNIX, the ability to run Batch at a later time is built using the UNIX **cron** system. See the man pages for more information about **cron** and the **at** command on UNIX.

---

### Execute a Single File/Single Command

This operation is very useful for performing lengthy processes on large files.

1. From the ERDAS IMAGINE icon bar, click the **Interpreter** icon and then select **GIS Analysis | Clump** to open the Clump dialog.



# Batch Processing

2. In the Clump dialog, select <IMAGE\_HOME>/examples/Insoils.img for the **Input File** name and <your\_workspace>/Insoils\_clump.img for the **Output File** name.

Where <your\_workspace> is the **Default Output Directory** specified in the **User Interface & Session** category in the Preference Editor, and <IMAGE\_HOME> is the directory where ERDAS IMAGINE is installed.

3. In the Clump dialog, click the **Batch** button. The Batch Wizard opens with the **Select Type of Command Processing** panel displayed. The **Use commands as they are** button is already selected.

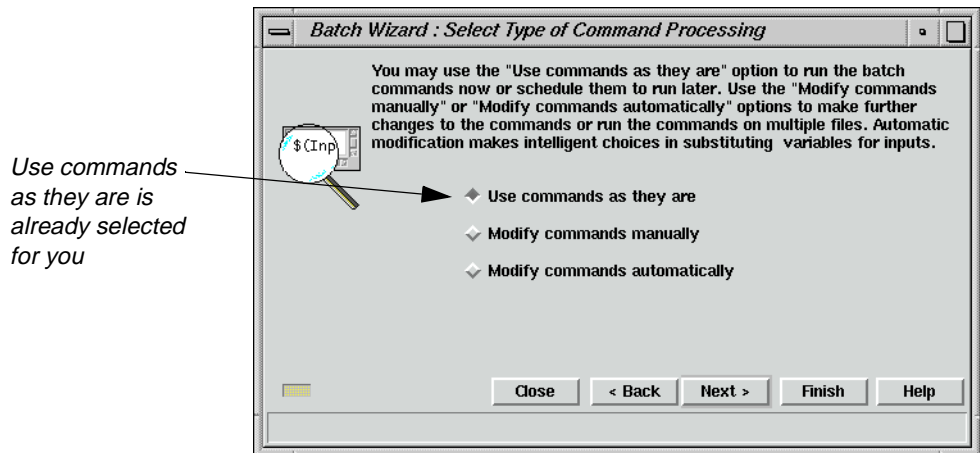

4. Click the **Next >** button. The **Select When to Process Commands** panel displays. The **Start Processing Now** button is already selected. If you wish to process the file immediately, go to step 6.

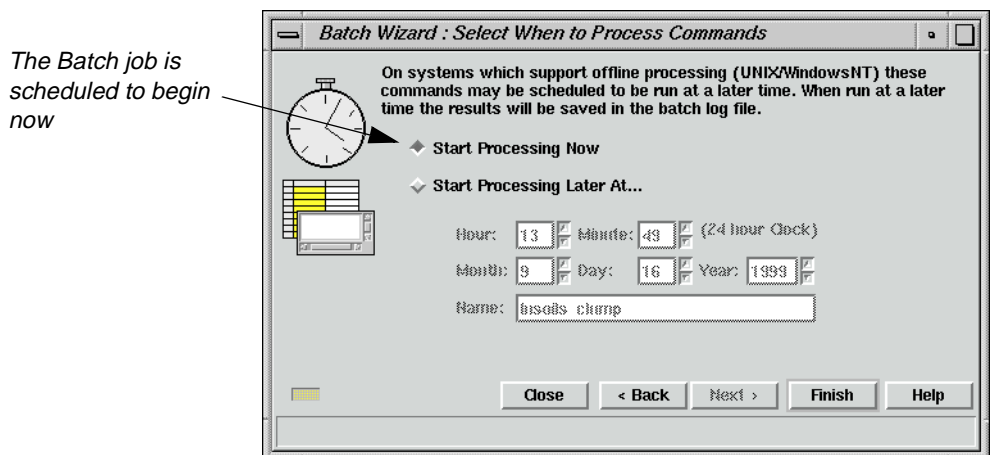

5. If you wish to process the file at a later time, click the **Start Processing Later At...** option, and set the time you wish it to begin processing.



## Execute Multiple Files/Single Command—Run Now

- Click the **Finish** button in the **Select When to Process Commands** panel to begin processing. A double Job Status dialog opens showing the progress of each individual file along with progress of the overall job. When the job is complete, the **OK** button is enabled.

This meter tracks the progress of an individual file

This meter tracks the progress of all the files in the Batch job

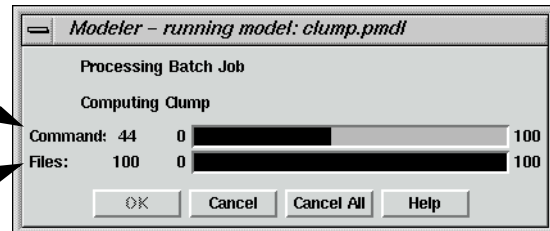

- Click **OK** to close the status meter.

The clump operation is complete. If you wish, you can open a Viewer and check the file.

---

## Execute Multiple Files/Single Command—Run Now

The ability to execute a command on multiple files is very useful. In the following example, the Batch Wizard is used to compute statistics for several TIFF images.

*NOTE: You must provide your own TIFF files for this exercise.*



See "CHAPTER 7: Image Commands" on page 153 for instructions on how to use Image Interpreter utilities to create TIFF images from image files.



*It is important to note that some processes depend upon the physical extents of the imagery, or the number of bands, or data types, or the projection parameters, etc. You must be aware of both the requirements of the processes (commands) as well as the differences between the file types to be processed. In many cases, the data sets provided to multiframe processing jobs must share common physical and ephemeral aspects.*

## Set TIFF Image File Preferences

- Select **Session | Preferences** from the ERDAS IMAGINE menu bar to open the Preference Editor dialog, and select the **TIFF Image Files** category.



## Batch Processing

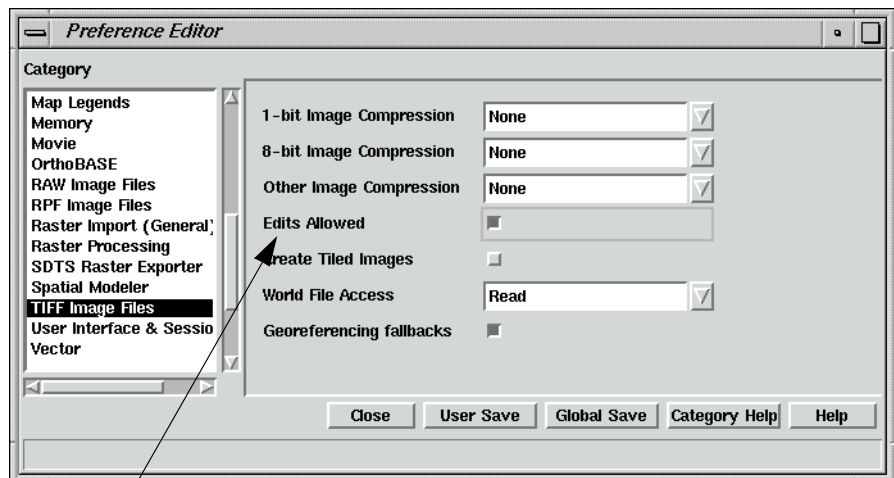

*Make sure that edits are allowed*

2. Ensure that the **Edits Allowed** option is enabled (checkbox checked). If you want this to be the default, click **User Save**. Click **Close**.

Now you are ready to start the Image Command Tool, which provides Batch access to many of the functions that the Image Information tool provides interactively.

### Start the Image Command Tool

1. Select **Tools | Image Command Tool** from the ERDAS IMAGINE menu bar to open the Image Commands dialog.
2. Click the File Open icon on the Image Commands dialog. In the File Selector dialog, click the **Files of Type** popup list and select **TIFF**. Select a TIFF file and click **OK**. The options on the Image Commands dialog are now enabled.

*NOTE: If you do not have a TIFF file, one is created in the exercises of "CHAPTER 7: Image Commands" on page 153.*

## Execute Multiple Files/Single Command—Run Now

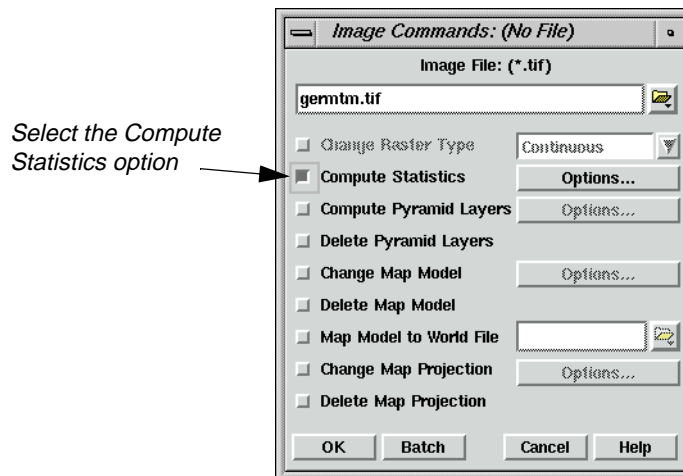

3. Check the **Compute Statistics** checkbox on the Image Commands dialog.

### Start the Batch Wizard

1. Click the **Batch** button in the Image Commands dialog.

The Batch Wizard starts, and the **Select Type of Command Processing** panel displays. If you click the **Finish** button now, the job runs on the selected file. However, it is more useful to automate the process to run on several files.

2. Select the **Modify commands manually** option in the **Select Type of Command Processing** panel.
3. Click the **Next >** button to display the **Edit Commands/Create Variables** panel.

Notice that the command, visible in the window, contains the full path of the selected file. In order for the software to be able to make file name substitutions from a list, there must be a variable into which the substitution is made. This is done in the following step.



# Batch Processing

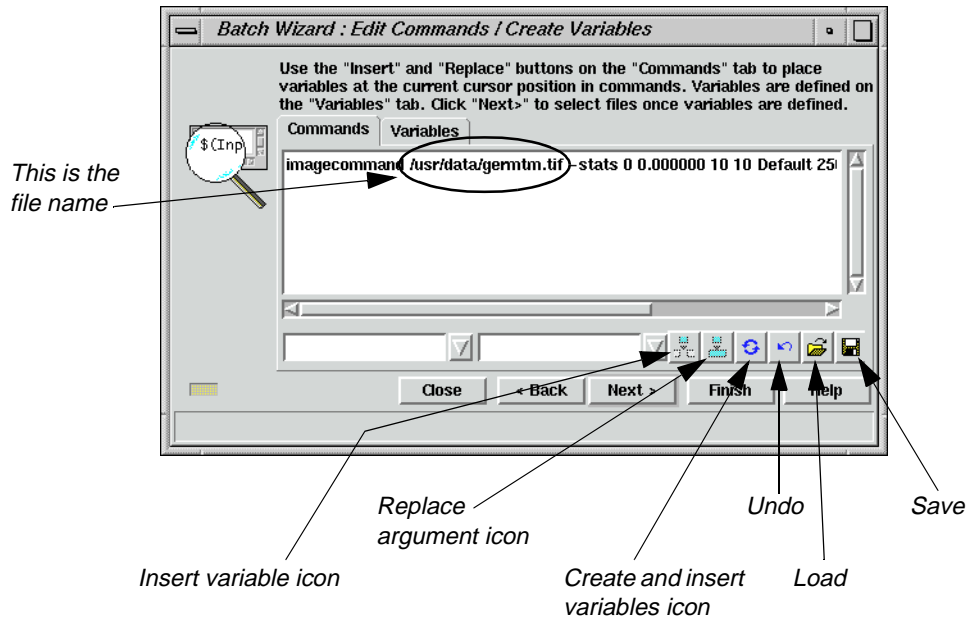

4. Click the Create and Insert Variables button to create variables.



This tool examines the command for file names and replaces them with variables. In this case, one variable called **Input** is created and replaces a specific file and path.



For more information about variables, see "Work with Variables" on page 204.



The Batch commands can be saved for future use. See "Save/Load Options" on page 209.

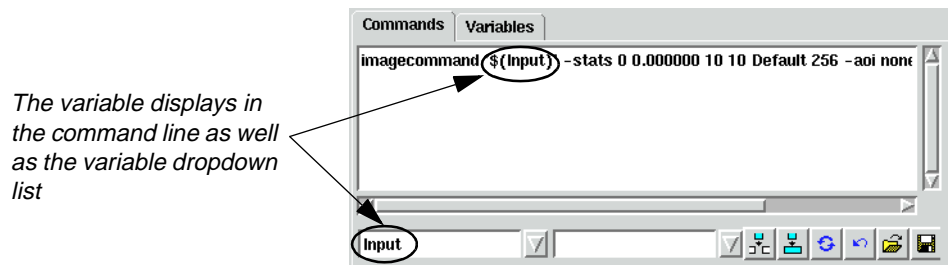

5. Click the **Next >** button to display the **Select Files to Process** panel.

## Execute Multiple Files/Single Command—Run Now

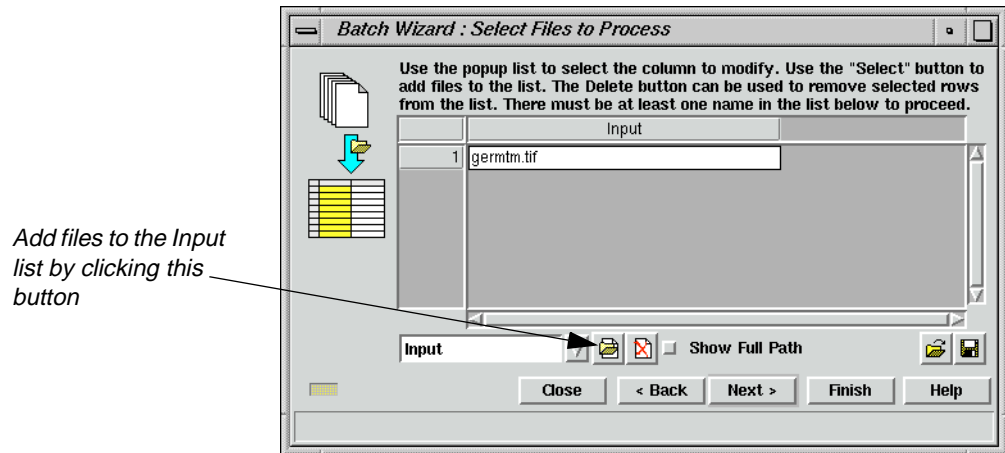

6. Select the Add Files button. This opens the File Selector dialog. Click the **File Type** popup list and select **TIFF**.



*NOTE: If you are working on the Windows platform, files can be added to the **Input** list by dragging and dropping from Explorer.*

7. Select another TIFF file, and then click the **Multiple Files Selection** tab.
8. Click the **Use the following Selection Pattern** checkbox. The default wild card displayed in the **Selection Pattern** field selects all TIFF files in the specified directory. You may modify the wild card as needed.

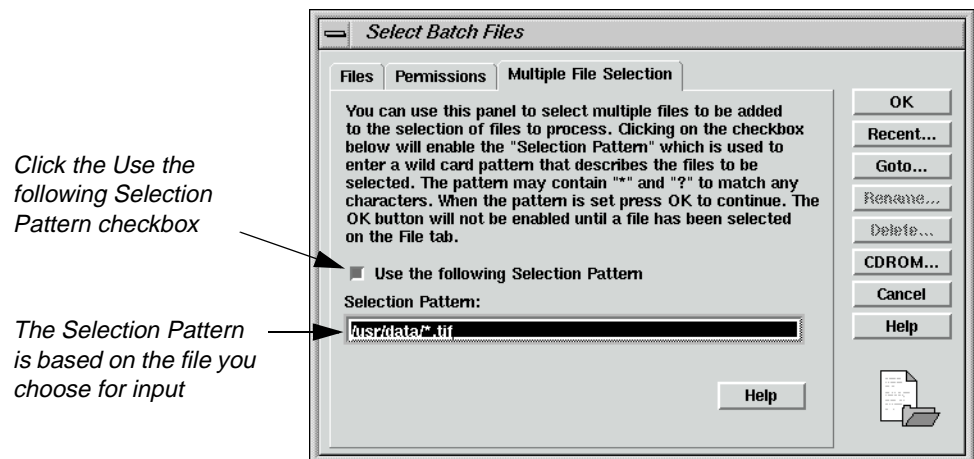

## Batch Processing

- Click the **OK** button on in the **Multiple File Selection** tab. The specified TIFF files are added to the list in the **Select Files to Process** panel in the **Input** column.

*NOTE: You can repeat step 6. through step 8. to choose TIFF files from other directories.*

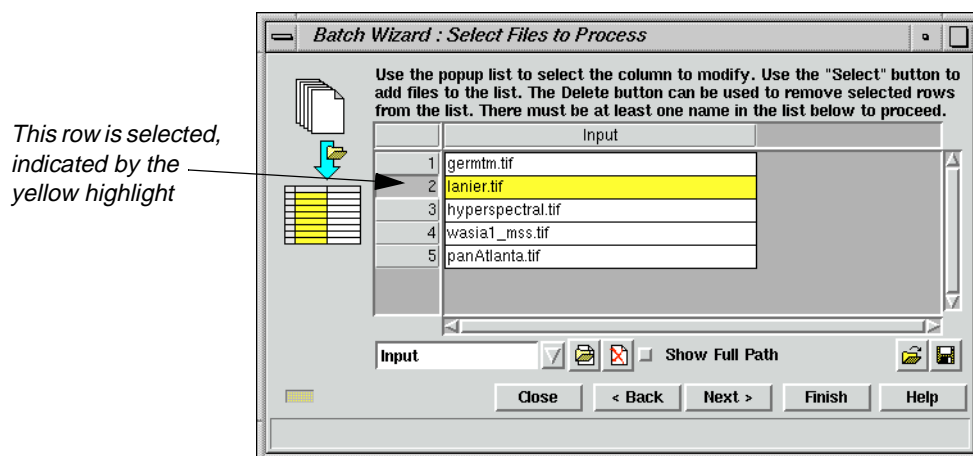

*NOTE: Entries in the list may be selected by clicking in the number column as shown above, and then removed from the list with the Delete icon.*



- Click **Finish** to start computing statistics on the listed images now. A double Job Status dialog displays showing the progress of each individual file along with progress of the total job. When the job is complete, the **OK** button is enabled. Click **OK** to close the Job Status dialog.

### Execute Multiple Files/Single Command—Run Later

In the following example, you are going to perform reprojection on all of the Lake Lanier related files in the ERDAS IMAGINE examples directory.

*NOTE: For Windows NT users, you must be an administrator or a person with administrator privileges to run a Batch process at a later time.*

- From the ERDAS IMAGINE icon bar, click the **DataPrep** icon and then select **Reproject Images** to open the Reproject Images dialog. Select **lanier.img** as the **Input File** and **lanier\_reproj.img** as the **Output File**. Select **UTM WGS 84 South** from the **Categories** popup list. Select **UTM Zone 25** from the **Projection** popup list.

*NOTE: If you are creating projections of your own, do not include a slash (/ or \) in the name. The Batch processor uses the presence of a slash in a name to decide if it is an argument to be converted to a variable.*

## Execute Multiple Files/Single Command—Run Later

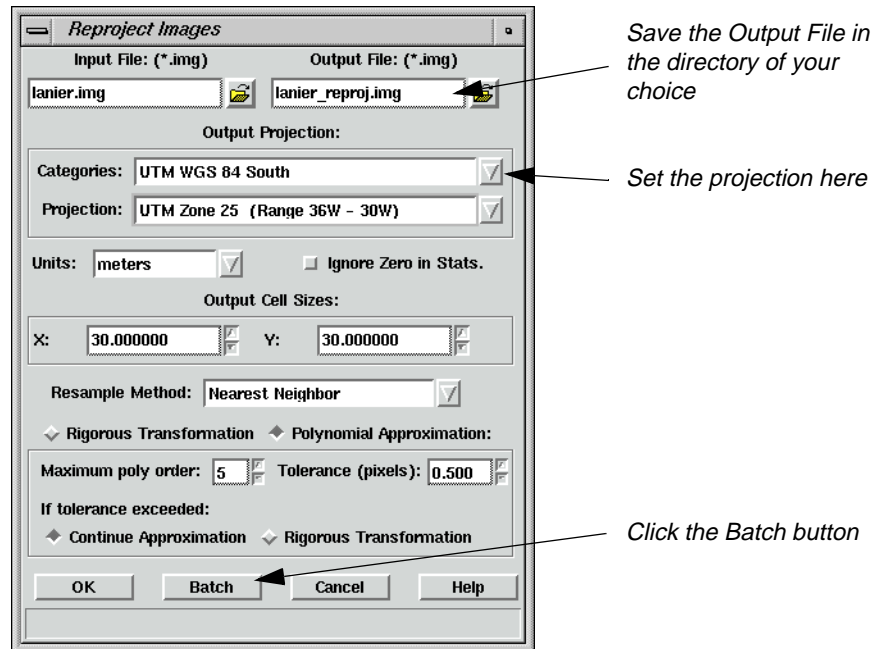

2. Click the **Batch** button. The Batch Wizard starts with the **Select Type of Command Processing** panel. Select the **Modify commands automatically** option.
3. In the Batch Wizard, click the **Next >** button to open the **Edit Commands/Create Variables** panel. Ensure the **Commands** tab is selected. Using the horizontal scroll button, scroll about 2/3 to the left and observe that **Input** and **Output** variables have already been created in the command line.

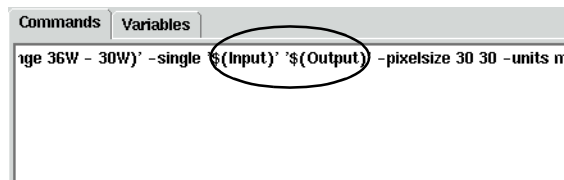

For more information about variables, see the “Work with Variables” section on page 204.

4. Click the **Next >** button. The **Select Files to Process** panel opens with the selected input file displayed.

The popup list in the **Select Files to Process** panel determines which variable is populated when the Add Files button is pressed. In this example, there is only an **Input** variable.



# Batch Processing

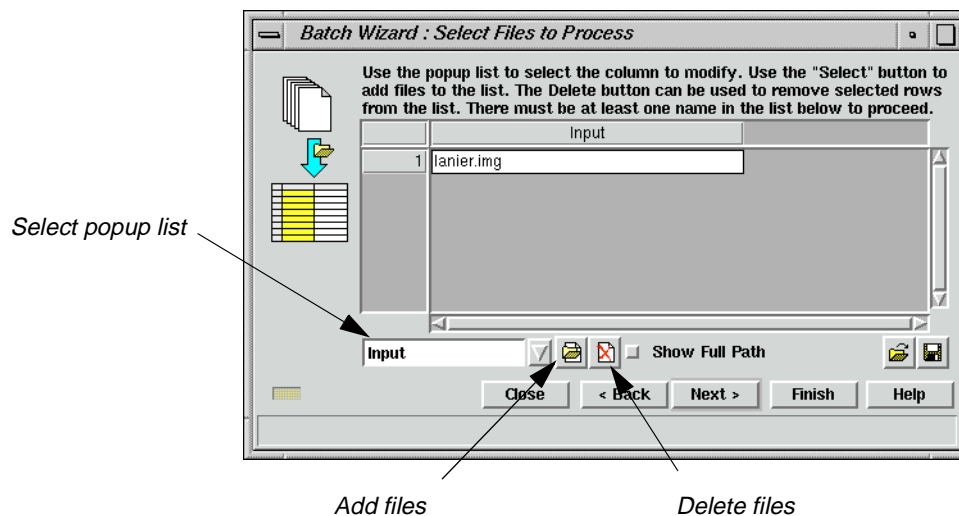

By default, there is always an **Input** column in the list, which corresponds to the default **Input** variable.

## Add Multiple Files

1. Click the Add Files button. The Select Batch Files dialog opens.



2. Select **Ininspect.img** from the Select Batch Files dialog. Click the **Multiple File Selection** tab and click the **Use the following Selection Pattern** checkbox. Edit the **Selection Pattern** field to insert **In** before the asterisk. It should look like this:

```
<IMAGINE_HOME>/examples/ln*.img
```

Where <IMAGINE\_HOME> represents the installation directory of ERDAS IMAGINE on your system.



## Execute Multiple Files/Single Command—Run Later

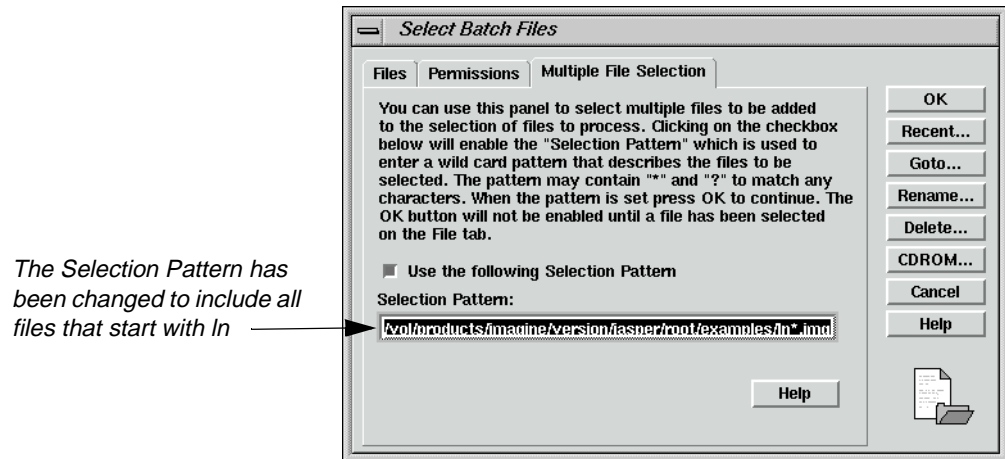

3. Click the **OK** button in the Select Batch Files dialog.

The input files are displayed under the **Input** column. Select and delete any duplicate or unwanted files by clicking in the numbered column next to the file name and then clicking the Delete Files icon. This list of input files may be saved for future use.



See “Additional Information” on page 209 for information about saving files.

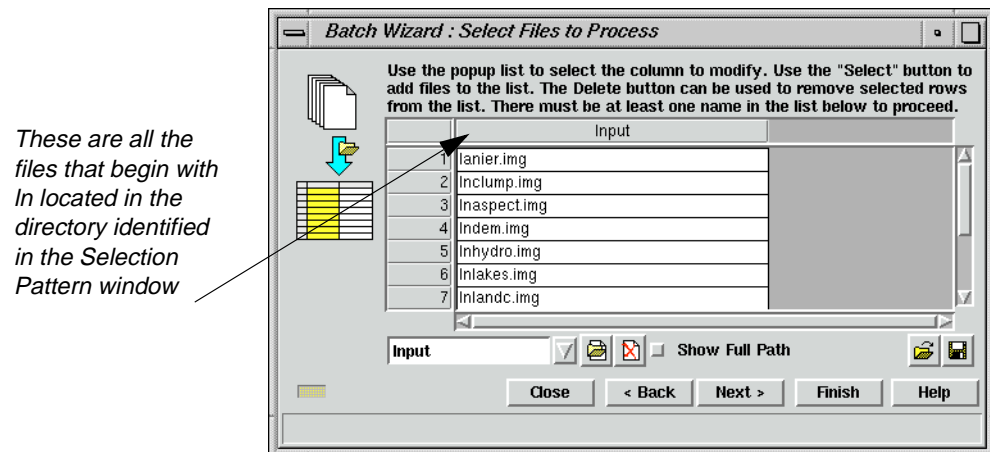

4. Click the **Next >** button to open the **Select When to Process Commands** panel. Click the **Start Processing Later At** checkbox. Use the default time of the next available minute.



# Batch Processing

This Batch file begins on 21 October 1999 at 3:09 p.m.

When you schedule Batch jobs later, a Name is assigned. Names cannot contain certain characters or spaces. Batch renames the job accordingly.

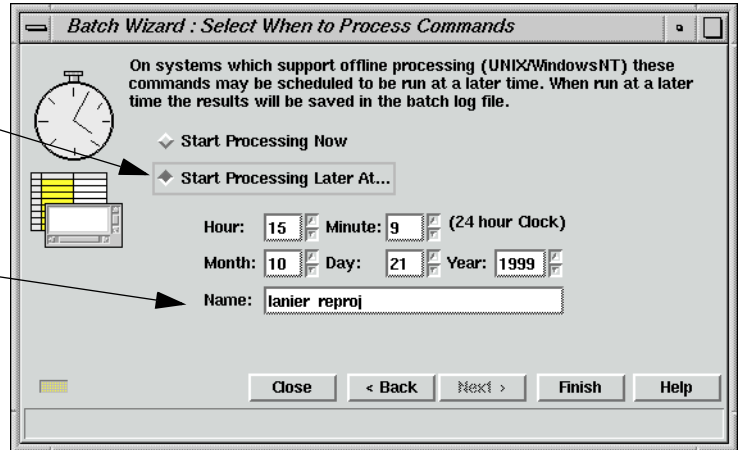

The following characters are converted to a - (dash) when present in the **Name** field of the **Select When to Process Commands** panel: \, /, \*, ?, |, <, and >. Spaces and tabs are converted to an \_ (underscore).

5. Click the **Finish** button to begin processing. The Scheduled Batch Job List dialog opens, displaying all current Batch jobs.

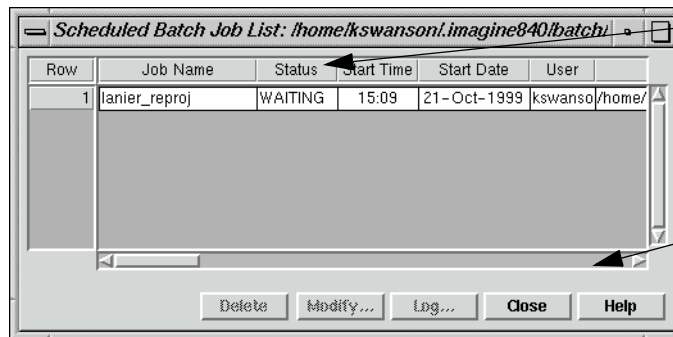

Status starts as **WAITING**

You can use the scroll bar to see the complete path of the Job File

The Scheduled Batch Job List dialog may be opened any time by selecting **Session | View Off-line Batch Queue** from the ERDAS IMAGINE menu bar.

When the job begins, the **Status** changes from **WAITING** to **ACTIVE**. When the job has finished, the **Status** changes from **ACTIVE** to **DONE**.

When the job is done, the log file can be viewed by first selecting the job in the Scheduled Batch Job list dialog, and then clicking the **Log** button. This is useful for checking to see if your Batch command ran successfully on all of the input files.

## Execute Multiple Files/Multiple Commands

The log displays in a text editor

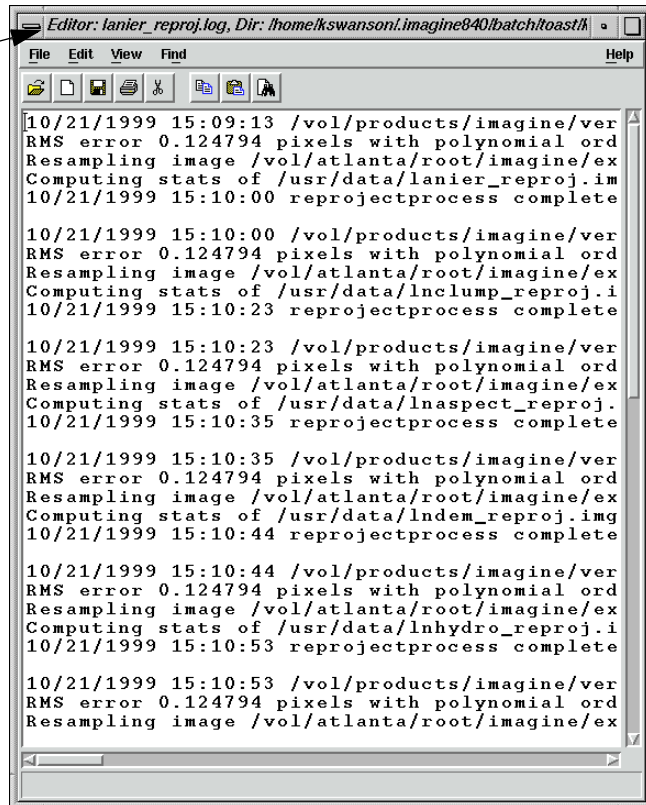

```
Editor: lanier_reproj.log, Dir: /home/kswanson/imagi840/batch/toast/k
File Edit View Find Help
[10/21/1999 15:09:13 /vol/products/imagi/ver
RMS error 0.124794 pixels with polynomial ord
Resampling image /vol/atlanta/root/imagi/ex
Computing stats of /usr/data/lanier_reproj.im
10/21/1999 15:10:00 reprojectprocess complete

10/21/1999 15:10:00 /vol/products/imagi/ver
RMS error 0.124794 pixels with polynomial ord
Resampling image /vol/atlanta/root/imagi/ex
Computing stats of /usr/data/lnc lump_reproj.i
10/21/1999 15:10:23 reprojectprocess complete

10/21/1999 15:10:23 /vol/products/imagi/ver
RMS error 0.124794 pixels with polynomial ord
Resampling image /vol/atlanta/root/imagi/ex
Computing stats of /usr/data/l ninspect_reproj.
10/21/1999 15:10:35 reprojectprocess complete

10/21/1999 15:10:35 /vol/products/imagi/ver
RMS error 0.124794 pixels with polynomial ord
Resampling image /vol/atlanta/root/imagi/ex
Computing stats of /usr/data/lndem_reproj.img
10/21/1999 15:10:44 reprojectprocess complete

10/21/1999 15:10:44 /vol/products/imagi/ver
RMS error 0.124794 pixels with polynomial ord
Resampling image /vol/atlanta/root/imagi/ex
Computing stats of /usr/data/l nhydro_reproj.i
10/21/1999 15:10:53 reprojectprocess complete

10/21/1999 15:10:53 /vol/products/imagi/ver
RMS error 0.124794 pixels with polynomial ord
Resampling image /vol/atlanta/root/imagi/ex
```

### Execute Multiple Files/Multiple Commands

This procedure is most useful for very complex operations on multiple files involving many commands where the output from one command becomes the input to a succeeding command. In the following example, you are going to perform three operations on each of the Lake Lanier related files in the ERDAS IMAGINE examples directory.



*It is important to note that some processes depend upon the physical extents of the imagery, or the number of bands, or data types, etc. You must be aware of both the requirements of the processes (commands) as well as the differences between the file types to be processed. In many cases, the data sets provided to multifile processing jobs must share common physical and ephemeral aspects.*

### Set Up

1. Select **Session | Preferences** from the ERDAS IMAGINE menu bar to open the Preference Editor dialog, and select the **Batch Processing** category.



## Batch Processing

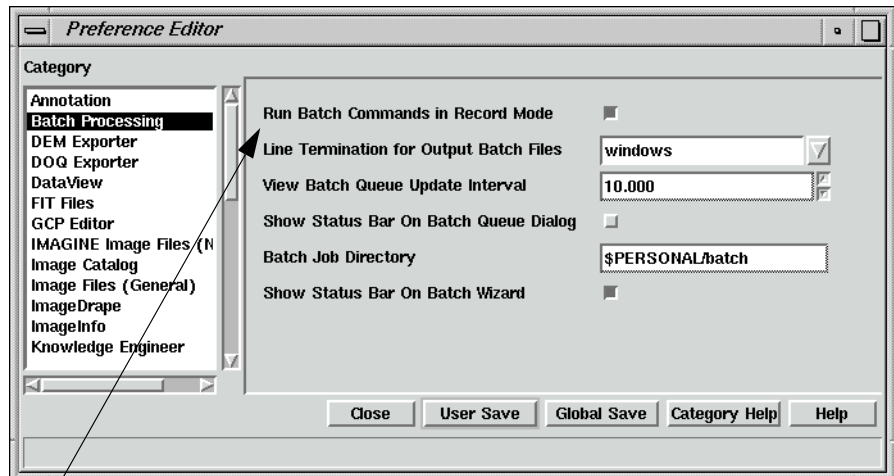

*Batch commands should run in record mode*

2. Ensure that the **Run Batch Commands in Record Mode** option is enabled (checkbox checked).

This preference tells ERDAS IMAGINE to run the commands and record them simultaneously. When running in Record Mode, you are typically collecting a series of commands to automate. Since the first command typically produces input for the next command, it is desirable to have the command run as soon as it is placed into the current list of commands.

Once the command has completed, the resulting file is available to be selected as input to the next command. In this case, the **Create and Insert Variables** button can be used to identify and replace intermediary files with temporary file variables, so that only the final output file is left on disk, and not all of the intermediate steps.

Optionally, you can select the **Run commands as they are recorded** checkbox on the **Record Commands for Automation** panel. This sets the preference for the current session without changing your general preferences.

3. In the Preference Editor, click the **Image Files (General)** category, then click to deselect the **Compute Pyramid Layers** option. You do not want pyramid layers to be generated for the temporary files. Rather, you can run the Image Command Tool as a Batch process to create pyramid layers for the output files only.
4. Click **User Save** in the Preference Editor, then click **Close**.
5. Select **Session | Start Recording Batch Commands** from the ERDAS IMAGINE menu bar to start the Batch Wizard. The **Record Commands for Automation** panel displays.

Note that the flashing record light, located in the lower left corner of the Batch Wizard dialog, has been activated.

## Execute Multiple Files/Multiple Commands

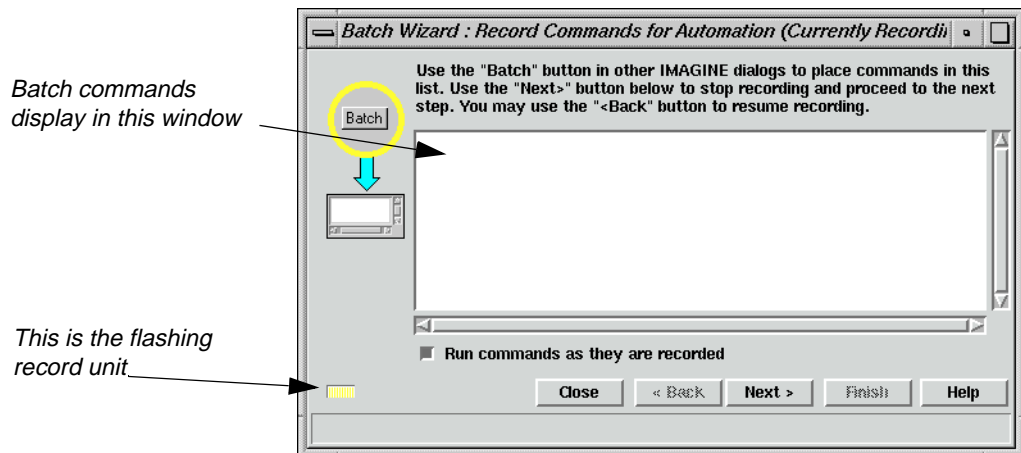

### Run First Command

1. From the ERDAS IMAGINE icon bar, click the **Interpreter** icon and then select **Radiometric Enhancement | Histogram Equalization** to open the Histogram Equalization dialog.
2. Select <IMAGINE\_HOME>/examples/lanier.img for the **Input File** name and <your\_workspace>/image1.img for the **Output File** name.

Where <your\_workspace> is the **Default Output Directory** specified in the **User Interface & Session** category in the Preference Editor and <IMAGINE\_HOME> is the directory where ERDAS IMAGINE is installed.

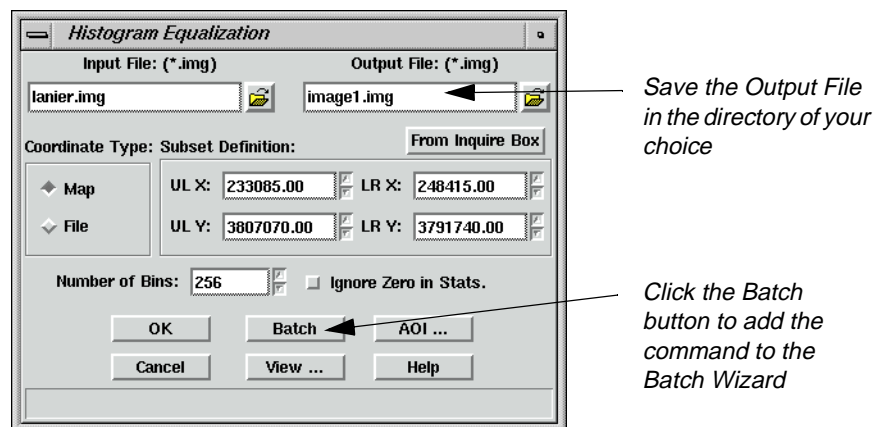

3. Click the **Batch** button in the Histogram Equalization dialog. The command to perform histogram equalization is added to the **Record Commands for Automation** panel. The histogram equalization process starts and a Job Status dialog displays. When the process is done, click **OK**.

### Run Next Command

1. To open the Brightness Inversion dialog, select **Brightness Inversion** from the **Radiometric Enhance** menu you opened in the first command.



# Batch Processing

2. Select <your\_workspace>/image1.img for the **Input File** name and <your\_workspace>/image2.img for the **Output File** name. The **Batch** option is now enabled.

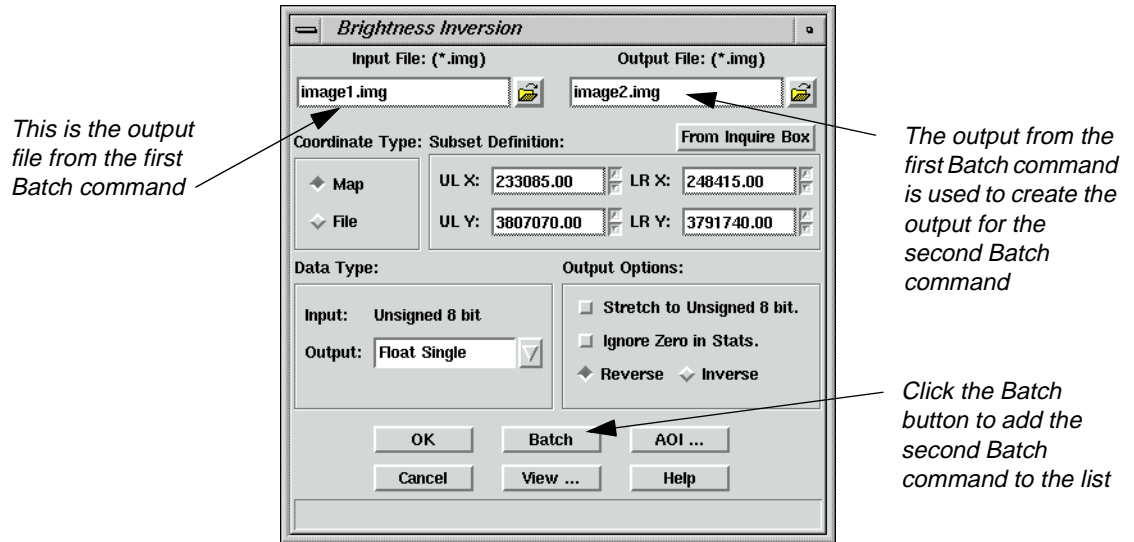

3. Click the **Batch** button. The command to perform brightness inversion is added to the **Record Commands for Automation** panel. The histogram brightness inversion starts and a Job Status dialog displays. When the process is done, click **OK**.

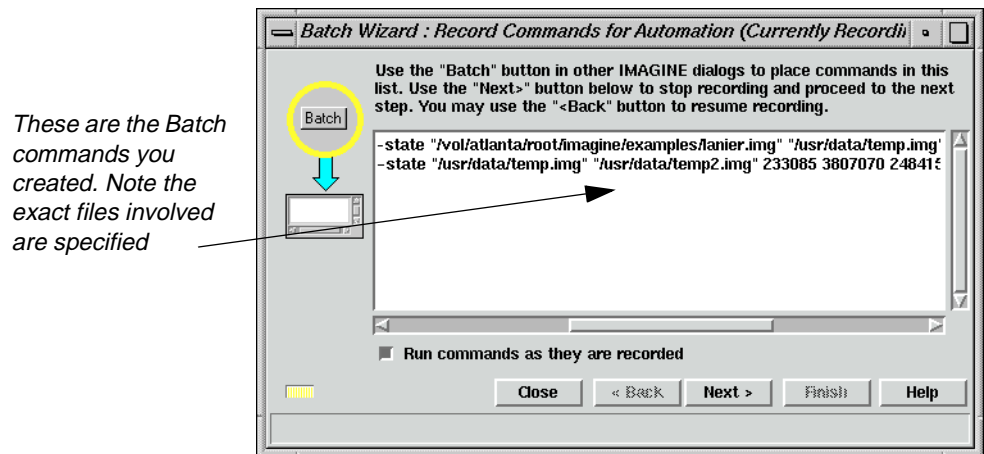

## Run Another Command

You can also use Batch to create pyramid layers of your data. Now you instruct the Image Command Tool to create pyramid layers for the output files only.

1. From the **Tools** menu of the ERDAS IMAGINE menu bar, select **Image Command Tool**. In the **Image File** window of the Image Commands dialog, select the file you generated in the last example, **image2.img**.

## Execute Multiple Files/Multiple Commands

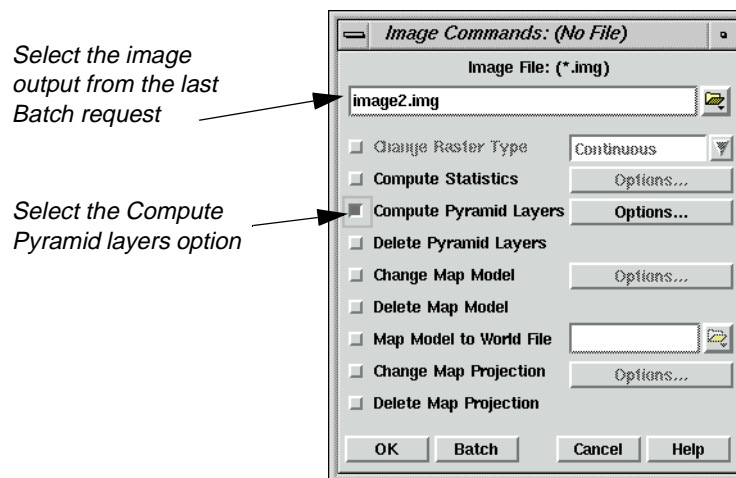

2. Click the **Compute Pyramid Layers** checkbox, then click the **Options** button next to **Compute Pyramid Layers** to open the Pyramid Layers Options dialog. Notice the **Kernel Size**, and that the **External File** option is not checked. You want the output file to contain internal pyramid layers rather than having the pyramid layers stored in an external .rrd file. Click **OK** in the Pyramid Layers Options dialog.

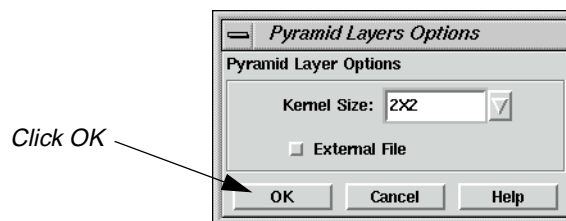

3. Click the **Batch** button in the Image Commands dialog. The command to create pyramid layers is added to the **Record Commands for Automation** panel. The pyramid layer generation starts and a Job Status dialog displays. When the process is done, click **OK**.

If you examine the contents of the **Record Commands for Automation** panel at this time, you notice that the commands explicitly name the input and output files. The next procedure converts the input and output file names into variables so that these commands may be applied to a larger set of input files.

### Create Variables

1. On the **Record Commands for Automation** panel, click the **Next >** button. The **Select Type of Command Processing** panel displays. Select the **Modify commands automatically** option.
2. On the **Select Type of Command Processing** panel, click the **Next >** button. The **Edit Commands/Create Variables** panel displays.



# Batch Processing

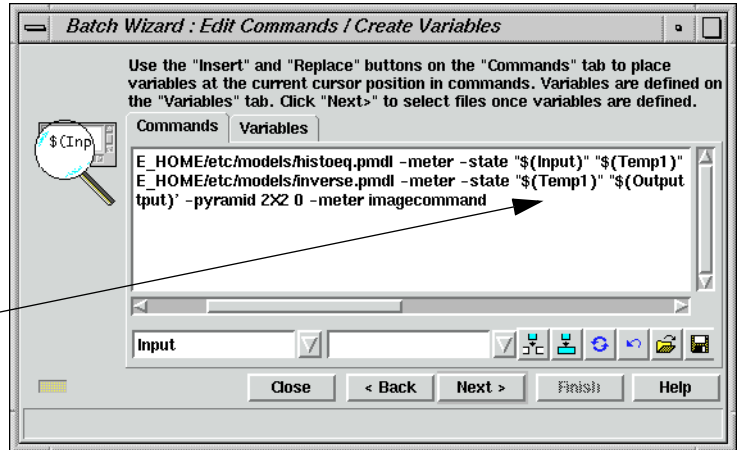

Now, the files have been replaced by variables: Input, Temp1, and Output

## Modify Variables

This procedure creates an intermediate file that is used to pass the output of the first process to the input of the second. There is no need to keep this file and use disk space. Also, you might want the output file name to be a little more meaningful than **image2**. The following steps tell you how to modify variables.

1. Click the **Variables** tab to gain access to the variable editing tools.

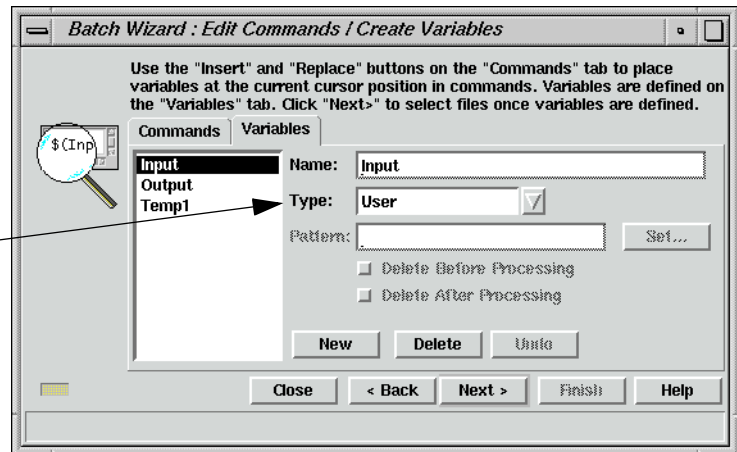

The Input variable is defined by you

The **Input** variable is of type **User**. This means that you provide the names of the input files. This is accomplished in subsequent steps using the **Select Files to Process** panel.

2. Select the **Temp1** variable. This represents the intermediate files that are not needed after processing. The **Delete Before Processing** checkbox is automatically selected to remove these files before processing begins. This prevents problems arising from the existence of an old file. The **Delete After Processing** checkbox is also automatically selected to remove these temporary files when processing finishes.



## Execute Multiple Files/Multiple Commands

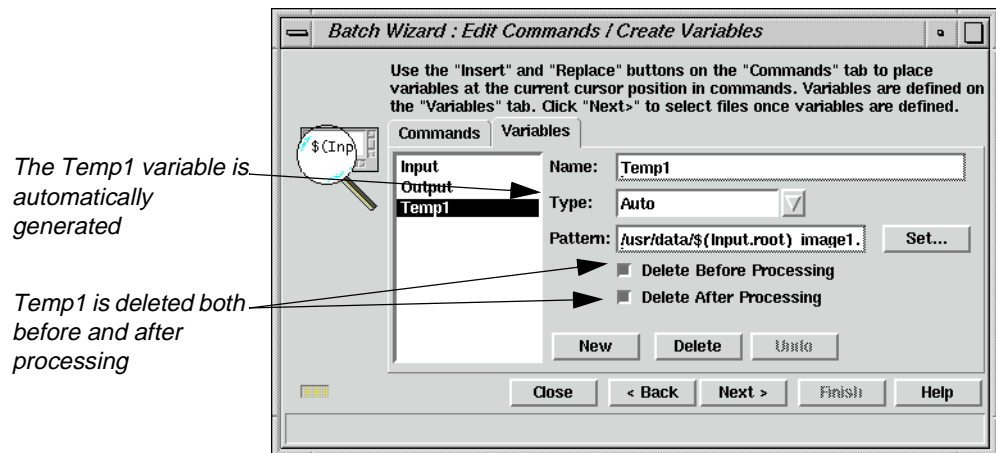

3. Select the **Output** variable. This represents the name of the final output file. The **Delete Before Processing** checkbox is checked automatically to remove these files before processing begins. This prevents problems arising from the existence of an old file.

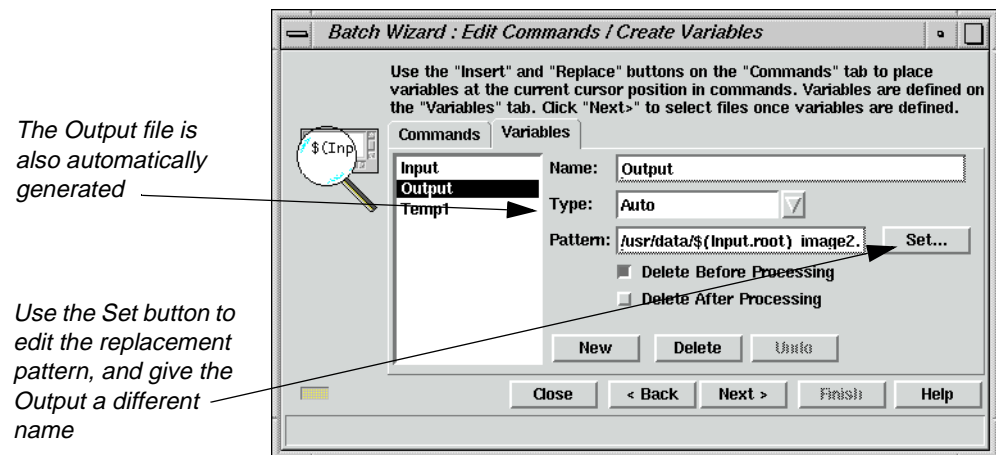

Notice that the **Output** variable as well as the **Temp1** variable described above are of the **Type Auto**. This means the software is responsible for creating the file names that are substituted for the variables at run time.

By default, the software uses the output directory that you specified in step 2. under Execute Multiple Files/Multiple Commands on page 197. For the file name, it uses a combination of the root name of the input file and the last specified output file (in this example, **image2**).

4. Click the **Set** button. Click in the **Pattern** window and edit the text string to change **image2** to **inverse**, and then click **OK**.



## Batch Processing

Change this portion of the Pattern to the new name: inverse

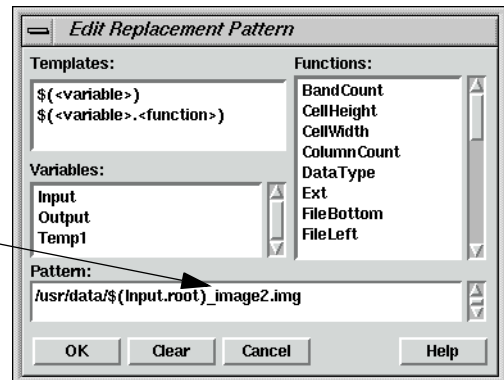

*NOTE: If your input files have the same root name (e.g., 03807701.nec, 03807701.nwc) change **Input.root** to **Input.name** in the **Pattern** window. This includes the extension and thus preserves the uniqueness of the file name.*

### Select Input Files

1. Click the **Next >** button to open the **Select Files to Process** panel. The original input file is listed in the **Input** column.
2. Click the Add Files button. The Select Batch Files dialog opens.



3. Select **Inaspect.img** from the Select Batch Files dialog. Click the **Multiple File Selection** tab and click the **Use the following Selection Pattern** checkbox. Edit the **Selection Pattern** field to insert **ln** before the asterisk. It should look like this:

```
<IMAGINE_HOME>/examples/ln*.img
```

Where <IMAGINE\_HOME> represents the ERDAS IMAGINE installation directory.

## Execute Multiple Files/Multiple Commands

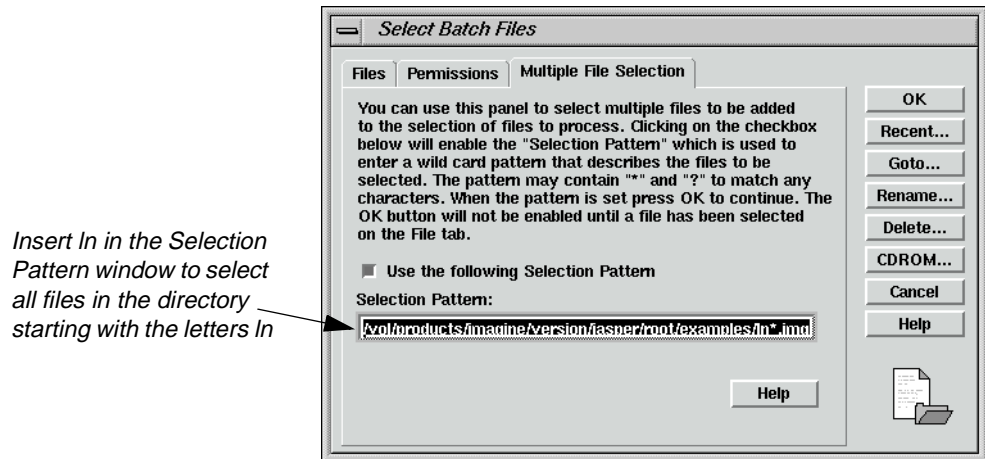

4. Click the **OK** button on the Select Batch Files dialog.

The input files are displayed under the **Input** column. Select and delete any duplicate or unwanted files by clicking in the numbered column next to the file name and then clicking the Delete Files icon. This list of input files may be saved for future use.



See “Additional Information” on page 209 for details on how to save lists of input files.

### Set Start Time

1. Click the **Next >** button to open the **Select When to Process Commands** panel. Click the **Start Processing Later At** checkbox. Use the default time of the next available minute.
2. Click the **Finish** button to begin processing. The Scheduled Batch Job List dialog opens, displaying all current Batch jobs.

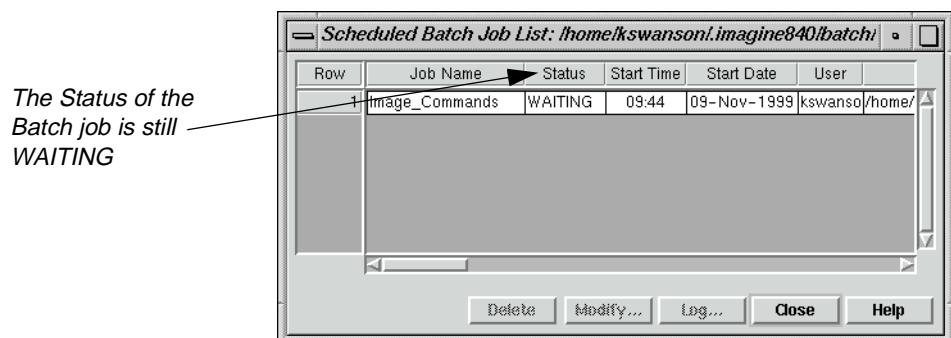

When the job begins, the **Status** changes from **WAITING** to **ACTIVE**. When the job has finished, the **Status** changes from **ACTIVE** to **DONE**.



# Batch Processing

When the job is done, the log file can be viewed by first selecting the job and then clicking the **Log** button in the Scheduled Batch Job List dialog.

The Scheduled Batch Job List dialog may be opened any time by selecting **Session | View Off-line Batch Queue** from the ERDAS IMAGINE menu bar.

3. When the Batch jobs are finished, indicated by **DONE** in the **Status** column, click **Close** in the Scheduled Batch Job List dialog.

If you wish, you can check the files you just generated in a Viewer.

*NOTE: You may also wish to change your preferences back to the default of **Compute Pyramid Layers** in the **Image Files (General)** category of the Preference Editor.*

---

## Work with Variables

This section deals with modification of automatically created variables for the purpose of generalizing a command file.

### Create a New Variable

A new variable is helpful in the case of an application requiring multiple inputs. The automatically created variables always consist of a single **Input**, a single **Output**, and as many **Temp** variables as necessary. If you are creating a Batch command file that can be used by others, it is much more readable if the **Temp** variables are replaced by variable names that are meaningful.

When creating variables, it is important to know the distinction between **User** variables and **Auto** variables. The value of a **User** variable is derived from the **Select Files to Process** panel. You must provide the appropriate value for each **User** variable in the CellArray.

The value of an **Auto** variable is generated by the software from parameters specified in the pattern window of the **Set** dialog. If you recall, you worked with the dialog generated by pressing the **Set** button, the Edit Replacement Pattern dialog in "Modify Variables" on page 200.

In the following example, you are going to create a variable, **OutputDir**, which enables another person to enter an output directory of his or her choice for files processed by Batch. For this exercise, you have selected a number of files that you want to reproject.

### Prepare

First, you have to start the application from which you launch the Batch Wizard.

ERDAS IMAGINE must be running.

1. Click the Interpreter icon. From the **Image Interpreter** menu, select **Utilities**. From the **Utilities** menu, select **Subset**.

The Subset dialog opens.



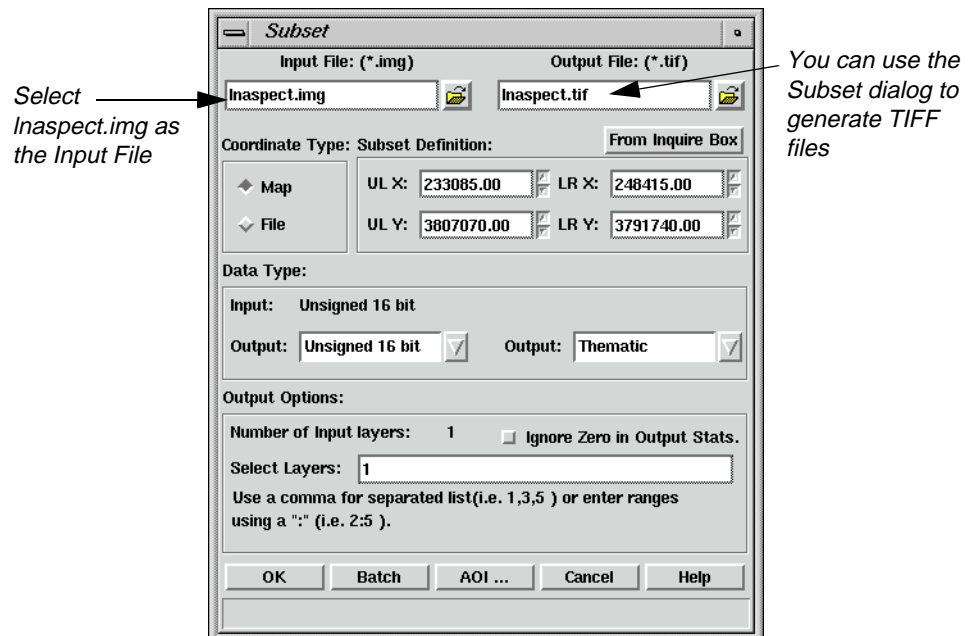

2. In the Subset dialog, click the Open icon underneath **Input File**. In the Input File dialog, navigate to the <IMAGINE\_HOME>/examples directory. Choose the file **Inaspect.img** from the /examples directory. Click **OK** in the Input File dialog to transfer the file to the Subset dialog.
3. Click the Open icon underneath **Output File**. In the Output File dialog, navigate to the directory of your choice. Click the **File Type** dropdown list and select **TIFF**. In the **Filename** window, type **Inaspect**, then press Return on your keyboard. The .tif extension is appended automatically. Click **OK** in the Output File dialog.

### Start Batch Wizard

1. Click the **Batch** button in the Subset dialog.
2. In the **Select Type of Command Processing** panel of the Batch Wizard dialog, click the **Modify commands automatically** checkbox. Then, click **Next >**.

The **Edit Commands/Create Variables** panel displays.



# Batch Processing

The Input and Output variables are automatically assigned

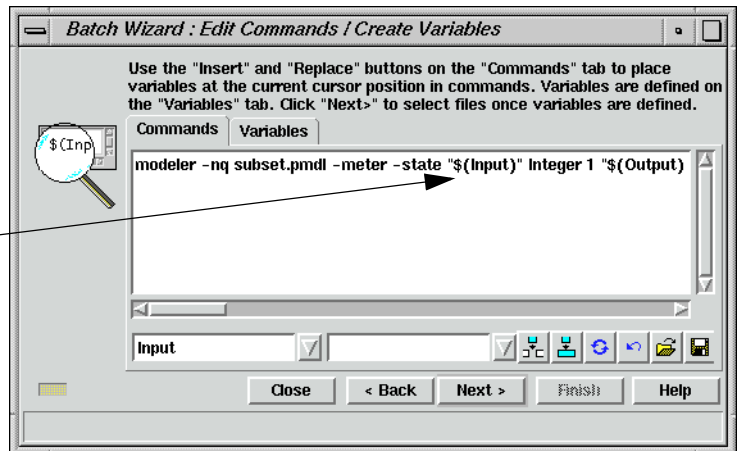

3. Click the **Variables** tab on the **Edit Commands/Create Variables** panel. Click on the **Output** variable to observe its properties.

Click the Output variable to observe its properties

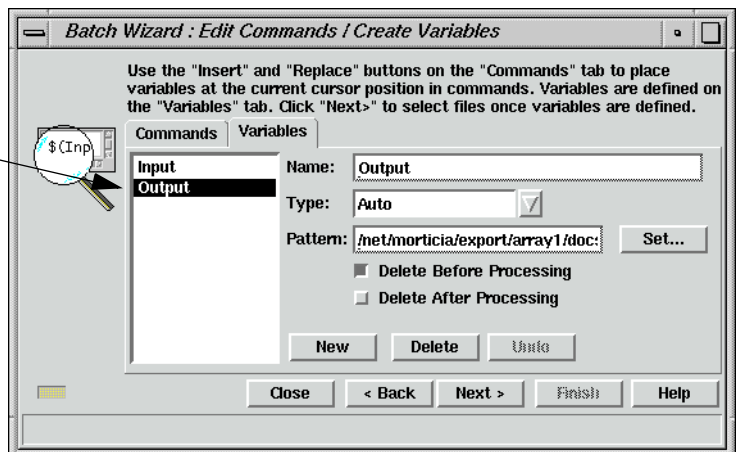

Notice in the **Pattern** window of the **Variables** tab that the path to the **Output** file is so long that it does not completely fit within it. This directory can be replaced with a new variable called **OutputDir**. You can set the **Pattern** of the **OutputDir** variable to any directory you choose. This makes your command shorter.

## Create a New Variable

Since you know that you want your new variable to be named **OutputDir**, and you know you want it to replace the current path in the **Pattern** of the **Output** variable with it, you can begin editing there.

1. Make sure that the **Variables** tab displays the **Output** variable's details.
2. Click in the **Pattern** window and remove the entire directory structure you want to replace. Once you have eliminated it, type in the following:

`$(OutputDir)`



Your **Pattern** window then looks like the following:

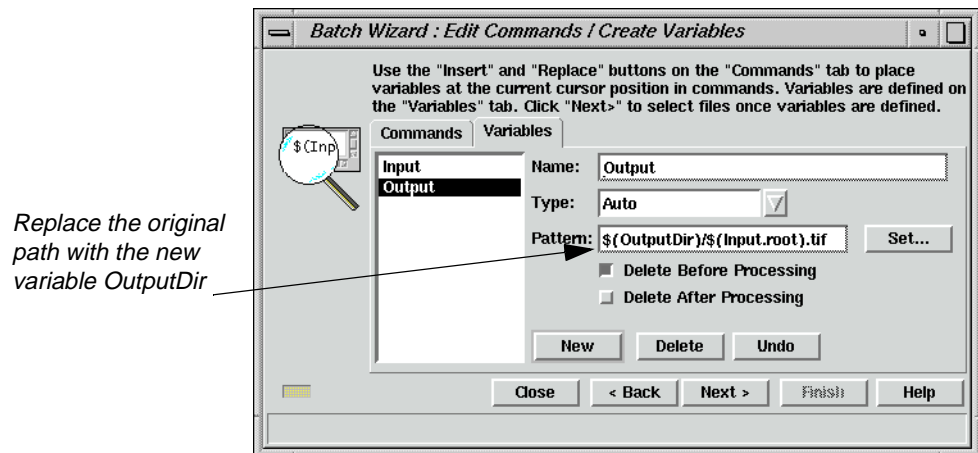

You have to create the new variable, **OutputDir**, so that the variable **Output** does not generate errors in your Batch script, and knows where to place output files.

3. In the **Variables** tab of the **Edit Commands/Create Variables** panel, click the **New** button.

The **Variables** tab changes to accommodate a new variable.

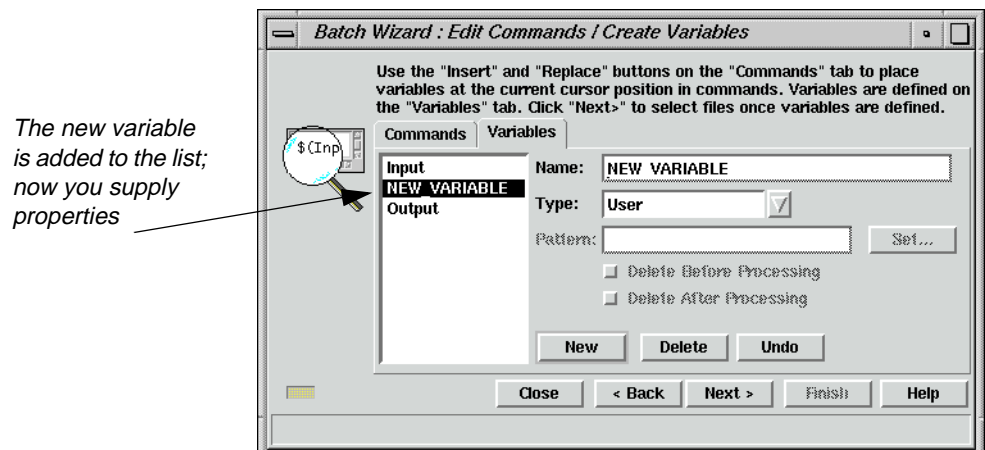

4. In the **Name** section of the **Variables** tab, type the name **OutputDir**.
5. Click the **Type** dropdown list and choose **Auto**.
6. In the **Pattern** window, type the path to the directory and folder that you want generated files to be saved in.

Your **Variables** tab looks like the following:



# Batch Processing

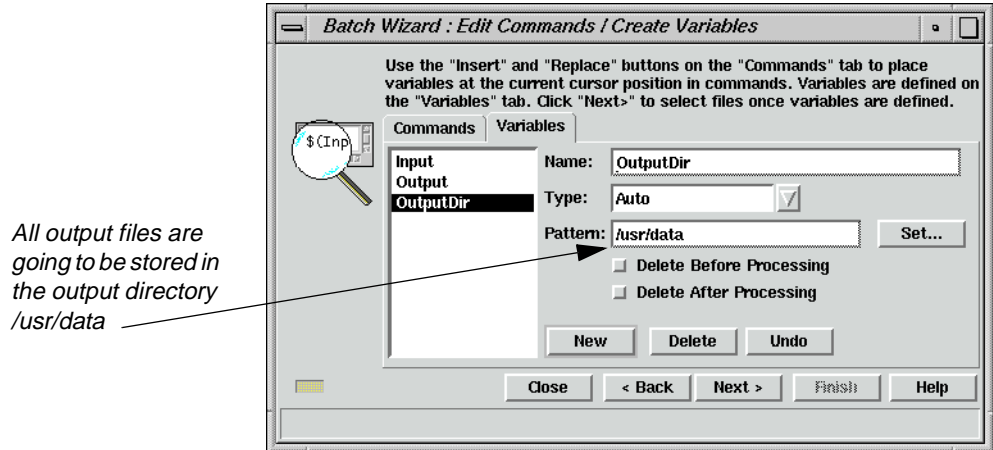

## Add Additional Files to the Batch Job

1. Click **Next >** in the **Edit Commands/Create Variables** panel.
2. In the **Select Files to Process** panel, click the Select Files to Add button, and add all files with in the <IMAGINE\_HOME>/examples directory that start with the letters **In** using the **Multiple File Selection** tab.



If you need to review how to add multiple files, see "Add Multiple Files" on page 192.

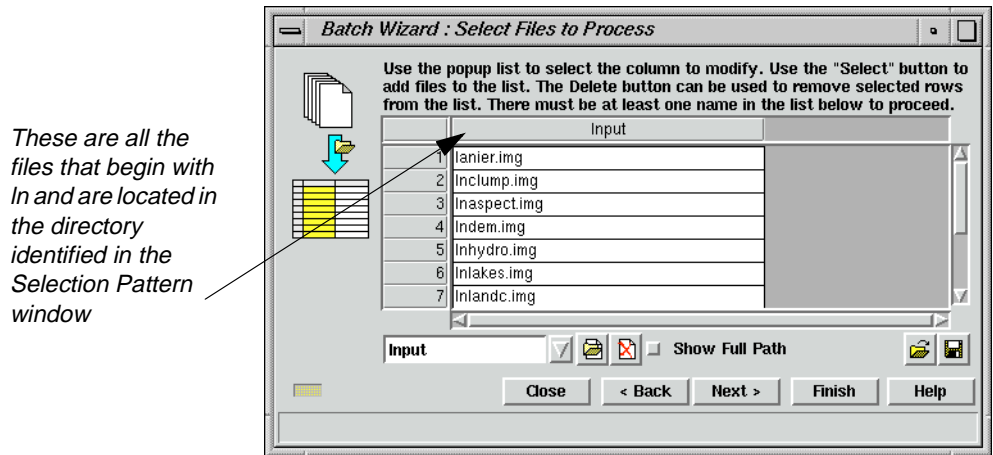

## Start Processing

1. Click the **Next >** button to open the **Select When to Process Commands** panel.
2. Make sure the **Start Processing Now** option is selected, then click **Finish** to start the Batch job with the new variable.

The double Job Status dialog opens.





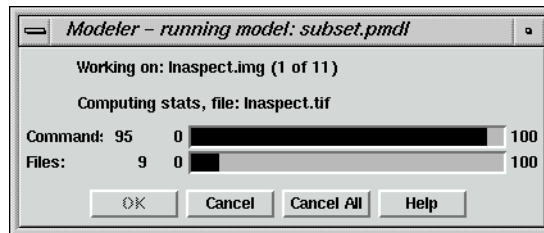

3. When the process completes, click **OK** in the Job Status dialog.

### Check the Output Directory

Now, you can check the output directory to see the files that have been stored there. In this example, the directory holds TIFF files you created from image files using the Subset utility of Image Interpreter.

1. Using a UNIX shell or Microsoft Explorer, navigate to the directory you specified as the Output Directory.
2. Check for the new TIFF files created from all files starting with **In** in the <IMAGINE\_HOME>/examples directory.

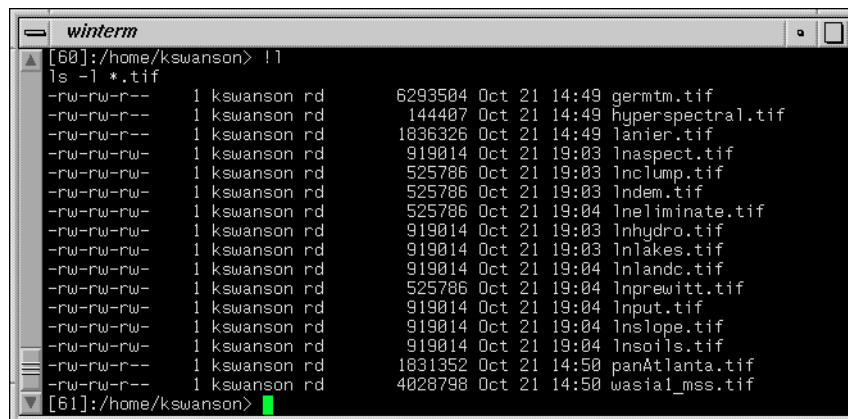

### Additional Information

#### Save/Load Options

The **Edit Commands / Create Variables** panel and the **Select Files to Process** panel provide methods for saving and loading the Batch commands and input file lists, respectively.

#### Save

Click the Save icon to save the commands in the **Edit Commands/Create Variables** panel to a text (.bcf) file, and the input file list in the **Select Files to Process** panel to a text (.bls) file for later use. The Save Batch Commands dialog opens, allowing you to enter a new file name.



# Batch Processing



## Load

Click the Load icon to load a previously saved command (.bcf) file or input file list (.bls) file. A Load Batch Commands dialog opens, allowing you to select from a previously saved list of files. These lists are text files that may be created outside of ERDAS IMAGINE.



## Batch Job Files

Several files are created for each Batch job that runs at a later time. The default file name root is **batch\_job**. The file name can be seen in the **Name** field of the **Select When to Process Commands** panel. File names for each Batch job are listed in the Scheduled Batch Job List dialog.

## PC Version

The following are PC versions of Batch job files that are located in the Batch job directory. The default Batch job directory is **\$PERSONAL/batch**, and you can go to **Session | Preferences | Batch Processing** to change the **Batch Job Directory**.

- **batch\_job.bat**—This is an MS-DOS Batch file. This file sets up the environment for the ERDAS IMAGINE applications and runs “batchprocess,” which runs the commands found in the **batch\_job.bcf** file.
- **batch\_job.bcf**—These are ERDAS IMAGINE Batch command files. These files hold the variable definitions and issue the ERDAS IMAGINE commands to perform the step, or steps, required to complete a job.
- **batch\_job.bls**—These files contain lists of input files.
- **batch\_job.id**—This file contains a job number assigned by the system. This file is deleted automatically to indicate completion of the job.
- **batch\_job.lck**—This is an empty file that is created when the job actually starts running. This indicates the job is **ACTIVE**. When the job is done, it is deleted.
- **batch\_job.log**—This file contains the results of the Batch job.

### UNIX Version

These are UNIX versions of Batch job files:

- **batch\_job.bcf**—These are ERDAS IMAGINE Batch command files. These files hold the variable definitions and issue the ERDAS IMAGINE commands to perform the step, or steps, required to complete a job.
- **batch\_job.blc**—These files contain lists of input files.
- **batch\_job.id**—This file contains a job number assigned by the system. This file is deleted automatically to indicate completion of the job.
- **batch\_job.job**—This is a UNIX shell script. This file sets up the environment for the ERDAS IMAGINE applications and runs “batchprocess,” which runs the commands found in the **batch\_job.bcf** file.
- **batch\_job.lck**—This is an empty file that is created when the job actually starts running. This indicates the job is **ACTIVE**. When the job is done, it is deleted.
- **batch\_job.log**—This file contains the results of the Batch job.



# Batch Processing



# *Section II*

## *IMAGINE Advantage™*



## Section II IMAGINE Advantage™



# CHAPTER 10

## Fourier Transform Editor

---

### Introduction

In this tour guide, you enhance and destripe a  $512 \times 512$  subset of a Landsat Thematic Mapper image using both interactive and automatic methods available in the ERDAS IMAGINE Fourier Analysis tools.

Not all of the edits in this tour guide necessarily enhance the image. Many exercises are performed simply to show you how they affect the image. When you use these techniques on other data sets, you may want to experiment with different methods, or combinations of methods, to find the techniques that work best.



---

*It is highly recommended that you read the Fourier Analysis section, beginning on page 183 of the ERDAS Field Guide, before going through this tour guide.*



---

*If you are a new to ERDAS IMAGINE, it is recommended that you go through the tour guide "CHAPTER 1: Viewer" before using the Fourier Transform Editor.*



---

*Approximate completion time for this tour guide is 45 minutes.*

---

### Create an .fft Layer

In order to use the Fourier Transform Editor, you must first create a Fourier Transform (.fft) layer from the input image.

#### Prepare

ERDAS IMAGINE must be running and you must have a Viewer open.

#### Display File

1. Select **File | Open | Raster Layer** from the Viewer menu bar.

The Select Layer To Add dialog opens.



# Fourier Transform Editor

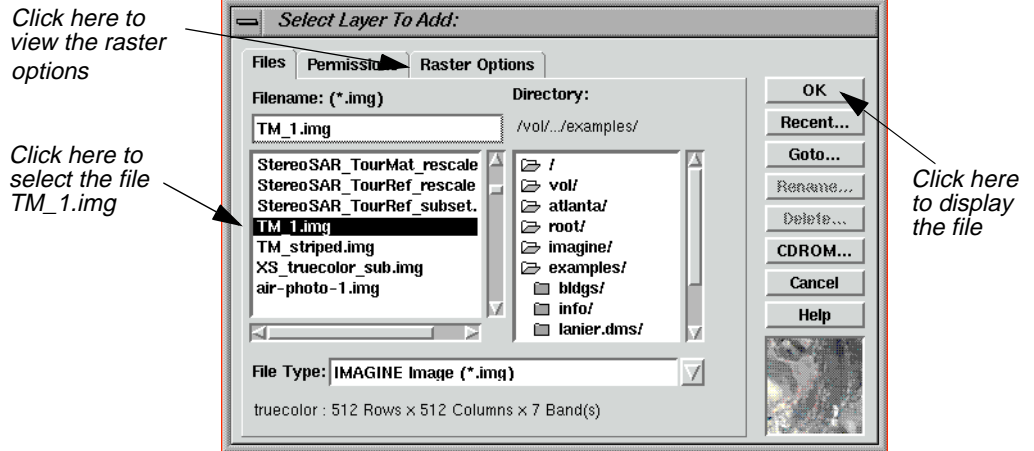

2. In the Select Layer To Add dialog under **Filename**, click on **TM\_1.img**.
3. Click on the **Raster Options** tab at the top of the dialog and then select **Gray Scale** from the **Display as** popup list.
4. The **Display Layer** section updates so that you can select which layer of the file to display. Accept the default of **Layer 1**.
5. Click **OK** to display the image file in the Viewer.

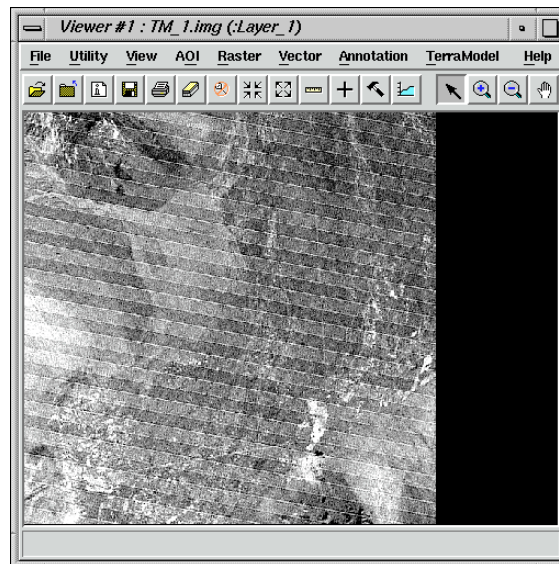

*NOTE: You do not have to display a file before computing the .fft layer. This step is included to show you the image before any Fourier editing is performed.*



6. Click the Image Interpreter icon on the ERDAS IMAGINE icon panel.



The **Image Interpreter** menu displays.

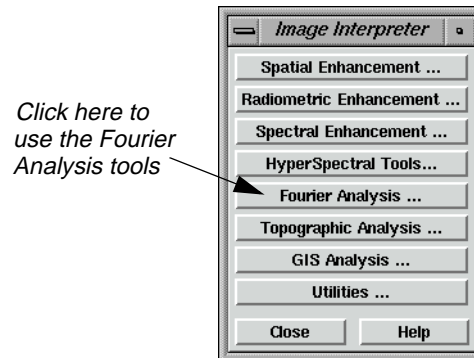

7. Select **Fourier Analysis** from the **Image Interpreter** menu.

The **Fourier Analysis** menu opens.

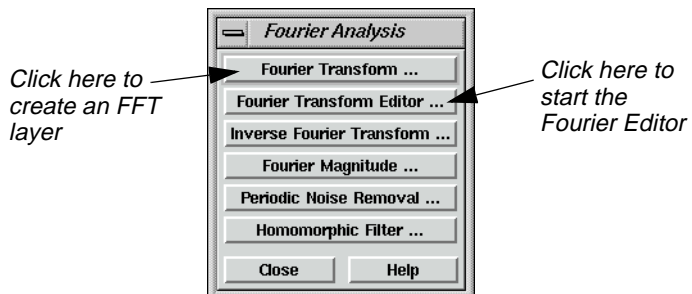

8. Select **Fourier Transform** from the **Fourier Analysis** menu.

The Fourier Transform dialog opens.



## Fourier Transform Editor

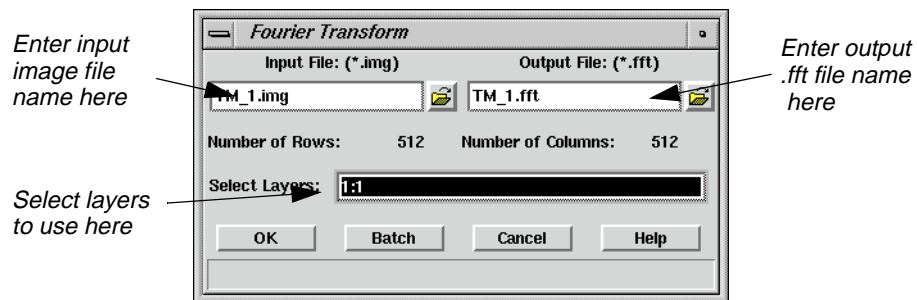

9. In the Fourier Transform dialog under **Input File**, type in **TM\_1.img**.

Layer 1 of this file is badly striped. In this example, you work with only one layer to make the processing go faster. However, the techniques you use are applicable to multiple layers.

10. The name for the **Output File**, **TM\_1.fft**, is automatically generated. Make sure it is in a directory in which you have write permission. The default is your default data directory set by **Session | Preferences**.
11. Enter **1:1** in the **Select Layers** field.
12. Click **OK** in the Fourier Transform dialog to create the new file.

A Job Status dialog displays, showing the progress of the function. When the process is 100 percent complete, click **OK**.

---

### Start the Fourier Transform Editor

With the .fft file created, you are ready to begin using the Fourier Transform Editor.

1. In the **Fourier Analysis** menu, select **Fourier Transform Editor**.

The Fourier Editor opens.

## Start the Fourier Transform Editor

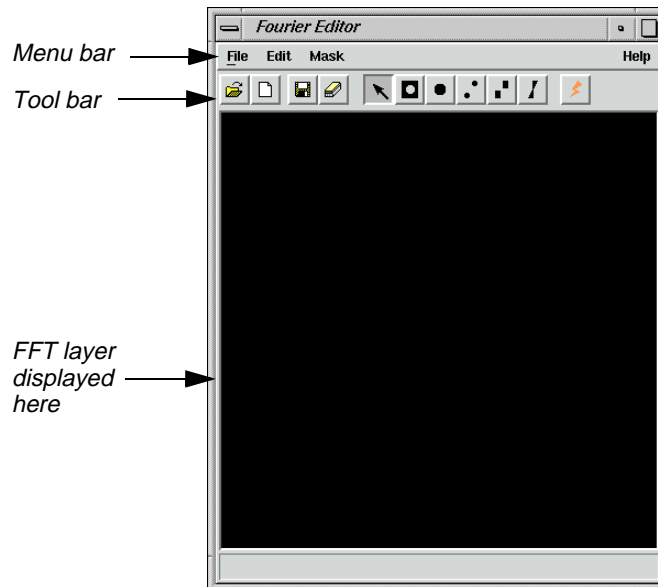

2. In the Fourier Editor, click the Open icon on the tool bar, or select **File | Open** from the menu bar.



The Open FFT Layer dialog opens.

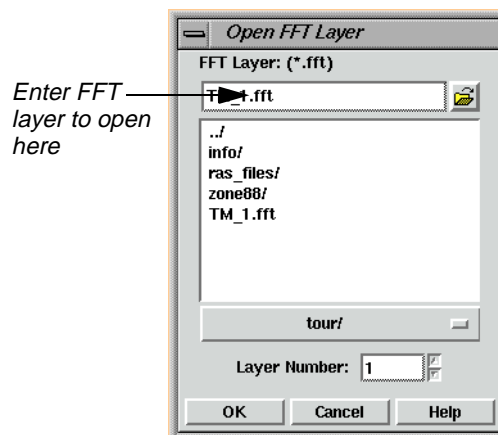

3. In the Open FFT Layer dialog under **FFT Layer**, enter the path and name of the .fft layer you created in steps (9. through (10. on page 218 (e.g., **TM\_1.fft**).

Since this file contains only one layer, the **Layer Number** defaults to **1**. However, if the file contained more than one layer, you could choose the layer to edit here. Edits performed on one layer can be applied to all layers of the .fft file using the **File | Save All** option on the Fourier Editor menu bar.



## Fourier Transform Editor

4. Click **OK** to display the selected file in the Fourier Editor.

A status meter opens as the layer is read. Then the layer is displayed.

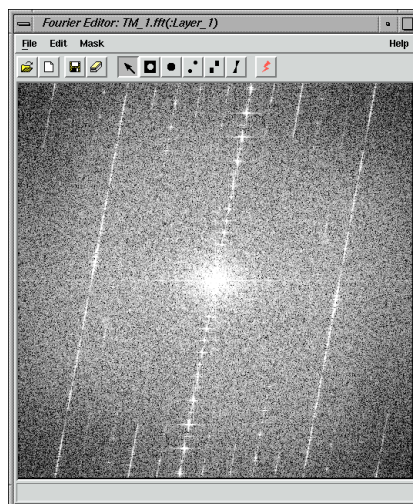

You can resize the Fourier Editor window to see the entire file.

5. Click on any point inside the Fourier Editor and the coordinates of that point are shown in the status bar. Hold and drag to dynamically update the coordinates.

### Fourier Editor Coordinates

The coordinates are referred to as  $(u,v)$  with the origin  $(u,v = 0,0)$  at the center of the image. See the illustration below.

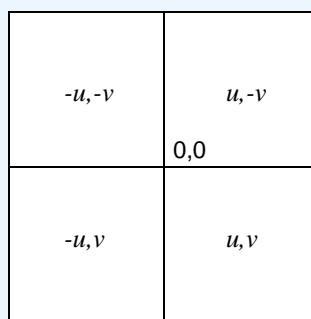

Since Fourier images are symmetrical, a point in one quadrant is exactly the same as the corresponding point in the opposite quadrant. For example, point  $(64,170)$  is the same as point  $(-64,-170)$ . For this reason, all edits are automatically performed on both halves of the image at the same time.

## Edit Using Menu Options

As previously stated, the menu bar and mouse-driven tools offer the same techniques and kinds of edits, only the method is different. In the menu bar options, you enter all parameters into dialogs. In many cases you want to use the mouse to view the coordinates of the .fft layer, so that you know what information to enter into the dialogs. In the next series of steps, you use some of the menu bar editing options. Then, in the next section, you perform many of those same edits using the mouse-driven tools.

## Use Low-Pass Filtering

Low-pass filtering allows you to attenuate the high-frequency components of the image, but allows the low-frequency components to pass through.

1. Select **Mask | Filters** from the Fourier Editor menu bar.

The Low/High Pass Filter dialog opens.

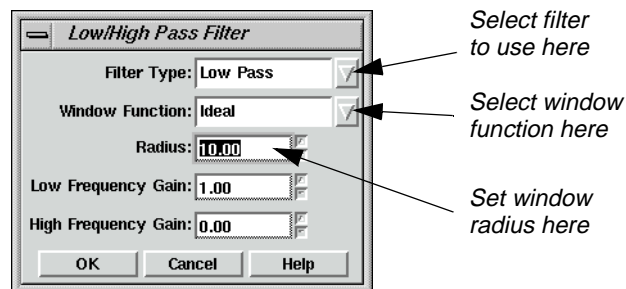

### Filter Types

When the **Filter Type** is set to **Low Pass**, its function is the same as the Low Pass Filter icon on the tool bar.



When the **Filter Type** is set to **High Pass**, its function is the same as the High Pass Filter icon on the tool bar.



You use these mouse-driven tools later in this tour guide.

2. In the Low/High Pass Filter dialog, click on the **Window Function** popup list and select **Ideal**.

An ideal window function produces a sharp transition at the edge of the filter.



## Fourier Transform Editor

3. Change the **Radius** to **10.00**.
4. Leave all other parameters as is and click **OK**.

A low-pass filter is applied to all values outside of the radius of 10.00. Therefore, the image is black, except for a small white circle in the center.

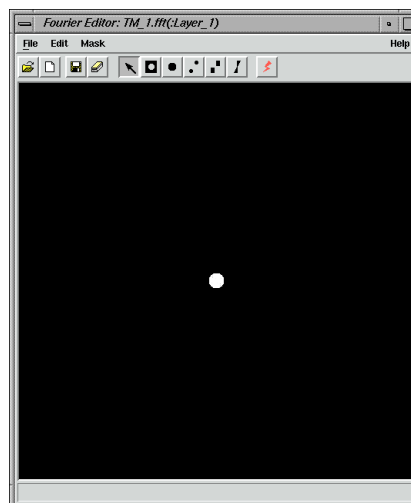

Removing this much of the layer removes much of the content of the image, so you may want to undo this edit and try again.

5. Select **Edit | Undo** from the Fourier Editor menu bar.

The image is restored to its original state.

### Select a Different Filter

1. Select **Mask | Filters**.
2. In the Low/High Pass Filter dialog, click on the **Window Function** popup list and select **Ideal**.
3. Enter a **Radius** of **80.00**.
4. Click **OK** in the Low/High Pass Filter dialog.

All frequencies outside the radius of 80 are attenuated and frequencies inside the radius are unaffected. The .fft layer looks similar to the following example:

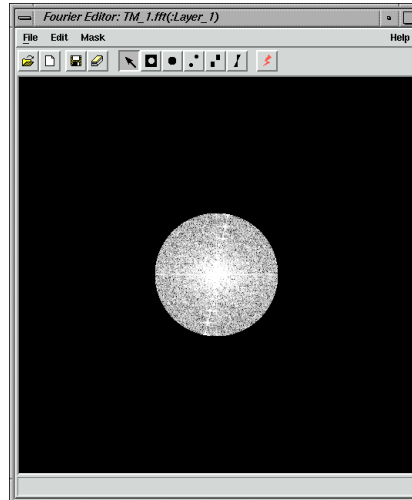

### Save the File

1. Select **File | Save As** from the Fourier Editor menu bar.

The Save Layer As dialog opens.

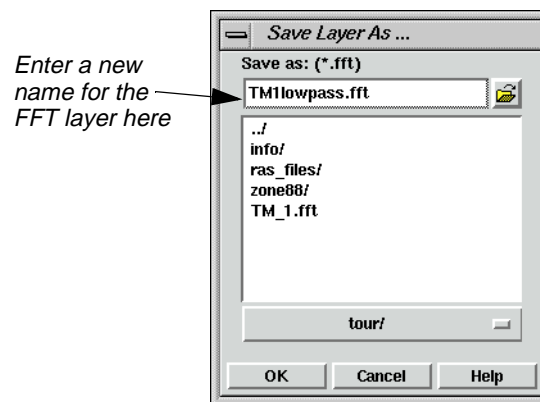

2. In the directory of your choice, enter a name for the new .fft layer, such as **TM1lowpass.fft**.
3. Click **OK** to save the file.

### Apply an Inverse Fourier Transformation

Now, perform an inverse Fourier transformation so that you can view the original image and see what effect this edit had on it.



*You must save your edits before performing an Inverse Transform Operation.*



## Fourier Transform Editor

1. In the Fourier Editor, click the Run icon on the tool bar or select **File | Inverse Transform** from the menu bar.



The Inverse Fourier Transform dialog opens.

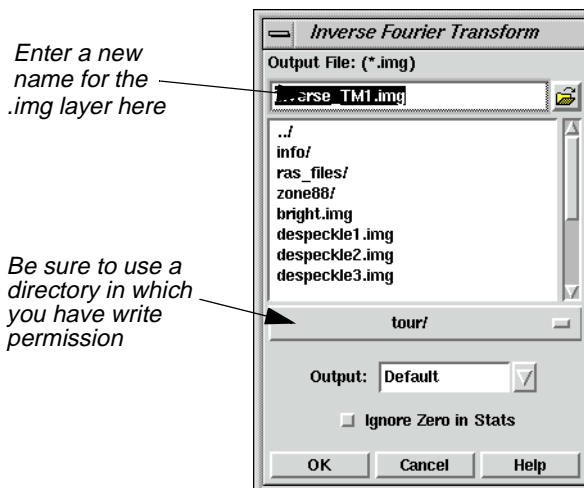

2. In the Inverse Fourier Transform dialog under **Output File**, enter a name for the new output file, such as **inverse\_TM1.img**. This file has an **.img** extension by default. Be sure to use a directory in which you have write permission.
3. Click **OK** to create the new file.

A Job Status dialog displays, indicating the progress of the function.

4. When the Job Status dialog indicates that the file is created, click **OK** and then display the file in a Viewer.

Your file should look similar to the following example:



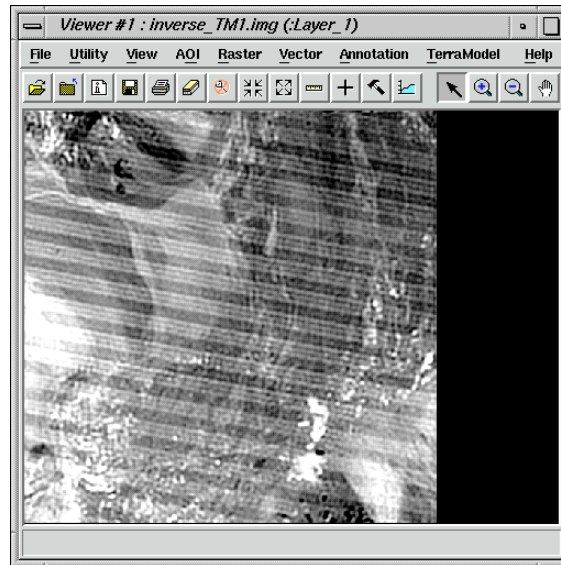

For the other edits performed in this tour guide, you can save the .fft layer and perform an inverse Fourier transform at any time. The steps for doing so are not repeated here. However, the result is shown so that you can see how each edit affects the image.

### Apply Other Filters

1. In the Fourier Editor, click the Open icon on the tool bar, or select **File | Open** from the menu bar.



2. In the Open FFT Layer dialog under **FFT Layer**, enter the name of the first .fft layer you displayed (e.g., **TM\_1.fft**).
3. Click **OK** to display the selected file in the Fourier Editor.
4. When the file displays, select **Mask | Filters** from the Fourier Editor menu bar.
5. In the Low/High Pass Filter dialog, click on the **Window Function** popup list and select **Butterworth**.

This is a smoother function than the Ideal. Use a radius of 80.00, just as with the Ideal.

6. Change the **Radius** to **80.00**.
7. Click **OK** in the Low/High Pass Filter dialog.

The .fft layer and the resulting image are shown in the following picture:



## Fourier Transform Editor

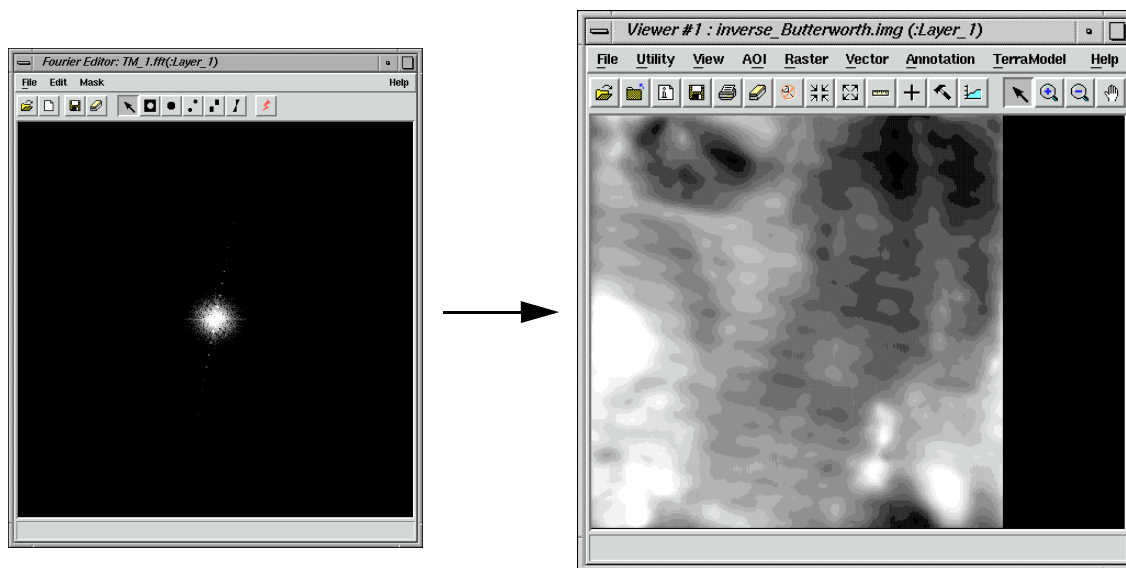

This filter eliminated much of the image content because the radius was too small.

8. Try this same exercise using a **Radius** of **300.00**, rather than **80.00**

The resulting image looks like the following example:

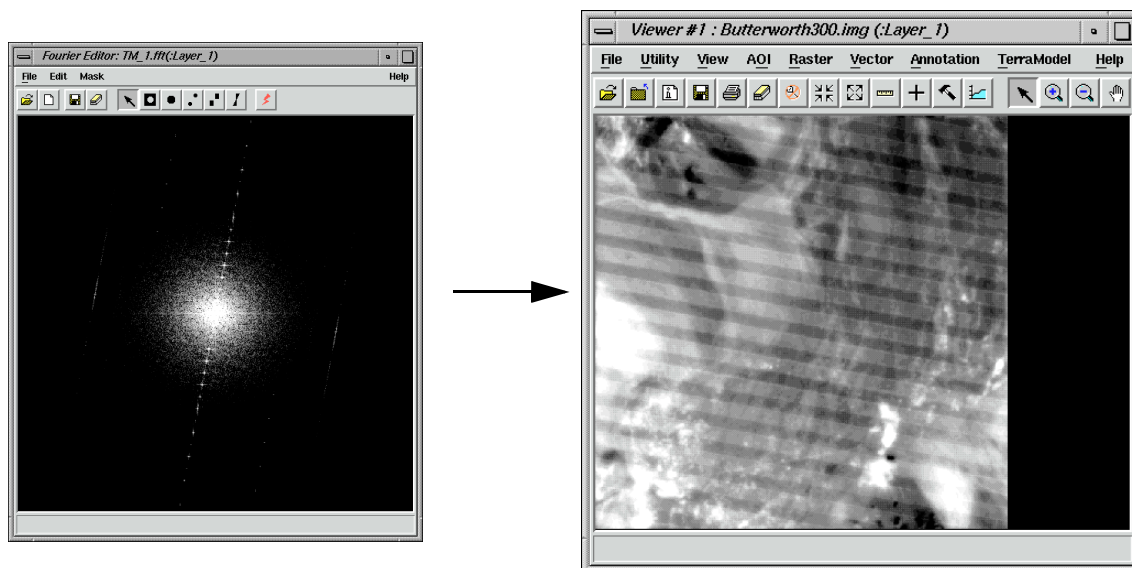

The image is visibly smoothed (perhaps too much). However, the striping remains. You remove the stripes using the wedge filter later in this tour guide. You could try using the Butterworth filter with an even larger radius or the other windows.

The following graphics illustrate some of these other scenarios.

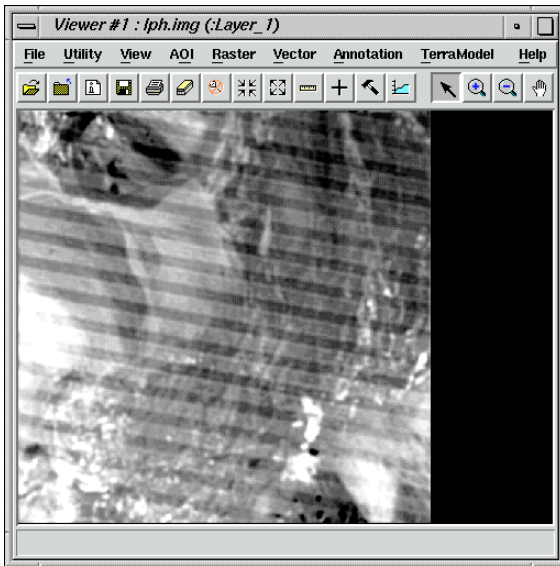

Type: Low Pass  
Window: Hanning  
Radius: 100.00

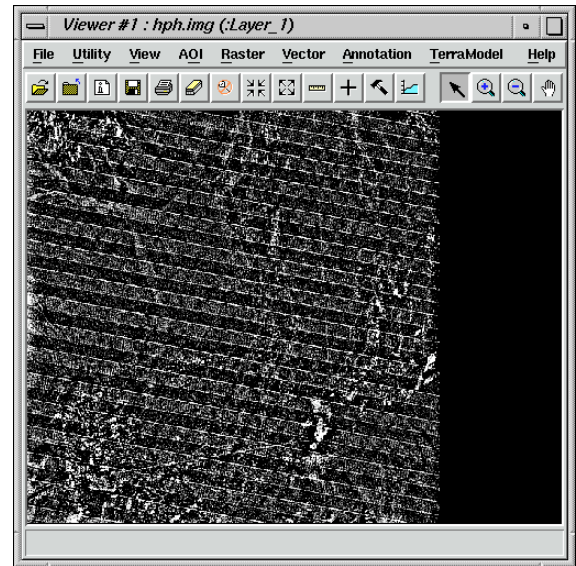

Type: High Pass  
Window: Hanning  
Radius: 20.00

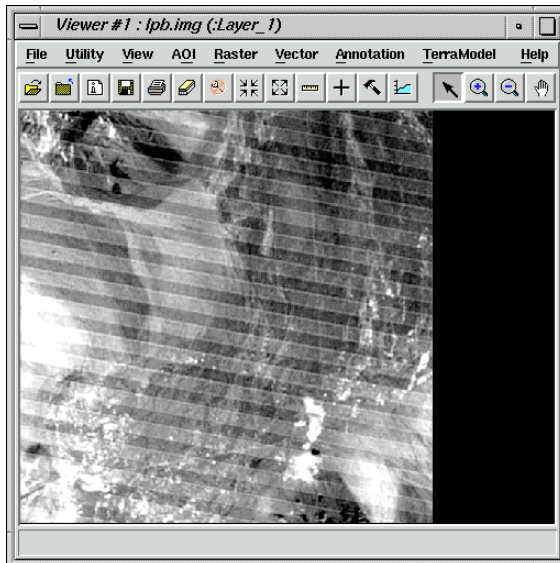

Type: Low Pass  
Window: Bartlett  
Radius: 150.00

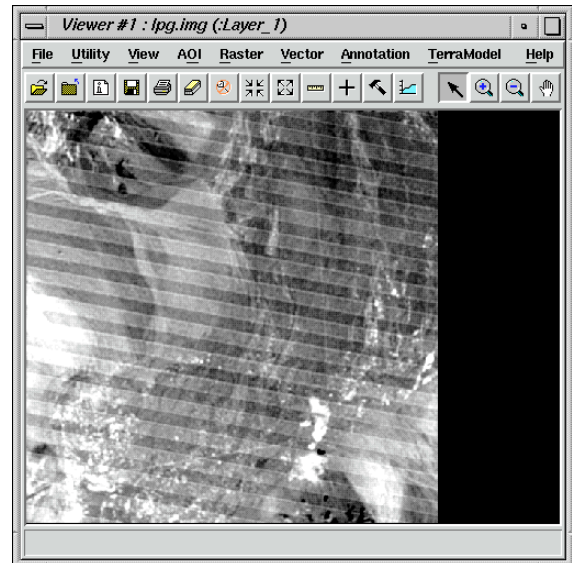

Type: Low Pass  
Window: Gaussian  
Radius: 200.00

9. Redisplay the original .fft layer in the Fourier Editor.

## Use a Circular Mask

There are several bright spots in the .fft layer, such as those in the upper left quadrant. These can be eliminated using the circular mask option.

## Fourier Transform Editor

1. With your cursor in the Fourier Editor, click in the center of one of these bright areas. There is one at  $(u,v) = (-58,-199)$ . You use this coordinate here, but you can use another if you like.
2. When you have selected a coordinate, select **Mask | Circular Mask** from the Fourier Editor menu bar.

The Circular Mask dialog opens.

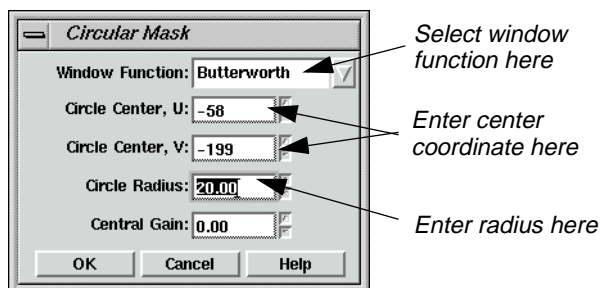

This option is the same as if you were to click on the Circular Mask icon on the tool bar.



3. In the Circular Mask dialog, click on the **Window Function** popup list and select **Butterworth**.
4. Enter **-58** for the **Circle Center, U** and **-199** for the **Circle Center, V**.
5. Enter a **Circle Radius** of **20**.
6. Click **OK** in the Circular Mask dialog to edit the .fft layer.

The bright spot disappears. This edit does not affect the appearance of this particular image very much, since it is such a small area and because the edited area is quite far from the center of the image where most of the image content is contained. However, this technique can be used to remove spikes caused by errant detectors and other types of periodic noise that are manifested by concentrated areas of high or low frequency in the .fft layer.

As an experiment, you create two circles of low frequency to see how they affect the image.

7. In the Fourier Editor, select **Mask | Circular Mask**.
8. In the Circular Mask dialog, enter a **Circle Center, U** of **44** and a **Circle Center, V** of **57**.
9. Enter a **Circle Radius** of **20.00** and a **Central Gain** of **10.00**.
10. Click **OK** in the Circular Mask dialog.

The .fft layer and resulting image look like the following example:

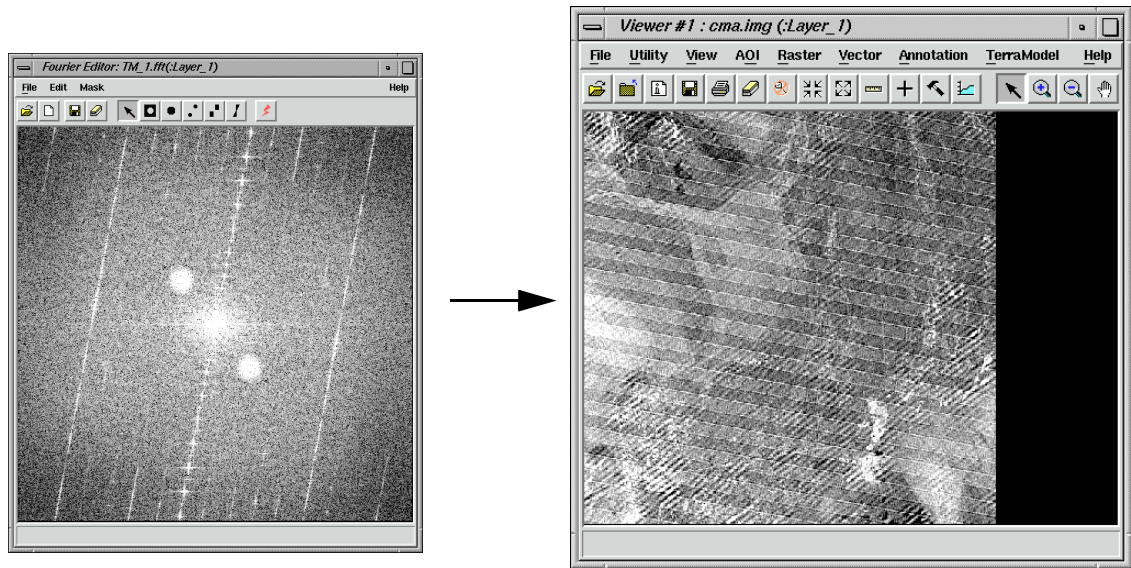

The resulting image has a pronounced diagonal striping, in addition to the original striping.

*NOTE: Remember to select another circle center coordinate before trying each new window.*

## Use a Rectangular Mask

The rectangular mask allows you to mask a rectangular area of the .fft layer. This is similar to the circular mask in that it allows you to edit non-central regions of the Fourier image.

1. Make sure the .fft file you created in the previous section, “Use a Circular Mask”, is displayed in the Fourier Editor.
2. In the Fourier Editor menu bar, select **Mask | Rectangular Mask**.

The Rectangular Mask dialog opens.

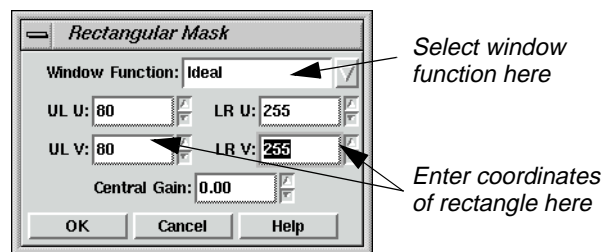

3. In the Rectangular Mask dialog, click on the **Window Function** popup list and select **Ideal**.
4. Enter an upper left  $u$  (**UL U**) of **80** and an upper left  $v$  (**UL V**) of **80**.
5. Enter a lower right  $u$  (**LR U**) of **255** and a lower right  $v$  (**LR V**) of **255**.
6. Click **OK** in the Rectangular Mask dialog.



## Fourier Transform Editor

The top left and bottom right corners of the .fft layer are black. To mask the other two corners, you must repeat this procedure.

7. Select **Mask | Rectangular Mask**.
8. In the Rectangular Mask dialog, click on the **Window Function** popup list and select **Ideal**.
9. Enter an upper left  $u$  (**UL U**) of **80** and an upper left  $v$  (**UL V**) of **-255**.
10. Enter a lower right  $u$  (**LR U**) of **255** and a lower right  $v$  (**LR V**) of **-80**.
11. Click **OK** in the Rectangular Mask dialog.

The top, right and bottom, left corners of the .fft layer are now black also, making the .fft layer look like a cross.

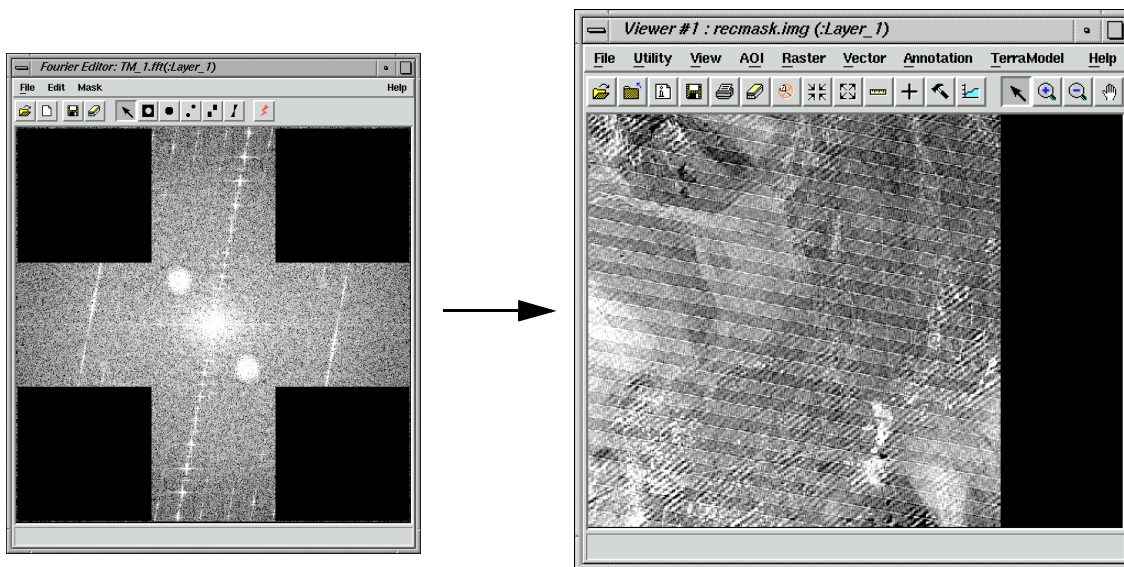

The resulting image is visibly smoother than the original.

### Use a Wedge Mask

The wedge mask option is often used to remove striping in imagery that appears in the .fft layer as radial lines. Most of the striping in the Landsat image you are using is manifested in the .fft layer as the bright, nearly vertical line that passes through the origin.

1. If it is not already displayed, open the original .fft layer in the Fourier Editor (i.e., **TM\_1.fft**).
2. With your cursor in the Fourier Editor, click in the center of one of the bright areas that make up the line. You need to enter this information in the dialog. For this example, you use (35, -186).
3. Select **Mask | Wedge Mask**.

The Wedge Mask dialog opens.

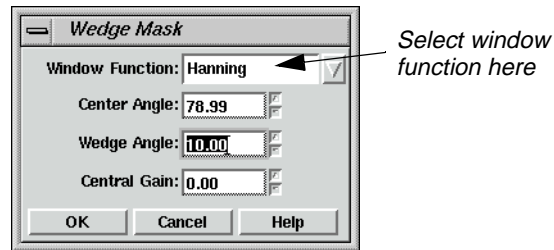

- In the Wedge Mask dialog for the **Center Angle**, enter the following expression to calculate the center of the wedge, based on the coordinate that you selected.

**$-\text{atan}(-185/36)$**

- Press Return on your keyboard. The value returned is **78.99**.

### Wedge Mask Angles

The angles are measured as shown in the illustration below.

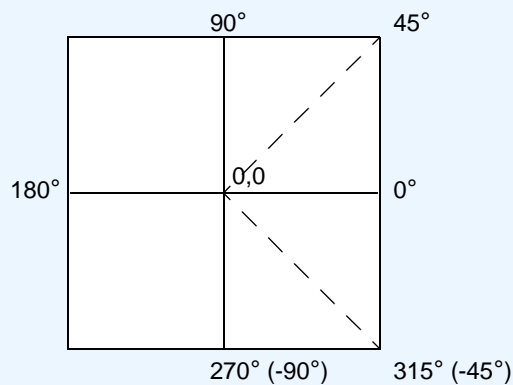

- Enter a **Wedge Angle** of **10.00**.

This is the total angle of the wedge, in this case, 5.00 degrees on either side of the center.

- Click **OK** to edit the layer.

The resulting .fft layer looks similar to the following example:



# Fourier Transform Editor

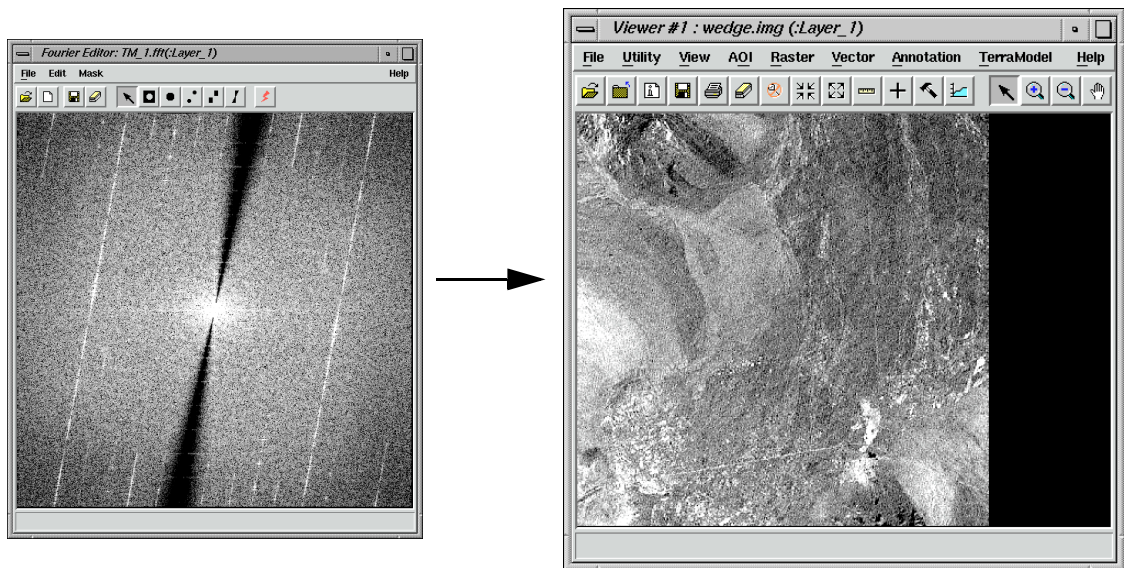

After performing an inverse Fourier transform, the resulting image is destriped.

## Edit Using Mouse-Driven Tools

The mouse-driven tools allow you to perform the same types of edits as in the menu options, but they are a bit easier to use since they are more interactive than the dialogs. You can extend a filter radius or indicate where to place a mask simply by dragging the mouse.

1. If it is not already displayed, open the original .fft layer in the Fourier Editor (e.g., **TM\_1.fft**).
2. From the Fourier Editor menu bar, select **Edit | Filter Options**.

The Filter Options dialog opens.

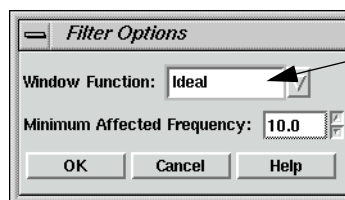

Select window function here

This is where you set the window that is used for all subsequent mouse-driven editing options. However, you can change this window at any time. The **Minimum Affected Frequency** option allows you to enter the minimum frequency value that is affected by the filter. Setting this value to a number less than 10.00 might eliminate very low frequency data that are crucial to the content of the image.

3. In the Filter Options dialog, click on the **Window Function** popup list and select **Ideal**.
4. Click **OK**.



**Use Low-Pass Filtering**      The first tool you use is the Low-Pass Filter tool.

1. Click the Low-Pass Filter icon on the Fourier Editor tool bar.



2. With your cursor in the center of the Fourier Editor, drag toward the right until the  $u$  coordinate in the status bar reads **80**. Then release the mouse.

The image is filtered as soon as the mouse is released. This is equivalent to the second filtering operation you performed using the menu bar tools.

You can select **Edit | Undo** at any time to undo an edit. Select **File | Revert** to undo a series of edits. The Low-Pass Filter tool remains active until you either select another tool or click the Select tool.

**Use High-Pass Filtering**      Next, you use the High-Pass Filter tool.

1. Select **Edit | Filter Options** from the Fourier Editor menu bar.
2. In the Filter Options dialog, click on the **Window Function** popup list and select **Hanning**.
3. Click **OK** in the Filter Options dialog.
4. Click the High-Pass Filter icon on the tool bar.



5. With your cursor in the center of the Fourier Editor, drag toward the right until the  $u$  coordinate in the status bar reads **20**. Release the mouse button.

The image is filtered as soon as the mouse is released. The combination of filters is shown in the following example:



## Fourier Transform Editor

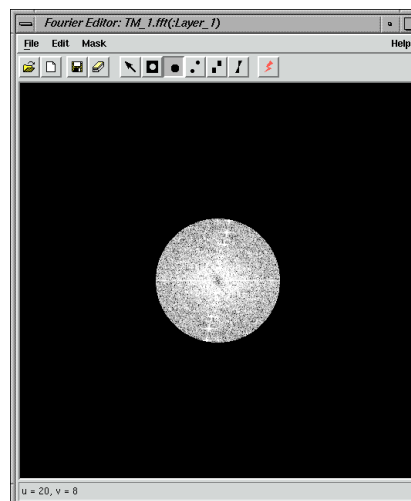

6. Select **File | Save As** from the menu bar.  
The Save Layer As dialog opens.
7. In the Save Layer As dialog, enter a new name for the .fft layer, such as **TM1highpass.fft**. Be sure to use a directory in which you have write permission.
8. Click **OK** to save the layer.
9. Click the Run icon on the tool bar or select **File | Inverse Transform** from the menu bar to create an inverse Fourier layer for display.



10. In the Inverse Fourier Transform dialog, enter a name for the new .img layer in the directory of your choice, such as **TM1highpass.img**.
11. Click **OK**.  
A Job Status dialog displays, indicating the progress of the function.
12. When the Job Status dialog indicates that the new .img layer is created, click **OK** and then display the layer in a Viewer.

Your new image should look similar to the following example:

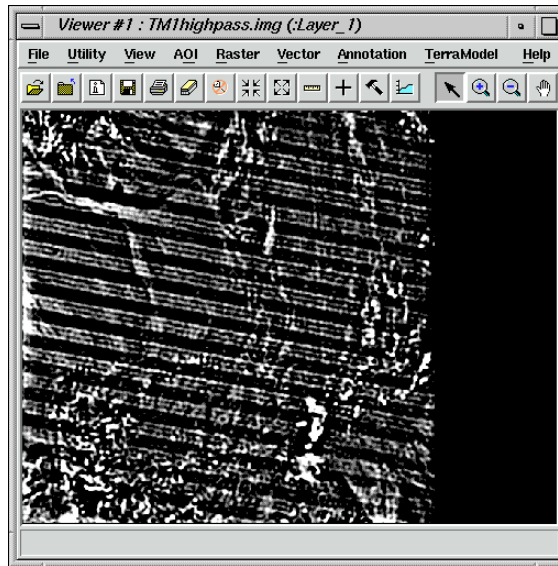

### Apply a Wedge Mask

In the next exercise, you remove the nearly vertical radial line in the image, thereby removing the striping in the original image.

1. Redisplay the original .fft layer in the Fourier Editor if you have not already done so.
2. The Hanning window is still selected from the previous section, so you do not change it.
3. Click the Wedge Mask icon on the tool bar.



4. Using the following example as a guide, with your cursor over the center of the line, drag to the right until the lines of the wedge are about 20 degrees apart. Release the mouse button.



# Fourier Transform Editor

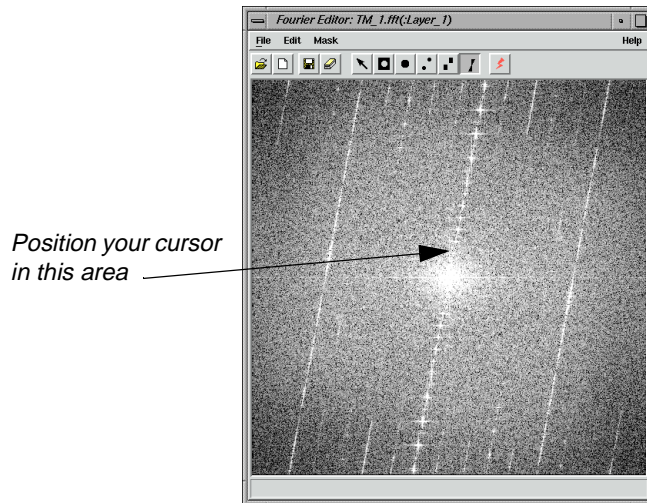

The image is filtered as soon as you release the mouse, and similar to the following example. The resulting image is also shown.

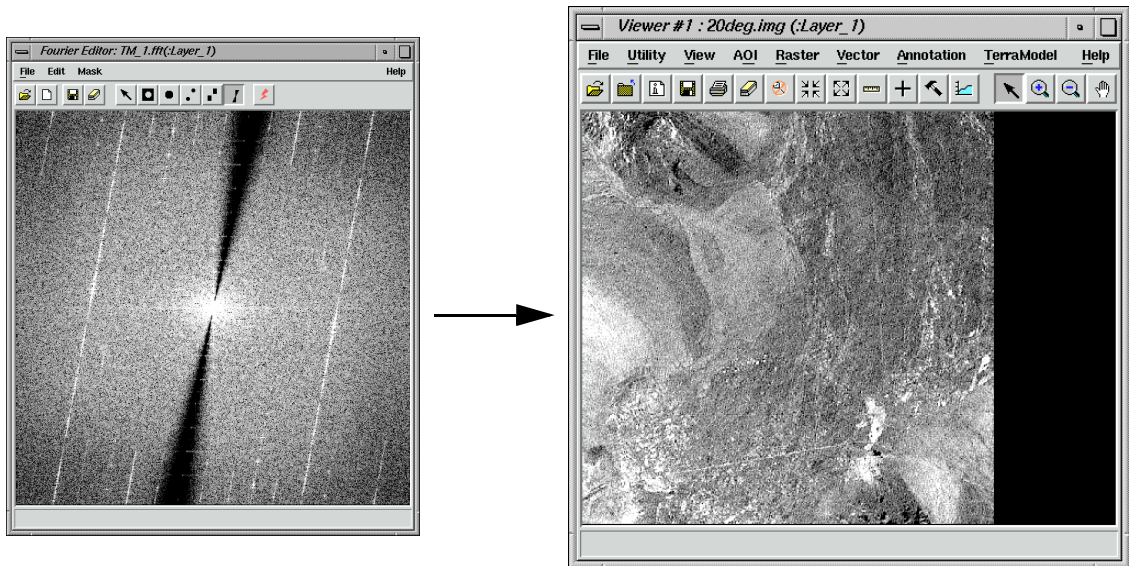

## Combine Edits

You may combine as many edits as you like during an editing session. Since the Fourier Transform and Inverse Fourier Transform are linear operations, the effect of each edit on the resulting image is independent of the others. Here, you perform a low-pass filter over the wedged .fft layer that you just created.

1. With the .fft layer that you just created displayed in the Fourier Editor, click the Low-Pass Filter tool.



2. With your cursor in the center of the Fourier Editor, drag toward the right until the  $u$  coordinate in the status bar is about **200**.

The .fft layer and resulting image look similar to the following:

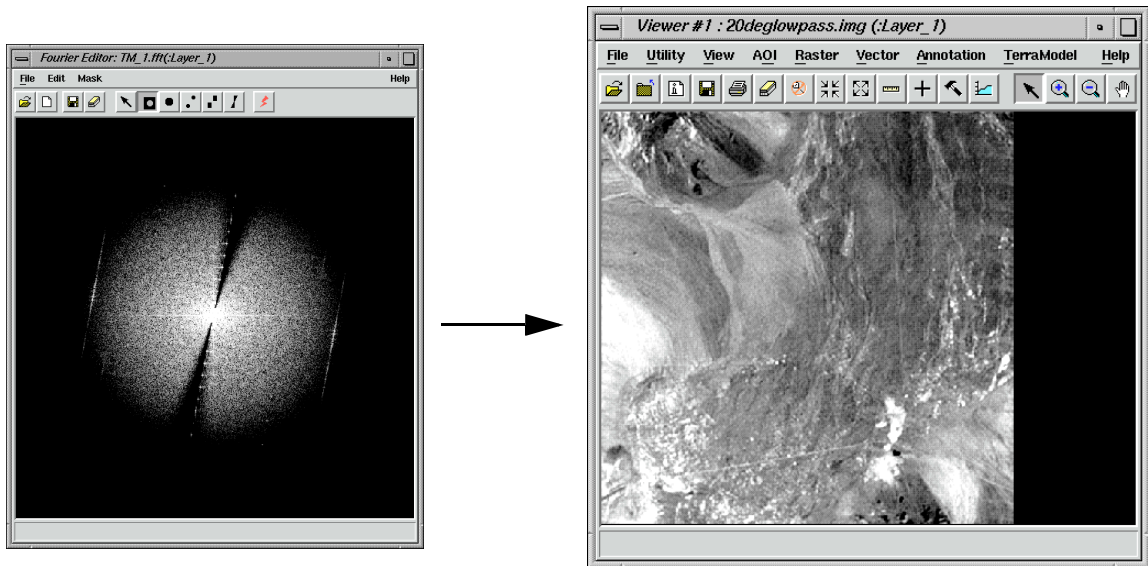

For more information about the Fourier Transform Editor, see "APPENDIX A: Additional Information" on page 595.



# Fourier Transform Editor



# CHAPTER 11

## Image Interpreter

---

### Introduction

Image Interpreter is a group of over 50 functions that can be applied at the touch of a button to images with parameters you input. Most of the Image Interpreter functions are algorithms constructed as graphical models with Model Maker. These algorithms are common enhancements and utilities that have been made easily accessible through the Image Interpreter.

*NOTE: Some of these functions are found in other parts of ERDAS IMAGINE, but are also listed in Image Interpreter for convenience.*

The models used in Image Interpreter functions can be edited and adapted as needed with Model Maker (from Spatial Modeler) or the Spatial Modeler Language.



*See the Spatial Modeler section of this manual for a description of the relationship between Spatial Modeler Language, Model Maker, and Image Interpreter. See "CHAPTER 11: Geographic Information Systems" of the ERDAS Field Guide for more information on modeling.*



*Approximate completion time for this tour guide is 50 minutes.*

---

### Subsetting an Image

Many images used in IMAGINE cover a large area, while the actual area being studied can only cover a small portion of the image. To save on disk space and processing time, IMAGINE will let you make new images out of a subset of the entire dataset.

In this exercise, you will use the Subset Utility to take a subset of a small urbanized Area of Interest (AOI) from a much larger Landsat scene of San Diego.

#### Prepare

ERDAS IMAGINE should be running with a Viewer open.

1. Select **File | Open Raster Layer** from the Viewer menu bar.

The Select Layer to add dialog opens.



# Image Interpreter

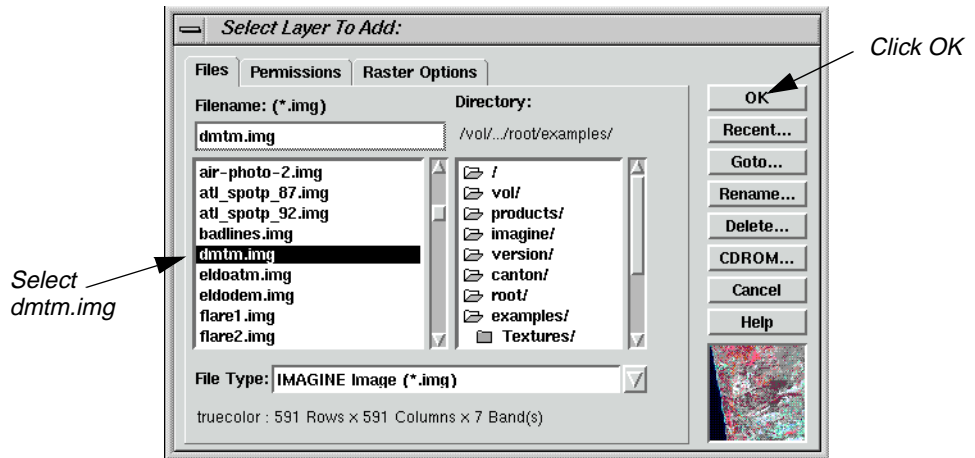

2. Select `dmtm.img` from the list of examples.
3. Click on **OK** to have the image display in the Viewer.

## Selecting an AOI to Subset

In this section, you use the Subset utility to take a small Subset from a large image without using the Snap to Raster option.

1. With the cursor in the Viewer, right-click to access the Quick-View menu.
2. Select **Inquire Box...** from the Quick-View menu. The Inquire Box dialog displays. The title of this dialog is **Viewer #1: dmtm.img**.

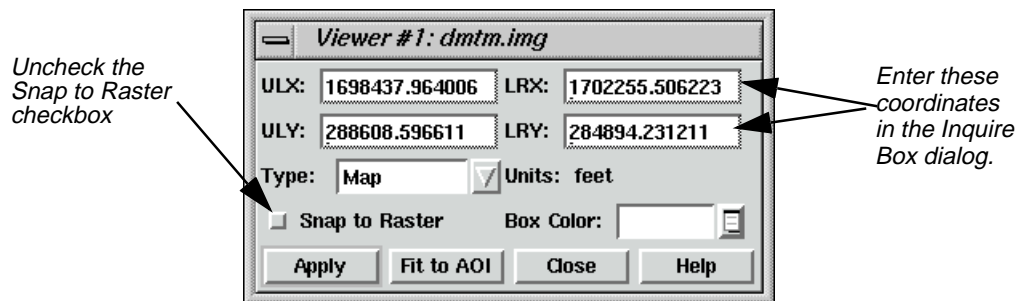

3. Click on the Snap to Raster checkbox to uncheck this option. This will tell the Subset function to use the exact coordinates you enter for the Inquire Box.
4. Enter the following coordinates into the Inquire Box dialog:

ULX: **1698385.570**  
ULY: **288632.691217**  
LRX: **1702282.557434**  
LRY: **284900.708704**



## Subsetting an Image

5. Click **Apply** on the Inquire Box dialog. The Inquire Box moves to the new coordinates.

6. Use the **Zoom Tool**  to zoom in on the Area of Interest.

The image in your Viewer should look something like this:

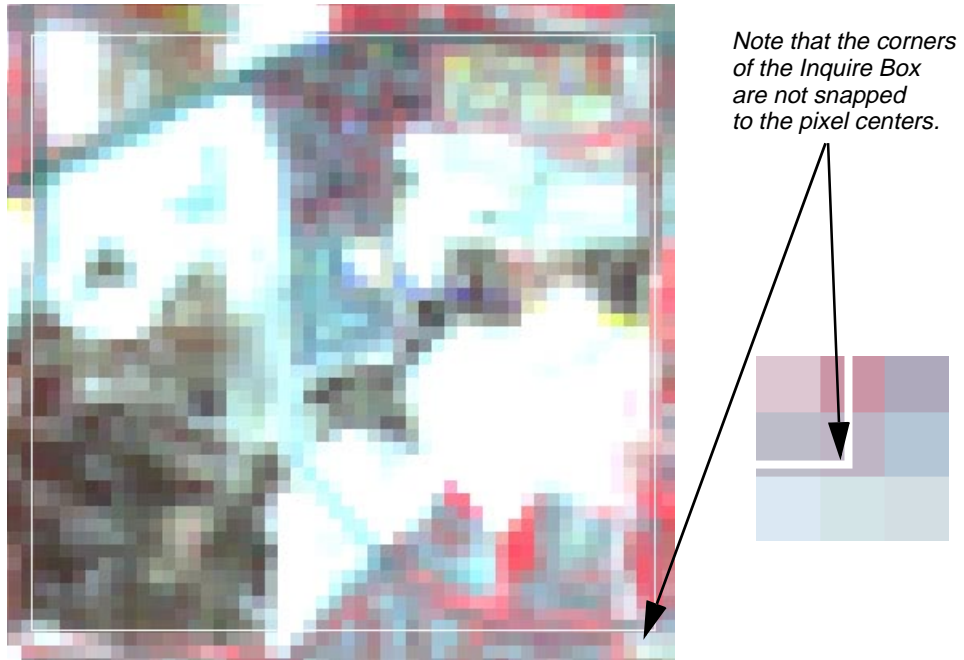

### Subsetting an Image Without Snapping

1. Click on the Interpreter icon in the ERDAS IMAGINE icon panel.



The **Image Interpreter** menu opens. Each of the buttons in the **Image Interpreter** menu displays a submenu of Image Interpreter functions



# Image Interpreter

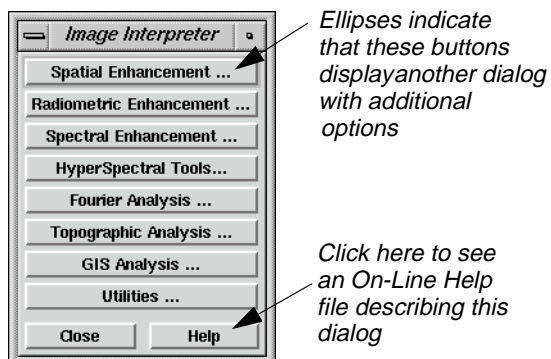

2. Select **Utilities** from the **Image Interpreter** menu and the **Utilities** menu opens

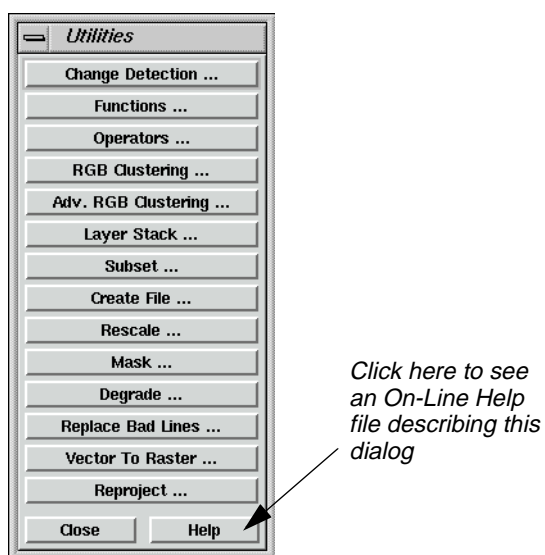

3. Select **Subset** from the **Utilities** menu and the Subset dialog opens.

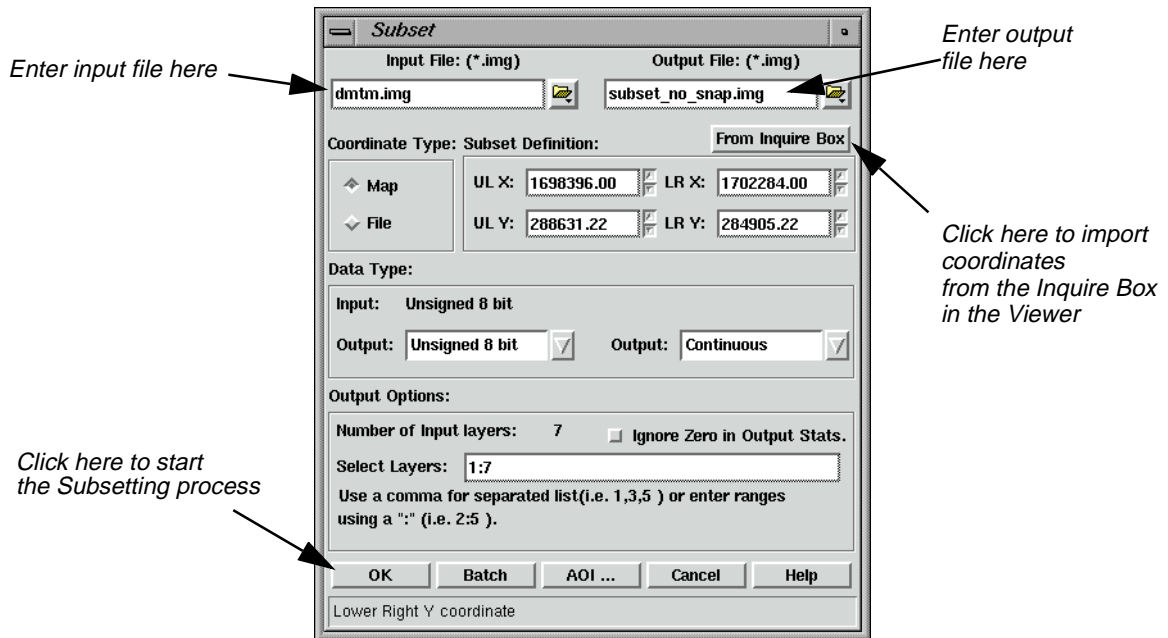

4. Under **Input File** in the Subset dialog, enter **dmtm.img**.

This is a Landsat TM image of San Diego, California.

5. Under **Output File**, enter **subset\_no\_snap.img** in a directory where you have write permission.
6. Click **OK** to begin the Subsetting process.

A Job Status bar displays, indicating the progress of the subsetting operation.

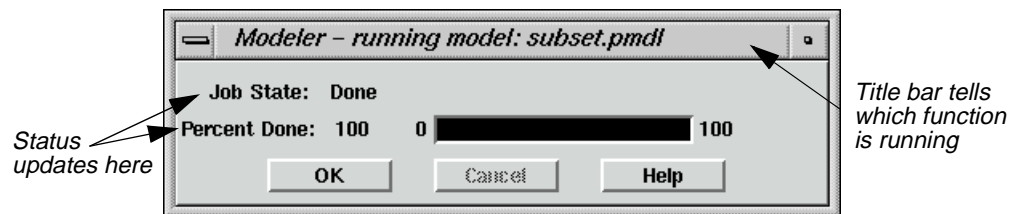

7. Depending on your **eml Preferences** (under **Session | Preferences | User Interface & Session | Keep Job Status Box**), when the Job Status bar shows 100, indicating that the job is 100% done, you must either click **OK** to close the dialog or the dialog closes automatically.

### Displaying the Subset with the Original Data

1. The original image should still be displayed in the Viewer.
2. Select **File | Open** from the menu bar on the Viewer.



# Image Interpreter

The Select Layer to Add dialog displays.

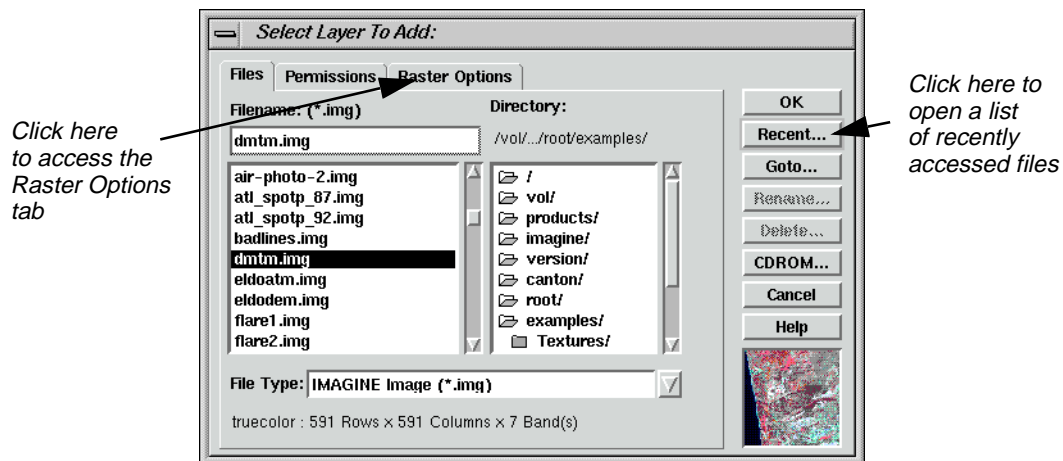

3. Click the Recent button to open a list of recently accessed files.
4. Select **subset\_no\_snap.img** from the List of Recent Files.
5. Click **OK** to dismiss the List of Recent Files.
6. Click the Raster Options tab

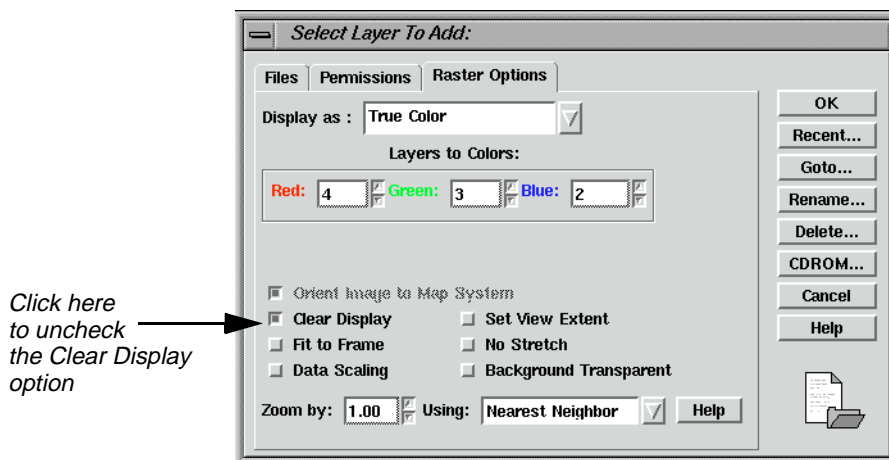

7. Uncheck the **Clear Display** option so the new subset of the original image will appear superimposed on the original image.
8. Click OK.

The subset displays in the Viewer over the original image.

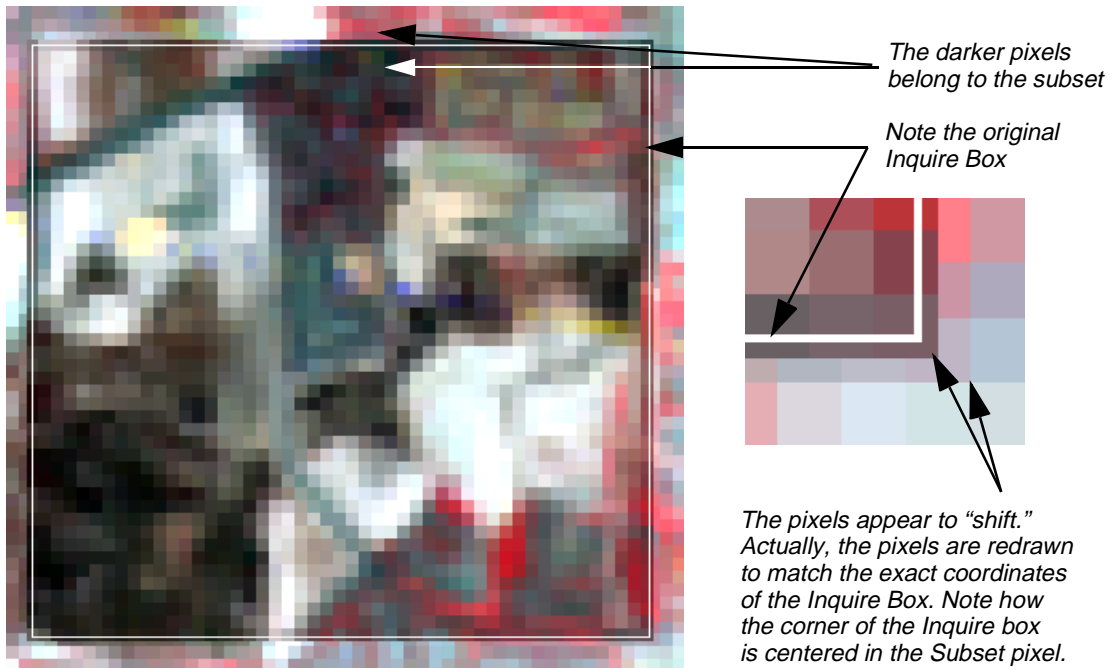

When a subset of an image is taken from an inquire box that is not snapped to the pixel grid of the original image

9. Click on the Clear Top Layer icon  to remove **subset\_no\_snap.img** from the Viewer.

The original image and the Inquire Box should still be displayed in the Viewer.

### Subsetting an Image With Snap to Raster

1. In the Inquire Box dialog, click the **Snap to Raster** checkbox to make sure it is active (checked). Click **Apply**.



## Image Interpreter

The Inquire Box snaps to the pixels centers and looks like this:

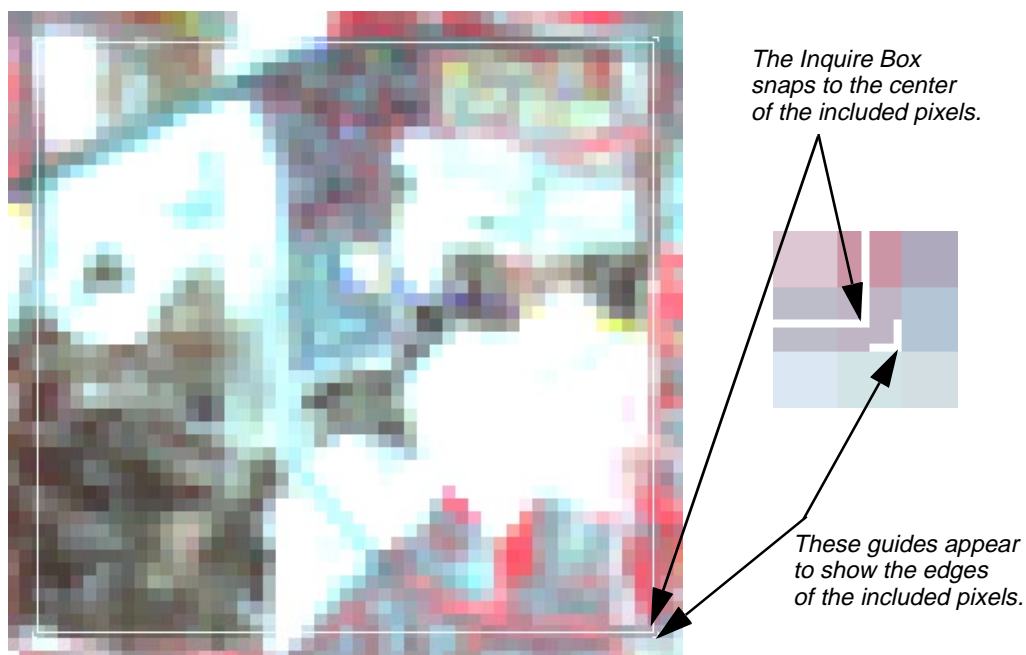

The coordinates in the Inquire Box dialog update to reflect the new corner coordinates.

2. In the Utilities dialog, click on the **Subset** button. The Subset dialog displays.
3. Under **Input File**, enter **dmtm.img**.
4. In the **Output File**, enter **subset\_snap.img** in a directory where you have write permission.
5. Click the **From Inquire Box** button.

The coordinates in the **Subset Definition** area update to reflect the corner coordinates of the Inquire Box.

6. Click **OK** to start the Subsetting Process.

The Subsetting Progress meter appears, displaying the progress of the subsetting.

### Viewing the Snapped Subset

1. Select **File | Open** from the menu bar in the Viewer.

The **Select Layer to Add** dialog opens.

2. Click on the Recent button.

The **List of Recent Files** dialog displays.

3. Select **subset\_snap.img** from the list.

## Apply Spatial Enhancement

4. Click **OK** on the List of Recent Files to close the dialog.
5. Click on the **Raster Options** tab in the Select Layer to Add dialog.
6. Deselect the **Clear Display** option.
7. Click **OK** to open **subset\_snap.img** in the Viewer on top of dmtm.img.

The subsetted image displays in the Viewer.

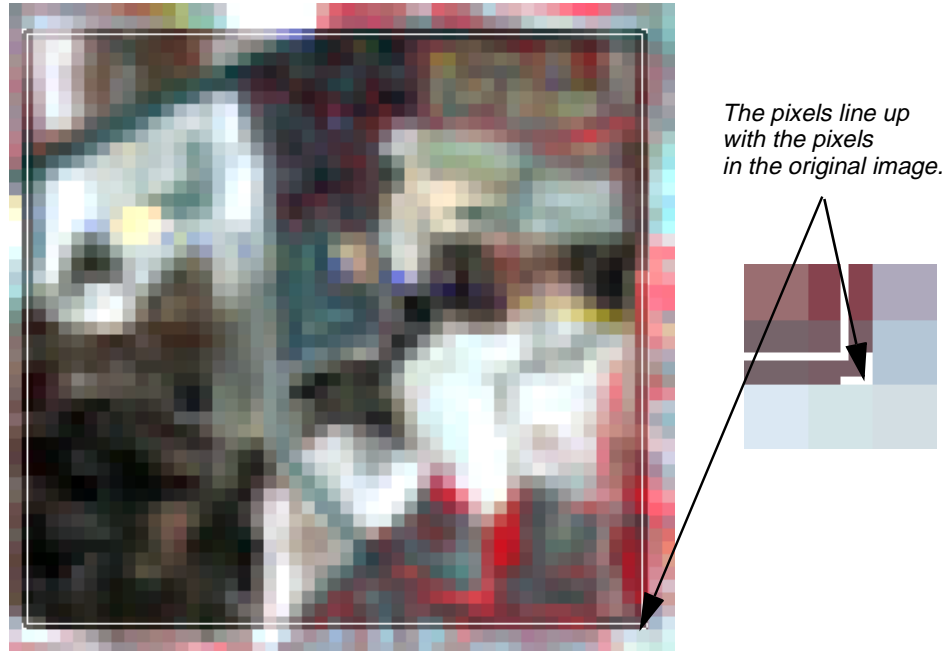

Because the Inquire Box was snapped to the centers of the pixels before the image was processed, the pixels in the output file will line up exactly with the pixels in the original image.

8. Click **Close** on the Viewer.
9. Click **Close** on the Utilities menu.

---

### Apply Spatial Enhancement

#### Prepare

ERDAS IMAGINE should be running with a Viewer open.

In this section, you use the convolution and crisp Spatial Enhancement functions to enhance images.

1. Click on the Interpreter icon in the ERDAS IMAGINE icon panel.



# Image Interpreter



The **Image Interpreter** menu opens.

2. Select **Spatial Enhancement** from the **Image Interpreter** menu and the **Spatial Enhancement** menu opens.

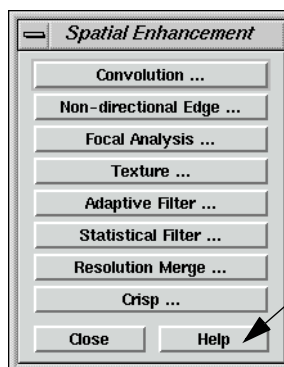

*Click here to see an On-Line Help file describing this dialog*

## Apply Convolution

1. Select **Convolution** from the **Spatial Enhancement** menu and the Convolution dialog opens.



## Apply Spatial Enhancement

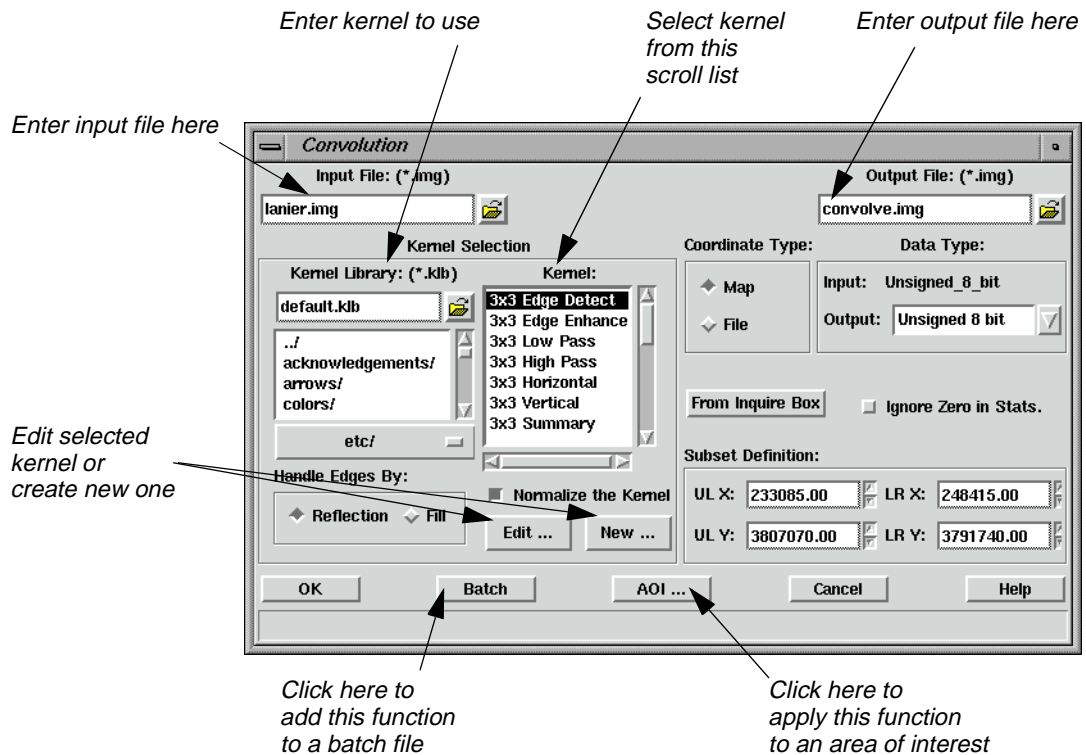

This interactive Convolution tool lets you perform convolution filtering on images. It provides a scrolling list of standard filters and lets you create new kernels. The new kernels can be saved to a library and used again at a later time.

*NOTE: Do not close the **Image Interpreter** menu, as you continue using it in the next section.*

### Select Input/Output Files

1. In the Convolution dialog, under **Input File**, enter **lanier.img**.
2. Under **Output File**, enter **convolve.img** in the directory of your choice. It is not necessary to add the .img extension when typing the file name—ERDAS IMAGINE automatically appends the correct extension.

*NOTE: Make sure you remember in which directory the output file is saved. This is important when you try to display the output file in a Viewer.*

### Select Kernel

Next, you must select the kernel to use for the convolution. A default kernel library containing some of the most common convolution filters is supplied with ERDAS IMAGINE. This library is opened in the **Kernel Selection** part of this dialog.

1. From the scrolling list under **Kernel**, click on **3x3 Edge Detect**.
2. Click on the **Edit** button in the **Kernel Selection** box.

The 3 × 3 Edge Detect dialog opens.



# Image Interpreter

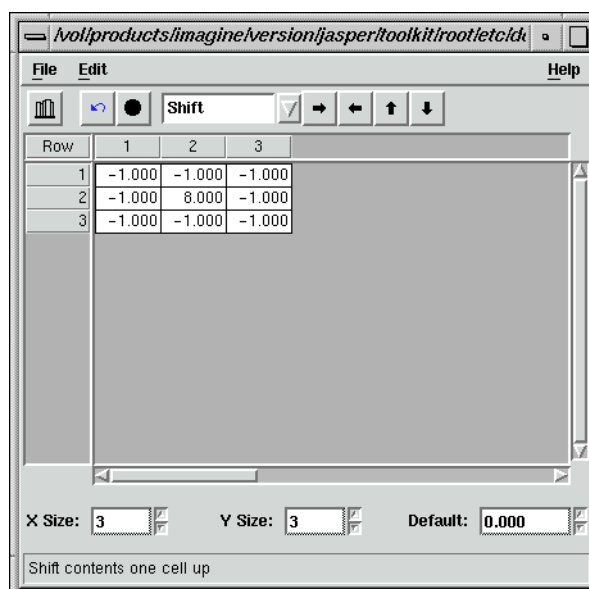

For this exercise, you use the Kernel Editor to simply view the kernel used for the  $3 \times 3$  Edge Detect filter. However, if desired, you could make changes to the kernel at this time by editing the CellArray.

3. Select **File | Close** from the  $3 \times 3$  Edge Detect dialog.
4. Click **OK** in the Convolution dialog.

A Job Status dialog displays, indicating the progress of the function.

5. When the Job Status dialog shows that the process is 100% complete, click **OK**.

## Check the File

1. Select **File | Open | Raster Layer** from the Viewer menu bar.

The Select Layer To Add dialog opens

2. In the Select Layer To Add dialog under **Filename**, click on **lanier.img**.
3. Click **OK** to display the file in the Viewer.
4. Open a second Viewer window by clicking on the Viewer icon in the ERDAS IMAGINE icon panel.



## Apply Spatial Enhancement

5. Select **File | Open | Raster Layer** from the menu bar of the Viewer you just opened.

The Select Layer To Add dialog opens.

6. In the Select Layer To Add dialog under **Filename**, enter the name of the directory in which you saved **convolve.img**, and press the Return key on your keyboard.
7. In the list of files, click on **convolve.img** and then click **OK**.

The output file generated by the Convolve function, **convolve.img**, displays in the second Viewer.

8. In the ERDAS IMAGINE menu bar, select **Session | Tile Viewers** to compare the two files side by side.

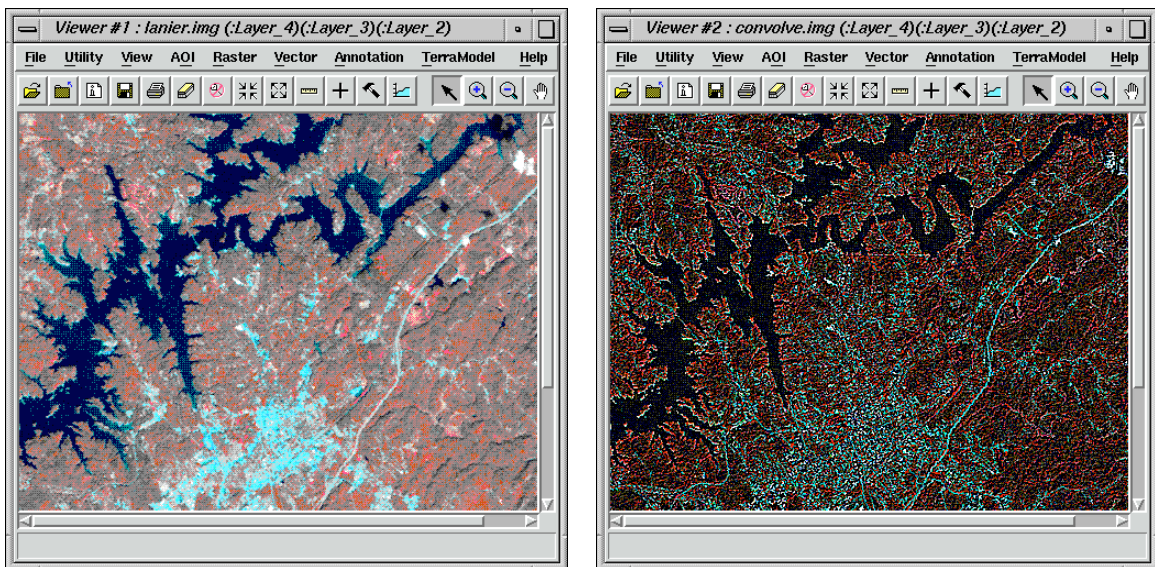

9. When you are finished comparing the two files, select **File | Clear** from the menu bar of each Viewer.

### Apply Crisp

1. Select **Crisp** from the **Spatial Enhancement** menu.

The Crisp dialog opens.



# Image Interpreter

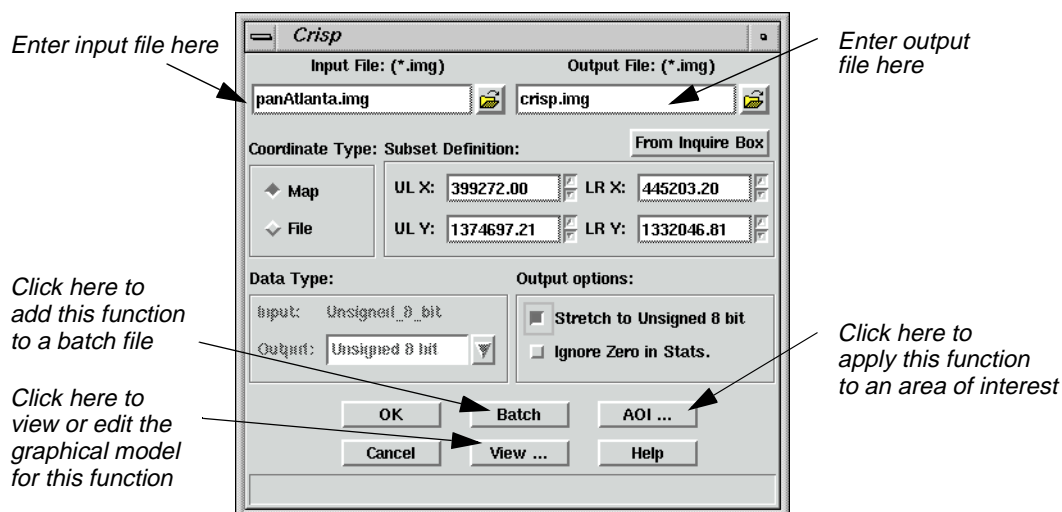

The Crisp dialog is a good example of the basic Image Interpreter dialog. Other dialogs may have more prompts for inputs, depending on the function. Each dialog opens with default entries that are acceptable for use. These entries can be changed, if necessary, to achieve specific results.

2. Under **Input File** in the Crisp dialog, enter **panAtlanta.img**.

This is a SPOT panchromatic scene of downtown Atlanta, Georgia.

3. Under **Output File**, enter **crisp.img** in the directory of your choice as the output file.
4. Under **Output Options** in the Crisp dialog, turn on the **Stretch to Unsigned 8 bit** checkbox by clicking on it.

This option produces the output file in unsigned 8-bit format, which saves disk space.

## Use the View Option

1. Click on the **View** button at the bottom of the Crisp dialog.

The Model Maker viewer window opens and displays the graphical model used for the Crisp function.

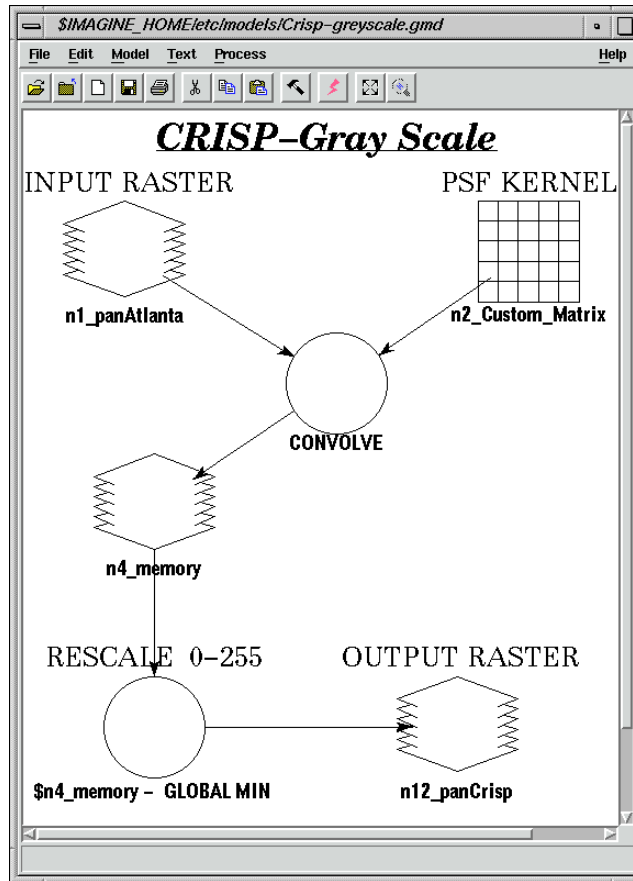

The **View** button in each Image Interpreter dialog lets you view the graphical model behind each function. If you want to change the model for a specific purpose, you can edit it through the Model Maker and apply the edited function to the image by running the model in Model Maker.



See "CHAPTER 16: Spatial Modeler" for information on editing and running a model in Model Maker.

2. Exit the Model Maker by selecting **File | Close All**.
3. Click **OK** in the Crisp dialog to start the process.  
A Job Status dialog opens, indicating the progress of the function.
4. When the Job Status dialog shows that the process is 100% complete, click **OK**.

## View Results

1. Display **panAtlanta.img** in a Viewer.



## Image Interpreter

2. Display **crisp.img**, the output file generated by the Crisp function, in the other Viewer.
3. Note the differences between the two images; **crisp.img** appears to be sharper.

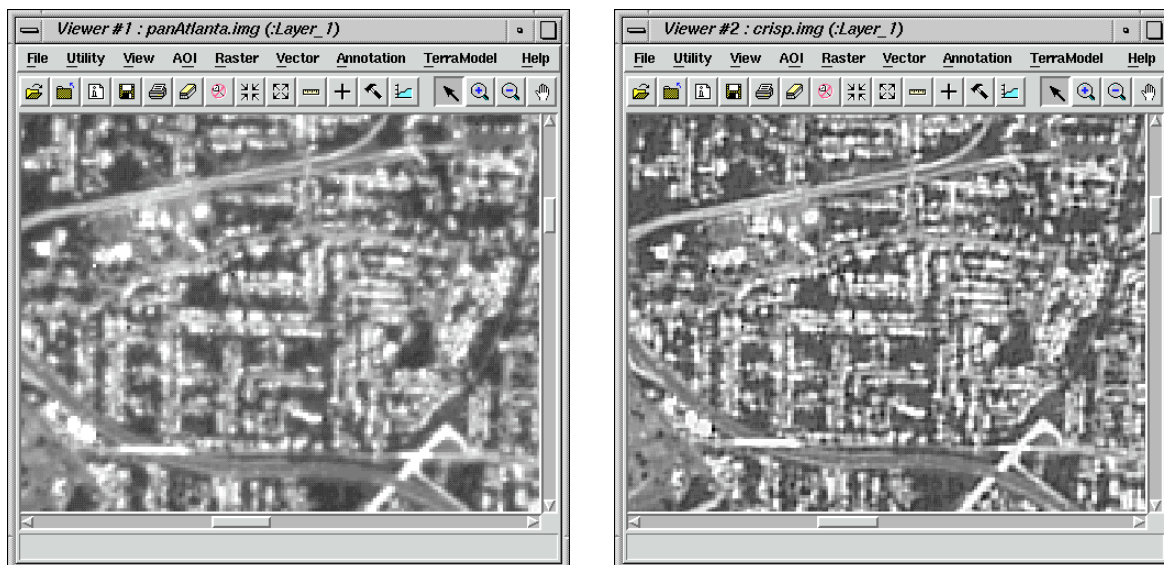

4. Use the Zoom In tool in the Viewer tool bar to zoom in for a closer look at the crispening of the image in **crisp.img**.
5. When you are through, close all the Viewers at once by selecting **Session | Close All Viewers** from the ERDAS IMAGINE menu bar.
6. Click **Close** in the **Spatial Enhancement** menu.

*NOTE: Do not close the **Image Interpreter** menu, as you continue using it in the next section.*

---

## Apply Radiometric Enhancement

1. In the **Image Interpreter** menu, select **Radiometric Enhancement**.  
The **Radiometric Enhance** menu opens.

## Apply Radiometric Enhancement

Click here to access the Brightness Inversion function

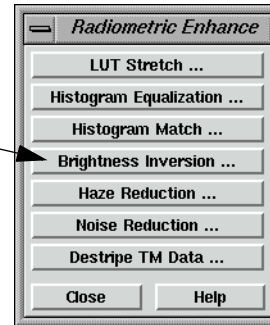

In this section, you use both the **Inverse** and **Reverse** options of the **Image Inversion** function to enhance images. Inverse emphasizes detail in the dark portions of an image. Reverse simply reverses the DN values.

### Apply Brightness Inversion

1. In the **Radiometric Enhance** menu, select **Brightness Inversion**.

The Brightness Inversion dialog opens.

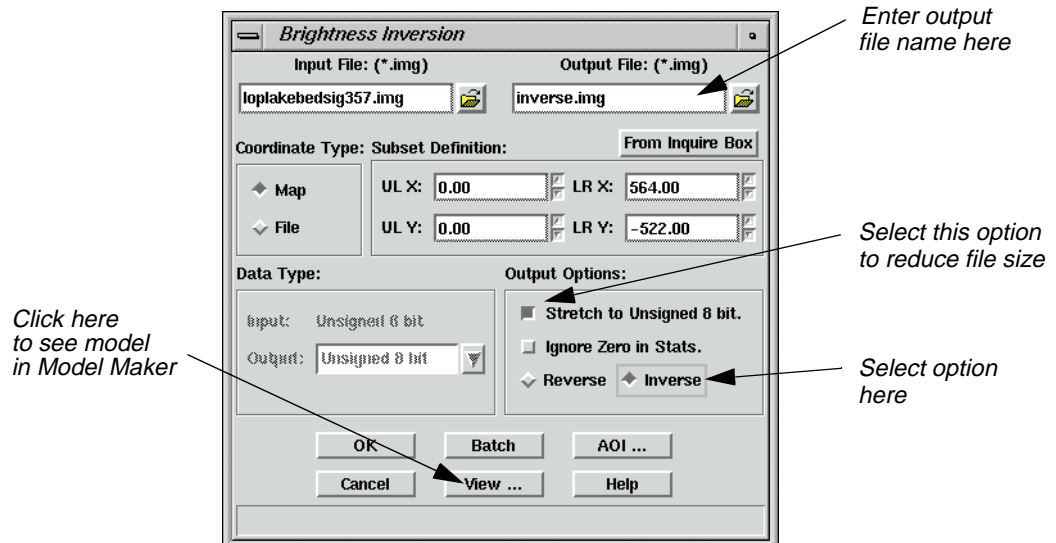

2. In the Brightness Inversion dialog under **Input File**, enter **loplakebedsig357.img**.
3. Under **Output File**, enter **inverse.img** in the directory of your choice.
4. Under **Output Options**, turn on the **Stretch to Unsigned 8 bit** checkbox by clicking on it.
5. Under **Output Options**, click on **Inverse**.



## Image Interpreter

6. Click **OK** in the Brightness Inversion dialog to start the process.

A Job Status dialog displays, indicating the progress of the function.

### Reverse

1. Select **Brightness Inversion** from the **Radiometric Enhance** menu.

The Brightness Inversion dialog opens.

2. In the Brightness Inversion dialog, enter **loplakebedsig357.img** as the input file.
3. Enter **reverse.img** in the directory of your choice as the **Output File**.
4. Turn on the **Stretch to Unsigned 8 bit** checkbox under **Output Options**.
5. Click **OK** in the Brightness Inversion dialog to start the process.

A Job Status dialog displays, indicating the progress of the function.

### View Changes

1. Open a Viewer and display **inverse.img**.
2. Right-hold within the Viewer and select **Fit Window to Image** from the **Quick View** menu.  
The Viewer changes size to bound the image data.
3. Select **View | Split | Split Vertical** from the Viewer menu bar.  
A second Viewer opens.
4. In the second Viewer, click on the Open icon (this is the same as selecting **File | Open | Raster Layer** from the Viewer menu bar).



The Select Layer To Add dialog opens.

5. From the Select Layer To Add dialog, open the file **reverse.img**.
6. In the second Viewer, select **View | Split | Split Vertical** from the Viewer menu bar.  
A third Viewer opens.
7. With your cursor in Viewer #3, press **Ctrl-r** on your keyboard (this is just another way to open a raster layer).

The Select Layer To Add dialog opens.

8. From the Select Layer To Add dialog, open the file **loplakebedsig357.img**.



## Apply Radiometric Enhancement

9. Resize the Viewers on screen so that you can see all three Viewers. Note the differences between **inverse.img** and **reverse.img** compared to the original file.

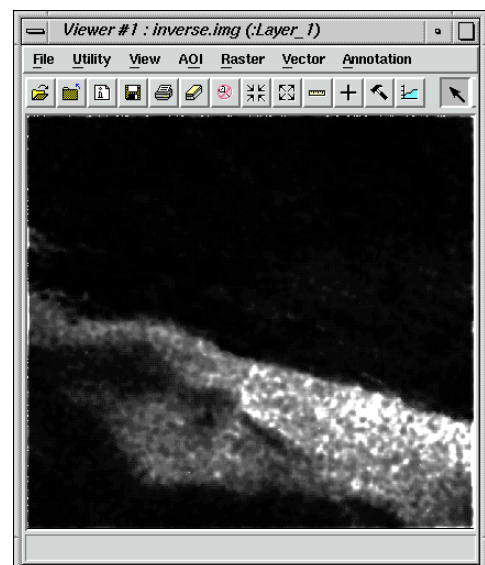
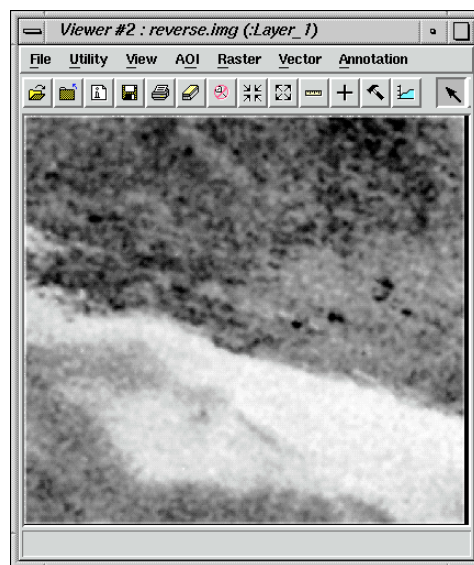
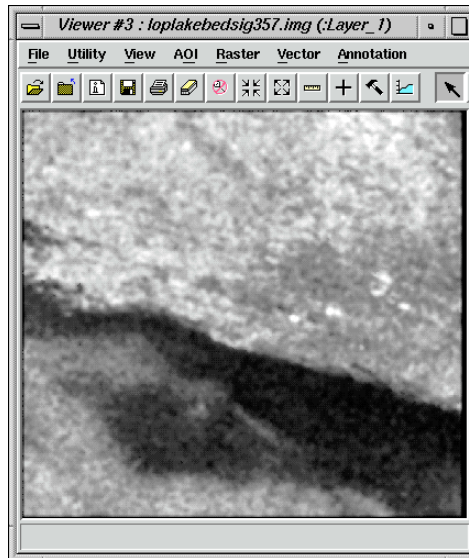

10. When you are through, close all three Viewers by selecting **Session | Close All Viewers** from the ERDAS IMAGINE menu bar.
11. Click **Close** in the **Radiometric Enhance** menu.

*NOTE: Do not close the **Image Interpreter** menu, as you continue using it in the next section.*



# Image Interpreter

## Apply Spectral Enhancement

1. In the **Image Interpreter** menu, click on **Spectral Enhancement**.

The **Spectral Enhancement** menu opens.

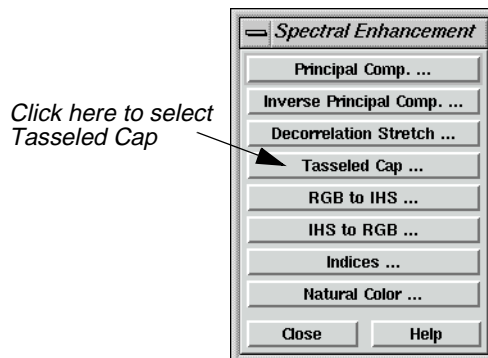

In this section, you use the following Spectral Enhancement functions:

- Tasseled Cap
- RGB to IHS
- IHS to RGB
- Indices

### Use Tasseled Cap

1. In the **Spectral Enhancement** menu, select **Tasseled Cap**.

The Tasseled Cap dialog opens.

## Apply Spectral Enhancement

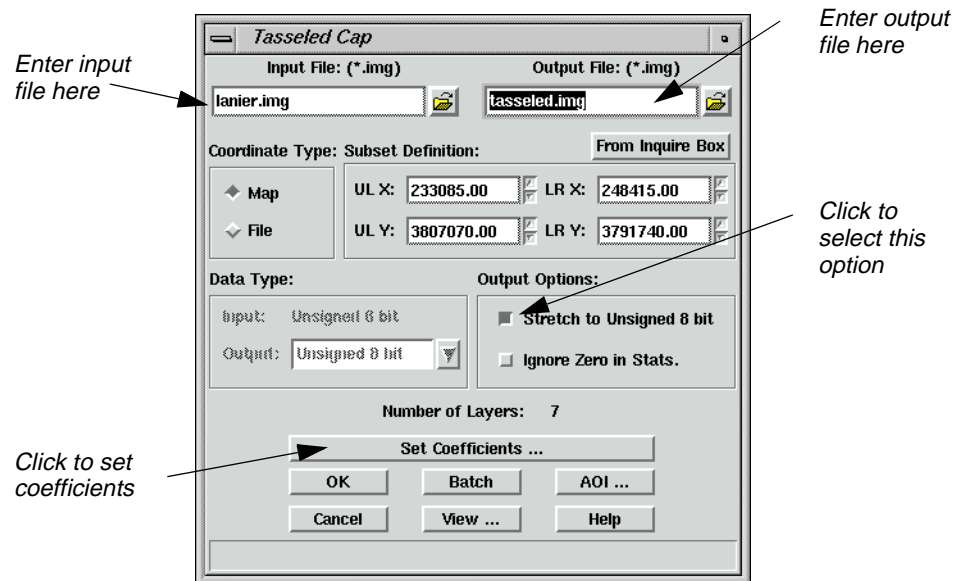

2. Under **Input File**, enter **lanier.img**. That image is a Landsat TM image of Lake Lanier, Georgia, which was obtained by the Landsat 5 sensor.
3. Enter **tasseled.img** in the directory of your choice as the **Output File** name.
4. Under **Output Options**, turn on the **Stretch to Unsigned 8 bit** checkbox by clicking on it.
5. Click on **Set Coefficients**.

The Tasseled Cap Coefficients dialog opens.

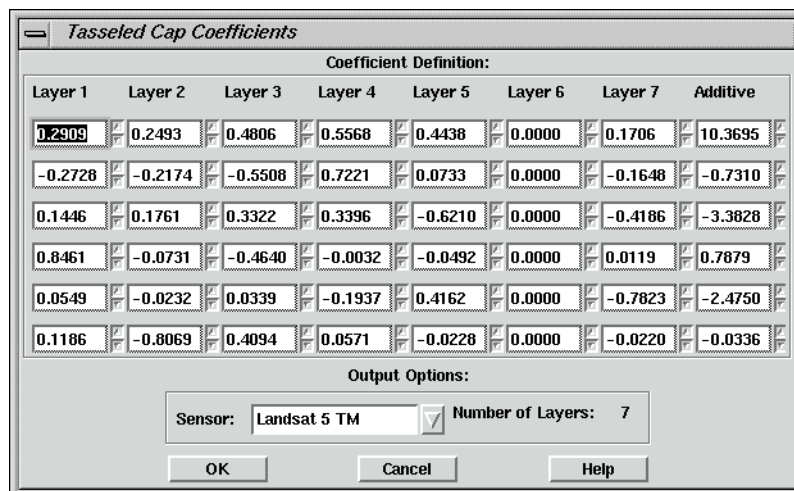

## Image Interpreter

The coefficients that display are the standard default entries for Landsat 5 TM Tasseled Cap transformation. For this exercise, you use the default entries, although you may change these entries at any time.

6. Click **OK** in the Tasseled Cap Coefficients dialog.
7. Click **OK** in the Tasseled Cap dialog to start the function.  
A Job Status dialog opens to report the state of the job.
8. When the Job Status dialog indicates that the job is **Done**, click **OK**.

### Check Results

1. Open a Viewer and display **lanier.img**.
2. Open a second Viewer and then open the Select Layer To Add dialog by clicking on the Open icon in the Viewer tool bar.
3. In the Select Layer To Add dialog, enter the name of the directory in which you saved **tasseled.img**, press Return on your keyboard, and then click **tasseled.img** in the file list to select it.
4. Click the **Raster Options** tab at the top of the Select Layer To Add dialog. Under **Layers to Colors**, use layer 1 as **Red**, layer 2 as **Green**, and layer 3 as **Blue**.
5. Click **OK** in the Select Layer To Add dialog.

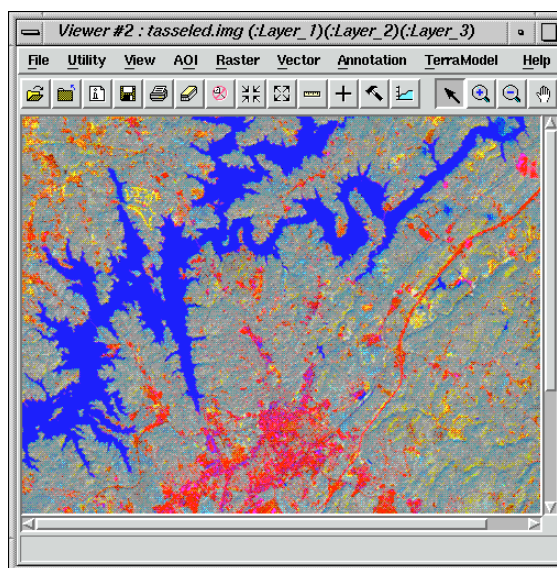

The image, **tasseled.img**, shows a degree of brightness, greenness, and wetness, as calculated by the Tasseled Cap coefficients used.

- Layer 1 (red) = the brightness component (indicates areas of low vegetation and high reflectors)

## Apply Spectral Enhancement

- Layer 2 (green) = the greenness component (indicates vegetation)
  - Layer 3 (blue) = the wetness component (indicates water or moisture)
6. When you are through, close the Viewers by selecting **Session | Close All Viewers** from the ERDAS IMAGINE menu bar.

### Use the Indices Function

Next, you apply a mineral ratio from the **Indices** function to a Landsat TM image. Such ratios are commonly used by geologists searching for specific mineral deposits in the earth.



For more information on this transformation, see "CHAPTER 5: Enhancement" in the ERDAS Field Guide.

1. In the **Spectral Enhancement** menu, select **Indices**.

The Indices dialog opens.

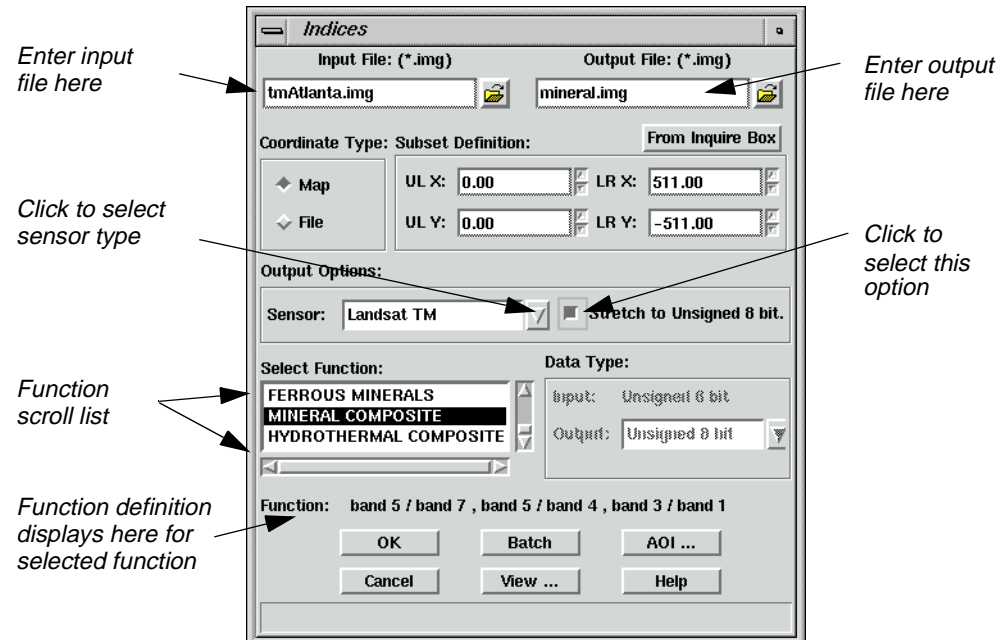

2. Under **Input File**, enter **tmAtlanta.img**.
3. Enter **mineral.img** in the directory of your choice as the **Output File**.
4. Under **Select Function**, click **MINERAL COMPOSITE** in the scrolling list.

This index is a composite of three mineral ratios.

- Clay minerals = band 5 / band 7
- Ferrous minerals = band 5 / band 4



# Image Interpreter

- Iron oxide = band 3 / band 1

*NOTE: Notice how the selected function is defined beside the **Function** label, underneath the **Select Function** scroll list.*

5. Under **Output Options**, turn on the **Stretch to Unsigned 8 bit** checkbox by clicking on it.
6. Click **OK** in the Indices dialog to start the process.

A Job Status dialog displays, indicating the progress of the function.

7. When the Job Status dialog indicates that the job is **Done**, click **OK**.

## Choose RGB to IHS

Next, you use the **RGB to IHS** function (red, green, blue to intensity, hue, saturation) and the reverse **IHS to RGB** function to enhance the image information obtained by this mineral ratio.

The purpose of this function is to produce an input file for the IHS to RGB function.

1. Select **RGB to IHS** from the **Spectral Enhancement** menu.

The **RGB to IHS** dialog opens.

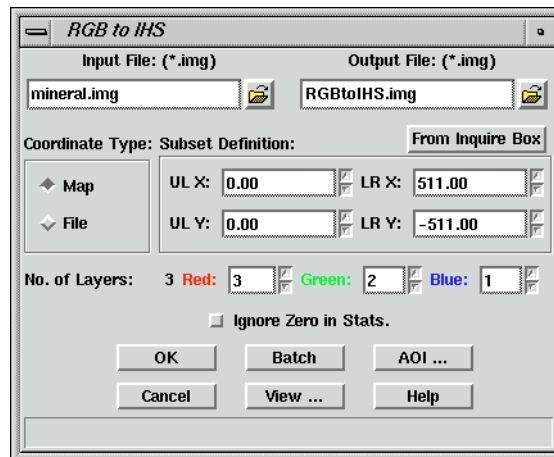

2. Enter the mineral ratio output from the previous exercise (**mineral.img**) as the **Input File**.
3. Enter **RGBtoIHS.img** (in the directory of your choice) as the **Output File**.
4. Click **OK** in the RGB to IHS dialog.

A Job Status dialog displays, reporting the progress of the function.

5. When the Job Status dialog indicates that the job is **Done**, click **OK**.

## Choose IHS to RGB

Now, you convert the IHS image back into an RGB image.

## Apply Spectral Enhancement

1. Select **IHS to RGB** from the **Spectral Enhancement** menu.

The IHS to RGB dialog opens.

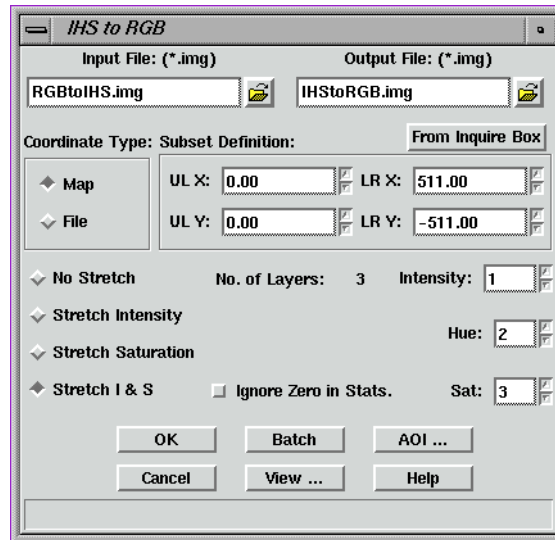

2. In the IHS to RGB dialog, enter **RGBtoIHS.img** output from the previous exercise as the **Input File**.
3. Enter **IHStoRGB.img** as the **Output File** in the directory of your choice.
4. On the IHS to RGB dialog, click **Stretch I & S**.

This option applies a global Min-Max contrast stretch to the Intensity and Saturation values in the image before converting.

5. Click **OK** in the IHS to RGB dialog.

A Job Status dialog displays, reporting the progress of the function.

6. When the Job Status dialog indicates that the job is **Done**, click **OK**.

### View the Results

1. Open three Viewers and then open the following files for comparison.
  - **mineral.img**—mineral ratio index. Proper interpretation can reveal the presence or absence of iron, clay, or ferrous minerals.



## Image Interpreter

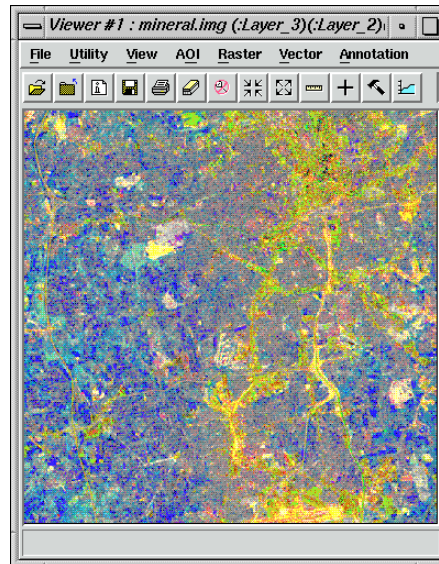

- **RGBtoIHS.img**—red, green, and blue values converted to intensity, hue, and saturation values. This image does not appear similar to the input file. It is not meant for interpretation; it is only meant to produce an input for the IHS to RGB function.

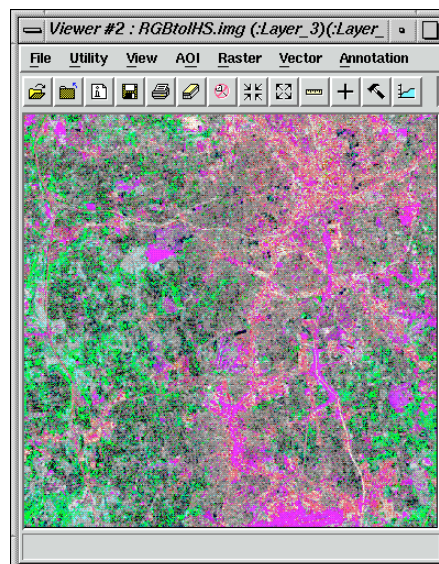

- **IHStoRGB.img** (see special instructions below)—intensity, hue, and saturation values converted to red, green, and blue values (appears similar to **mineral.img**). The intensity and saturation (red and blue) values have been contrast-stretched for better interpretation.



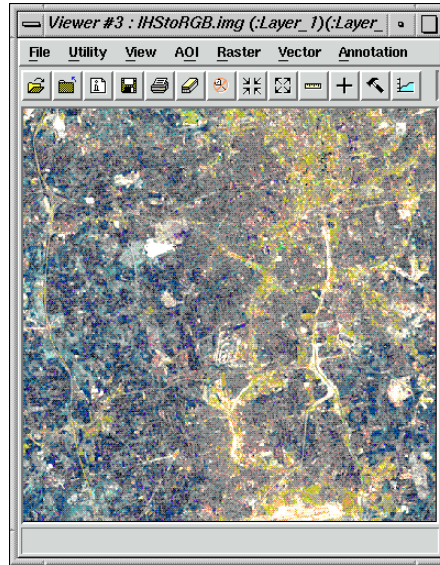

---

*In the Open Raster Layer dialog, when displaying **IHStoRGB.img**, be sure to load Layer 1 as Red, Layer 2 as Green, and Layer 3 as Blue. This is because the order of the layers was reversed in the transformation.*

2. When you are through comparing the files, close the Viewers by selecting **Session | Close All Viewers** in the ERDAS IMAGINE menu bar.
3. Click **Close** in the **Image Interpreter** menu.

The **Image Interpreter** and **Spectral Enhancement** menus close.



---

*For more information about Image Interpreter, see "APPENDIX A: Additional Information" on page 595.*



# Image Interpreter



# CHAPTER 12

## Orthorectification

---

### Introduction

Rectification is the process of projecting the data onto a plane and making it conform to a map projection system. Assigning map coordinates to the image data is called georeferencing. Since all map projection systems are associated with map coordinates, rectification involves georeferencing.

The orthorectification process removes the geometric distortion inherent in imagery caused by camera/sensor orientation, topographic relief displacement, and systematic errors associated with imagery. Orthorectified images are planimetrically true images that represent ground objects in their true “real world” X and Y positions. For these reasons, orthorectified imagery has become accepted as the ideal reference image backdrop necessary for the creation and maintenance of vector data contained within a GIS.

By performing space resection, the effects of camera/sensor orientation have been considered and removed. By defining a DEM or constant elevation value (ideal for use in areas containing minimal relief variation), the effects of topographic relief displacement can be considered and removed.



---

*For information on block bundle adjustment, see the IMAGINE OrthoBASE™ Tour Guide and the IMAGINE OrthoBASE™ User’s Manual.*



---

*Approximate completion time for this tour guide is 30 minutes.*

---

### Rectify a Camera Image

#### Perform Image to Image Rectification

In this tour guide, you orthorectify a camera image of Palm Springs, California, using a NAPP (National Aerial Photography Program) photo.

In rectifying the camera image, you use these basic steps:

- display Camera image
- start Geometric Correction Tool
- enter the Camera model properties
- record GCPs
- resample or calibrate the image



# Orthorectification

## Prepare

ERDAS IMAGINE should be running and a Viewer open. You must have write permission in a file if you wish to calibrate it. In a command shell, copy **ps\_napp.img** to a directory in which you have write permission and at least 10 Mb of space. Set the permissions on **ps\_napp.img** to read, write, execute using the `chmod 777 ps_napp.img` command (on UNIX).

Next, you should verify that **ps\_napp.img** has no map or projection information. Select **Tools | Image Information** from the ERDAS IMAGINE menu bar. Open your copy of **ps\_napp.img**. Select **Edit | Delete Map Model** and click **Yes** in the Attention dialog that opens. Close the ImageInfo dialog, and begin this exercise.

1. Select **File | Open | Raster Layer** from the Viewer menu bar, or click the Open icon in the Viewer tool bar.



The Select Layer To Add dialog opens.

2. In the Select Layer To Add dialog under **Filename**, select **ps\_napp.img** from the directory into which you copied it.
3. Click **OK** in the Select Layer To Add dialog to display the camera image in the Viewer.

The file **ps\_napp.img** opens in the Viewer. The Viewer image is displayed with a view of the top, left corner of the photo, as shown in the following picture:

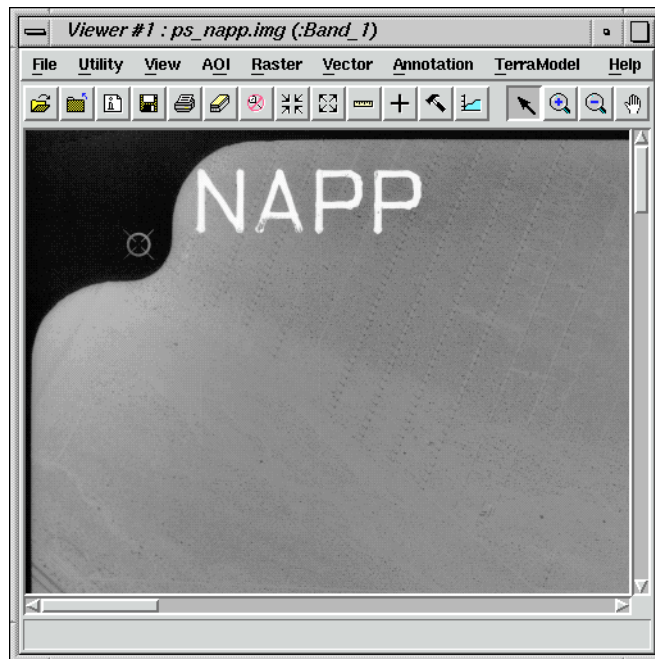

## Check for Map Model

Before you continue with geometric correction, you must first make sure that the image does not already have a map model.

1. From the Viewer tool bar, click the ImageInfo icon.



The ImageInfo dialog opens.

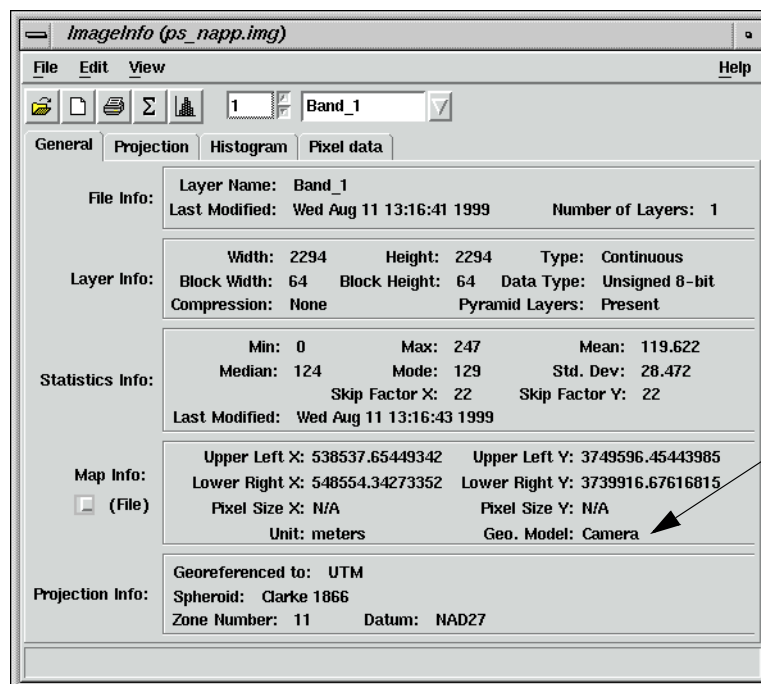

2. Look in the **Geo. Model** section. If the **Geo. Model** section says **Camera**, you must delete the map model, therefore, proceed to step 3. If there is no model, proceed to "Perform Geometric Correction" on page 270.
3. Select **Edit | Delete Map Model** from the ImageInfo menu bar.
4. Select **File | Close** from the ImageInfo menu bar.

## Redisplay the file

1. Click the Close icon in the Viewer currently displaying **ps\_napp.img**.



## Orthorectification

2. Click the Open icon, and select **ps\_napp.img** from the directory in which you saved it.



3. Move your cursor around the image and note the small coordinates in the status area.

The small coordinates are pixel coordinates, not map coordinates. You can now proceed with geometric correction.

### Perform Geometric Correction

1. Select **Raster | Geometric Correction** from the Viewer menu bar.

The Set Geometric Model dialog opens.

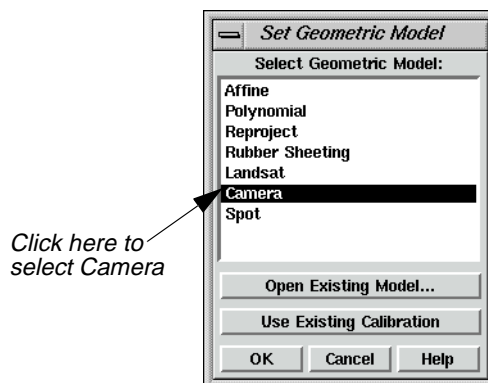

2. In the Set Geometric Model dialog, click on **Camera**, and then click **OK**.

The Geo Correction Tools open.



The Camera Model Properties dialog also opens.

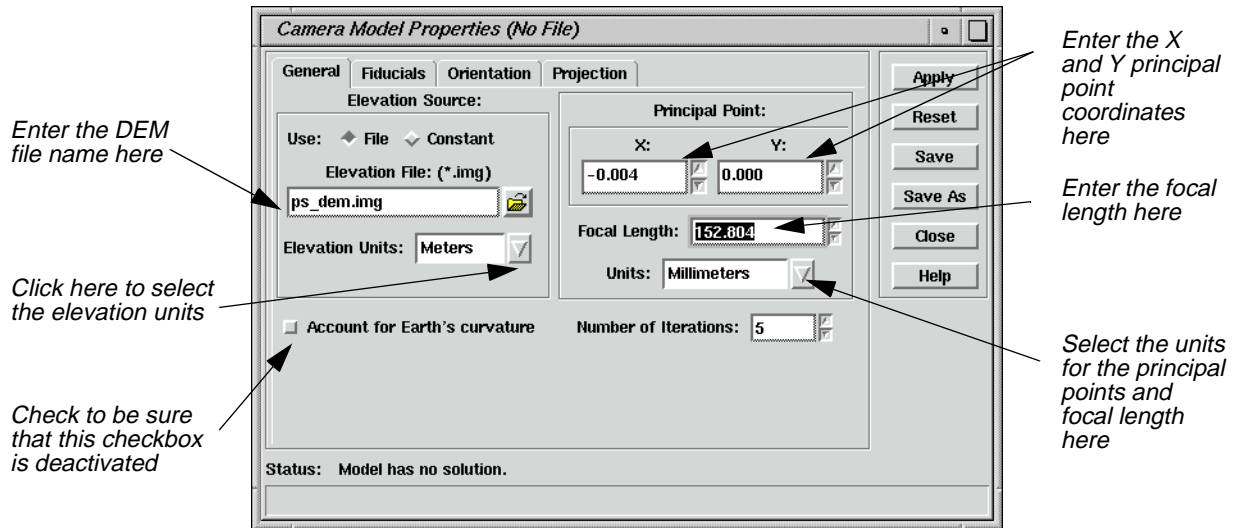

## Set Camera Model Properties

1. In the Camera Model Properties dialog, enter the DEM file (**ps\_dem.img**) under **Elevation File**.

*NOTE: Upon request, the data provider supplies the camera calibration certificate with the film at the time of purchase. This certificate provides the information needed for steps (2. and 3.*

2. In the Camera Model Properties dialog under **Principal Point**, enter **-0.004** for **X** and accept **0.000** as the default for **Y**. Then enter **152.804** for the **Focal Length**.

*NOTE: From the camera calibration certificate, there may be several possible types of the Principal Point coordinates. The Principal Point of Symmetry is preferable.*

3. In **Units** under **Principal Point**, accept the default of **Millimeters**.

*NOTE: The **X** and **Y** Principal Point coordinates, **Focal Length**, and **Fiducial Film** coordinates must all be entered in the same units.*

4. For this example, make sure that the **Account for Earth's curvature** checkbox not selected.



*You should only account for the Earth's curvature when using small-scale images or when it is necessary to take this factor into account. Alternately activating and deactivating this option (and then clicking **Apply**) allows you to observe changes to the RMS error. Accounting for the Earth's curvature slows down the rectification process.*

## Edit Fiducials

1. Click on the **Fiducials** tab at the top of the Camera Model Properties dialog.

The Fiducial options display.



# Orthorectification

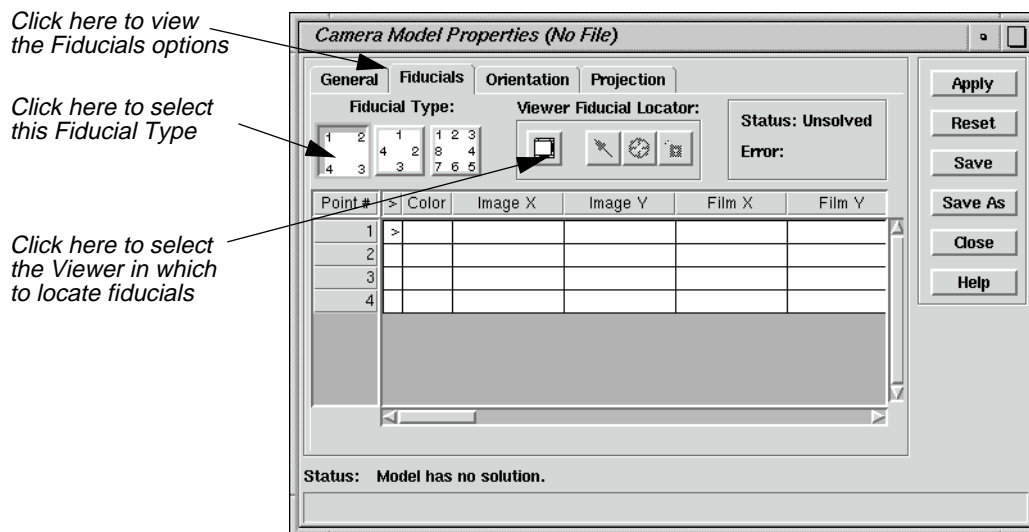

- Under **Fiducial Type**, click the first icon.



- Under **Viewer Fiducial Locator**, click the Toggle icon.



- Follow the instructions by clicking in the Viewer that contains **ps\_napp.img**.

A link box opens in the first Viewer, and the Chip Extraction Viewer also displays (the second Viewer).

- In the first Viewer, drag the link box to the point in the image you want to digitize (as illustrated in the following example). Place the center of the link box on the dot at the center of the point (where the crosshair intersects).

*NOTE: Identifying the dot may sometimes require Breakpoint/LUT adjustments.*



## Rectify a Camera Image

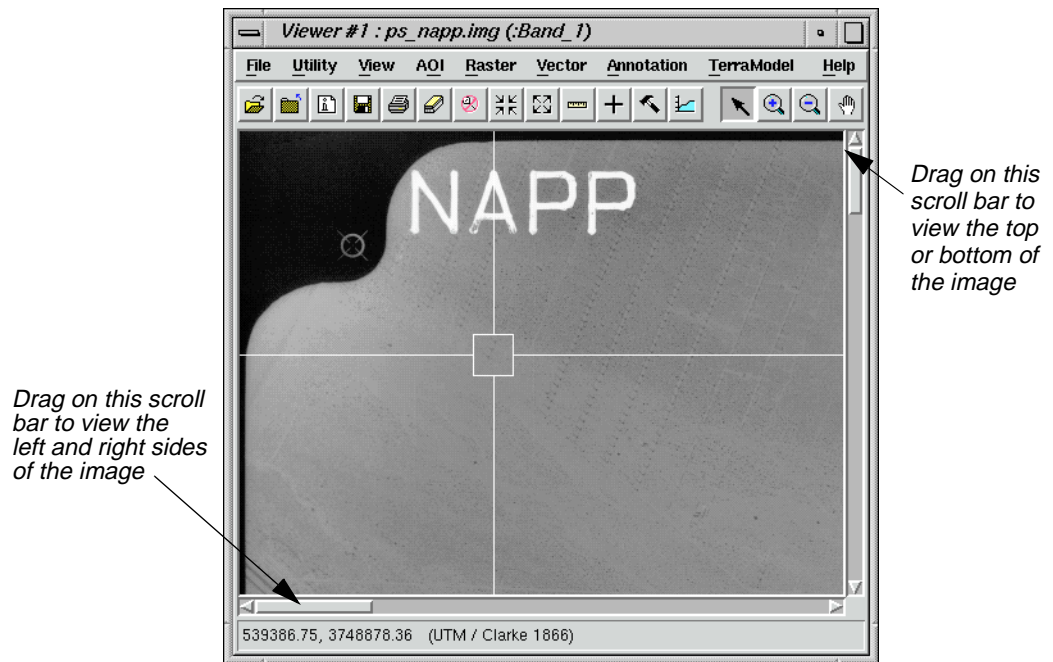

The second Viewer displays the point in the image that you have chosen with the link box.

6. In the Camera Model Properties dialog, click the Place Image Fiducial icon.



Move your cursor into the Chip Extraction Viewer (the second Viewer), and click on the center point where the crosshair intersects.

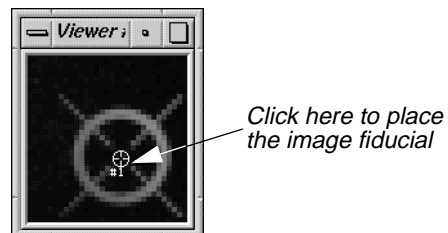

The point coordinates display under **Image X** and **Image Y** in the Fiducials CellArray of the Camera Model Properties dialog.

7. Create three more fiducials by repeating steps (5. and 6. for the points in the three other corners of the image in the first Viewer. Move clockwise around the image in the Viewer, using the Viewer scroll bars, as shown in the following diagram:



# Orthorectification

Drag the scroll bars to view the image in clockwise order

Begin digitizing here (point #1)

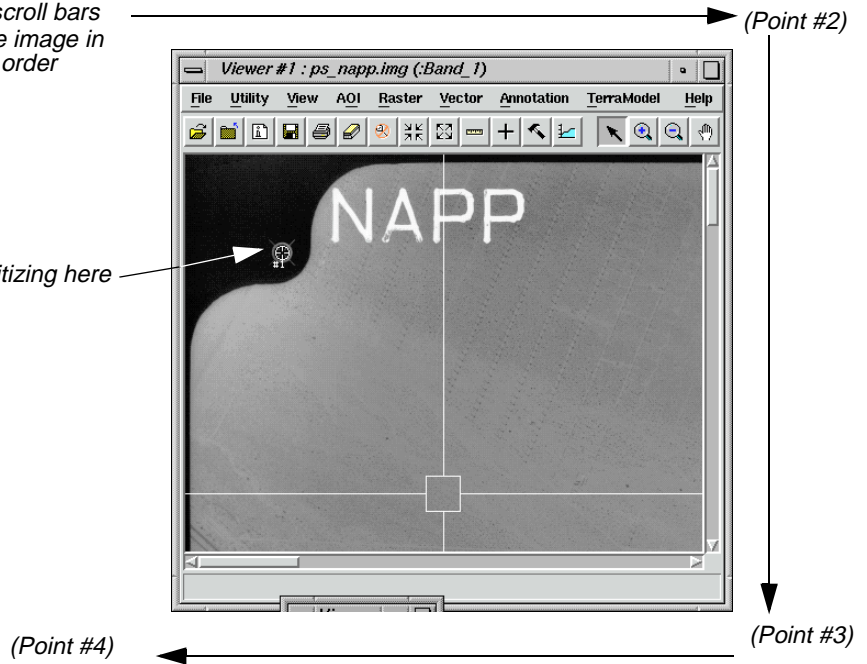

It is crucial that you follow step 7. exactly to match the points with the coordinates in step 1.

## Enter Film Coordinates

1. It is necessary to enter the **Film** coordinates into the Camera Model Properties dialog manually. The data provider can include this information in the camera calibration certificate.

Being sure to match the point numbers with the proper coordinates, enter the **Film X** and **Film Y** coordinates from the following table:

**Table 12-1: Film X and Film Y Coordinates**

Point #	Film X	Film Y
1	-106.000	106.000
2	105.999	105.994
3	105.998	-105.999
4	-106.008	-105.999

When the last **Film** coordinate has been entered in the Camera Model Properties dialog, the **Status** changes to **Solved** and the **Error** is calculated. This indicates that the interior orientation parameters have been solved.

## Rectify a Camera Image

An error of less than **1.0000** is acceptable. An error of greater than **1.0000** indicates that the points were inaccurately measured or poorly identified.

2. In the Camera Model Properties dialog under **Viewer Fiducial Locator**, click the Toggle icon.



The Chip Extraction Viewer (the second Viewer) closes.

3. Click on the **Orientation** tab in the Camera Model Properties dialog.

The Orientation options display.

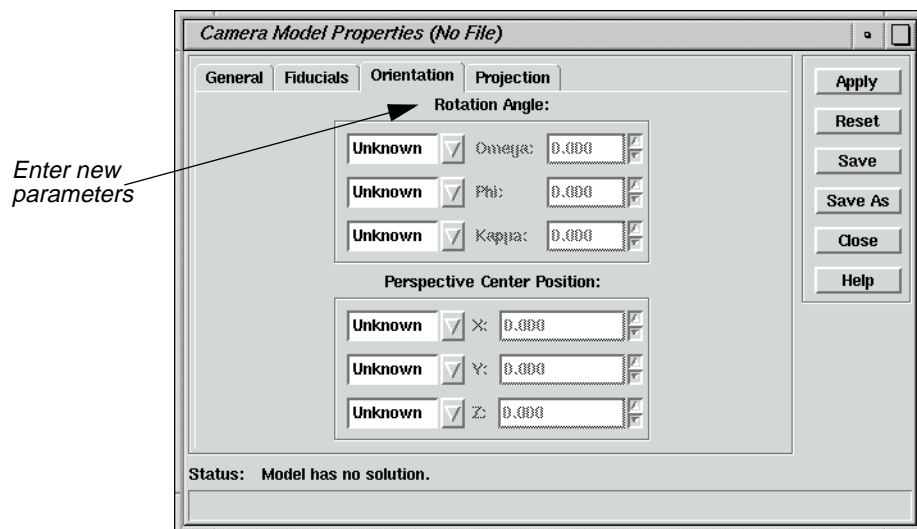

If you have known parameters for the **Rotation Angle** and **Perspective Center Position** derived from another triangulation package, or if you have estimated values, you can enter them in the **Orientation** tab. Select the appropriate settings: **Unknown**, **Estimate**, or **Fixed**.

If no changes are being made to the **Orientation**, you do not need to click **Apply** (therefore, it is deactivated).

*NOTE: If **Account for Earth's curvature** is selected under the **General** tab (see step 4.), then the **Orientation** options are disabled.*

### Change Projection

1. Click on the **Projection** tab in the Camera Model Properties dialog.

The Projection options display.

2. In the Projection options, click on **Add/Change Projection**.



# Orthorectification

The Projection Chooser dialog opens.

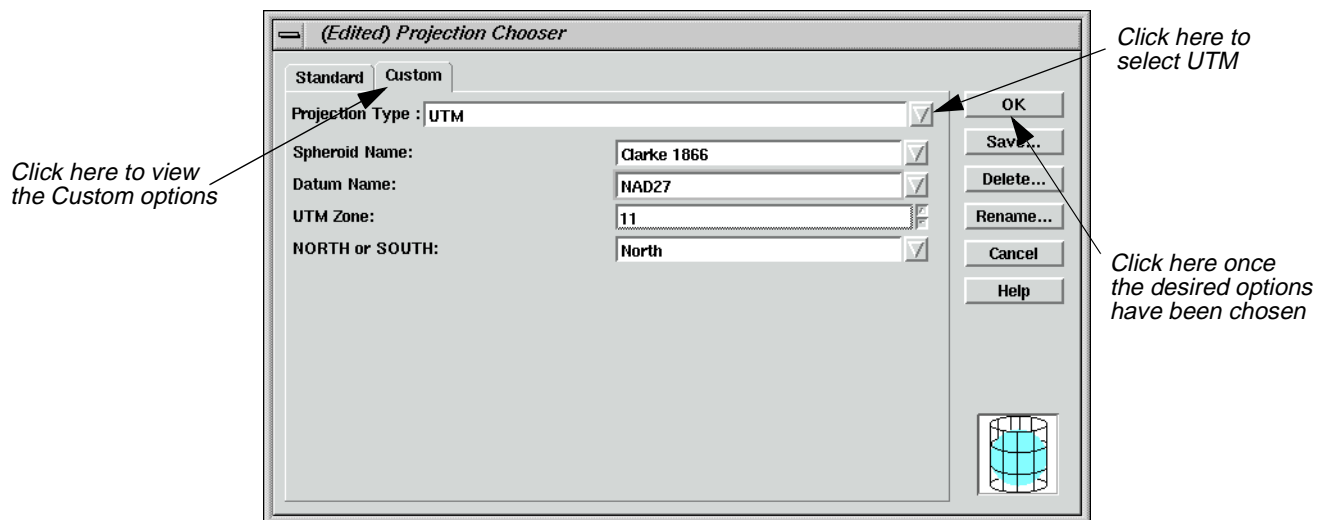

3. In the Projection Chooser dialog, click on the **Custom** tab.
4. Confirm that **Projection Type** lists **UTM**.
5. Confirm that **Datum Name** lists **NAD27**.
6. Confirm that **11** is the **UTM Zone**.
7. Click **OK** in the Projection Chooser dialog.

The projection information you just entered displays under **Current Reference Map Projection** in the Camera Model Properties dialog.

8. In the Camera Model Properties dialog, click on the popup list next to **Map Units** and select **Meters** (this activates the **Apply** button).
9. Click **Apply** and then **Save As** in the Camera Model Properties dialog.

## Name the Geometric Model

1. The Geometric Model Name dialog opens.
2. In the Geometric Model Name dialog under **Filename**, enter the name **GeoModel** in the directory of your choice. The .gms file extension is added automatically.
3. Click **OK** in the Geometric Model Name dialog.

## Start the GCP Tool and compute RMS Error

1. In the Geo Correction Tools, click on the GCP Tool icon.



The GCP Tool Reference Setup dialog opens.

2. In the GCP Tool Reference Setup dialog, select **GCP File** under **Collect Reference Points From**, and then click **OK**.

The Reference GCC File dialog opens.

3. In the Reference GCC File dialog under **Filename**, select **ps\_camera.gcc**.

The reference points in this file were obtained from USGS 1:24,000 scale topographical maps using a digitizer.

4. Click **OK** in the Reference GCC File dialog.

A Chip Extraction Viewer (the second Viewer), a link box, and the GCP Tool open.

Point #	Point ID	Color	X Input	Y Input	X Ref.	Y Ref.	Z Ref.	Type
1	GCP #1	Red	1401.178	-2101.550	544657.897	3740719.772	118.872	Control
2	GCP #2	Red	850.167	-2214.532	542301.251	3740224.479	132.588	Control
3	GCP #3	Red	808.021	-571.726	541989.315	3747260.594	188.366	Control
4	GCP #4	Red	1270.101	-1271.888	544030.350	3744286.400	147.218	Control
5	GCP #5	Red	1687.295	-590.503	545787.266	3747269.691	159.105	Control

*These file coordinates were previously measured and saved in the source file, ps\_napp.img*

*These reference coordinates are from the ps\_camera.gcc file*

5. In the GCP Tool, click on the Calculate icon.



*NOTE: The orthorectification models do not have the option of Automatic Transform Calculation.*



# Orthorectification

Clicking this icon solves the model and calculates the RMS error and residuals. The **Control Point Error** for the **X** and **Y** values is displayed in the upper, right-hand corner of the GCP Tool.

*NOTE: The GCP Tool requires a minimum of three GCPs to run the model and at least six GCPs to make the model accurate and stable.*

6. Click **Save** in the Camera Model Properties dialog.

## Resampling vs. Calibration

### Resampling

Resampling is the process of calculating the file values for the rectified image and creating the new file. All of the raster data layers in the source file are resampled. The output image has as many layers as the input image.

ERDAS IMAGINE provides these widely-known resampling algorithms:

- Nearest Neighbor
- Bilinear Interpolation
- Cubic Convolution

### Calibration

Instead of creating a new, rectified image by resampling the original image based on the mathematical model, calibrating an image only saves the mathematical model into the original image as a piece of auxiliary information. Calibration does not generate new images, so when the calibrated image is used, the math model comes into play as needed.

For example, if you want to see the calibrated image in its rectified map space in a Viewer, the image can be resampled on the fly based on the math model, by selecting the **Orient image to map system** option in the Select Layer To Add dialog.

A major drawback to image calibration is that the processes involved with the calibrated image is slowed down significantly if the math model is complicated. One minor advantage to image calibration is that it uses less disk space and leaves the image's spectral information undisturbed.



*It is recommended that image calibration be used only when necessary, due to the drawbacks of the process.*

### Choose Your Path

- If you would like to resample the camera image, proceed to "Resample the Image" on page 279.
- If you would like to calibrate the camera image, proceed to "Calibrate the Image" on page 280.

## Resample the Image

### Prepare

Resampling requires an input file and a transformation matrix by which to create the new pixel grid.

1. In the Geo Correction Tools, click on the Resample icon.



The Resample dialog opens.

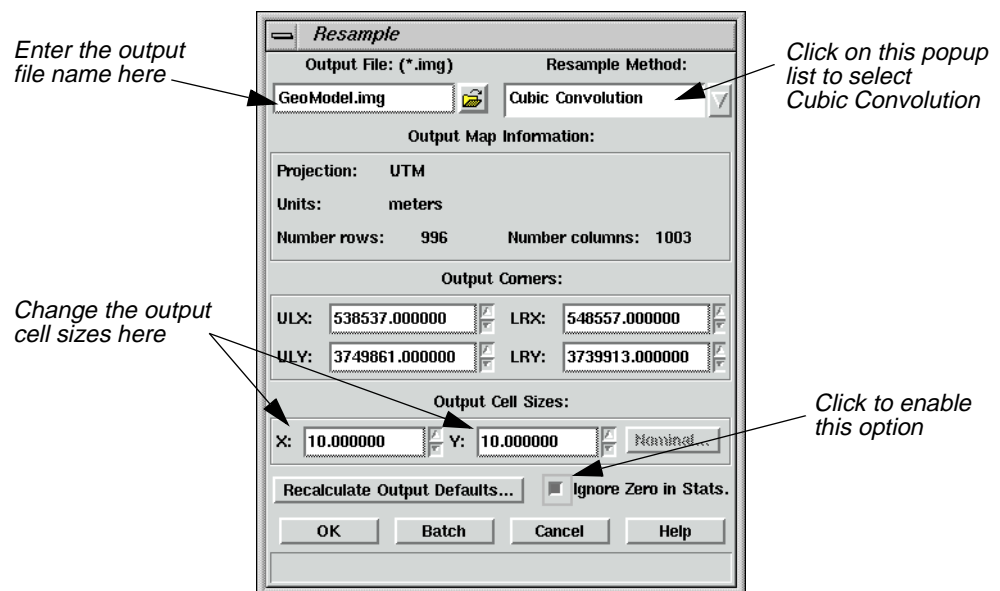

2. In the Resample dialog under **Output File**, enter **GeoModel.img** in the directory of your choice.
3. Under **Resample Method**, click on the popup list and select **Cubic Convolution**.
4. Under **Output Cell Sizes**, enter **10** for **X** and **10** for **Y**.

*NOTE: The default **Output Cell Sizes** are based on the triangulation. The smaller the pixel size, the larger the output file size.*

5. Click the **Ignore Zero in Stats.** checkbox to activate it.
6. Click **OK** in the Resample dialog.

A Job Status dialog displays, indicating the progress of the function.

7. When the Job Status dialog indicates that the process is 100% complete, click **OK**.
8. Display **GeoModel.img** in a Viewer to view the resampled orthoimage.



# Orthorectification

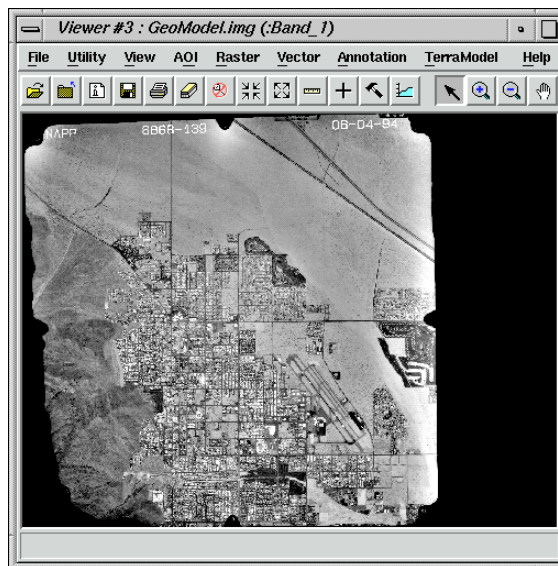

## Calibrate the Image

### Prepare

You must have completed the steps to rectify **ps\_napp.img** on pages 267 through 278.

1. In the Geo Correction Tools, click on the Calibrate Image icon.



A Calibrate Image warning box displays, indicating that “performing image calibration requires the termination of the Geo Correction Tool and reopening the image in the Viewer.”

2. Click **OK** in the Calibrate Image warning box.

The Geo Correction Tool and all its associated dialogs close. The file **ps\_napp.img** closes and then reopens in the Viewer, with the **Orient Image to Map System** option turned off.

3. To apply the calibration to the image in the Viewer, redisplay the output image with the **Orient Image to Map System** option turned on.

*NOTE: Once calibrated, this image cannot be reused in the orthorectification process using the information/coordinates files provided. Calibration must be deleted (**Edit | Delete Map Model** in the ImageInfo dialog) for this file to be used again for this tour guide.*

4. In the Viewer, click on the Info icon to view the calibration information.



The ImageInfo dialog opens, displaying the information for the calibrated image.



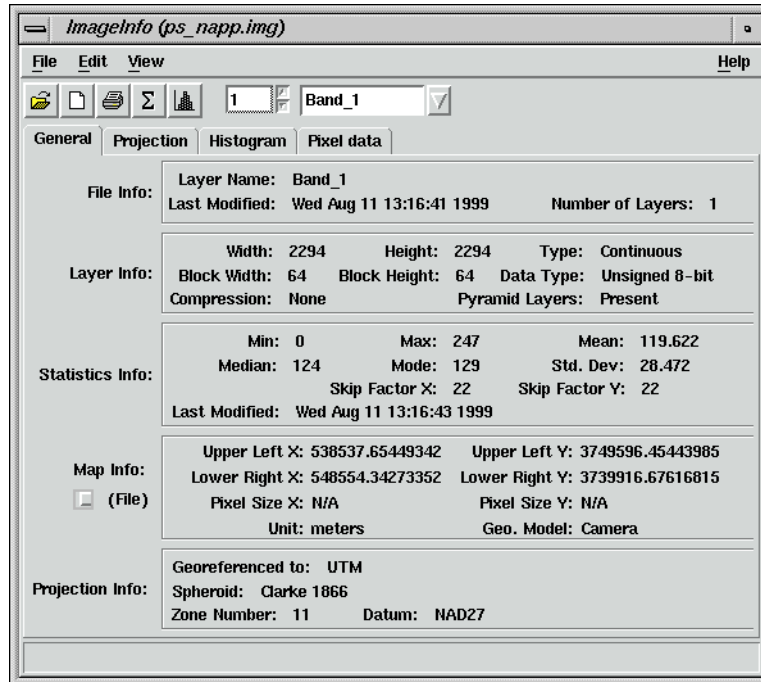

For more information about rectification, see "APPENDIX A: Additional Information" on page 595.



For a more in-depth discussion of the concepts behind rectification, see "CHAPTER 9: Rectification" of the *ERDAS Field Guide*.



# Orthorectification



# CHAPTER 13

## Terrain Surface Interpolation

---

### Introduction

The Surfacing Tool enables you to create a three-dimensional surface from irregularly spaced points. Supported input data include:

- ASCII point files
- Arc point and line coverages
- ERDAS IMAGINE \*.ovr layers
- existing raster images (IMG)

All input data sources must have X, Y, and Z values. Surface Interpolation calculates Z values at spatial locations where no Z samples exist in the input data source. The output is a continuous raster image that contains Z values calculated from the interpolation process.

The ERDAS IMAGINE Surface Tool uses a TIN interpolation method. At each point where there is a known value, that known value remains unchanged in the output surface. Where the value is not known, it is interpolated from the surrounding known values.

Two TIN interpolation methods are available in the Surface Tool: Linear and Nonlinear. The Linear interpolation method, which makes use of a first-order polynomial equation, results in the TIN triangles being defined as angular planes. The Nonlinear interpolation method, which uses a fifth-order polynomial, results in a smooth surface. In this case, the TIN triangle areas are not considered to be planes, but areas that have rubber sheet characteristics. The Linear interpolation method is quicker and the results more predictable. However, the Nonlinear interpolation method produces more continuous results from irregularly distributed data sets where the observed phenomena has a rolling, nonangular surface characteristic.



---

*Approximate completion time for this tour guide is 15 minutes.*

---

### Create a Surface

#### Prepare

ERDAS IMAGINE must be running and a Viewer open.

1. Click on the DataPrep icon on the ERDAS IMAGINE icon panel.



The **Data Preparation** menu opens.



# Terrain Surface Interpolation

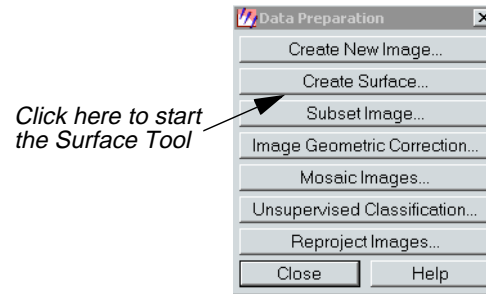

2. In the **Data Preparation** menu, click **Create Surface**.

The 3D Surfacing dialog opens.



3. Click **Close** in the **Data Preparation** menu to clear it from the screen.

## Import an ASCII File

1. In the 3D Surfacing dialog, click the Read Points icon.



The Read Points dialog opens.

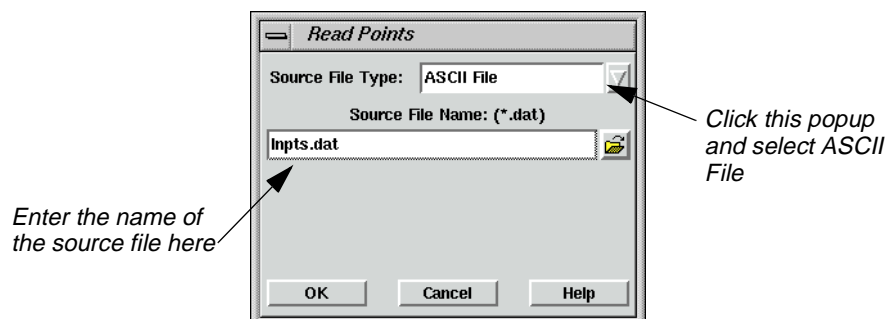

- In the Read Points dialog, click on the popup next to **Source File Type** and select **ASCII File**.
- Under **Source File Name**, enter **Inpts.dat**.



This file is located in the <IMAGINE\_HOME>/examples directory, where <IMAGINE\_HOME> is the location of ERDAS IMAGINE on your system.

- Click **OK** in the Read Points dialog.

The Read Points dialog closes, and the Import Options dialog opens.

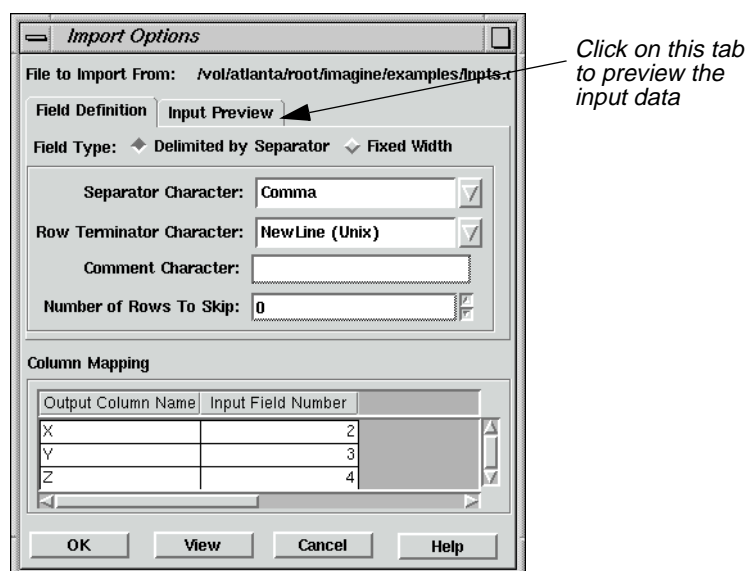

- In the Import Options dialog, click the **Input Preview** tab to see how the ASCII file is imported and mapped under the present parameter settings.



## Terrain Surface Interpolation

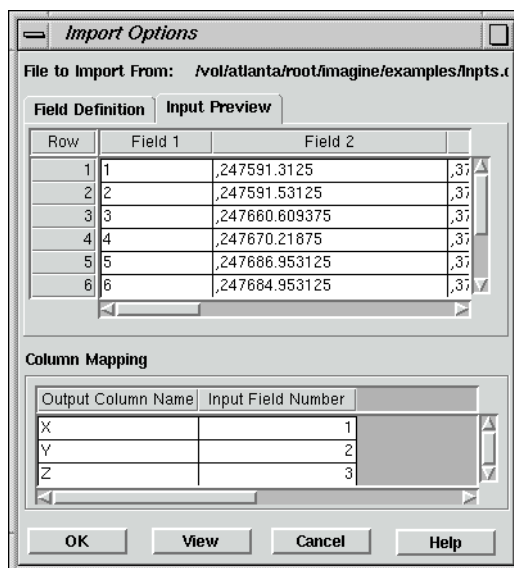

From the **Input Preview** display, you can tell that the **Separator Character** is the comma and that **Field 1** should be ignored.

6. Click the **Field Definition** tab.
7. Click on the popup list next to **Separator Character** and select **Comma**.
8. In the **Column Mapping** CellArray, alter the **Input Field Number** column values vertically from **1, 2, 3** to **2, 3, 4** in order to ignore the ID column of the input file.
9. Click **OK** in the Import Options dialog.

A Job Status dialog opens, reporting the progress of the function.

10. When the Job Status dialog shows that the process is 100% complete, click **OK**.

The **X**, **Y**, and **Z** columns of the 3D Surfacing CellArray are now populated with 4,411 rows of X, Y, and Z coordinates.

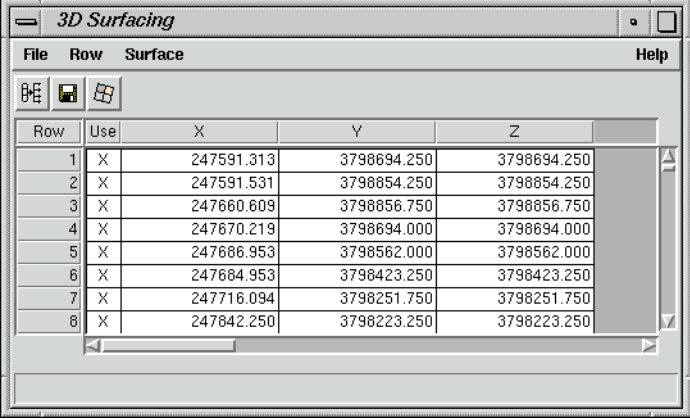

Row	Use	X	Y	Z
1	X	247591.313	3798894.250	3798894.250
2	X	247591.531	3798854.250	3798854.250
3	X	247660.609	3798856.750	3798856.750
4	X	247670.219	3798894.000	3798894.000
5	X	247686.953	3798562.000	3798562.000
6	X	247684.953	3798423.250	3798423.250
7	X	247716.094	3798251.750	3798251.750
8	X	247842.250	3798223.250	3798223.250

11. If you like, you can save these points as a **Point Coverage** (.arcinfo) or an **Annotation Layer** (.ovr) by selecting **File | Save As** from the 3D Surfacing dialog menu bar.

### Perform Surfacing

1. In the 3D Surfacing dialog, click the Perform Surfacing icon.



The Surfacing dialog opens. The extent and cell size defaults are filled in automatically, based on the source ASCII file.



# Terrain Surface Interpolation

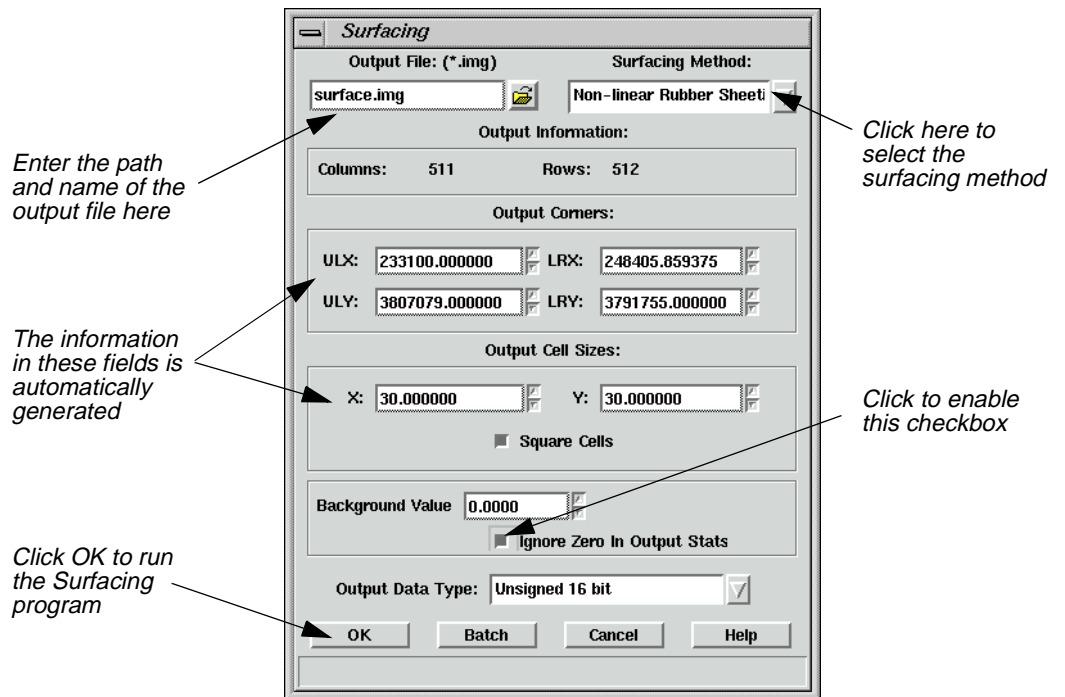

The two options for a surfacing method are **Linear Rubber Sheeting** (1st Order Polynomial solution) and **Non-linear Rubber Sheeting** (5th Order Polynomial solution).

2. Under **Output File**, enter the name of the output file (e.g., **surface.img**) in the directory of your choice.
3. Click on the popup list next to **Surfacing Method** and select **Non-linear Rubber Sheeting**.
4. Click the **Ignore Zero In Output Stats** checkbox to enable it.
5. Click **OK** in the Surfacing dialog.

A Job Status dialog displays, stating the progress of the function.

6. When the Job Status dialog reads that the function is 100% complete, click **OK** (if necessary).

## Display the Surface

1. Click the Open icon in a Viewer.



The Select Layer To Add dialog opens.

2. In the Select Layer To Add dialog under **Filename**, enter the name of the output file you created in step 2., beginning with the directory path in which you saved it.



3. Click **OK** in the Select Layer To Add dialog.

The output image is displayed in the Viewer for you to examine.

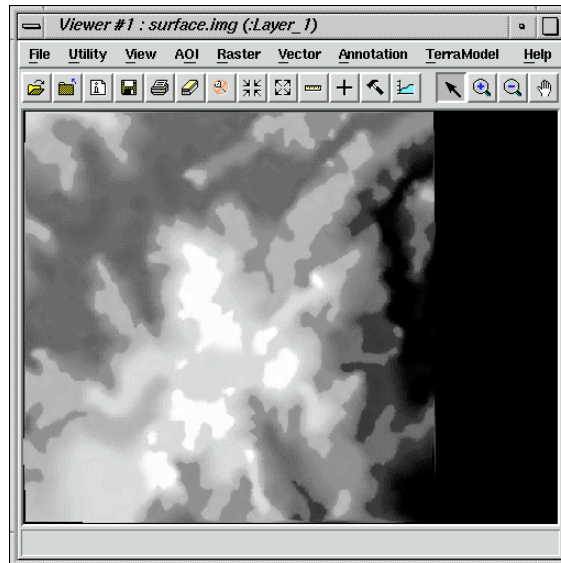

---

*To edit portions of the resulting surface, use the raster editing techniques described in "CHAPTER 1: Viewer", "Raster Editor" on page 34.*



---

*For more information see "Terrain Surface Editor" on page 637.*



# Terrain Surface Interpolation



# CHAPTER 14

## Mosaic

### Introduction

This tour guide gives you the steps for mosaicking two or more image files to produce one image file. The mosaicking process works with rectified and/or calibrated images. Here, you are shown how to mosaic air photo images as well as LANDSAT images.



Approximate completion time for this tour guide is 45 minutes.

### Mosaic Using Air Photo Images

In this section, you use a template to mosaic two air photo images.

The two files to be mosaicked are **air-photo-1.img** and **air-photo-2.img**.

These data files are air photo images of the Oxford, Ohio area.

### Prepare

ERDAS IMAGINE should be running and a Viewer should be open.

1. In the Viewer, select **File | Open | Raster Layer** or click the Open icon.



The Select Layer To Add dialog opens.

Click here to access the raster options

Click here to select the file

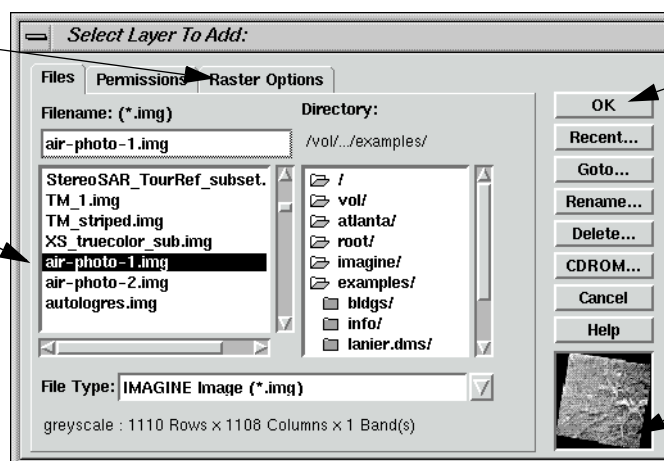

Click here to display the file

Preview window



## Mosaic

2. In the Select Layer To Add dialog under **Filename**, select **air-photo-1.img** from the file list.
3. Click the **Raster Options** tab at the top of the Select Layer To Add dialog.
4. Click the **Fit to Frame** option to enable it.
5. Click **OK** in the Select Layer To Add dialog.

The file **air-photo-1.img** displays in the Viewer.

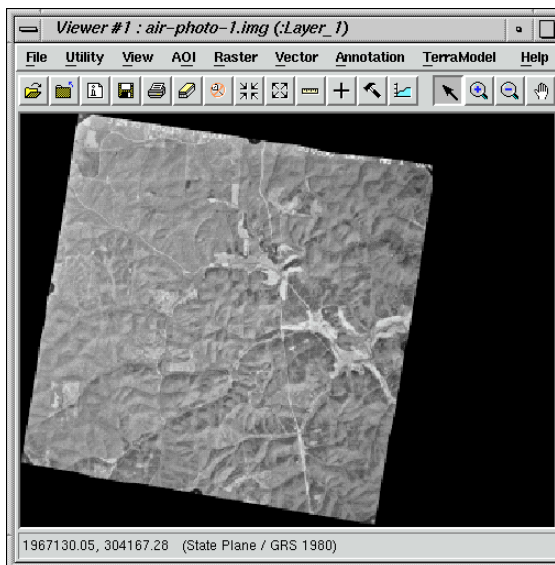

6. Click on the Viewer icon in the ERDAS IMAGINE icon panel to create a second Viewer.



7. Repeat steps (1. through (5. for the second Viewer, selecting **air-photo-2.img** this time.

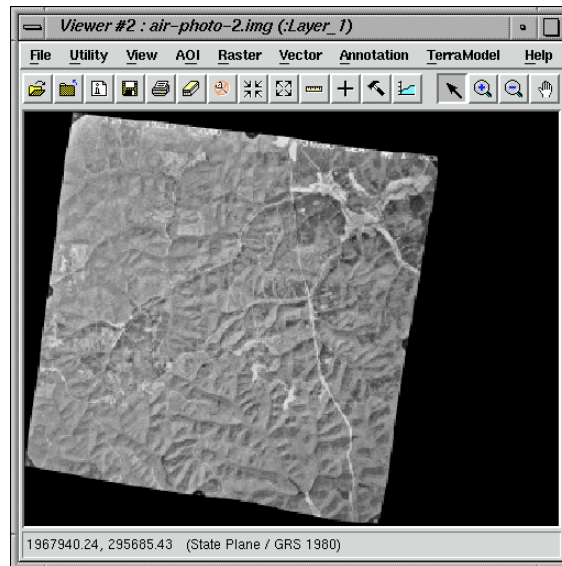

8. Position the Viewers side by side by selecting **Session | Tile Viewers** from the ERDAS IMAGINE menu bar.

You can resize each Viewer so that they take up less screen space by dragging any corner of the Viewer.

9. In the ERDAS IMAGINE icon panel, click on the DataPrep icon.



The **Data Preparation** menu displays.

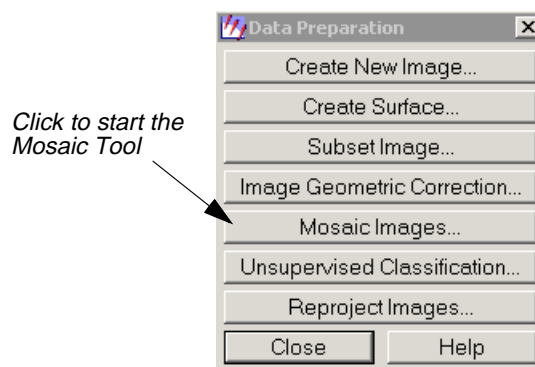

10. In the **Data Preparation** menu, select **Mosaic Images**.

The Mosaic Tool viewer opens.



# Mosaic

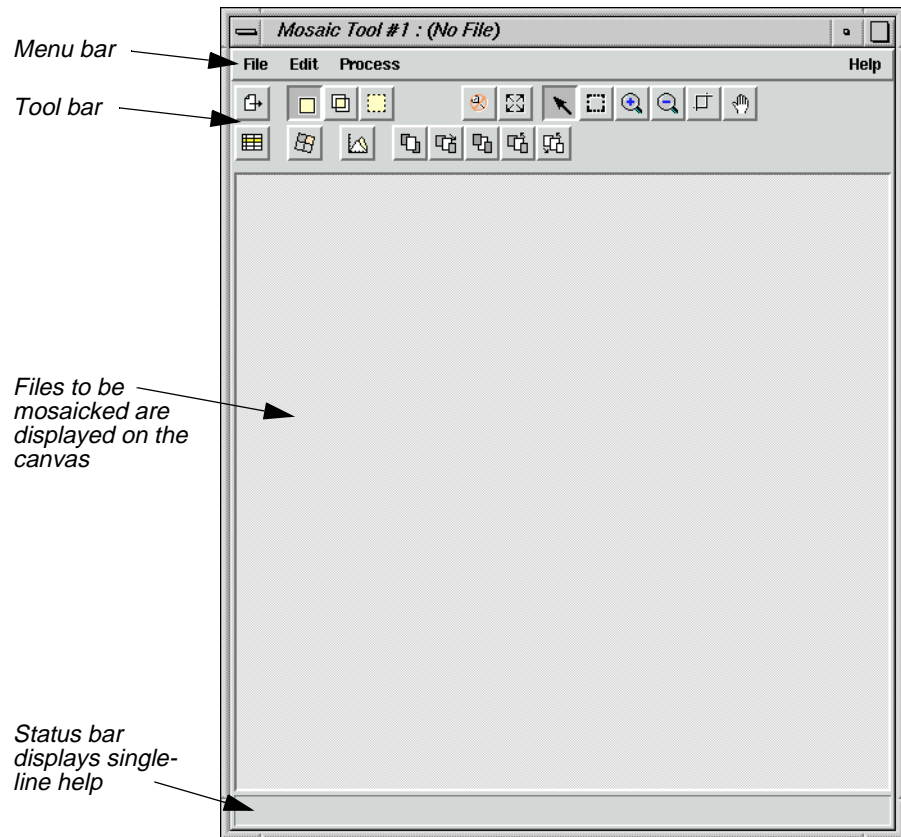

11. Click **Close** in the **Data Preparation** menu to clear it from the screen.

## Set Input Images

1. In the first Viewer containing **air-photo-1.img**, select **AOI | Tools**.

The AOI tool palette displays.



## Mosaic Using Air Photo Images

2. In the AOI tool palette, click on the Polygon icon.



3. In the first Viewer, draw a polygon around the entire image, outlining its shape, by dragging to draw lines and clicking to draw vertices (i.e., on-screen digitize the outline of the image). Middle-click to close the polygon.

*NOTE: If you do not have a three-button mouse, you can double-click to close the polygon.*

When you are finished, the AOI layer is highlighted with a dotted line and the image is surrounded by a bounding box. The image in the first Viewer should look like the following example:

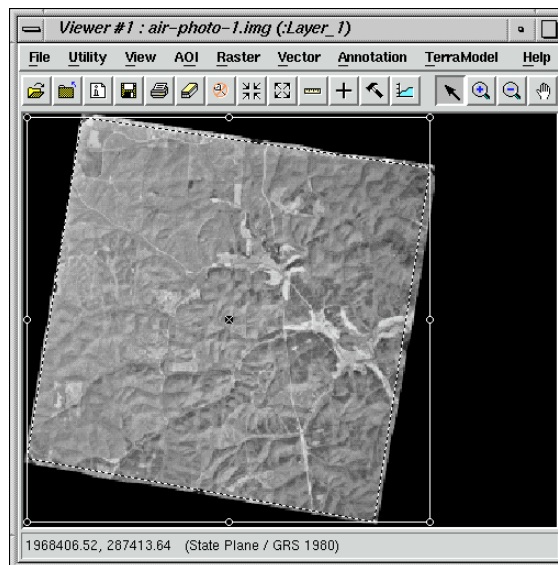

### Create a Template

1. When you have finished drawing the polygon, select **File | Save | AOI Layer As** in the first Viewer.

The Save AOI As dialog opens.



# Mosaic

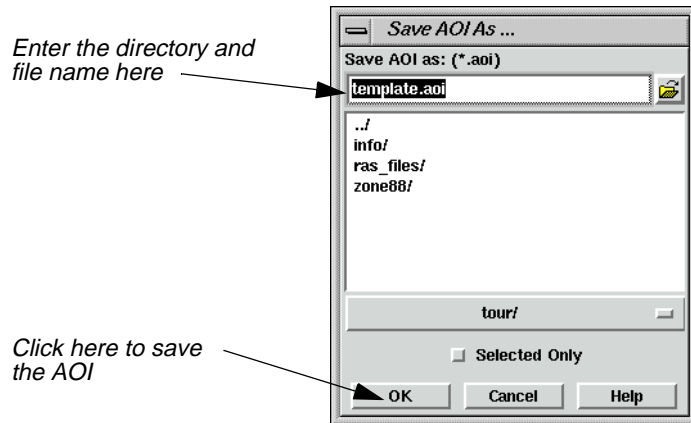

2. Under **Save AOI as**, enter **template.aoi** in the directory of your choice and click **OK**.
3. In the Mosaic Tool viewer, select **Edit | Add Images**.

The Add Images for Mosaic dialog opens.

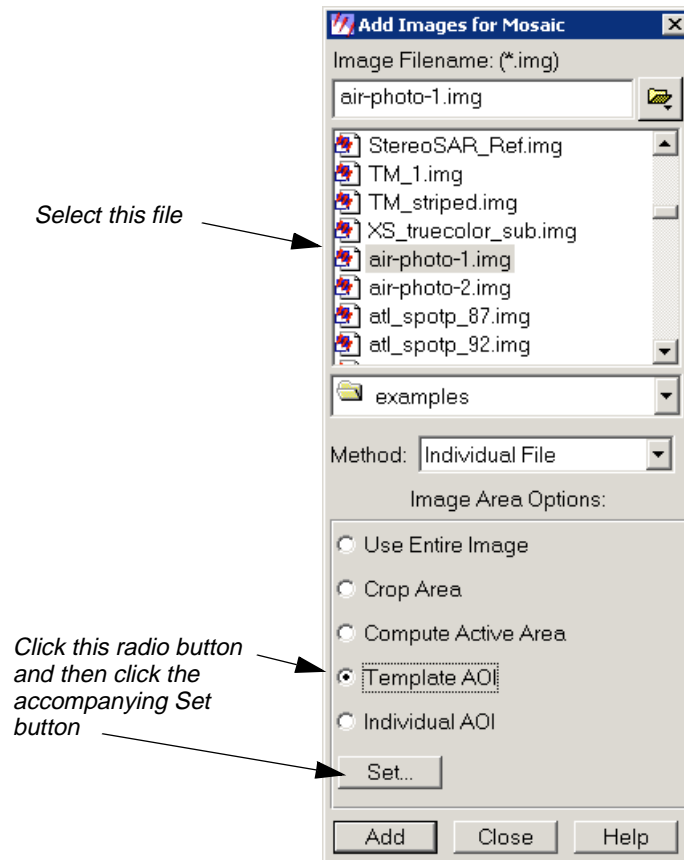

4. Under **Image Filename**, select **air-photo-1.img**.



## Mosaic Using Air Photo Images

- Under **Image Area Options**, click the **Template AOI** button, and then click the accompanying **Set** button.

The Choose AOI dialog opens.

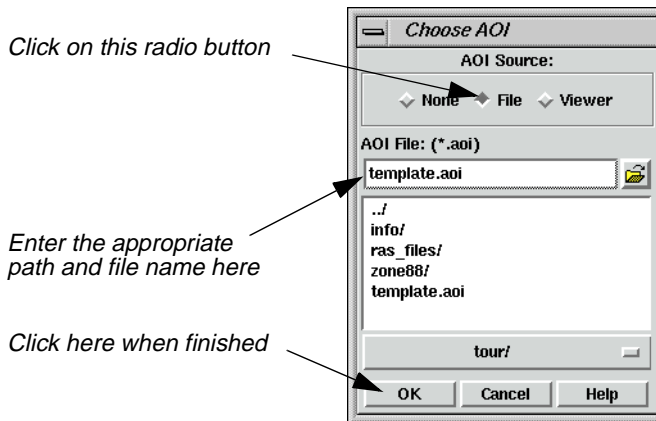

- In the Choose AOI dialog under **AOI Source**, select **File**.
- Under **AOI File**, select **template.aoi** from the directory in which you saved it.
- Click **OK** in the Choose AOI dialog.
- Select **Edit | Image List** from the Mosaic Tool viewer.

The Mosaic Image List displays.



- Click **Add** in the Add Images for Mosaic dialog.

The data for **air-photo-1.img** display in the Mosaic Image List CellArray and a graphic of the image displays on the canvas of the Mosaic Tool viewer.



# Mosaic

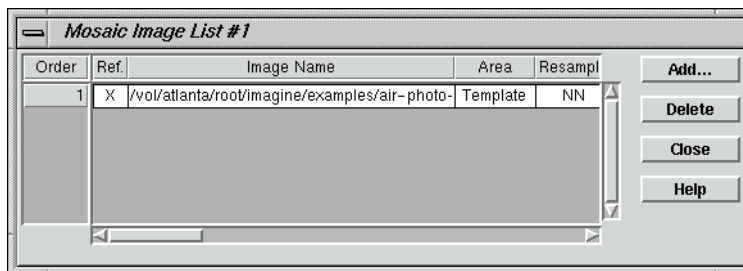

11. In the Add Images for Mosaic dialog under **Image Filename**, select **air-photo-2.img**.
12. Under **Image Area Options**, click the **Compute Active Area** button.
13. Click **Add** and then **Close** in the Add Images for Mosaic dialog.

The data for **air-photo-2.img** display in the Mosaic Image List CellArray, and a graphic of the image displays on top of the **air-photo-2.img** graphic in the canvas of the Mosaic Tool viewer.

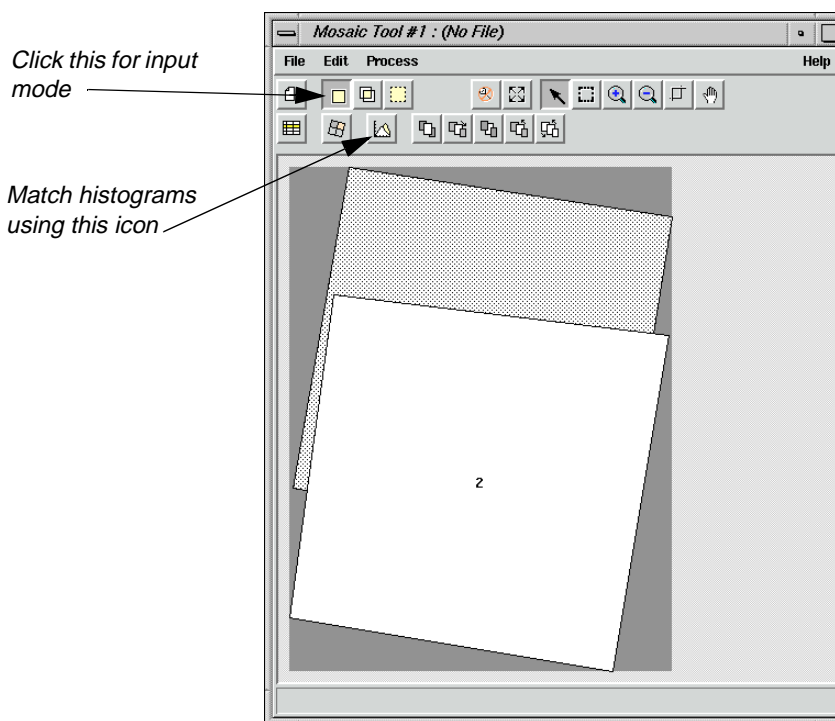

## Identify Areas of Intersection

1. In the Mosaic Tool viewer, click on the Input icon to verify that the input mode is activated.



2. Click on the Image Matching icon.



The Matching Options dialog opens.

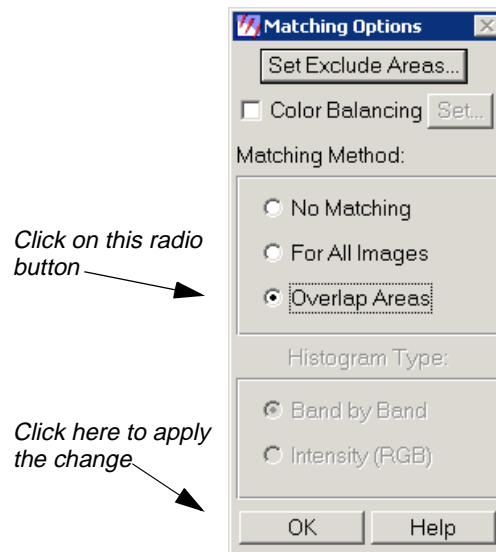

3. In the Matching Options dialog under **Matching Method**, click the **Overlap Areas** button.
4. Click **OK** in the Matching Options dialog.
5. In the Mosaic Tool viewer, click on the Intersection icon to activate the intersect mode.



6. In the canvas of the Mosaic Tool viewer, click on a line that intersects the two images.

The lines that overlap the two images are highlighted in yellow.



# Mosaic

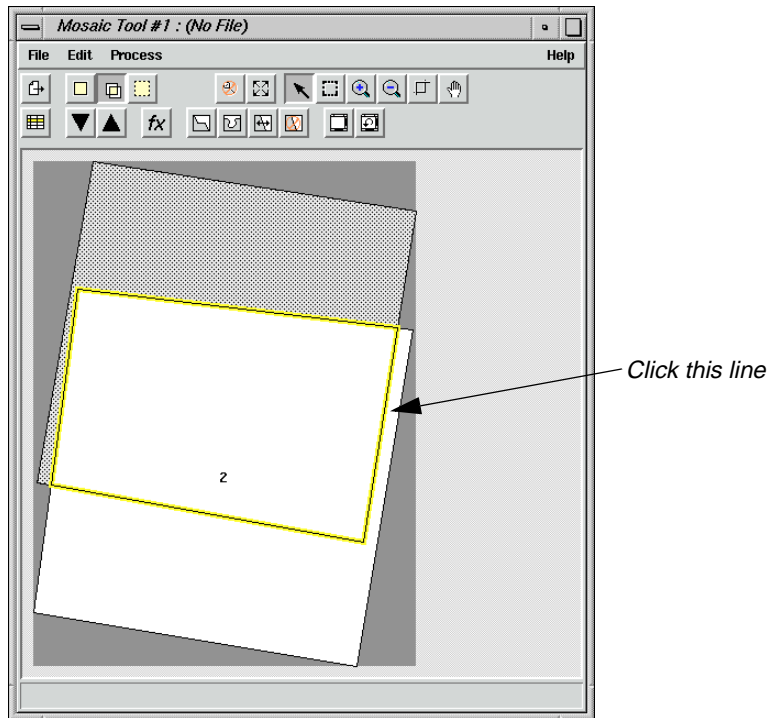

## Draw a Cutline

The Mosaic Tool enables you to draw one cutline through all the images or a single cutline in an individual image.

1. In the Mosaic Tool viewer, click on the Cutline Selection icon.



Viewer #3 opens, displaying the two images as they intersect.

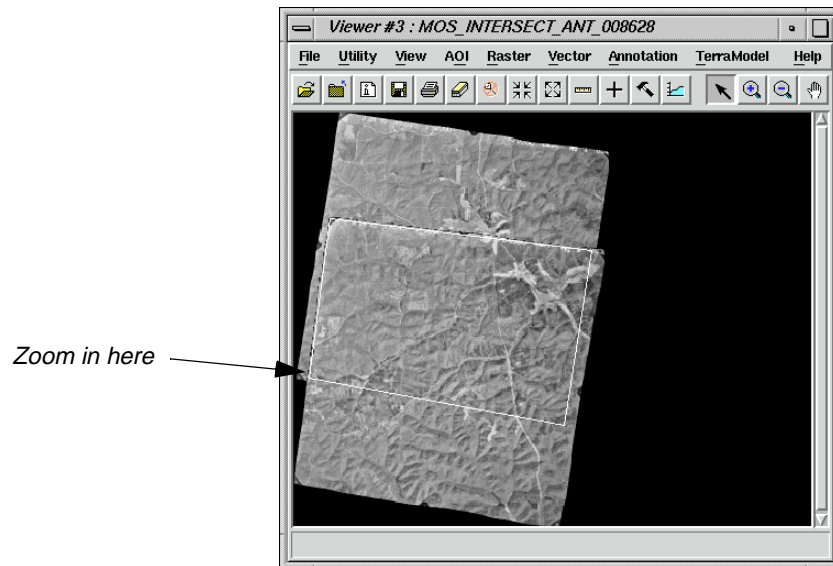

2. Use the Zoom In tool in the Viewer #3 tool bar to zoom in on the spot where you draw your cutline. (Do this by selecting the Zoom In tool and then clicking on the spot for which you want a closer view.)



3. Select the Line tool from the AOI tool palette.



Once in the Viewer, the cursor becomes a crosshair.

4. In Viewer #3, draw the cutline by dragging inside the intersecting portion of the two images (the portion marked by the AOI box) (i.e., on-screen digitize the intersecting portion). Middle-click when finished.

*NOTE: When drawing cutlines, it is best to trace linear landmarks, such as rivers or roads. This conceals any seams in the resulting mosaic.*

*NOTE: If you do not have a three-button mouse, you can double-click to close the polygon.*

5. In the Mosaic Tool viewer, click on the AOI Cutline icon.



The Choose AOI dialog opens.

6. In the Choose AOI dialog under **AOI Source**, select the **Viewer** button and click **OK**.



# Mosaic

7. An Attention dialog opens, warning you that cutlines can be lost if projection is changed. Click **Yes** in the dialog.

The cutline is highlighted in red in the Mosaic Tool viewer canvas.

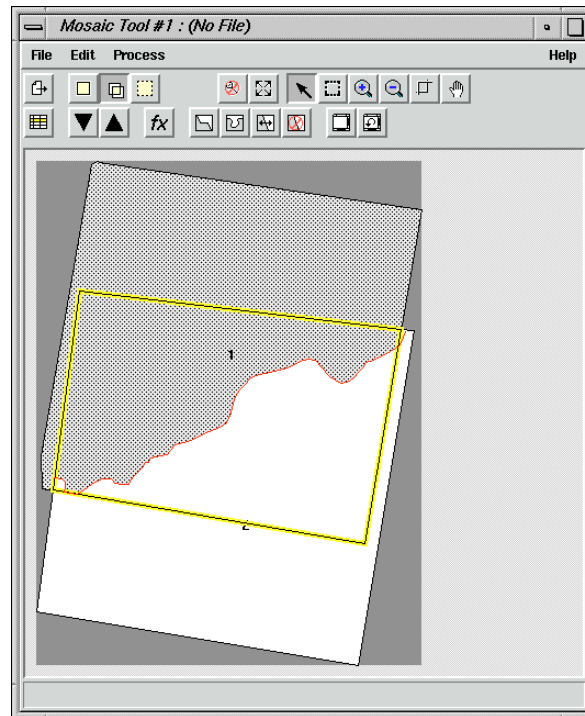

8. Click the Function icon in the Mosaic Tool viewer.



The Set Overlap Function dialog opens.

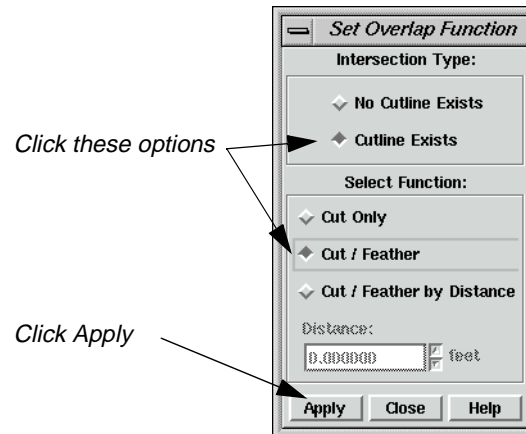

9. In the Set Overlap Function dialog under **Intersection Type**, select **Cutline Exists**.

10. Under **Select Function**, select **Cut/Feather**.

11. In the Set Overlap Function dialog, click **Apply** and then **Close**.

12. *NOTE: The cutline viewer will automatically zoom to whatever is in the mosaic tool. In order to only show the overlapping area in the viewer, you need to click **scale canvas to fit selected objects**.*



## Define Output Images

1. In the Mosaic Tool viewer, click on the Output icon to activate the output mode.



2. In the Mosaic Tool viewer, click on the Output Image icon.



The Output Image Options dialog opens.



# Mosaic

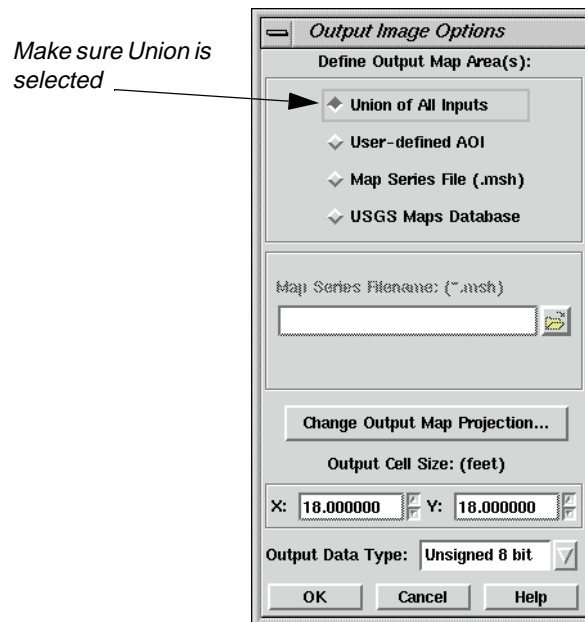

3. In the Output Image Options dialog under **Define Output Map Area(s)**, make sure that **Union of All Inputs** is selected and click **OK**.

## Run the Mosaic

1. In the Mosaic Tool viewer, select **Process | Run Mosaic**.

The Run Mosaic dialog opens.

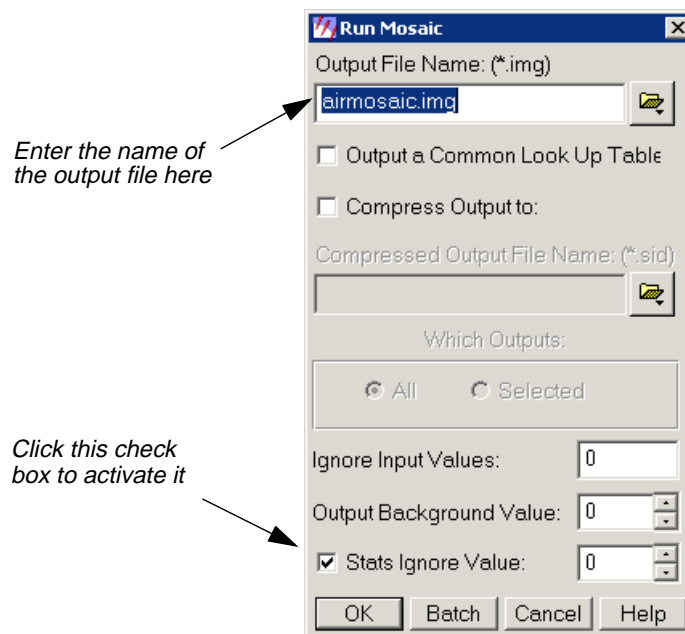



2. In the Run Mosaic dialog under **Output File Name**, enter **AirMosaic** in the directory of your choice, then press Return on your keyboard.
3. Click the **Stats Ignore Value** checkbox to activate it.
4. Click **OK** in the Run Mosaic dialog.  
A Job Status dialog displays, showing the progress of the function.
5. Click **OK** when the Job Status dialog reads that the function is 100% complete.

*NOTE: The Job Status dialog may close automatically, depending on your settings in **Session | Preferences | User Interface & Session | Keep Job Status Box**.*

### Display the Mosaic

1. Click on the Viewer icon in the ERDAS IMAGINE icon panel.  
A new Viewer displays.
2. Click the Open icon in the Viewer you just created.



The Select Layer To Add dialog opens.

3. In the Select Layer To Add dialog under **Filename**, select **AirMosaic.img** from the directory in which you saved it, and then click **OK**.

**AirMosaic.img** is displayed in the Viewer.

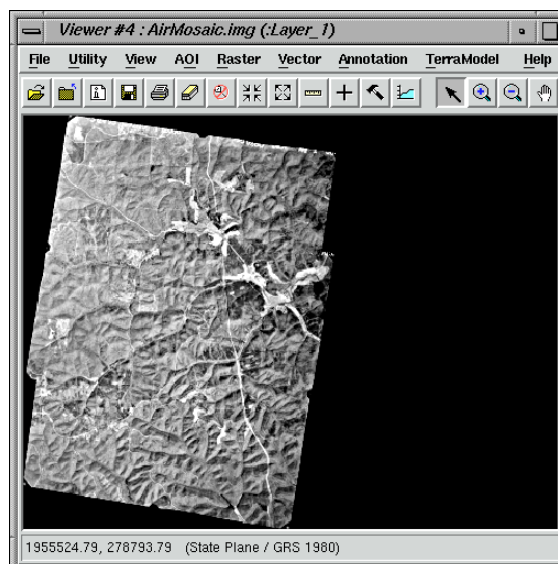

4. Compare **AirMosaic.img** to the original images (**air-photo-1.img** and **air-photo-2.img**).



# Mosaic

## Mosaic Using LANDSAT Images

In this section of the tour guide, you mosaic LANDSAT images of MSS and TM scenes.

The three files to be mosaicked are: **wasia1\_mss.img**, **wasia2\_mss.img**, and **wasia3\_tm.img**.

These data files are LANDSAT images of Kazakhstan, in the former USSR.

Prepare

ERDAS IMAGINE should be running and a Viewer should be open.

## Display Input Images

1. In the Viewer, select **File | Open | Raster Layer** or click the Open icon.



The Select Layer To Add dialog opens.

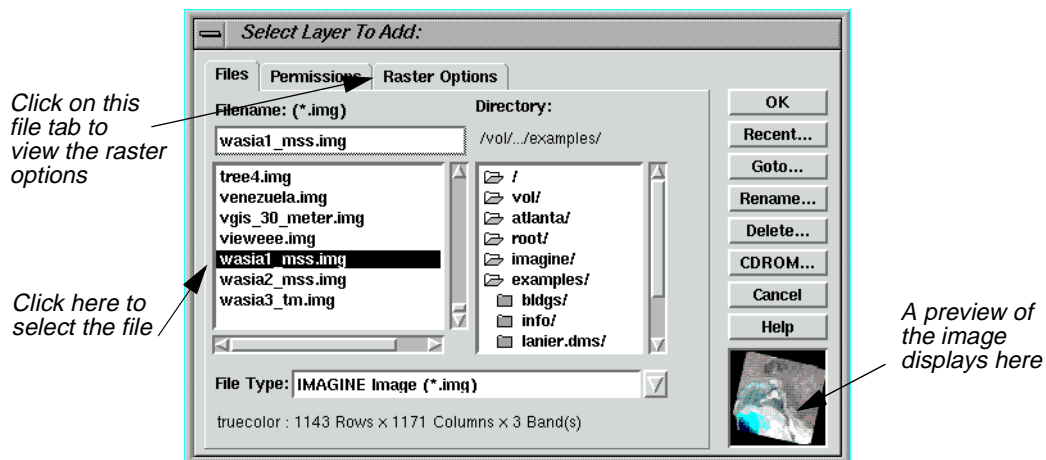

2. In the Select Layer To Add dialog under **Filename**, click on **wasia1\_mss.img**
3. Click the **Raster Options** tab at the top of the Select Layer To Add dialog.
4. Click the **Clear Display** option to disable it (this ensures that currently displayed files are not cleared in the Viewer).
5. Click the **Background Transparent** option to enable it.
6. Check to be sure that the **Fit to Frame** option is enabled.
7. Click **OK** in the Select Layer To Add dialog.

## Mosaic Using LANDSAT Images

The file **wasia1\_mss.img** displays in the Viewer.

8. Repeat steps 1. through 7., opening **wasia2\_mss.img** and **wasia3\_tm.img** in the same Viewer you used for **wasia1\_mss.img**.
9. When finished, you should be able to see all three files in the Viewer:

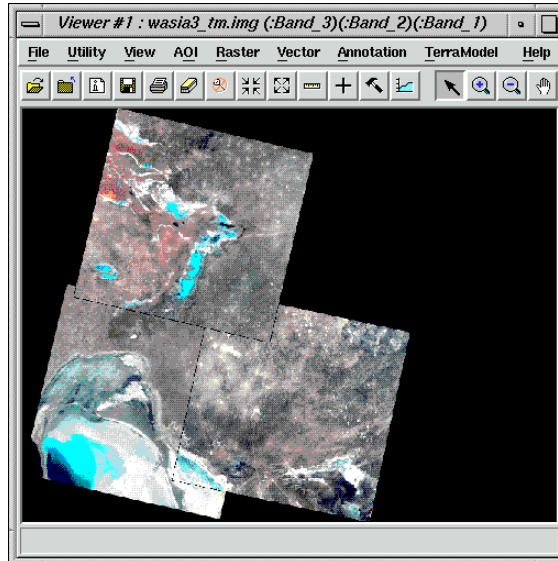

10. In the ERDAS IMAGINE icon panel, click on the DataPrep icon.



The **Data Preparation** menu displays.

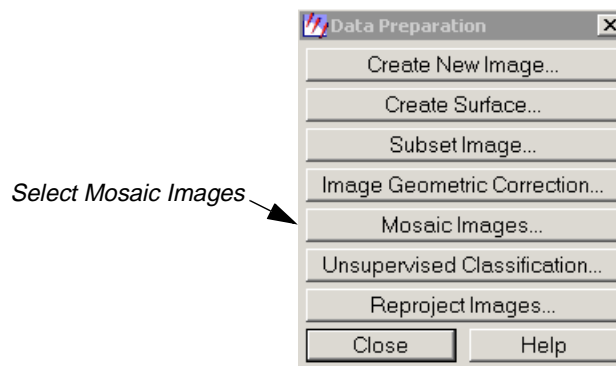

11. In the **Data Preparation** menu, select **Mosaic Images**.



# Mosaic

The Mosaic Tool viewer opens.

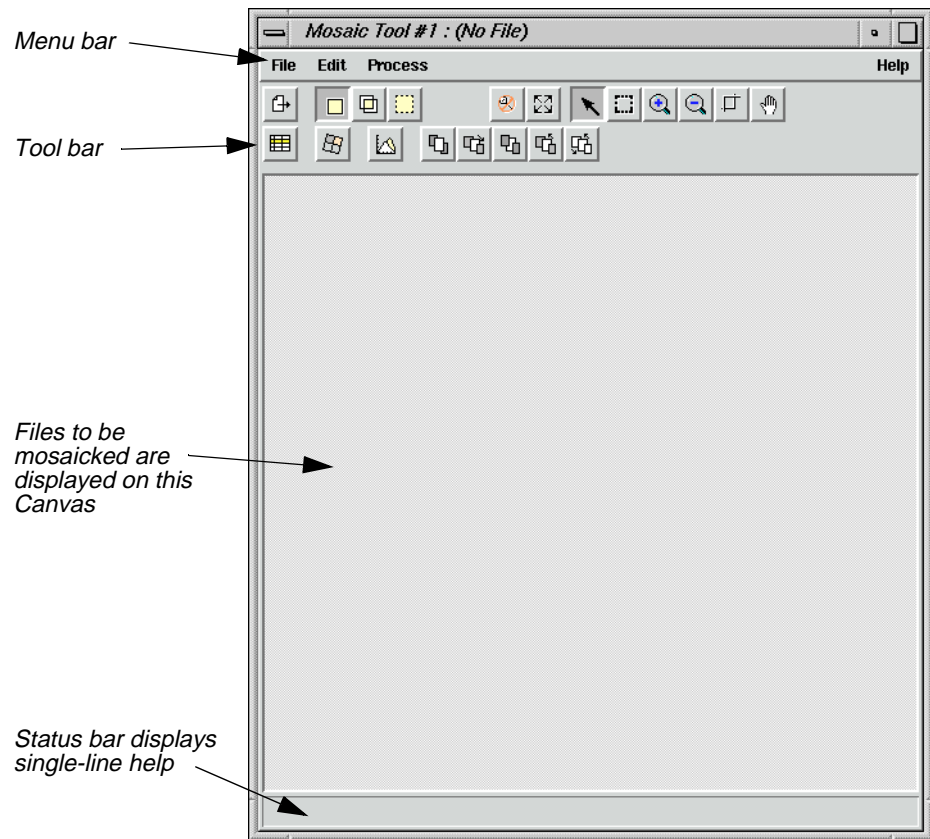

Refer to "Mosaic" on page 620 for a description of the Mosaic Tool menu bar and tool bar.

12. Click **Close** in the **Data Preparation** menu to clear it from the screen.

## Add Images for Mosaic

1. In the Mosaic Tool viewer, click on the Add Images icon.



The Add Images for Mosaic dialog opens.

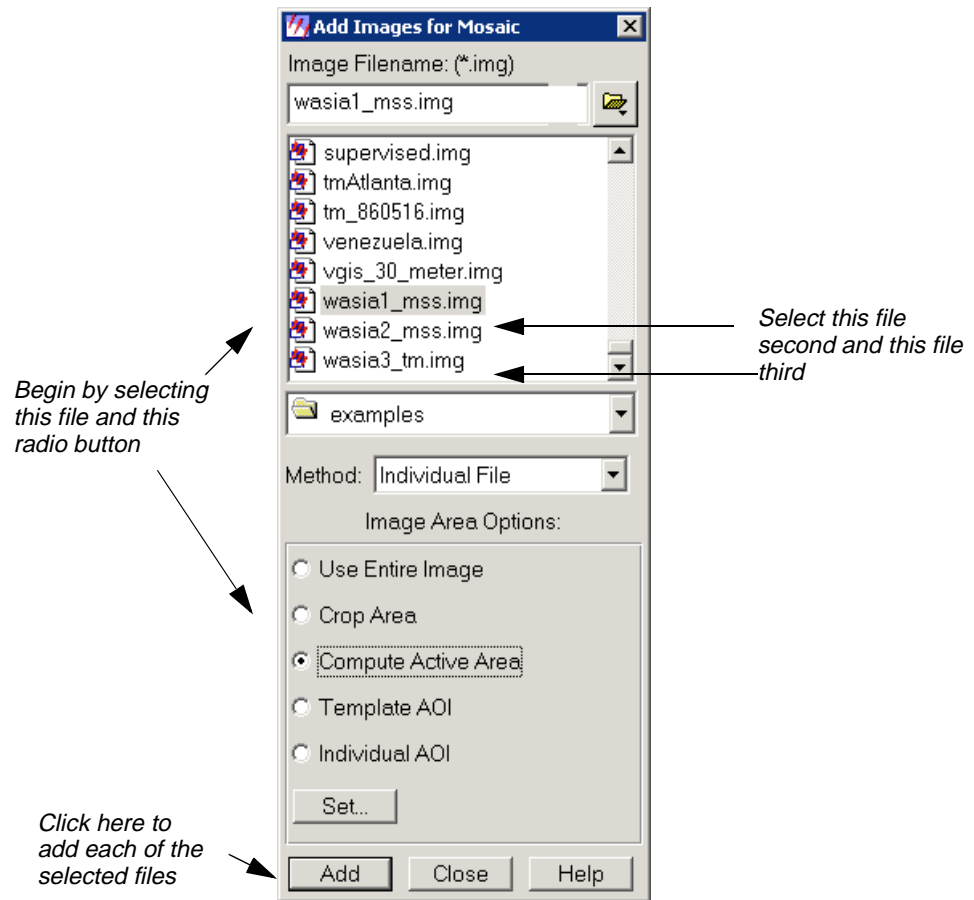

2. In the Add Images for Mosaic dialog under **Image Filename**, select **wasia1\_mss.img**.
3. In the Add Images for Mosaic dialog, click the **Compute Active Area** button under **Image Area Options** to enable it, and then click **Add**.

The file **wasia1\_mss.img** displays as image number **1** in the canvas of the Mosaic Tool viewer.

4. Repeat steps (2. and 3., adding **wasia2\_mss.img** and **wasia3\_tm.img** to the canvas of the Mosaic Tool viewer. (Note that in step 3. the **Compute Active Area** button is already enabled.)

When you are finished adding the three images, the Mosaic Tool viewer should look like the following:



# Mosaic

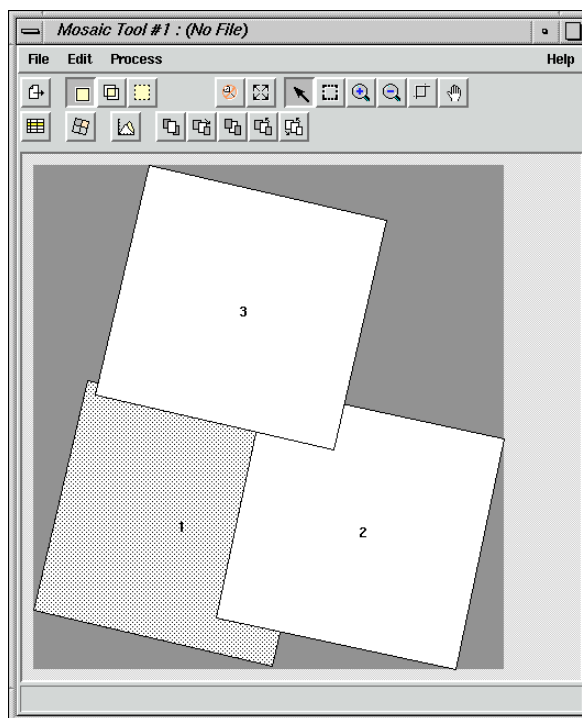

5. Click **Close** in the Add Images for Mosaic dialog.

## Stack Images

The images in the Mosaic Tool viewer are positioned as if they were regular photos that a person stacked by hand. One image intersects everything below it in the stack.

1. Experiment with the stacking order in the Mosaic Tool viewer by clicking on any or all of the images in the canvas and then clicking on any of the icons pictured below:



2. When you are finished experimenting with the stacking icons, click outside of the images in the canvas of the Mosaic Tool viewer to deselect the image(s).

## Match Images

1. Click the Image Matching icon in the Mosaic Tool viewer.



The Matching Options dialog opens.

2. In the Matching Options dialog under **Matching Method**, select **Overlap Areas**.

3. Click **OK** in the Matching Options dialog.
4. Click on the Intersection icon in the Mosaic Tool tool bar.



5. In the Mosaic Tool tool bar, click the Function icon.



The Set Overlap Function dialog opens.

6. In the Set Overlap Function dialog under **Select Function**, select **Average** and then click **Apply**.
7. Click **Close** in the Set Overlap Function dialog.

### Run the Mosaic

1. In the Mosaic Tool viewer, select **Process | Run Mosaic**.

The Run Mosaic dialog opens.

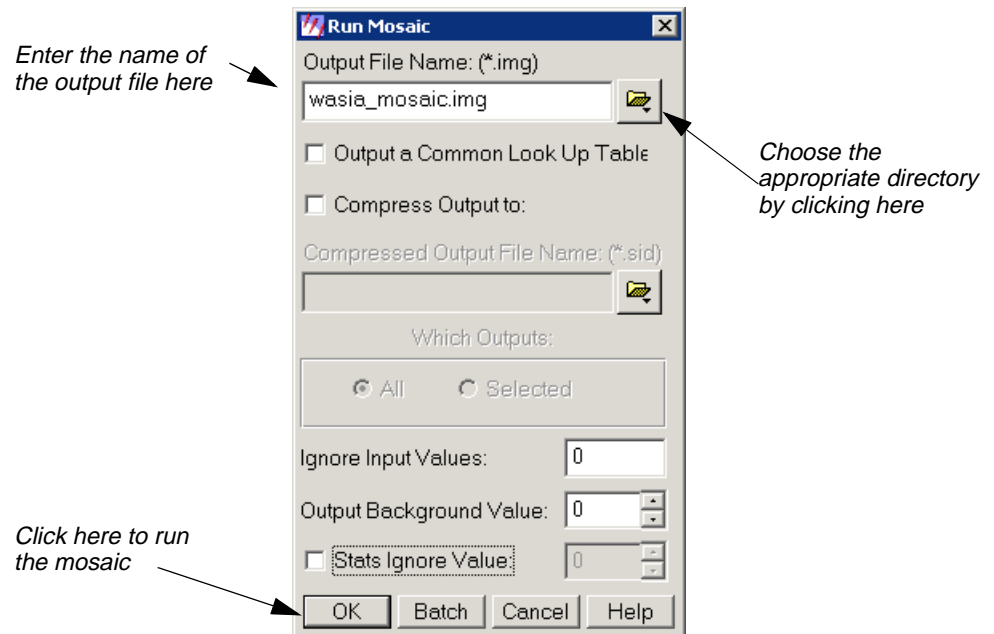

2. In the Run Mosaic dialog under **Output File Name**, enter a name for the output file in the directory of your choice (e.g., **wasia\_mosaic.img**).



## Mosaic

3. Click **OK** in the Run Mosaic dialog.

A Job Status dialog displays, stating the progress of the mosaic operation.

4. Click **OK** in the Job Status dialog when the mosaic operation is finished.

*NOTE: The mosaic operation can take up to ten minutes to run, based upon your hardware capabilities and the size of the files.*

5. Select **File | Close** from the Mosaic Tool viewer to clear it from the screen.

You are asked if you want to save the changes in the Mosaic Tool viewer. Save them if you like or click **No** to dismiss the dialog.

## Display Output Image

1. Click the Viewer icon in the ERDAS IMAGINE icon panel to open a second Viewer.



2. In the Viewer you just opened, select **File | Open | Raster** or click the Open icon.



The Select Layer To Add dialog opens.

3. In the Select Layer To Add dialog under **Filename**, click on the file **wasia\_mosaic.img** (or the output mosaic image you previously created). Remember to look in the directory in which you saved the file.
4. Click the **Raster Options** tab at the top of the Select Layer To Add dialog.
5. Check to be sure that the **Fit to Frame** option is enabled.
6. Click **OK** in the Select Layer To Add dialog.

The output mosaic file displays in the Viewer.



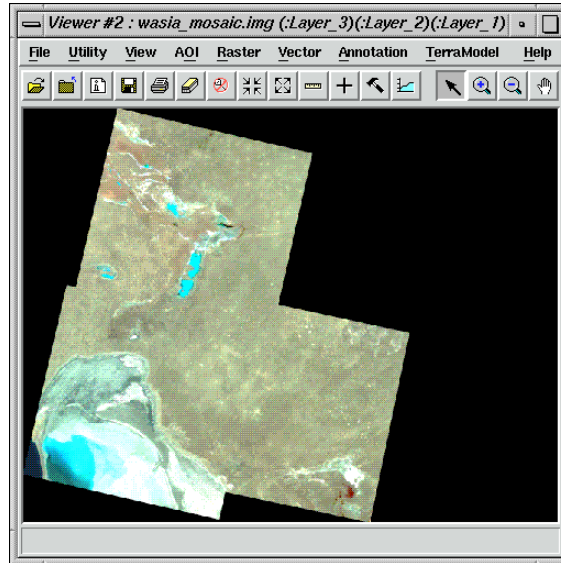

7. In the ERDAS IMAGINE menu bar, select **Session | Tile Viewers** to position the Viewers side by side.
8. Compare the input mosaic images in the first Viewer to the output mosaic image in the second Viewer. You can resize the Viewers by dragging on any of their corners.

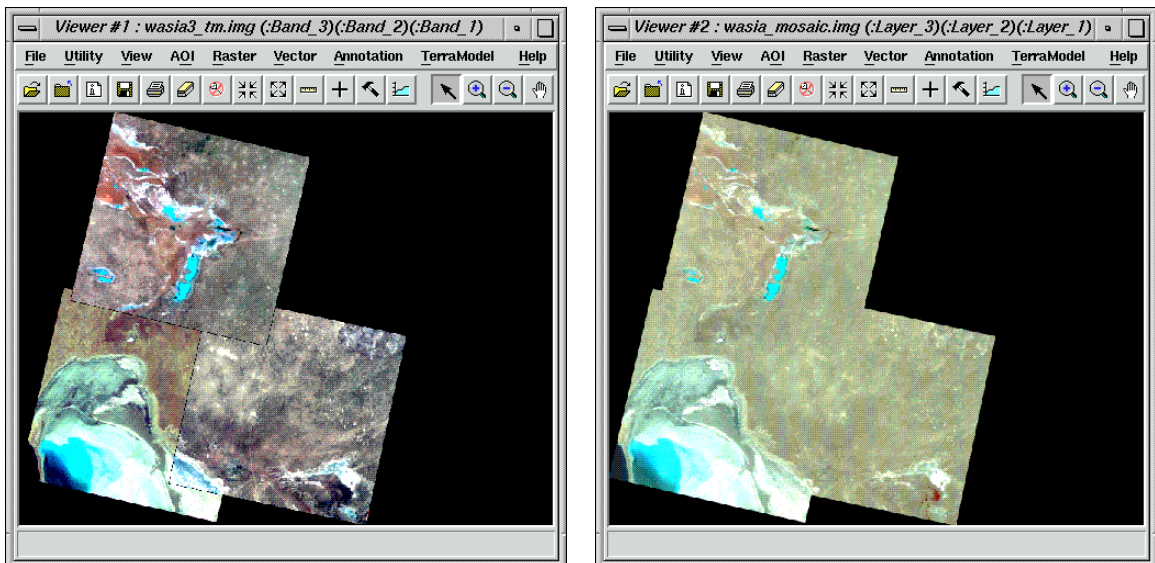

For more information about Mosaic, see "APPENDIX A: Additional Information" on page 595.



# Mosaic

## Mosaic Color Balancing Using Color Infrared Aerial Photos

In this section of the tour guide, you mosaic color- infrared aerial photograph images of eastern Illinois, USA. The color red in the photos represents vegetation with deep reds representing healthy vegetation.

The nine files to be mosaicked are: **2-2.img, 2-3.img, 2-4.img, 3-2.img, 3-3.img, 3-4.img, 4-2.img, 4-3.img, and 4-4.img.**



*For UNIX only! The nine files you need to use are located on the Data and Documentation CD-ROM that was shipped with IMAGINE 8.5. Before beginning this tour, you will need to copy these files from the examples folder on the Data and Documentation CD-ROM to IMAGINE\_HOME/examples.*

### Prepare

ERDAS IMAGINE should be running and a Viewer should be open.

1. In the Viewer, select **File | Open | Raster Layer** or click the Open icon.



The Select Layer To Add dialog opens.

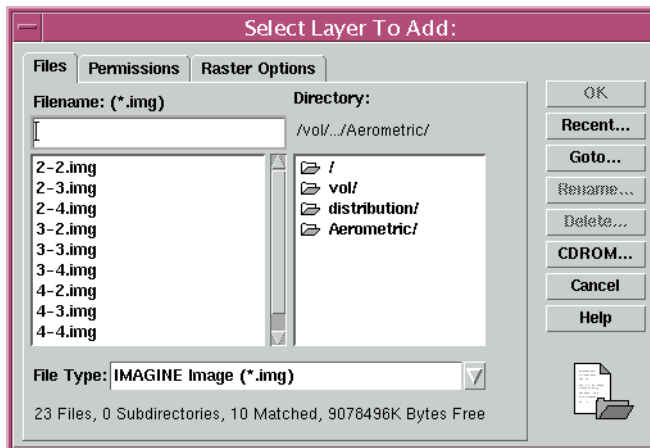

2. In the Select Layer To Add dialog under **Filename**, click on **2-2.img**.
3. Click the **Raster Options** tab at the top of the Select Layer To Add dialog.
4. In the **Layers to Colors** box make sure **Red is 1; Green is 2; and Blue is 3**.
5. Click the **Clear Display** option to disable it (this ensures that currently displayed files are not cleared in the Viewer).
6. Click the **Fit to Frame** option to enable it.

## Mosaic Color Balancing Using Color Infrared Aerial Photos

7. Click the **Background Transparent** option to enable it.
8. Click **OK** in the Select Layer To Add dialog.

The file **2-2.img** displays in the Viewer.

9. Repeat steps 1. through 8., opening **2-3.img**, **2-4.img**, **3-2.img**, **3-3.img**, **3-4.img**, **4-2.img**, **4-3.img**, and **4-4.img** in the same Viewer you used for **2-2.img**.

When finished, you should be able to see all nine files in the Viewer.

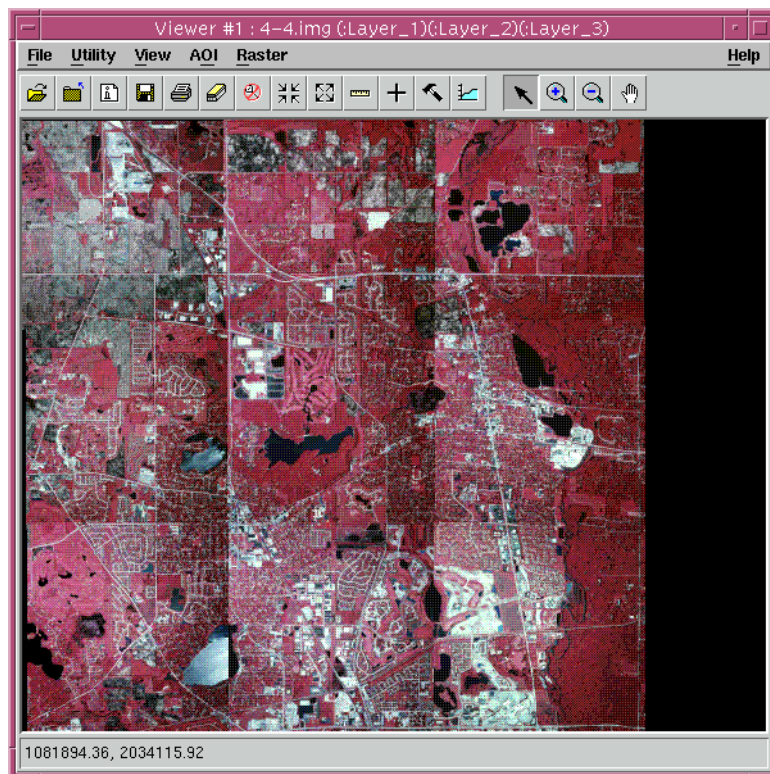

You will see patterned color differences in some of the images. Some spots in some of the photos will appear brighter or darker than the rest of the image. In order to adjust these color differences, you will use the **Mosaic Color Balancing** option in the **Mosaic Tool**.

10. In the ERDAS IMAGINE icon panel, click on the **DataPrep** icon.



The **Data Preparation** menu displays.



# Mosaic

The Mosaic Tool viewer opens.

12. Click **Close** in the **Data Preparation** menu to clear it from the screen.

## Add Images for Mosaic

1. In the Mosaic Tool viewer, click on the Add Images icon.



The Add Images for Mosaic dialog opens.

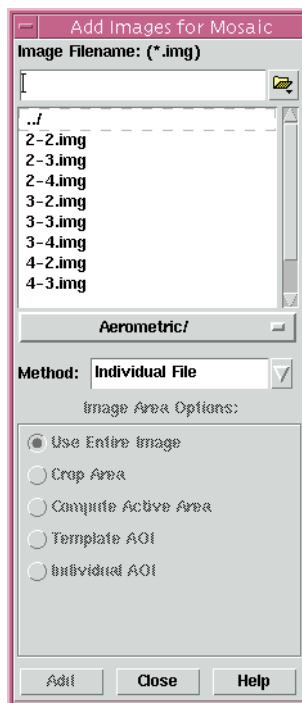

2. In the Add Images for Mosaic dialog under **Image Filename**, select **2-2.img**.
3. In the Add Images for Mosaic dialog, make sure the **Use Entire Image** button is selected, and then click **Add**.

The file **2-2.img** displays as image number **1** in the canvas of the Mosaic Tool viewer.

4. Repeat steps 2. and 3., adding **2-3.img**, **2-4.img**, **3-2.img**, **3-3.img**, **3-4.img**, **4-2.img**, **4-3.img**, and **4-4.img** to the canvas of the Mosaic Tool viewer.

When you are finished adding the nine images, the Mosaic Tool viewer should look like the following:

# Mosaic Color Balancing Using Color Infrared Aerial Photos

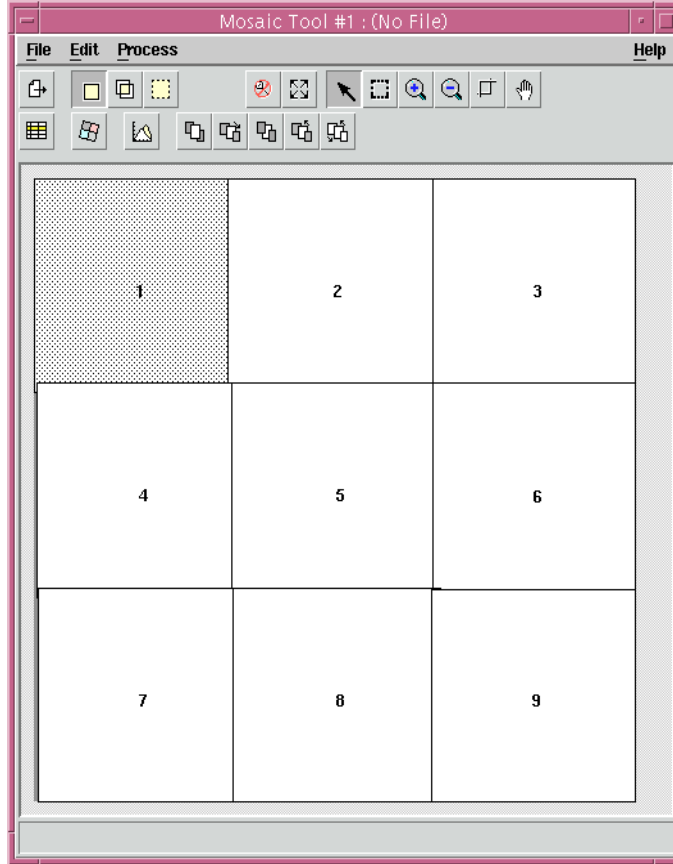

5. Click **Close** in the Add Images for Mosaic dialog.

## Set Exclude Areas

1. Click the Image Matching icon in the Mosaic Tool viewer.



The Matching Options dialog opens.

# Mosaic



2. Select **Color Balancing**, and under **Matching Method** choose **For All Images**.
3. Click on **Set Exclude Areas** at the top of the Matching Options dialog.

The Set Exclude Areas dialog opens.

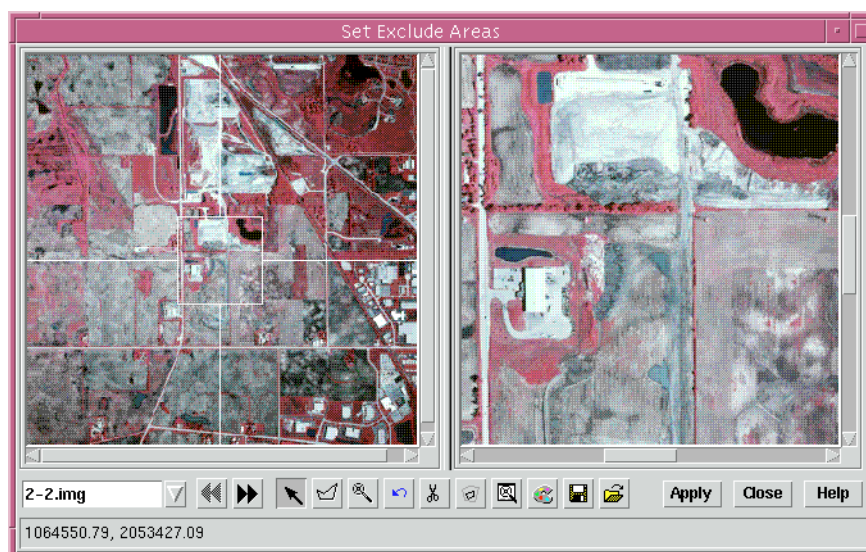

The overview shows the full extent of the image, and the detail view allows you to zoom in on specific areas to create AOIs to be excluded from the Color Balancing process. Use the link cursor to isolate AOIs.

4. Image **2-2.img** will be the first image displayed in the viewers. Left hold your mouse and drag the link cursor to the dark body of water in the upper left of the center of the image.

## Mosaic Color Balancing Using Color Infrared Aerial Photos

In the **Detail View**, the area is magnified so you can create specific AOIs to exclude from the Color Balancing process.

5. Click Create Polygon AOI.



6. Your cursor becomes a cross hair when inside a view. Use the **Detail View** to create polygons around the dark water bodies.

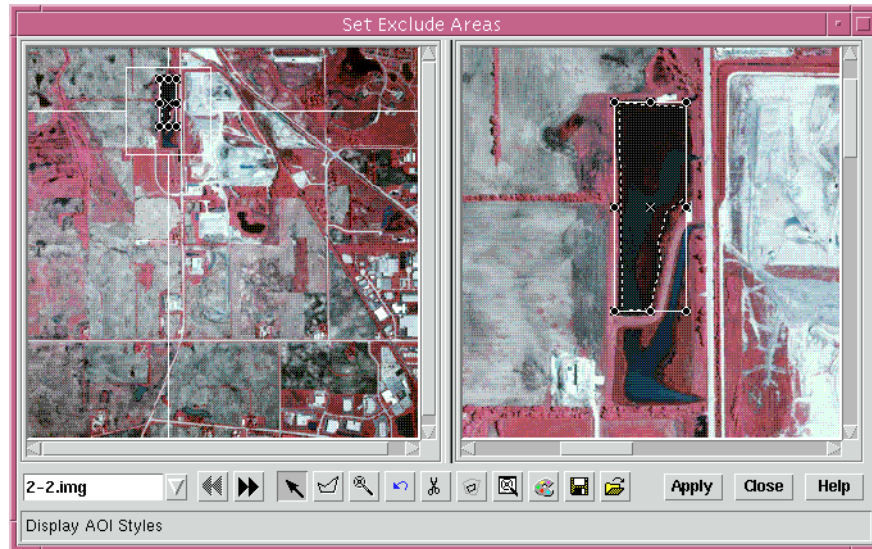

7. When you have finished, use the link cursor to identify any other areas in the image that need to be excluded such as other dark bodies of water, isolated bright urban areas, or bright areas of sun glint.
8. Create a polygon around each of the areas you wish to exclude from color balancing, and click **Apply**.
9. Use the arrow keys or the drop down box to select the next image, **2-3.img**

Continue identifying AOIs to exclude through all nine images. Click **Apply** after excluding areas in each image. Click **Close** in the Set Exclude Areas dialog when finished.

### Mosaic Color Balancing

1. Click the **Set** button in the Matching Options dialog.  
The **Set Color Balancing Method** dialog opens.



# Mosaic

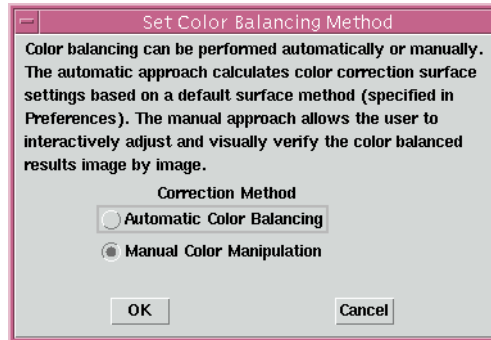

2. Choose **Manual Color Manipulation** and click **OK**.

The **Mosaic Color Balancing** dialog opens.

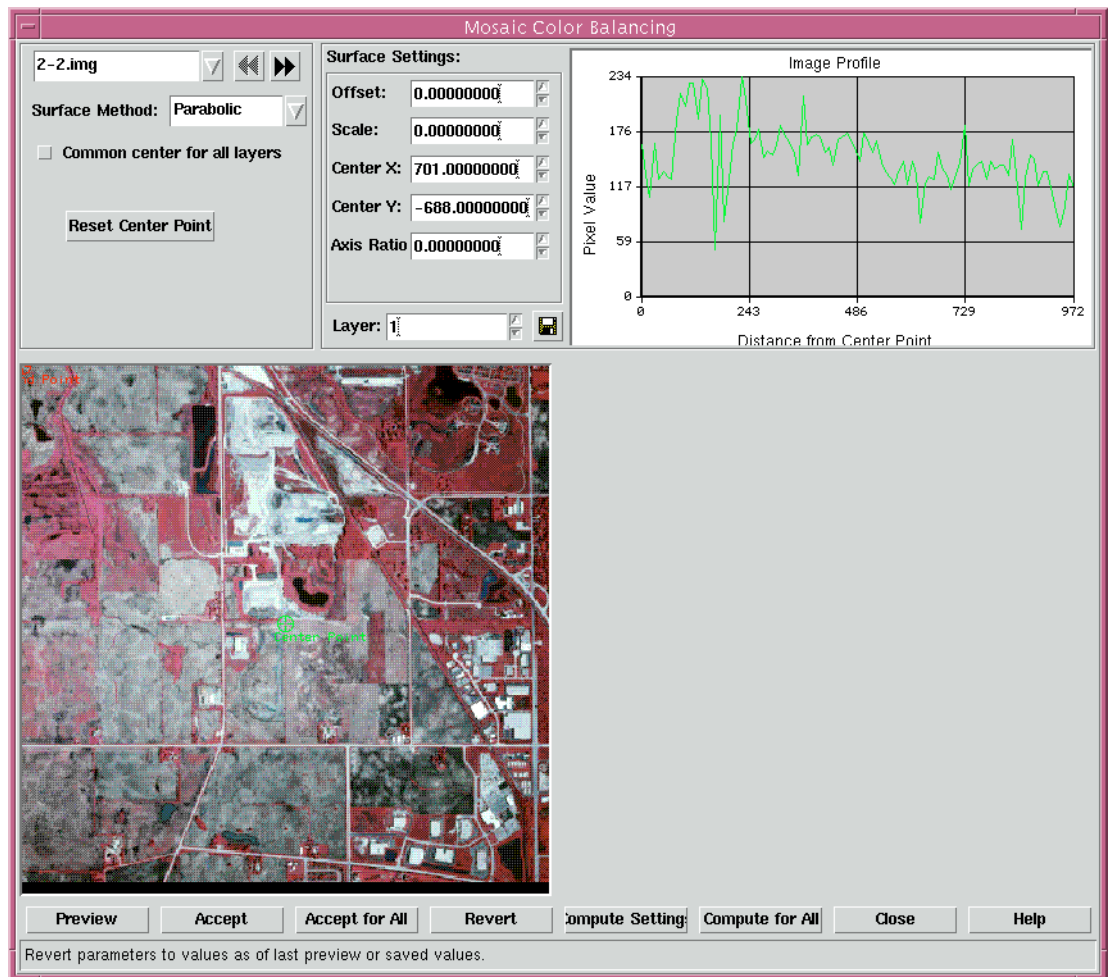



## Mosaic Color Balancing Using Color Infrared Aerial Photos

3. The first image, **2-2.img**, is displayed. If **2-2.img** did not need color balancing, you could skip it, and use the **Arrow Keys** or the **Drop Down Menu** in the top left corner to choose another image.
4. Choose the surface method you want to use in order to color balance the image. You may choose from **Parabolic**, **Conic**, **Linear**, or **Exponential**.

Unless you are using **Linear** as your surface method, you can click on **Common center for all layers** in order to use the same center point in each layer of the image.

5. For image **2-2.img**, select **Conic**, and enable **Common center for all layers**.
6. Click **Compute Setting** and click on **Preview**. The preview viewer displays the color balanced image.
7. Click **Accept** after previewing the color balanced image to accept it for mosaicking.

The computed settings are based on the surface method chosen. The **Image Profile** box at the top right of the **Mosaic Color Balancing** dialog depicts the chosen surface method as a red line plotted against a profile of the pixel values shown as a green line between the center point and end point in the image. Results are best when the red line of the surface method matches the general trend of the green line of the image profile.

8. Repeat steps 3. through 6. for images **2-3.img**, **2-4.img**, **3-2.img**, **3-3.img**, **3-4.img**, **4-2.img**, **4-3.img**, and **4-4.img**.
9. Click **Close** in the Mosaic Color Balancing dialog.

### Match Images

1. Click the Image Matching icon in the Mosaic Tool viewer.



The Matching Options dialog opens.

2. In the Matching Options dialog under **Matching Method**, select **For All Images**
3. Select **Band by Band** under Histogram Type.
4. Click **OK** in the Matching Options dialog.
5. Click on the Intersection icon in the Mosaic Tool tool bar.



6. Click on the Set Default Outlines icon.



# Mosaic



An attention box will appear. Click yes and continue.

7. In the Mosaic Tool tool bar, click the Function icon.



The Set Overlap Function dialog opens.

8. In the Set Overlap Function dialog under **Intersection Type**, select **Cutline Exists** and **Cut/Feather** then click **Apply**.
9. Click **Close** in the Set Overlap Function dialog.

## Run The Mosaic

1. In the Mosaic Tool viewer, select **Process | Run Mosaic**.

The Run Mosaic dialog opens.

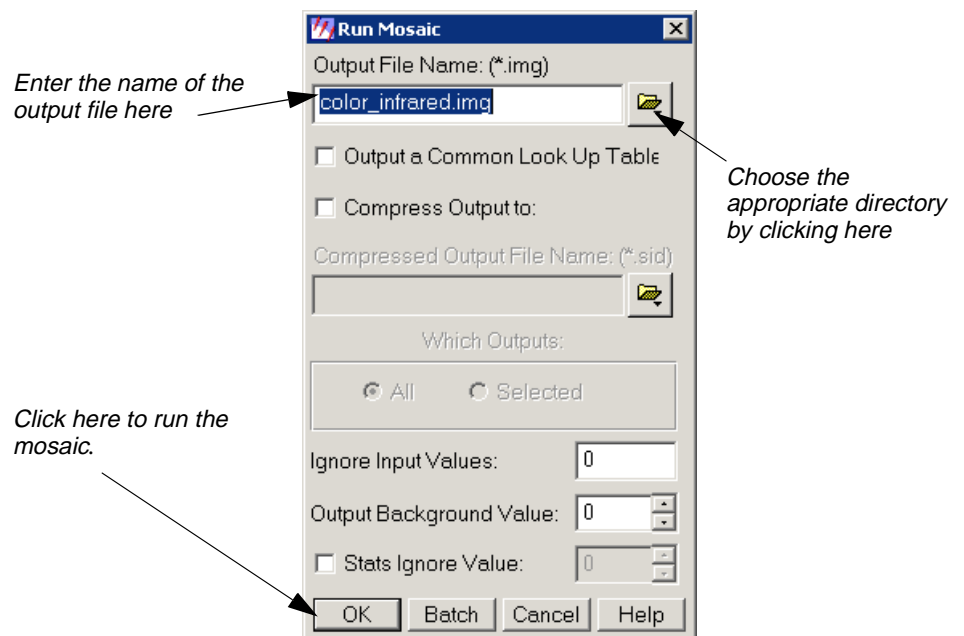

## Mosaic Color Balancing Using Color Infrared Aerial Photos

2. In the Run Mosaic dialog under **Output File Name**, enter a name for the output file in the directory of your choice (e.g., **color\_infrared.img**).

3. Click **OK** in the Run Mosaic dialog.

A Job Status dialog displays, stating the progress of the mosaic operation.

4. Click **OK** in the Job Status dialog when the mosaic operation is finished.

*NOTE: The mosaic operation can take up to ten minutes to run, based upon your hardware capabilities and the size of the files.*

5. Select **File | Close** from the Mosaic Tool viewer to clear it from the screen.

### Display Output Image

1. Click on the Viewer icon in the ERDAS IMAGINE icon panel.

A new Viewer displays.

2. Click the Open icon in the Viewer you just created.



The Select Layer To Add dialog opens.

3. In the Select Layer To Add dialog under **Filename**, select **color\_infrared.img** from the directory in which you saved it, and then click **OK**.
4. Click the **Raster Options** tab at the top of the Select Layer To Add dialog.
5. Check to be sure the **Fit to Frame** option is enabled.
6. Click **OK** in the Select Layer To Add dialog.



# Mosaic

The mosaicked output image displays in the viewer.

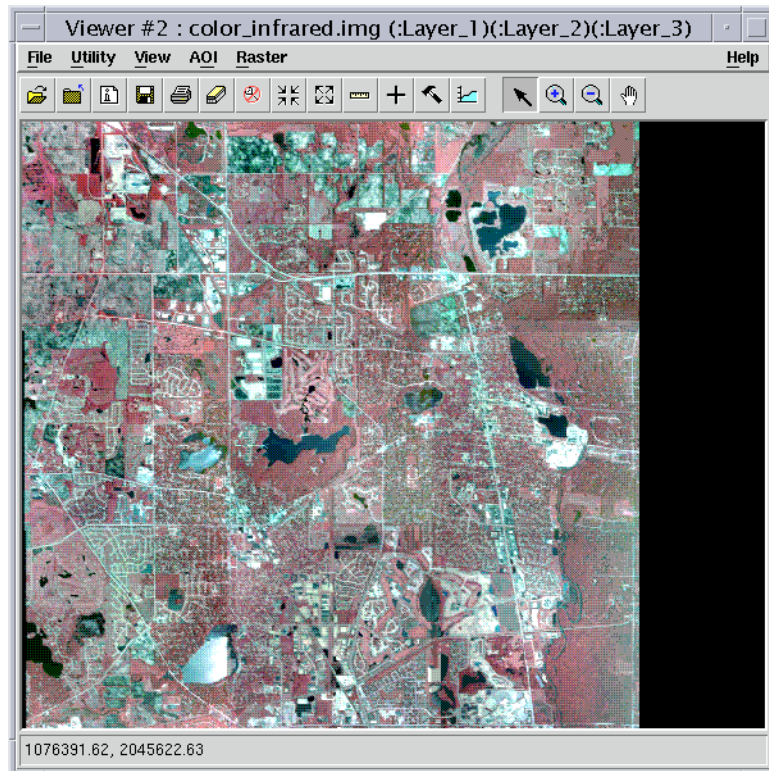

# CHAPTER 15

## Viewshed Analysis

---

### Introduction

One of the many tasks you can perform using IMAGINE Advantage is Viewshed Analysis. This tour guide describes how to use this analysis tool.

Viewshed Analysis allows you to position an observer on a DEM in a Viewer and determine the visible areas within the terrain. You can adjust the observer's height either above ground level or above sea level and set the visible range.

This tool is useful for planning the location and height of towers used for observation or communications. It might also be used to determine areas that lie within poor reception of standard broadcast towers and are thus potential cable markets.

In this tour guide, you can learn how to:

- start an Image Drape viewer
- start the Viewshed tool
- work with multiple observers
- query Viewshed data and layers



---

*Approximate completion time for this tour guide is 15 minutes.*

---

### Create a Viewshed

In this exercise, you create a viewshed, and analyze the terrain within it.

#### Prepare

ERDAS IMAGINE must be running with a Viewer open.

1. Click the Open icon in the Viewer (or select **File | Open | Raster Layer**).



2. In the Select Layer To Add dialog, navigate to the <IMAGINE\_HOME>/examples directory.
3. Select the file **eldodem.img**, then click the **Raster Options** tab.
4. In the **Raster Options** tab, make sure that the **Fit to Frame** checkbox is active.
5. Click **OK** in the Select Layer To Add dialog.

#### Add the Raster Image

1. Click the Open icon again, and navigate to the <IMAGINE\_HOME>/examples directory.



## Viewshed Analysis

2. Select the file **eldoatm.img**, then click the **Raster Options** tab.
3. In the **Raster Options** tab, make sure that the **Clear Display** checkbox is not active.
4. Click **OK** in the Select Layer to Add dialog.

Both files are displayed in the Viewer.

### Start an Image Drape Viewer

1. From the menu bar of the Viewer displaying **eldodem.img**, select **Utility | Image Drape**.

The Image Drape Viewer opens displaying **eldodem.img**, which supplies terrain relief, and **eldoatm.img**, which supplies the color. Position the Image Drape Viewer so that it does not cover the first Viewer you opened. Now, you can set the level of detail.

#### Set the Level of Detail

1. Select **View | LOD Control** from the Image Drape viewer menu bar.

The Level Of Detail dialog opens.

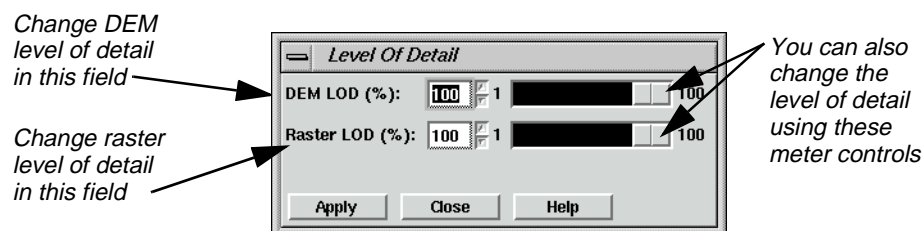

2. In the field next to **DEM LOD (%)**, enter **100**, and press Return on your keyboard.
3. Click **Apply** to increase the level of detail in the Image Drape viewer.
4. Click **Close** to dismiss the Level Of Detail dialog.

Your two Viewers now look like the following:

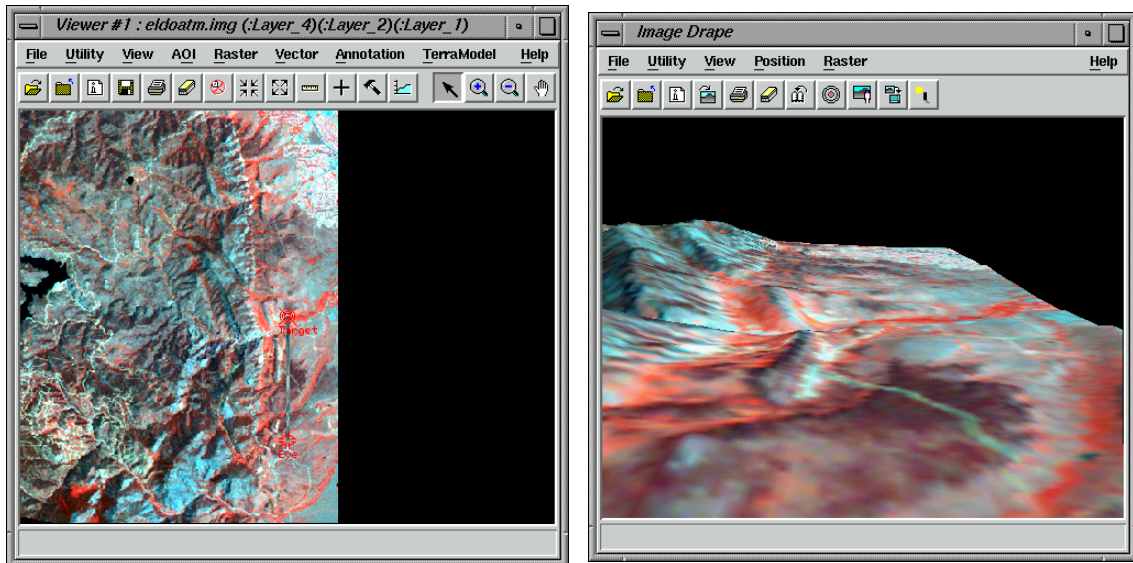

Start the Viewshed Analysis Tool

1. Click the Interpreter icon on the ERDAS IMAGINE icon bar.



The **Image Interpreter** menu opens.

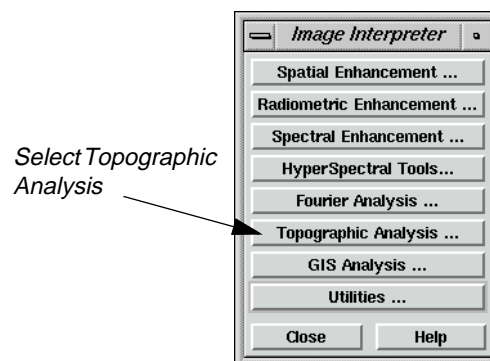

2. From the **Image Interpreter** menu, select **Topographic Analysis**.

The **Topo Analysis** menu opens.

# Viewshed Analysis

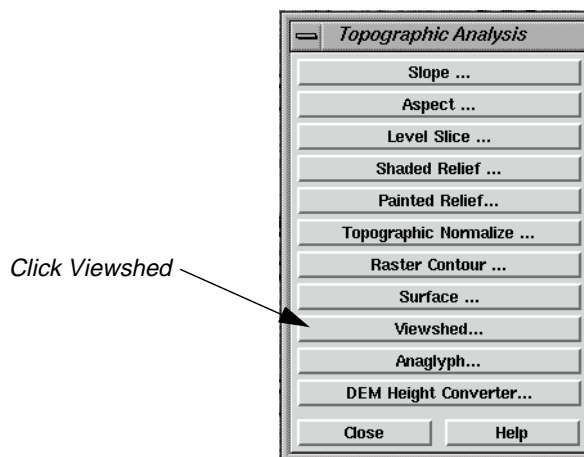

3. From the **Topo Analysis** menu, select **Viewshed**.

A Viewer Selection Instructions dialog opens.

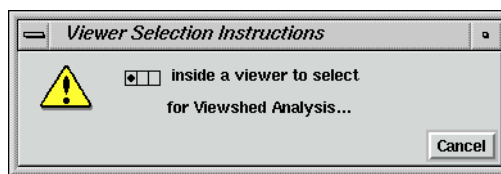

4. Click in the Viewer containing **eldodem.img** and **eldoatm.img**.

The Viewshed dialog opens.

5. At this time, click **Close** on both the **Image Interpreter** menu and the **Topo Analysis** menu to remove them from your display.



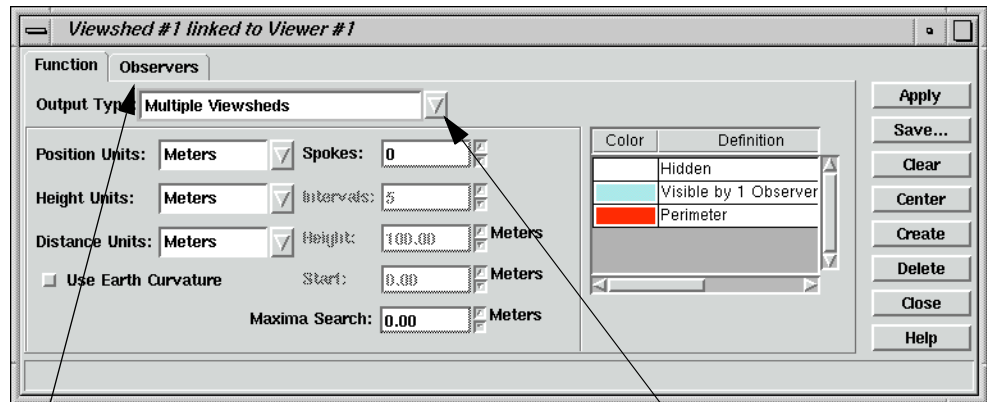

Click the Observers tab to add an observer

Select Multiple Viewsheds

An observer marker is automatically placed in the center of the Viewer containing **eldodem.img**.

6. In the **Function** tab of the Viewshed dialog, click the popup list next to **Output Type** to select **Multiple Viewsheds**.

## Add First Observer

1. Click the **Observers** tab in the Viewshed dialog.

The **Observers** tab of the CellArray displays.

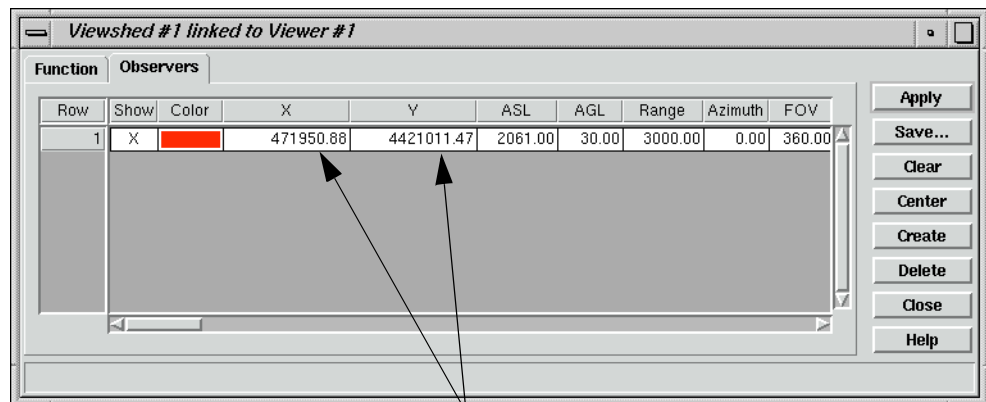

Specify the observer's position in these columns

2. Click in the cell of the **X** column to enter **471950.88**, then press Return on your keyboard.
3. Click in the cell of the **Y** column to enter **4421011.47**, then press Return on your keyboard.
4. Click **Apply** in the Viewshed dialog.

The viewshed layer is generated and displays in the Viewer.



# Viewshed Analysis

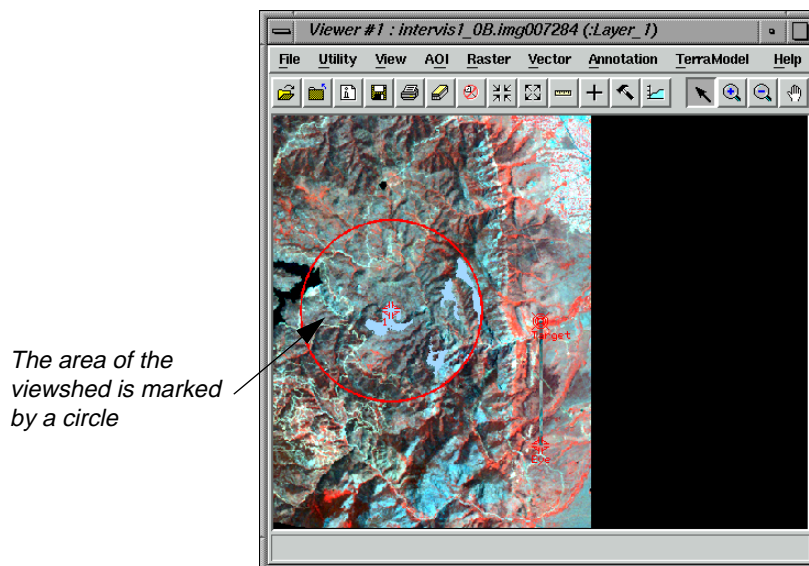

## Add Another Observer

1. Click **Create** in the Viewshed dialog.  
A new observer is added to the CellArray.

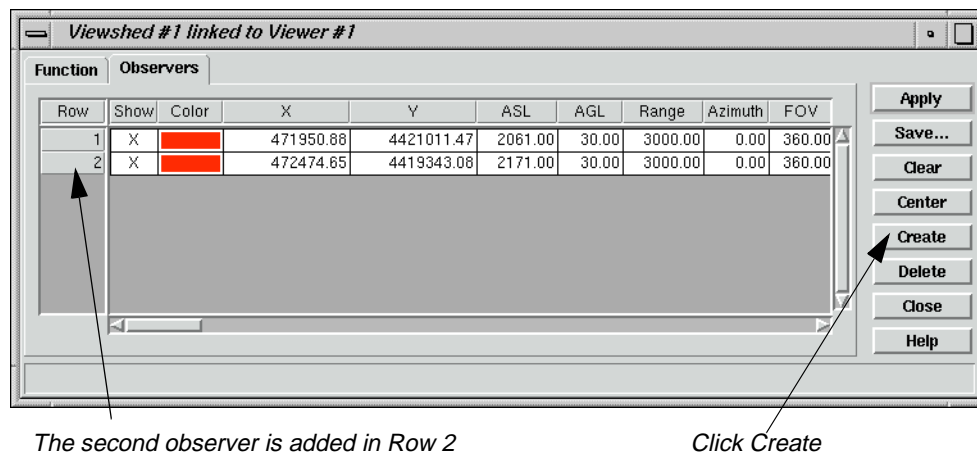

2. Click in the cell of the second observer's **X** column to enter **472474.65**, then press Return on your keyboard.
3. Click in the cell of the second observer's **Y** column to enter **4419343.08**, then press Return on your keyboard.
4. Click **Apply** in the Viewshed dialog.

The second viewshed layer is generated and displays in the Viewer.

Portions of the two viewsheds intersect, evidenced by the overlap of the red circles

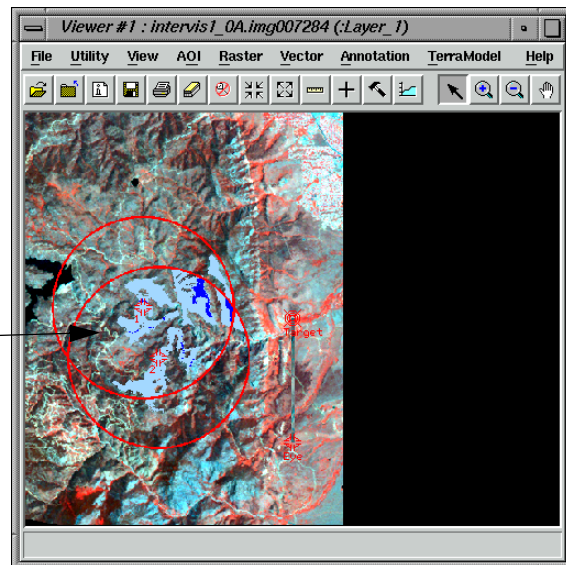

5. Click the **Function** tab in Viewshed dialog to view the legend.

The **Function** tab opens, displaying the legend of the viewshed.

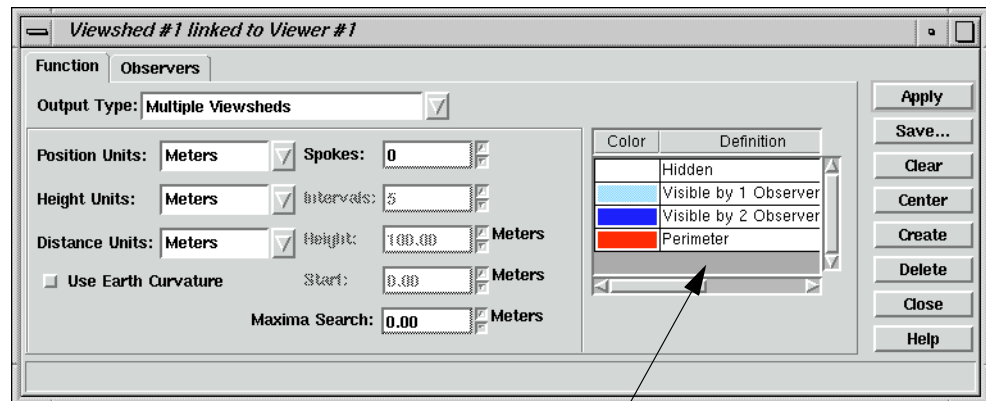

The legend displays here, in the Function tab



There are two basic kinds of output. The Viewshed outputs provide a binary analysis of visibility within the specified range. In other words, the image is color-coded to show only visible or hidden areas. The Height outputs provide a color-coded map of the invisible areas indicating the amount of change in observer height required to see a given zone.



# Viewshed Analysis

## Link the Viewers and Set Eye and Target Positions

1. Using your mouse, move the **Eye** of the Positioning tool on top of **Observer 1**.
2. Move the **Target** on top of **Observer 2** in the Viewer.

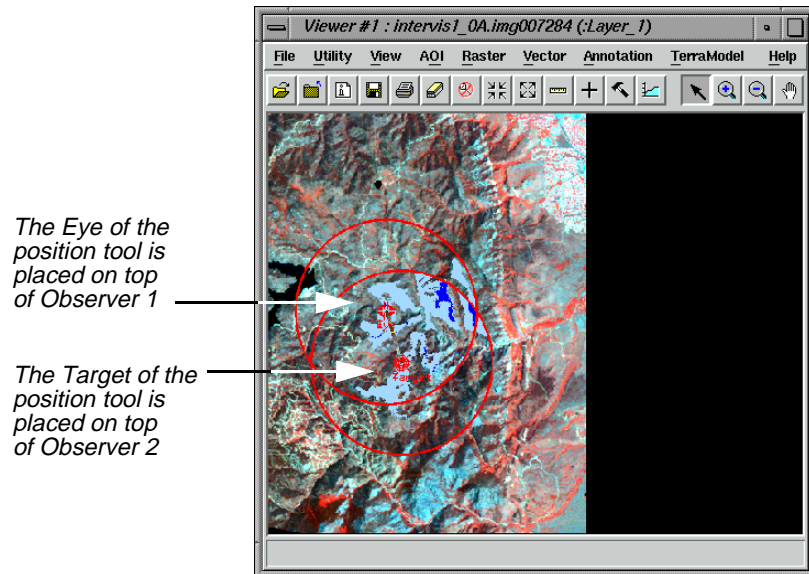

As you move the Positioning tool, the 3D image in the Image Drape viewer is updated. **Observer 1** is now looking at the location of **Observer 2**. The 3D image is positioned so that the target is centered in the Image Drape viewer.

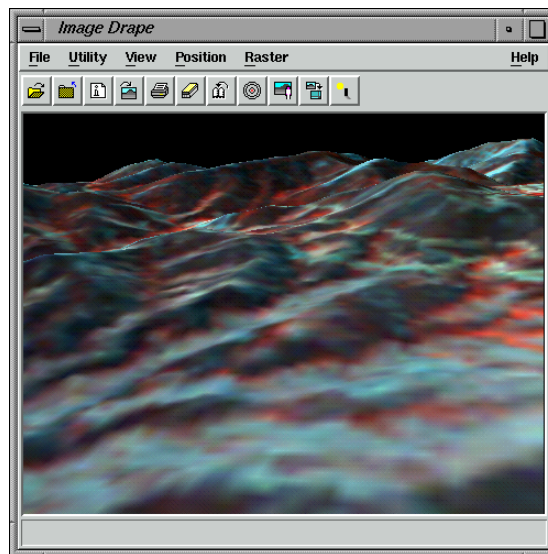

3. Switch the **Eye** and **Target** of the Positioning tool in the Viewer.

**Observer 2** is now looking at the location of **Observer 1**.

Again, the 3D image rotates to match the **Eye** and **Target** positions of the Viewer.

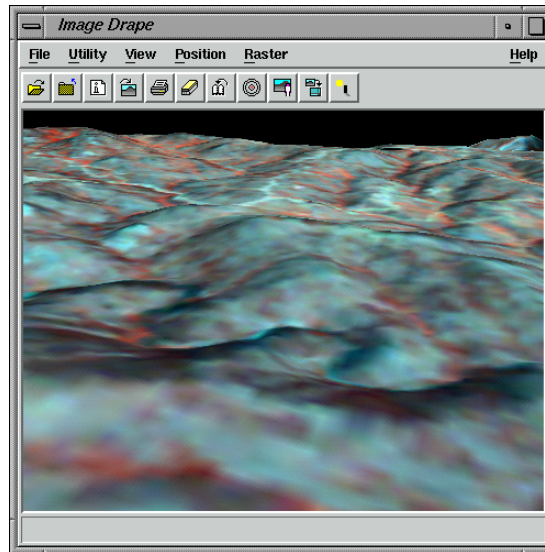

## Save the Viewshed

What can we do with a saved viewshed? For example, the saved viewshed can be used to create a map composition.

1. In the Viewshed dialog, click **Save**.

The Save Viewshed Image dialog opens.

Type the name of the viewshed image here in the directory of your choice

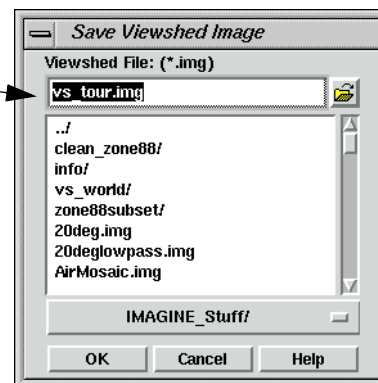

2. In a directory where you have write permission, type **vs\_tour.img** in the **Viewshed File** window.
3. Click **OK** to dismiss the Save Viewshed Image dialog.

A Viewshed Analysis progress meter appears while the image is saved.



## Viewshed Analysis

4. Click **Close** to dismiss the Viewshed dialog.

### Query Viewshed Data

In this section, use the Raster Attribute Editor to query the viewshed layer in the Viewer.

#### Create Class Names for Viewshed Regions

1. Select **Raster | Attributes** from the Viewer menu bar.

The Raster Attribute Editor opens.

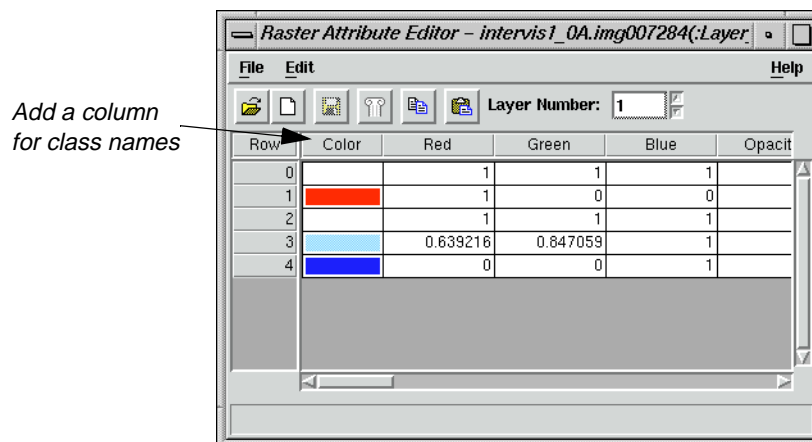

2. Select **Edit | Add Class Names** from the Raster Attribute Editor menu bar.  
A new column is added to the front of the Raster Attributes CellArray.
3. In **Row 1** of the **Class Names** column, enter **Perimeter**, and press Return on your keyboard.
4. In **Row 2**, enter **Hidden Region**, and press Return on your keyboard.
5. In **Row 3**, enter **Visible by One Observer**, and press Return on your keyboard.
6. In **Row 4**, enter **Visible by Two Observers**, and press Return on your keyboard.

*Class Names identify each of the areas in the viewshed*

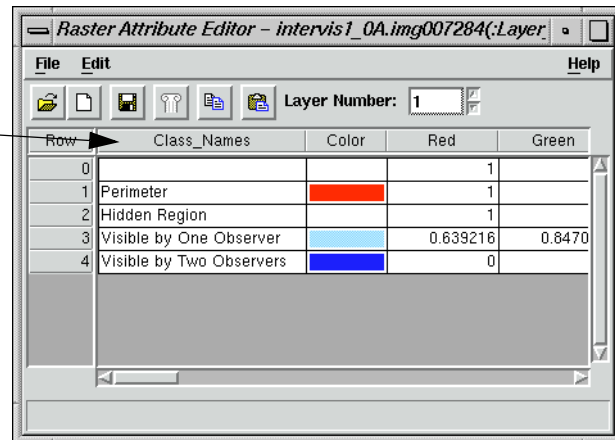

## Add Area Column to the CellArray

1. Now select **Edit | Add Area Column** from the Raster Attribute Editor menu bar.  
The Add Area Column dialog opens.

*Click OK to accept hectares*

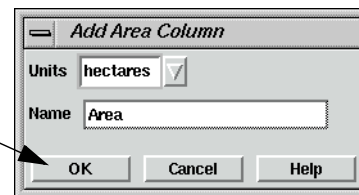

2. Select **acres** from the **Units** popup list and click **OK** to dismiss the Add Area Column dialog.  
The **Area** column is added to end of the Raster Attributes CellArray.
3. Select **Edit | Column Properties** from the Raster Attribute Editor menu bar.  
The Column Properties dialog opens.



## Viewshed Analysis

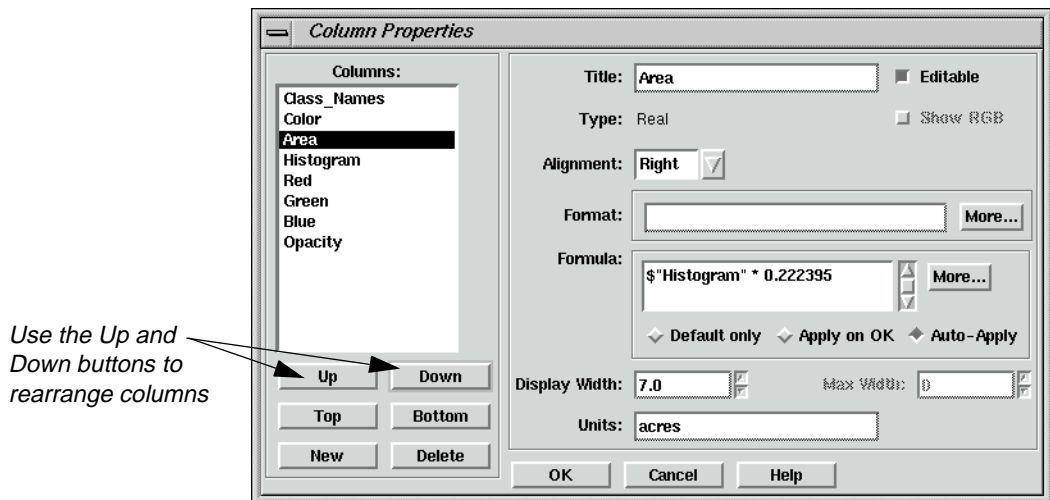

4. In the **Columns** field, select **Histogram**, and click the **Up** button four times to move it below the **Color** column.
5. Now select **Area**, and click the **Up** button until it is between **Color** and **Histogram**.
6. Click **OK** to apply these changes to the CellArray. The Column Properties dialog closes.

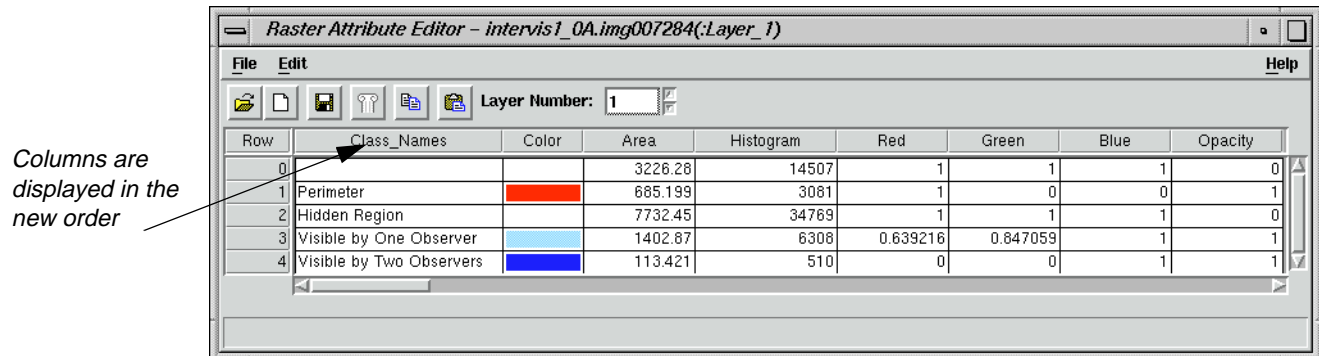

7. Select **File | Save** in the Raster Attribute Editor to save all edits to the CellArray.

You can now easily view the size and location of visible and hidden areas in the viewsheds.

### Query the Viewshed Layer

1. Click an area inside the Viewer. The corresponding class is highlighted in the CellArray of the Raster Attribute Editor dialog.
2. When you complete your query of the data, select **File | Close** in the Raster Attribute Editor to dismiss the dialog.



### Finish

1. Click **Close** in the Viewshed dialog.
2. Select **File | Close** in the Viewer.
3. Select **File | Close Image Drape** in the Image Drape viewer.



# Viewshed Analysis



# *Section III*

## *IMAGINE Professional™*



## Section III IMAGINE Professional™



# CHAPTER 16

## Spatial Modeler

---

### Introduction

In ERDAS IMAGINE, GIS analysis functions and algorithms are accessible through three main tools:

- script models created with the Spatial Modeler Language (SML)
- graphical models created with Model Maker
- pre-packaged functions in Image Interpreter

### Spatial Modeler Language

SML is the basis for all GIS functions in ERDAS IMAGINE, and it is the most powerful. It is a modeling language that allows you to create script (text) models for a variety of applications. Using models, you can create custom algorithms that best suit your data and objectives.

### Model Maker

Model Maker is essentially the SML with a graphical interface. This enables you to create graphical models using a palette of easy-to-use tools. Graphical models can be run, edited, saved, or converted to script form and edited further using the SML.

This tour guide focuses on Model Maker.

### Image Interpreter

The Image Interpreter houses a set of common functions that are created using either Model Maker or the SML. They have been given a dialog interface to match the other processes in ERDAS IMAGINE. In most cases, you can run these processes from a single dialog. However, the actual models are also delivered with the software, so that you can edit them if you want more customized processing.



*For more information on Image Interpreter functions, see "CHAPTER 11: Image Interpreter" on page 239.*



*Approximate completion time for this tour guide is 3 hours.*

---

### Start Model Maker

#### Prepare

ERDAS IMAGINE should be running and a Viewer should be open.

# Spatial Modeler

1. Click the Modeler icon on the ERDAS IMAGINE icon panel.



The **Spatial Modeler** menu displays.

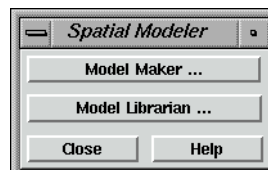

2. Click on **Model Maker** in the **Spatial Modeler** menu to start Model Maker.

The Model Maker viewer and tool palette open.

ERDAS IMAGINE is delivered with several sample graphical models that you can use as templates to create your own models. Open these models in Model Maker by selecting **File | Open** from the Model Maker viewer menu bar or clicking the Open icon on the tool bar.

3. Click **Close** in the **Spatial Modeler** menu to clear it from the screen.

---

## Create Sensitivity Layer

When three input thematic layers are combined, the resulting file has meaningful class values. These values may also be easily color coded in the final output file so that they are visible over the SPOT panchromatic reference data.

Therefore, you recode the data values of the input files so that the most environmentally sensitive areas have the highest class value and the least have the lowest value. You use class values 0-4, with 4 being the most environmentally sensitive and 0 being the least. This recode also facilitates defining the conditional statement within the function. These recodes are done at the same time the files are defined in the Raster dialog.

### Prepare

You must have Model Maker running.

*NOTE: Refer to the model pictured on page 343 when going through the following steps.*

1. Click on the Raster icon in the Model Maker tool palette.



2. Click on the Lock icon.



3. Click in the Model Maker viewer in four different places to place three input Raster graphics and one output Raster graphic.
4. Select the Function icon in the Model Maker tool palette.



5. Click in the Model Maker viewer window to place a Function graphic on the page between the three inputs and the one output Raster graphic.
6. Select the Connect icon in the Model Maker tool palette.



7. Connect the three input Raster graphics to the Function and the Function to the output Raster by simply dragging from one graphic to another.

Your model should look similar to the following example:

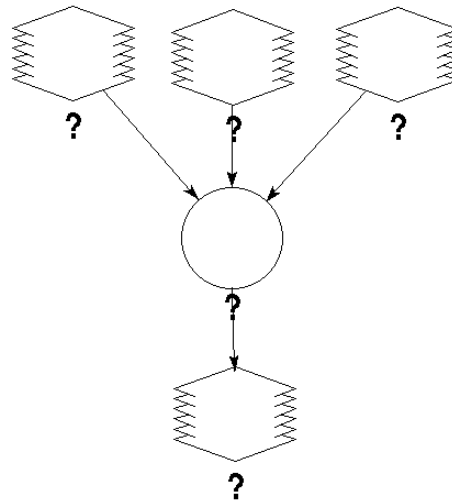

8. In the Model Maker tool palette, click the Lock icon to disable the lock tool.
9. Click the Select icon.



# Spatial Modeler



10. In the Model Maker viewer menu bar, select **Model | Set Window** to define the working window for the model.

The Set Window dialog opens.

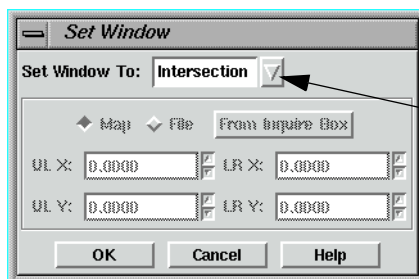

*Click on this popup list to select Intersection*

You want the model to work on the intersection of the input files. The default setting is the union of these files.

11. In the Set Window dialog, click on the **Set Window To** popup list and select **Intersection**.
12. Click **OK** in the Set Window dialog.

## Define Input Slope Layer

1. In the Model Maker viewer, double-click the first input Raster graphic.

The graphic is highlighted and the Raster dialog opens.



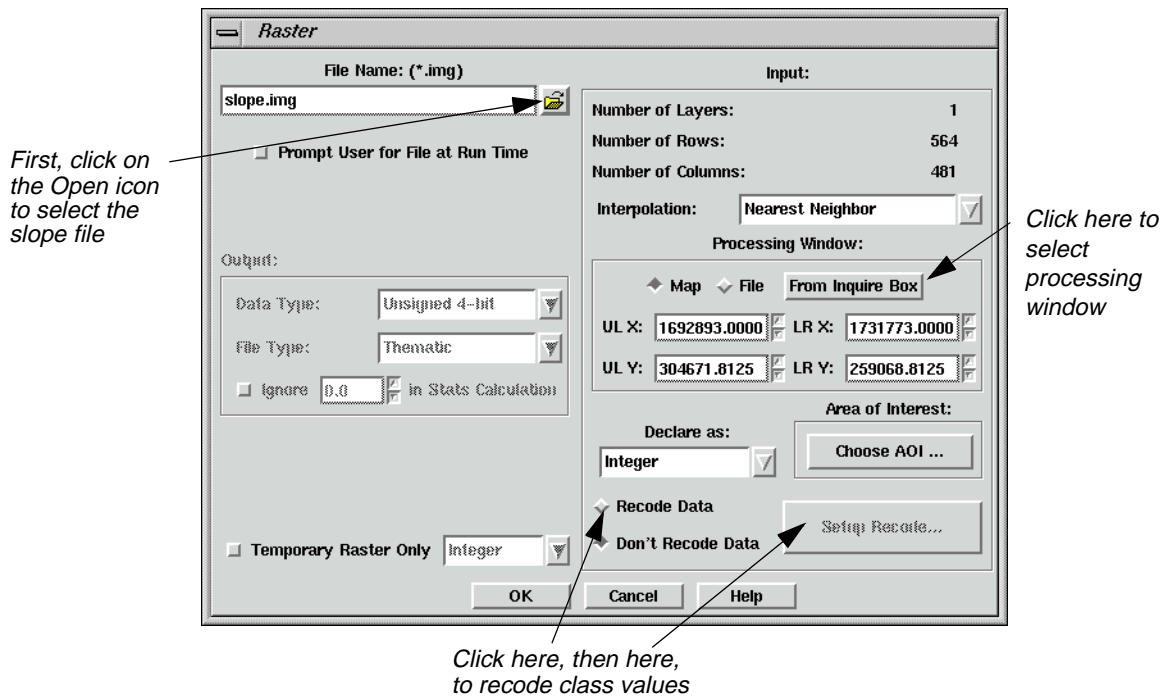

2. In the Raster dialog, click on the Open icon under **File Name**.



The File Name dialog opens.

3. In the File Name dialog under **Filename**, click on the file **slope.img** and then click **OK**.

This image has some noise around the edges that you want to eliminate, so you use a subset of this image in the model. To take a subset, you display the file in a Viewer and select the processing window with an inquire box.

### Display Slope Layer

1. Click the Open icon in a Viewer (or select **File | Open | Raster Layer** from the menu bar).



The Select Layer To Add dialog opens.



# Spatial Modeler

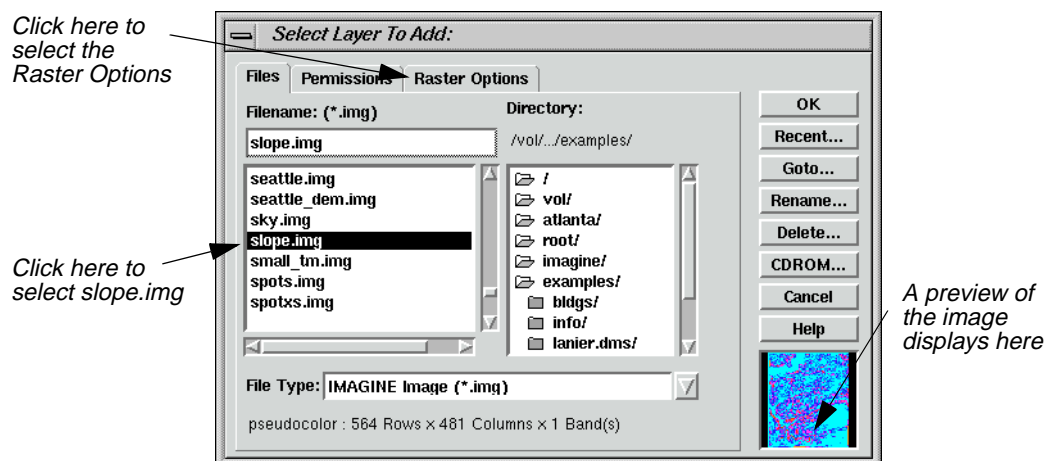

2. In the Select Layer To Add dialog under **Filename**, click on the file **slope.img**.
3. Click on the **Raster Options** tab at the top of the dialog, and then select the **Fit to Frame** option.
4. Click **OK** in the Select Layer To Add dialog to display the file in the Viewer.

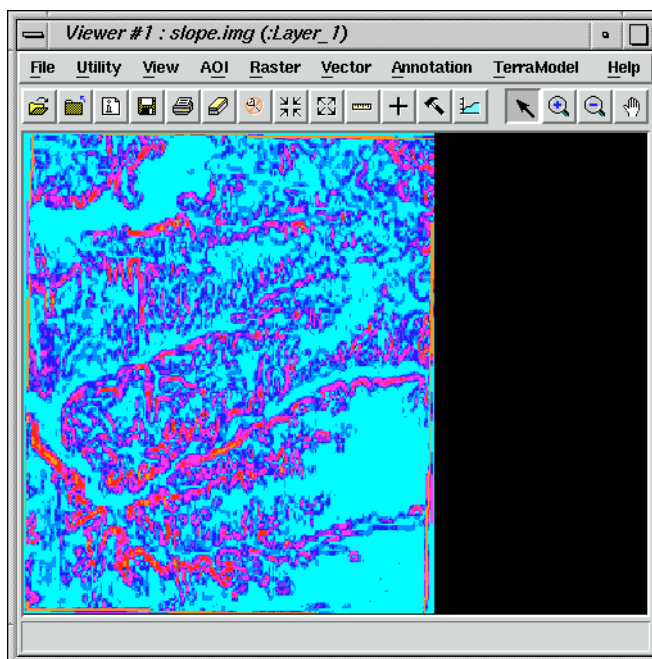

## Select Area to Use

1. With your cursor in the Viewer, right-hold **Quick View | Inquire Box**.

A white inquire box opens near the center of the image displayed in the Viewer. The Inquire Box Coordinates dialog also opens. The title of this dialog is Viewer #1: **slope.img**.

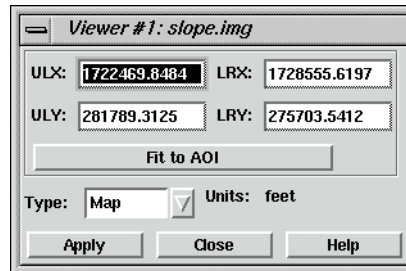

2. Hold inside the inquire box in the Viewer and drag the box to the desired image area. You use the entire image area you select, except for the edges.

You can reduce or enlarge the inquire box by dragging on the sides or corners.

*NOTE: You may wish to select nearly the entire image area with the inquire box, as this is helpful when you compare your output image with the example output image at the end of this exercise.*

3. In the Raster dialog, under **Processing Window**, click **From Inquire Box**.

The coordinates in the Raster dialog now match the coordinates in the Inquire Box Coordinates dialog.

4. Click **Close** in the Inquire Box Coordinates dialog.

### Recode Classes

Now that the processing window is defined, you can recode the values.

1. In the Raster dialog, click the **Recode Data** option.
2. Click the **Setup Recode** button.

The Recode dialog opens.

You recode this file so that the classes with a slope greater than 25% have a class value of 1 and all other classes are 0 (zero). This is easy to do using the **Criteria** option of the **Row Selection** menu.

3. With your cursor in the **Value** column of the Recode dialog, right-hold **Row Selection | Criteria**.

The Selection Criteria dialog opens.



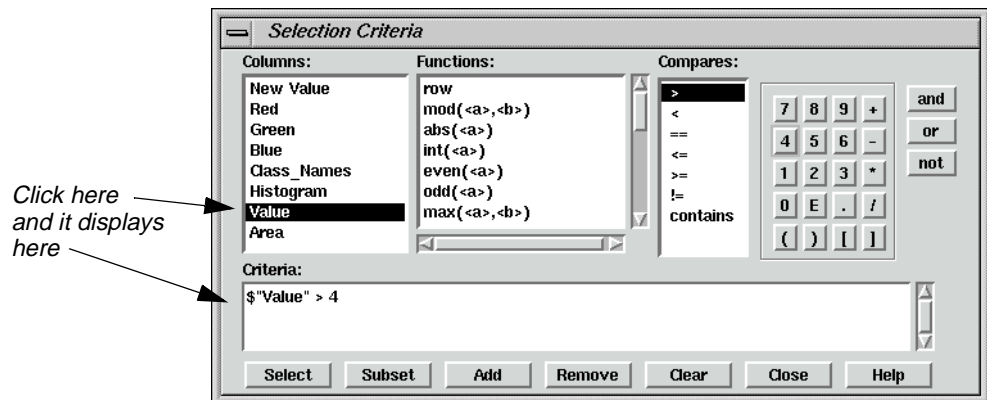

Next, you select all classes with a slope greater than 25%. By looking at the Recode dialog, you can see that all classes greater than **Value 4** have a slope greater than 25%. You can then invert your selection to recode all classes with values less than 25%.

4. In the Selection Criteria dialog, under **Columns**, click **Value**.

**\$ "Value"** is displayed in the **Criteria** window at the bottom of the dialog.

5. Under **Compares**, click **>**.

6. In the calculator, click the number **4**.

The **Criteria** window now shows **\$ "Value" > 4**.

7. In the Selection Criteria dialog, click **Select** to select all classes meeting that criteria in the Recode dialog.

All classes greater than **4** are highlighted in yellow in the Recode dialog.

8. Click **Close** in the Selection Criteria dialog.

9. In the Recode dialog, confirm that the **New Value** is set to **1**.

10. In the Recode dialog, click **Change Selected Rows** to give the selected classes a new value of **1**.

11. With your cursor in the **Value** column of the Recode dialog, right-hold **Row Selection | Invert Selection** to deselect all currently selected classes and select all nonselected classes.

12. Enter a **New Value** of **0** in the Recode dialog.

13. Click **Change Selected Rows** to give the selected classes a new value of **0**.

14. Click **OK** in the Recode dialog.

The Recode dialog closes.

15. Click **OK** in the Raster dialog.

The Raster dialog closes. The Raster graphic in the Model Maker viewer now has **n1\_slope\_RC** written under it.

### Define Input Flood Plain Layer

1. Double-click the second Raster graphic in the Model Maker viewer.  
The graphic is highlighted and the Raster dialog opens.
2. In the Raster dialog, click on the Open icon under **File Name**.



The File Name dialog opens.

3. In the File Name dialog under **Filename**, select the file **floodplain.img** and then click **OK**.  
This file does not need to be subset or recoded.
4. Click **OK** in the Raster dialog.  
The Raster dialog closes and **n2\_floodplain** is written underneath the second Raster graphic.

### Define Input Land Cover Layer

1. Double-click the third Raster graphic in the Model Maker viewer.  
The graphic is highlighted and the Raster dialog opens.
2. In the Raster dialog, click on the Open icon under **File Name**.



The File Name dialog opens.

3. In the File Name dialog under **Filename**, select the file **landcover.img** and then click **OK**.  
You recode this file so that the most sensitive areas have the highest class value.
4. In the Raster dialog, click the **Recode Data** option.
5. Click the **Setup Recode** button.  
The Recode dialog opens.
6. In the **Value** column of the Recode dialog, click on **1** to select it.



7. In the **New Value** box, enter a **New Value** of **4**.
8. Click **Change Selected Rows** to recode **Riparian** to **4**.  
Now both **Riparian** and **Wetlands** have a class value of **4**.
9. With your cursor in the **Value** column, right-hold **Row Selection | Invert Selection**.  
Now all classes are selected except one (**Riparian**).
10. With your cursor in the **Value** column, Shift-click on **4** to deselect **Wetlands**.
11. With your cursor in the **Value** column, Shift-click on **0** to deselect the background.

Your Recode dialog looks like the following:

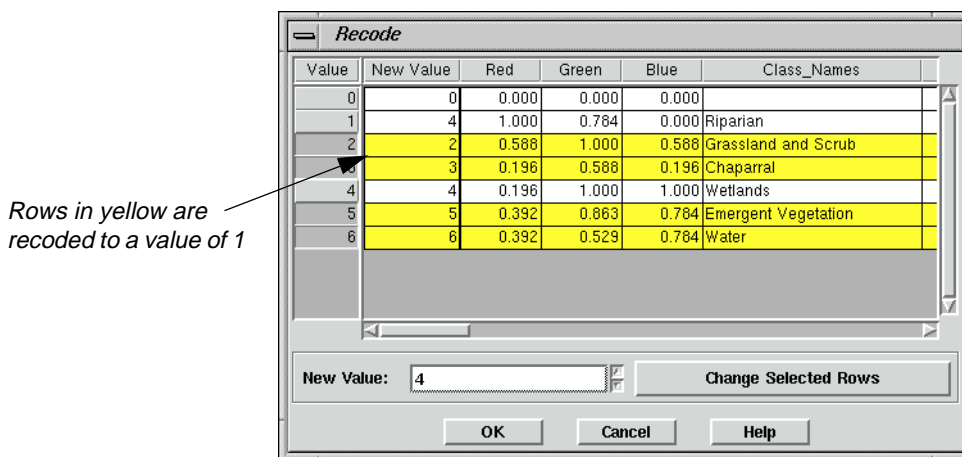

12. Enter a **New Value** of **1**.
13. Click **Change Selected Rows**.
14. Click **OK** to close the Recode dialog.
15. In the Raster dialog, click **OK**.

**n3\_landcover\_RC** is written under the third Raster graphic in the Model Maker viewer.

Now, all of the files are set up so that the most sensitive areas have the higher class values:

**Table 16-1: Class Values for n3\_landcover\_RC**

Class	Value
> 25 percent slope	1
flood plain	1
riparian & wetlands	4
undeveloped land	1

These values are used in the next step to create the sensitivity file.

### Define Function

1. In the Model Maker viewer, double-click the Function graphic.

The graphic is highlighted and the Function Definition dialog opens.

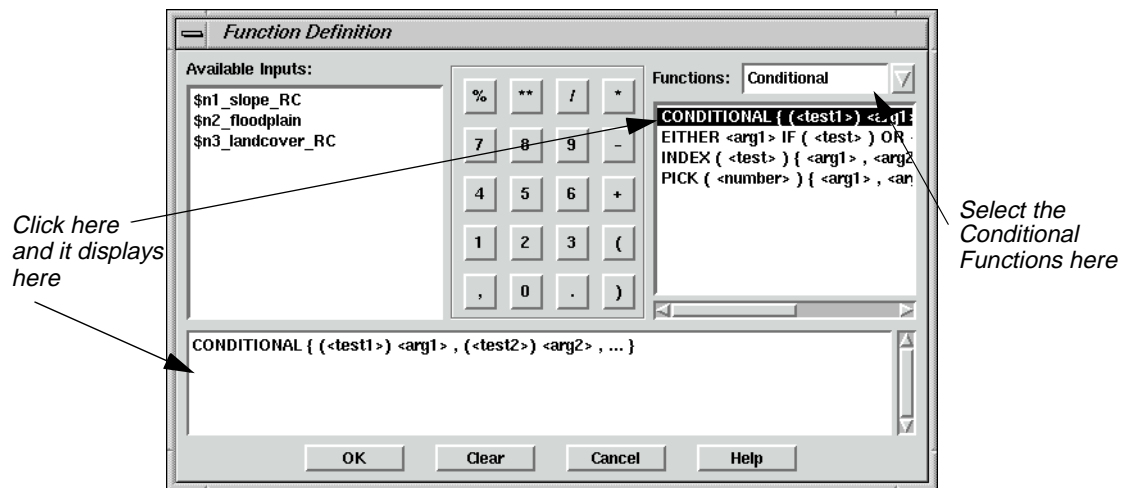

Next, you use a conditional statement to create a new file that contains only the environmentally sensitive areas.

2. In the Function Definition dialog, click on the **Functions** popup list and select **Conditional**.
3. Click on **CONDITIONAL** in the box below **Functions**.

The **CONDITIONAL** function is placed in the function definition window at the bottom of the dialog.

4. Type the following statement in the definition box, replacing the previously created condition statement:

```
CONDITIONAL { ($n3_landcover_RC==0)0,
              ($n3_landcover_RC==4)4,
              ($n1_slope_RC==1)3,
              ($n2_floodplain==1)2,
              ($n3_landcover_RC==1)1 }
```

*NOTE: The file names can be added to your function definition simply by clicking in the appropriate spot in the function definition, and then clicking on the file name in the list of Available Inputs.*



This creates a new output file with the class values 0-4. Each class contains the following:

**Table 16-2: Conditional Statement Class Values**

Class	Contents
0	developed
1	undeveloped land
2	flood plain
3	> 25 percent slope
4	riparian & wetlands

Areas with a class value of 4 are the most environmentally sensitive, and are therefore unsuitable for development. Classes 3-1 are also environmentally sensitive, but proportionally less so. Further analysis determines whether classes 3-1 are eligible for development.

5. Take a moment to check over the conditional statement you just entered to be sure it is 100% accurate. The model does not run if the information has not been entered accurately.
6. Click **OK** in the Function Definition dialog.

The Function Definition dialog closes and **CONDITIONAL** is written under the Function graphic.

## Define Output Raster Layer

1. In the Model Maker viewer, double-click the output Raster graphic.  
The graphic is highlighted and the Raster dialog opens.
2. Under **File Name**, type the name **sensitivity.img** for the new output file.  
*NOTE: Be sure that you specify a directory in which you have write permission.*
3. Click the **Delete if Exists** option so that the output file is automatically overwritten when the model is run again.
4. Click on the **File Type** popup list and select **Thematic**.
5. Click **OK** in the Raster dialog.

The Raster dialog closes and **n4\_sensitivity** is written under the output Raster graphic in the Model Maker viewer.

Your model should look similar to the following example:



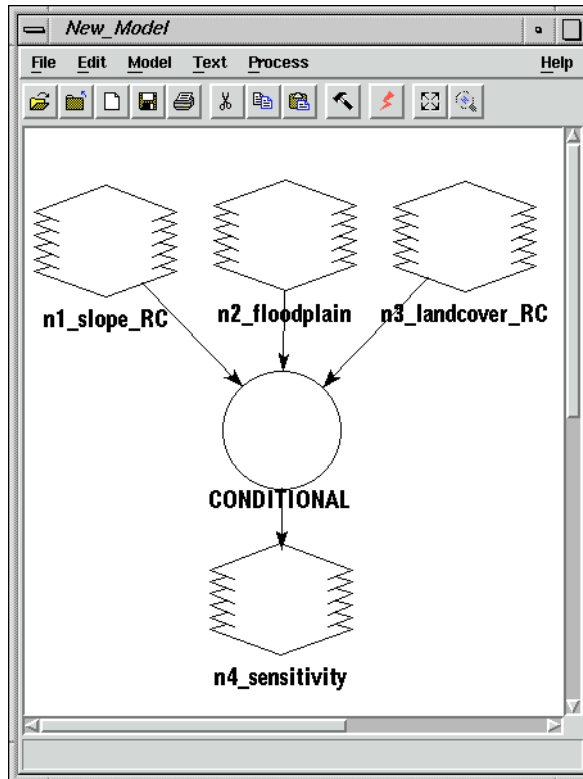

## Save and Run the Model

1. In the Model Maker viewer tool bar, click the Save icon (or select **File | Save As** from the Model Maker viewer menu bar) to save the model.



The Save Model dialog opens.

2. Enter a name for the model. Be sure you are saving in a directory in which you have write permission.



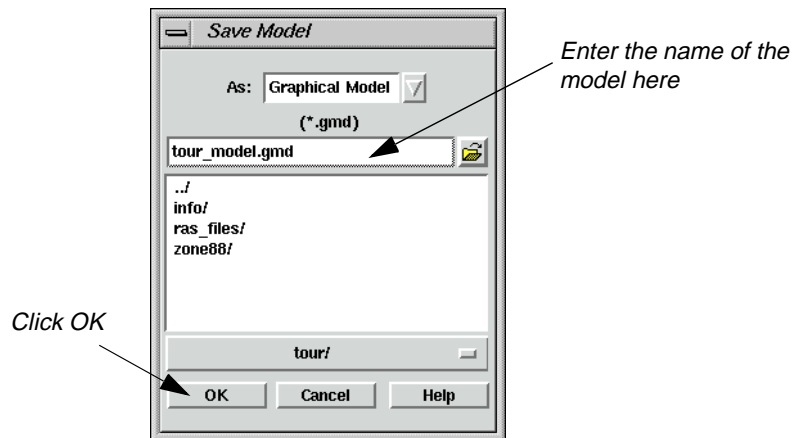

3. Click **OK** in the Save Model dialog.

### Run the Model

You can now run this portion of the model to see if it works correctly.

1. In the Model Maker viewer tool bar, click the Run icon (or select **Process | Run** from the Model Maker viewer menu bar) to run the model.



While the model runs, a Job Status dialog opens, reporting the status of the model.

2. When the model is finished, click **OK** in the Job Status dialog.

---

## Enhance SPOT Data

To enhance the detail in the SPOT data, you run a convolution kernel over it before it is combined with the sensitivity layer. This portion of the model includes a Raster input, a Matrix input, a Function, and a Raster output.

Follow the next series of steps to create this portion of the model in a new Model Maker viewer. After you have verified that this portion runs correctly, you paste it into the first Model Maker viewer.

*NOTE: Refer to the model pictured on page 356 when going through the following steps.*

1. Click the new Window icon in the Model Maker viewer tool bar or select **File | New** to create a new Model Maker viewer.



The new Model Maker viewer opens.

2. Click on the Raster icon in the Model Maker tool palette, then click the Lock icon.

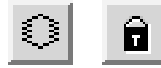

3. Click twice in the Model Maker viewer to place the input and output Raster graphics.
4. Click on the Matrix icon in the Model Maker tool palette.



5. Click in the Model Maker viewer to place the input Matrix graphic.  
This is where you define the convolution kernel.
6. Click on the Function icon in the Model Maker tool palette.



7. Click on the Model Maker viewer to place a Function graphic on the page.  
Place the Function graphic between the two inputs and the output Raster graphic.
8. Click on the Connect icon.



9. Connect the input Raster graphic to the Function, the input Matrix to the Function, and the Function to the output Raster.



## Spatial Modeler

This part of the model looks similar to the following example:

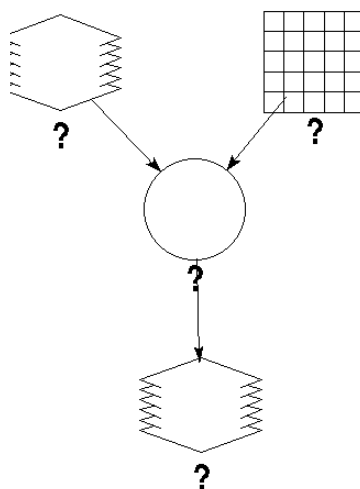

10. In the Model Maker tool palette, click the Lock icon to disable the Lock tool.
11. Click the Select icon.



### Define Input SPOT Layer

1. Double-click the input Raster graphic in the Model Maker viewer.  
The graphic is highlighted and the Raster dialog opens.
2. In the Raster dialog, click on the Open icon under **File Name**.



The File Name dialog opens.

3. In the File Name dialog under **Filename**, click on the file **spots.img** and then click **OK**.
4. Click **OK** in the Raster dialog.

The Raster dialog closes, and **n1\_spots** is written under the input Raster graphic.

### Define Input Convolution Kernel

In Model Maker, you have access to built-in kernels or you can create your own. In this exercise, use the built-in  $5 \times 5$  summary filter.

1. Double-click the input Matrix graphic.

The Matrix Definition and Matrix dialogs open.

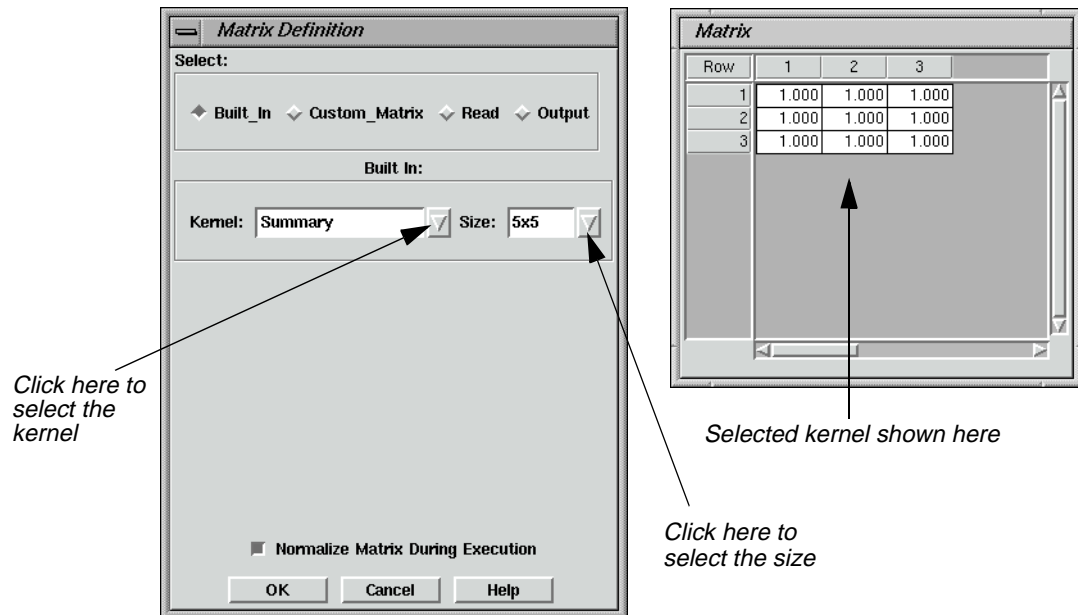

2. In the Matrix Definition dialog, click on the **Kernel** popup list and select **Summary**.
3. Click on the **Size** popup list and select **5x5**.

The kernel displays in the Matrix dialog.

4. Click **OK** in the Matrix Definition dialog.

The Matrix Definition and Matrix dialogs close, and **n3\_Summary** is written under the Matrix graphic in the Model Maker viewer.

## Define Function

1. Double-click the Function graphic in the Model Maker viewer.

The Function Definition dialog opens.



## Spatial Modeler

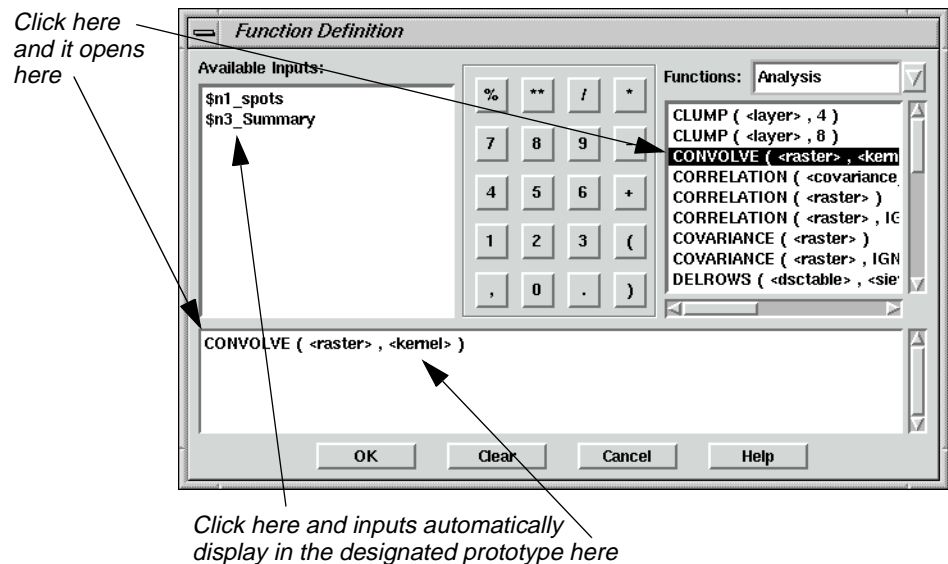

2. Click **CONVOLVE** from the list below **Functions**.

The **CONVOLVE** statement displays in the function definition window.

3. Click in the first prototype (<raster>), and then click on **\$n1\_spots** under **Available Inputs** to define the raster input.
4. Click in the second prototype (<kernel>), and then click on **\$n3\_Summary** under **Available Inputs** to define the kernel.
5. Click **OK** to close the Function Definition dialog.

The Function Definition dialog closes and **CONVOLVE** is written below the Function graphic in the Model Maker viewer.

### Define Output Raster Layer

1. Double-click the output Raster graphic in the Model Maker viewer.

The Raster dialog opens.

2. In the Raster dialog under **File Name**, type the name **spot\_summary** for the new output file. The .img extension is added automatically.

Be sure that you specify a directory in which you have write permission.

3. Click on the **Delete if Exists** option.
4. Confirm that **Continuous** is selected for the **File Type**.
5. Click **OK** in the Raster dialog.



The Raster dialog closes and **n2\_spot\_summary** is written under the Raster graphic in the Model Maker viewer.

### Save and Run the Model

1. In the Model Maker viewer tool bar, click the Save icon (or select **File | Save As** from the Model Maker viewer menu bar) to save the model.



The Save Model dialog opens.

2. Enter a name for the model, such as **convolve.gmd**, being sure that you specify a directory in which you have write permission.
3. Click **OK** in the Save Model dialog.

### Run the Model

You can now run this portion of the model to see if it works correctly.

1. In the Model Maker viewer tool bar, click the Run icon (or select **Process | Run** from the Model Maker viewer menu bar) to run the model.



While the model runs, a Status box opens, reporting the status of the model.

2. When the model is finished running, click **OK** in the Status box.

### Combine Models

You now use the Copy and Paste commands to combine these two separate models into one. Make sure that both models you created are open.

1. In the menu bar of the second model you created, select **Edit | Select All**.



---

*You can also select objects by clicking and dragging in the Model Maker viewer. All objects contained within the selection box that you draw are selected.*

2. Click the Copy icon in the tool bar of the same model (or select **Edit | Copy** from the menu bar) to copy the selected objects to the paste buffer.



## Spatial Modeler

3. Click the Paste icon in the tool bar of the first model (or select **Edit | Paste** from the menu bar) to paste the second model into the first Model Maker viewer.



The second model is pasted on top of the first model.

4. Close the second Model Maker viewer by selecting **File | Close**.

*NOTE: Do not select **File | Close All**, as this closes both of the models.*

5. Drag the pasted model to the right in the Model Maker viewer, so that it does not overlap the first model.

You can resize the Model Maker viewer to see the entire model.

6. Click outside of the selection to deselect everything.

---

### Combine Sensitivity Layer with SPOT Data

With both the thematic sensitivity layer (**sensitivity.img**) and the SPOT data (**spot\_summary.img**) defined, you can use these two files as the input raster layers in a function that combines the two files into one final output. A Scalar is also used in the function to offset the data file values in the SPOT image by five, so that the sensitivity analysis does not overwrite any SPOT data.

*NOTE: Refer to the model pictured on page 364 when going through the next set of steps.*

1. Click on the Function icon in the Model Maker tool palette.



2. Click in the Model Maker viewer below the output raster graphics (**n4\_sensitivity** and **n7\_spot\_summary**) to place a Function graphic.
3. Click on the Scalar icon in the Model Maker tool palette.



4. Click in the Model Maker viewer to the left of the Function graphic you just positioned to place an input Scalar.
5. Click on the Raster icon in the Model Maker tool palette.



6. Click in the Model Maker viewer below the Function to place an output Raster graphic.



## Combine Sensitivity Layer with SPOT Data

- Click on the Connect icon and then on the Lock icon.



- Connect the input Raster graphics (**n4\_sensitivity** and **n7\_spot\_summary**) to the Function, the input Scalar to the Function, and then the Function to the output Raster.
- Click the Lock icon to disable the lock tool.



- Click the Select icon.



### Define Input Scalar

- Double-click the Scalar graphic in the Model Maker viewer.

The Scalar dialog opens.

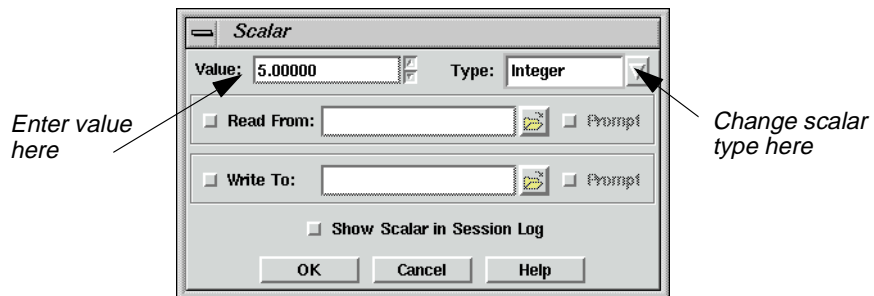

- In the Scalar dialog, enter a **Value** of 5.
- Click on the **Type** popup list and select **Integer**.
- Click **OK** in the Scalar dialog.

The Scalar dialog closes and **n11\_Integer** displays under the Scalar graphic in the Model Maker viewer.

### Define Function

Next, you create a file that shows sensitivity data where they exist and allows the SPOT data to show in all other areas. Therefore, you use the conditional statement.

- Double-click the untitled Function graphic in the Model Maker viewer.

The Function Definition dialog opens.



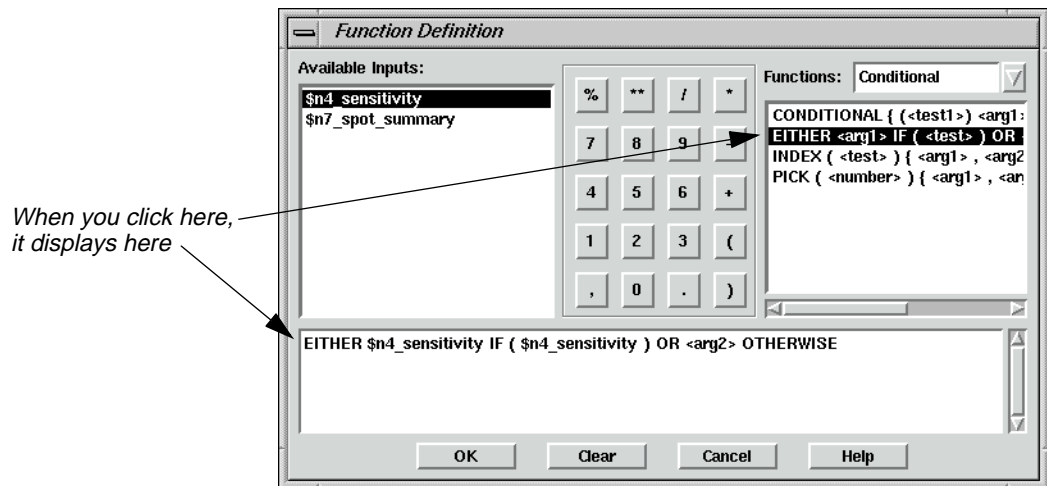

2. In the Function Definition dialog, click on the **Functions** popup list and select **Conditional**.
3. In the list under **Functions**, click on **EITHER**.

The **EITHER** statement and prototype arguments display in the function definition window.

4. Double-click in the first prototype **<arg1>**, then click **\$n4\_sensitivity** under **Available Inputs** to automatically replace the prototype with an argument.
5. Double-click in the prototype **<test>**, then click **\$n4\_sensitivity**.

The function definition now reads:

**EITHER \$n4\_sensitivity IF (\$n4\_sensitivity) OR <arg2> OTHERWISE**

6. Click on the **Functions** popup list and select **Analysis**.
7. Double-click the remaining prototype, **<arg2>**, and then scroll down the list under **Functions** and click on the first **STRETCH** function to replace **<arg2>**.

The **STRETCH** function and its prototype arguments are inserted into the function definition.

## Combine Sensitivity Layer with SPOT Data

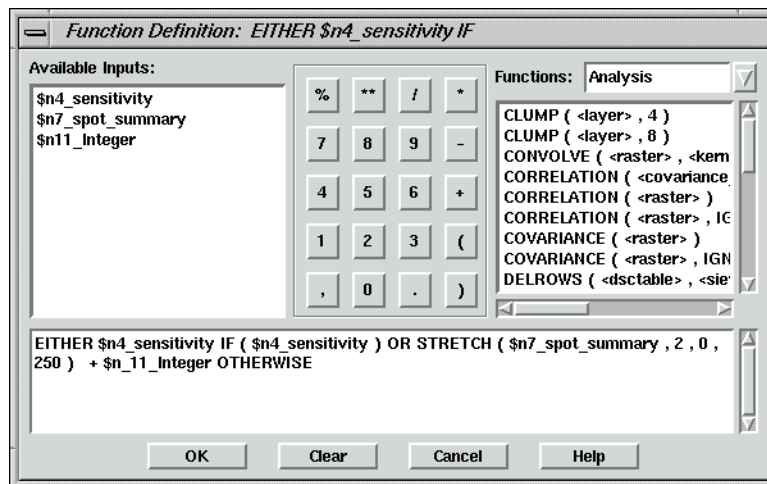

8. Click on **<raster>**, then click on the file name **\$n7\_spot\_summary** under **Available Inputs**.
9. Click on **<stdcount>**, then click on the number **2** on the calculator.
10. Using this same method, replace **<min>** with **0** and **<max>** with **250**.

The **STRETCH** function uses two standard deviations to stretch the data file values of **spot\_summary.img** between 0 and 250. The scalar is added to ensure that there are no data file values between 0 and 4, since these are the values in the sensitivity file.

11. Click in front of **OTHERWISE** to insert the cursor in the function definition.
12. Click **+** on the calculator, then **\$n11\_Integer** under **Available Inputs**, to add the scalar to the function.

The final function definition should look like the following:

```
EITHER $n4_sensitivity IF ( $n4_sensitivity ) OR STRETCH ( $n7_spot_summary , 2 , 0 , 250 ) + $n11_Integer OTHERWISE
```

13. Click **OK** in the Function Definition dialog.

The Function Definition dialog closes, and **EITHER \$n4\_sensitivity IF** is written under the Function graphic in the Model Maker viewer.

### Define Output Raster Layer

1. Double-click the untitled output Raster graphic.



# Spatial Modeler

The Raster dialog opens.

2. In the Raster dialog, enter the file name **sensitivity\_spot** for the new output file.  
Be sure that you specify a directory in which you have write permission.
3. Click on the **Delete if Exists** option.
4. Click on the **File Type** popup list and select **Thematic**.
5. Click **OK** in the Raster dialog.

The Raster dialog closes, and **n12\_sensitivity\_spot** is written under the Raster graphic in the Model Maker viewer.

Your final model should look like the following example:

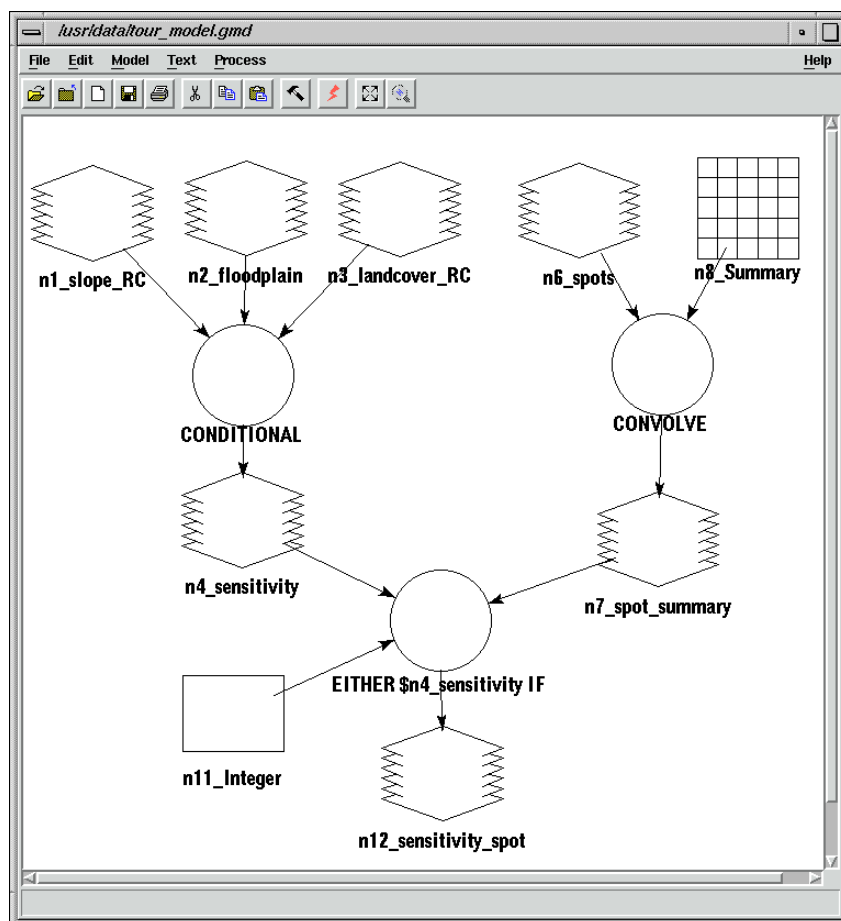

## Save and Run the Model

1. In the Model Maker viewer tool bar, click the Save icon (or select **File | Save** from the Model Maker viewer menu bar) to save the model.



### Run the Model

You can now run the entire model.

2. In the Model Maker viewer tool bar, click the Run icon (or select **Process | Run** from the Model Maker viewer menu bar) to run the model.



While the model runs, a Job Status dialog opens, reporting the status of the model.

3. When the model is finished running, click **OK** in the Job Status dialog.

---

## Display New Layer

Once your model has run, the new output file is created. You can display this file in a Viewer and modify the class colors and class names of the overlaid sensitivity analysis.

### Prepare

You must have run the model and you must have a Viewer open.

1. In the Viewer tool bar, click the Open icon (or select **File | Open | Raster Layer** from the Viewer menu bar).



The Select Layer To Add dialog opens.

2. Under **Filename**, click the file **sensitivity\_spot.img**.
3. Click on the **Raster Options** tab at the top of the dialog and confirm that the **Fit to Frame** option is selected, so that you can see the entire layer.
4. Click **OK** to display the file.



# Spatial Modeler

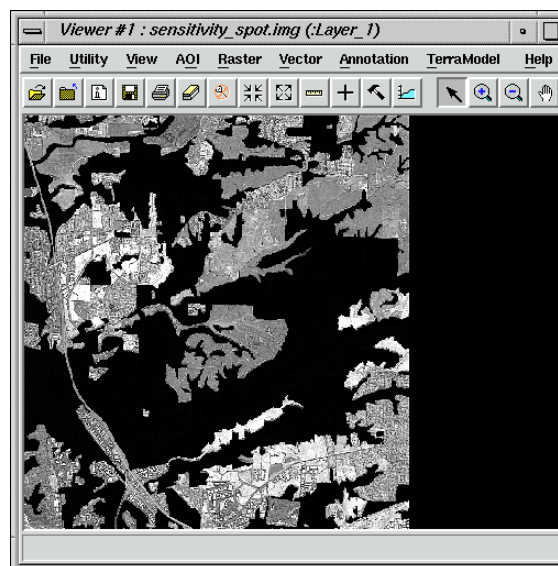

## Adjust Colors

The sensitivity analysis is displayed with a gray scale color scheme.

1. In the Viewer menu bar, select **Raster | Attributes**.

The Raster Attribute Editor opens. You add a Class Names column.

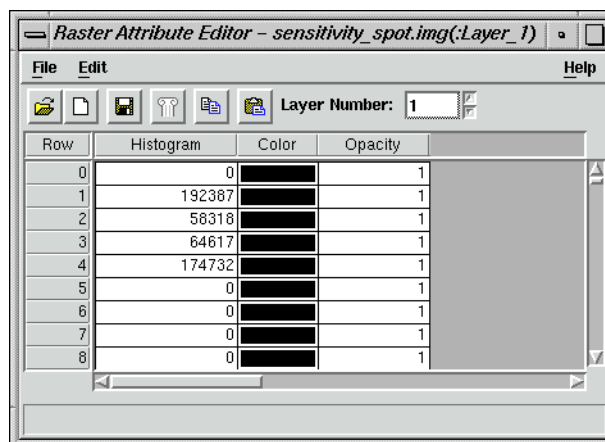

2. In the Raster Attribute Editor, select **Edit | Add Class Names**.

A new **Class\_Names** column is added to the CellArray.

Next, rearrange the columns so that the **Color** and **Class Name** columns come first. This makes it easier to change the colors of the overlaid sensitivity analysis.

3. In the Raster Attribute Editor, select **Edit | Column Properties**.

The Column Properties dialog opens.

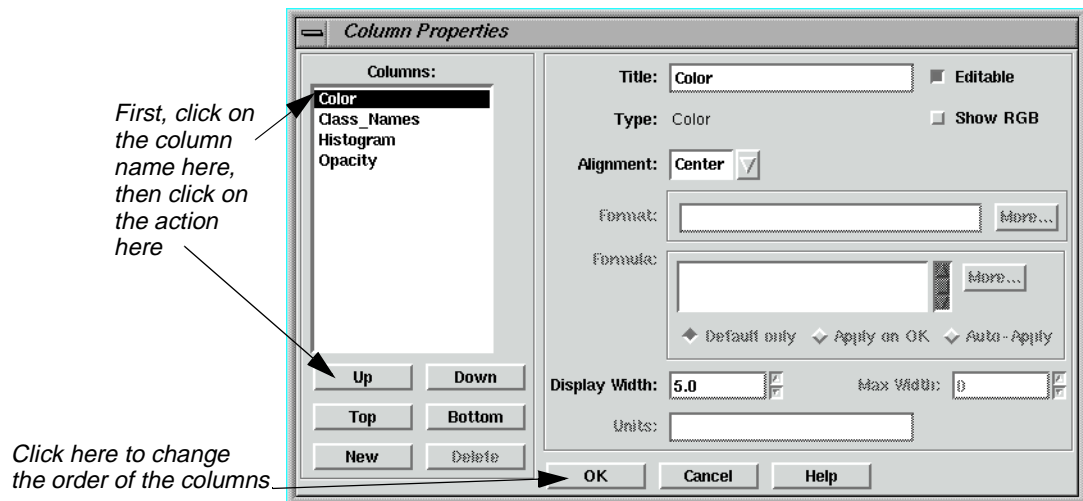

4. Click on **Color** under **Columns**, then click **Top** to make **Color** the first column in the Raster Attribute Editor.
5. Click **OK** in the Column Properties dialog to change the order of the columns.

The Raster Attribute Editor now looks similar to the following example:

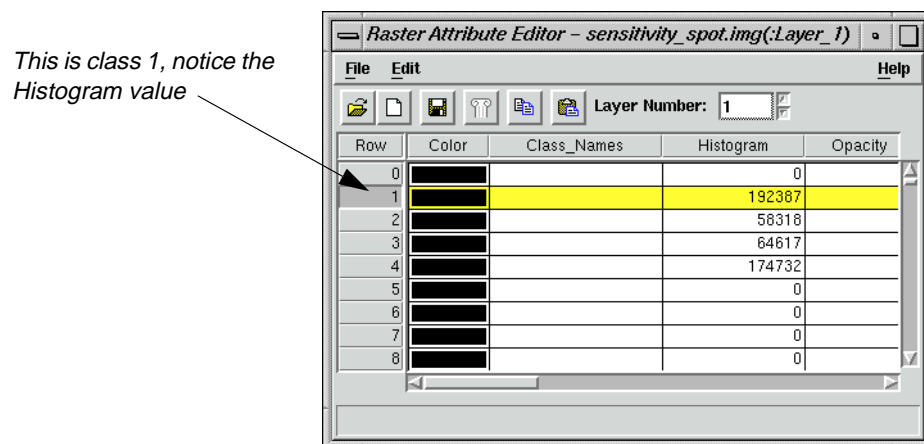

Next, change the colors and class names.

6. To change the color of the class 1, with your pointer over the color patch for that class, right-hold **Other**.

The Color Chooser dialog opens.



## Spatial Modeler

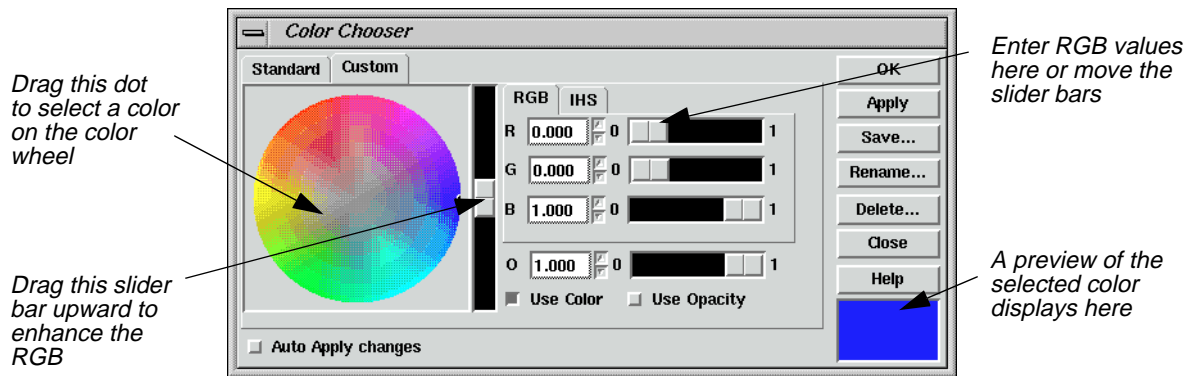

This dialog gives you several options for changing the class colors. You can move the black dot on the color wheel, use the slider bars, select colors from a library (under the **Standard** tab), or enter RGB values.

7. Experiment with each of these methods to alter the class colors of classes 1 through 4. Change class 1 to **Green**, class 2 to **Yellow**, class 3 to **Tan**, and class 4 to **Red**.

When you have selected the desired color for a class, click **Apply** and then **Close** in the Color Selector dialog. Then redisplay the Color Chooser for the next class by moving your cursor to that color patch and right-holding a specific color or **Other**.

8. Click in the **Class\_Names** column of class 1.
9. Type **Undeveloped Land**. Press Return on your keyboard.  
Your cursor is now in the class name field of class 2.
10. Type **Floodplain** for class 2. Press Return.
11. Type **>25 Percent Slope** for class 3. Press Return.
12. Type **Riparian and Wetlands** for class 4. Press Return.



New class names go in this column

Row	Color	Class_Names	Histogram	Opacity
0			0	
1	Blue	Undeveloped Land	192387	
2	Yellow	Floodplain	58318	
3	Purple	>25 Percent Slope	64617	
4	Red	Riparian and Wetlands	174732	
5			0	
6			0	
7			0	
8			0	

## Test the Output

The following steps describe how to compare your output with the one delivered with ERDAS IMAGINE.

### Prepare

You must have completed the Spatial Modeler tour guide up to this point, creating **sensitivity\_spot.img** in the process. The file **sensitivity\_spot.img** should be displayed in a Viewer.

1. Display the file **<IMAGINE\_HOME>/examples/modeler\_output.img** in a second Viewer.
2. Select **Session | Tile Viewers** from the ERDAS IMAGINE menu bar to position the two Viewers side by side, so that you can view both images at once.

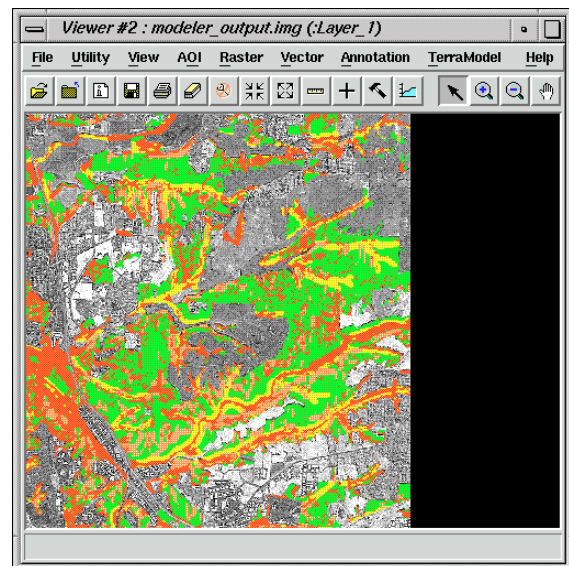
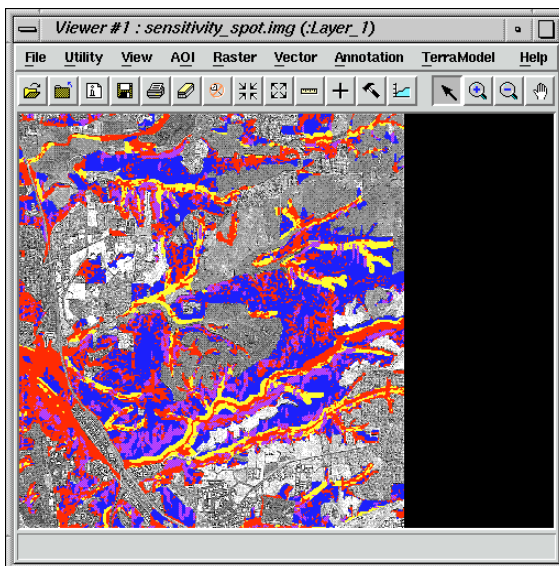

## Spatial Modeler

3. In Viewer #1, select **View | Link/Unlink Viewers | Geographical**.

A Link/Unlink Instructions dialog opens, instructing you to click in Viewer #2 to link the two Viewers.

4. Click in Viewer #2 to link the two Viewers and close the Link/Unlink Instructions dialog.



---

*If **sensitivity\_spot.img** is a subset of **modeler\_output.img**, a white bounding box displays in Viewer #2 (**modeler\_output.img**), marking the area of the image that is shown in Viewer #1 (**sensitivity\_spot.img**).*

5. Select **Utility | Inquire Cursor** from either Viewer's menu bar.
6. Compare the two images using the Inquire Cursor.
7. When you are finished, click **Close** in the Inquire Cursor dialog.
8. Right-click in the Viewer displaying **sensitivity\_spot.img** to access the **Quick View** menu.
9. Select **Geo Link/Unlink**.
10. Click in the Viewer containing **modeler\_output.img** to break the link.

---

### Add Annotation to a Model

You can add annotation to a model to make it more understandable to others, or to help you remember what the model does. It is also a helpful organizational tool if you create several models and need to keep track of them all.

Next, add a title and an explanation of each function to the model you just created.

#### Prepare

You must have the model open.

*NOTE: Refer to the model pictured on page 373 when going through the next set of steps.*

#### Add a Title

1. Select the Text icon in the Model Maker tool palette.



2. Click near the center of the top of the model page to indicate where you want to place the text.

The Text String dialog opens.



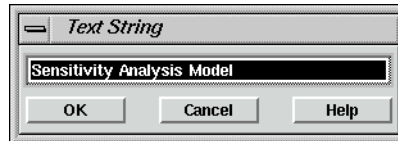

3. Type these words in the Text String dialog:

**Sensitivity Analysis Model**

4. Press Return on your keyboard, and then click **OK** in the Text String dialog.

The text string you typed in step 3. displays on the page.

### Format Text

1. Click on the text string you just added to select it. The string is reversed out (white on black) when it is selected.
2. On the Model Maker viewer menu bar, select **Text | Size | 24**.

The text string is redisplayed at the new point size. If the text overwrites any of the graphics in the model, you can simply click on it to select it and then drag it to a new location.

3. In the Model Maker viewer menu bar, select **Text | Style | Bold**.

The text string is redisplayed in bold type.

*NOTE: If you want to edit a line of text, simply double-click it to bring up the Text String dialog again. Correct your entry or type a new one.*

### Add Text to a Function Graphic

1. In the Model Maker tool palette, select the Text tool and then the Lock tool to add text to the first Function graphic.
2. Click on the center of the **CONDITIONAL** Function graphic, toward the top of the graphic.

The Text String dialog opens.

3. Type the following words in the Text String dialog:

**Create a sensitivity file by**

4. Press Return on your keyboard, and then click **OK** in the Text String dialog.
5. Click under the first line of text to add another line.
6. In the Text String dialog, type:

**combining Slope, Floodplain, and Landcover**

7. Press Return on your keyboard and then click **OK** in the Text String dialog.
8. Repeat step 5. to add a third line of text:



## using a conditional statement.

9. Click **OK**.

All three text strings display over the Function graphic, but they are very large.

### Format Text

1. In the Model Maker tool palette, click on the Lock icon to disable the lock tool and then click on the Select icon.
2. Click on the first line on the Function graphic to select it.
3. Shift-click on the second and third lines to add to the selection.
4. Using the same procedure you used to change the point size and style of the title, change these lines to **14** points, **Normal**.

You may also want to adjust the positioning (simply drag on the text).

### Add Text to Other Graphics

1. Add the following lines of text to the **CONVOLVE** function:

#### Enhance the SPOT image using a summary filter.

2. Next, add these two lines to the final output raster (**n12\_sensitivity\_spot**):

#### Overlay of sensitivity analysis on SPOT Panchromatic image.

Your annotated model should look like the following example.

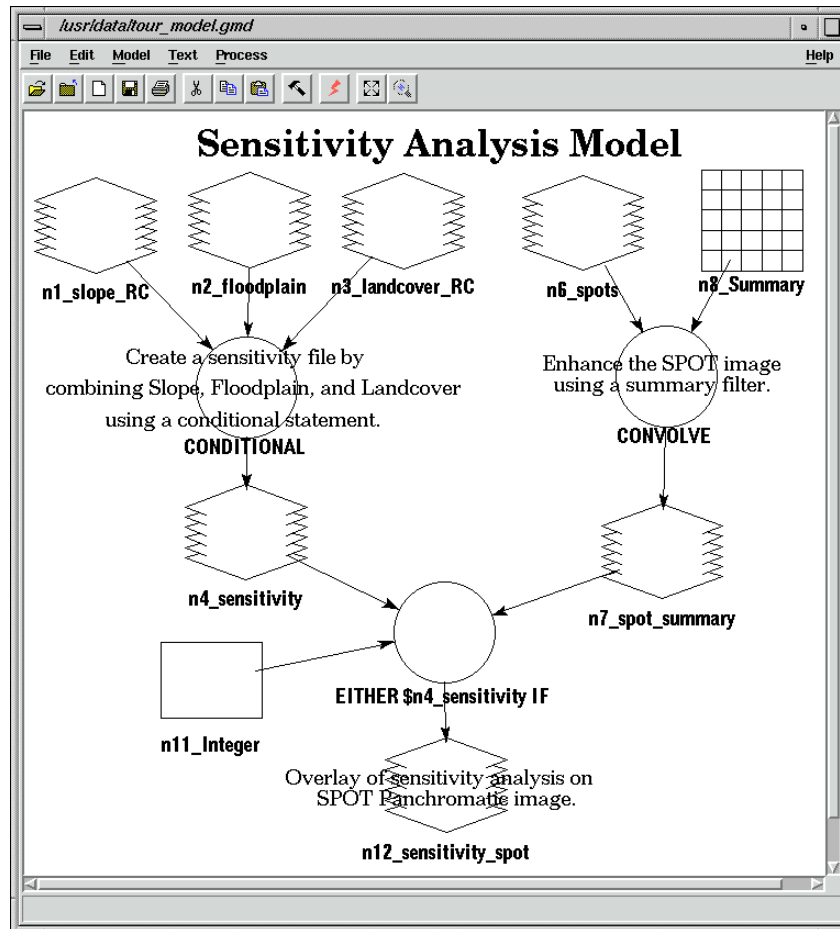

3. Save the model by selecting **File | Save** from the menu bar.

## Generate a Text Script

The graphical models created in Model Maker can be output to a script file (text) in SML. Select **Tools | Edit Text Files** from the ERDAS IMAGINE menu bar, and then edit these scripts using the SML syntax. Re-run or save the edited scripts in the script library.

SML is designed for advanced modeling, and encompasses all of the functions available in Model Maker, as well as:

- conditional branching and looping
- complex data types
- flexibility in using raster objects

To generate a script from a graphical model, follow these steps:



# Spatial Modeler

## Prepare

The graphical model must be open.

1. In the Model Maker viewer menu bar, select **Process | Generate Script**.

The Generate Script dialog opens.

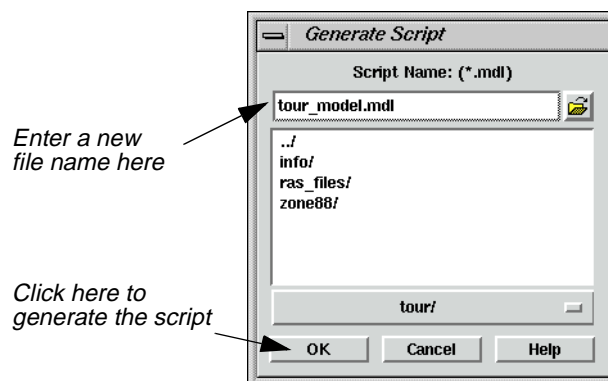

The **Script Name** defaults to the same root name as the graphical model. Scripts have the extension .mdl.

2. If you do not want to use the default, enter a new file name under **Script Name**.
3. Click **OK** to generate the script.

The model is now accessible from the **Model Librarian** option of Spatial Modeler.

4. From the ERDAS IMAGINE icon panel, click the Modeler icon.

The **Spatial Modeler** menu displays.

5. Select the **Model Librarian** option in the **Spatial Modeler** menu.

The Model Librarian dialog opens.

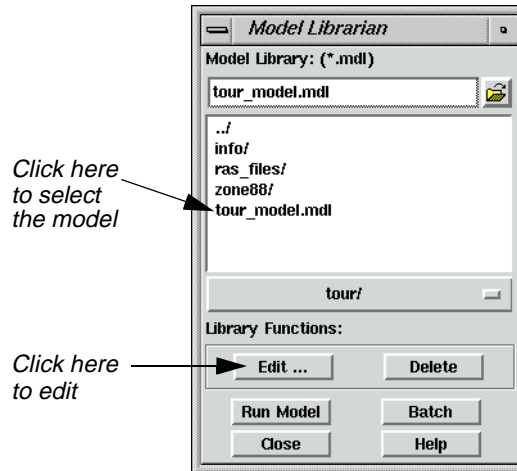

From this dialog you can edit, delete, or run script models.

6. Under **Model Library**, select the name you used for your model in step 2.
7. Click **Edit** in the Model Librarian dialog.

The model is displayed in the Text Editor, as in the following example:



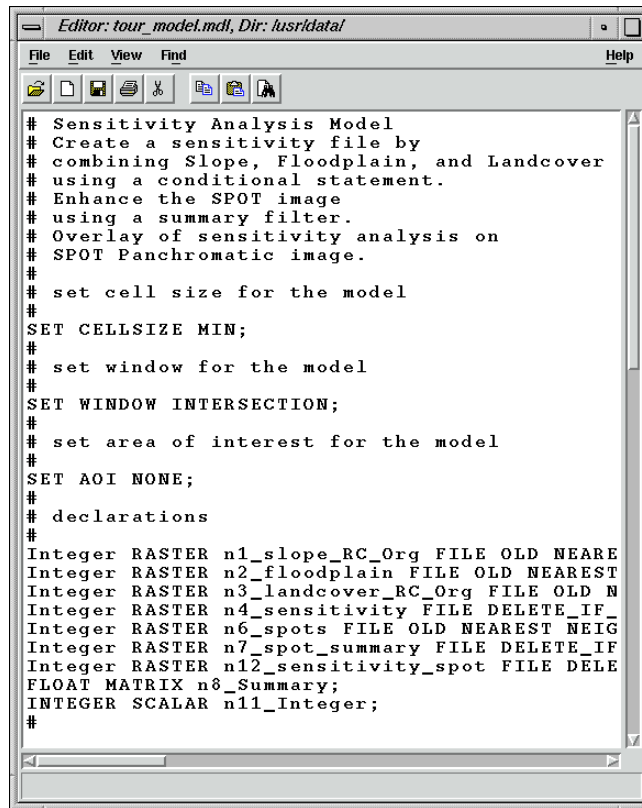

```
Editor: tour_model.mdl, Dir: iusr\data
File Edit View Find Help
# Sensitivity Analysis Model
# Create a sensitivity file by
# combining Slope, Floodplain, and Landcover
# using a conditional statement.
# Enhance the SPOT image
# using a summary filter.
# Overlay of sensitivity analysis on
# SPOT Panchromatic image.
#
# set cell size for the model
#
SET CELLSIZE MIN;
#
# set window for the model
#
SET WINDOW INTERSECTION;
#
# set area of interest for the model
#
SET AOI NONE;
#
# declarations
#
Integer RASTER n1_slope_RC_Org FILE OLD NEAREST
Integer RASTER n2_floodplain FILE OLD NEAREST
Integer RASTER n3_landcover_RC_Org FILE OLD NEAREST
Integer RASTER n4_sensitivity FILE DELETE_IF_EXISTS
Integer RASTER n6_spots FILE OLD NEAREST NEIGHBORHOOD
Integer RASTER n7_spot_summary FILE DELETE_IF_EXISTS
Integer RASTER n12_sensitivity_spot FILE DELETE_IF_EXISTS
FLOAT MATRIX n8_Summary;
INTEGER SCALAR n11_Integer;
#
```



*Annotation in scripts is located at the top of the file, in the order in which it was entered. If you want the annotation to be in the order of processing, annotate your graphical model from top to bottom.*

8. Select **File | Close** from the Text Editor menu bar.
9. Click **Close** in the Model Librarian dialog and the **Spatial Modeler** menu.

## Print the Model

You can output graphical models as ERDAS IMAGINE annotation files (.ovr extension) and as encapsulated PostScript files (.eps extension). You can also output directly to a PostScript printer.

### Prepare

You must have a graphical model open.

1. In the Model Maker viewer menu bar, select **File | Page Setup**.

The Page Setup dialog opens.



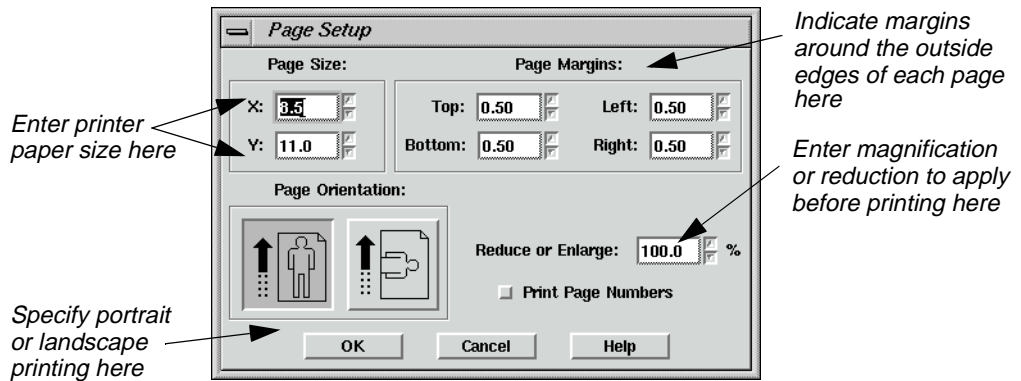

The default setting specifies a 8.5" × 11" page size. This is acceptable for most PostScript printers.

2. In the Page Setup dialog, adjust the size of the **Page Margins** to suit your preferences.
3. Click **OK**.
4. In the Model Maker viewer menu bar, select **File | Show Page Breaks**.

Dotted lines indicate page breaks according to the page size specified in the Page Setup dialog. You may have to use the scroll bars on the bottom and side of the Model Maker viewer to see these page breaks.

5. If your model takes up more than one page, you may want to rearrange it so that it fits on a single sheet.
6. In the Model Maker viewer tool bar, click the Print icon (or select **File | Print** from the Model Maker viewer menu bar).



The Print dialog opens.

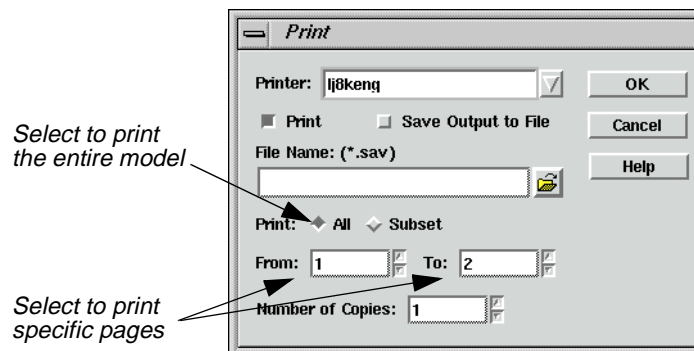

7. In the Print dialog, select the page(s) to print in the **From** and **To** boxes, or select **All** to print the entire model.

- Click **OK** to print the model.

## Apply the Criteria Function

The Criteria function in Model Maker simplifies the process of creating a conditional statement. In this example, you use data from a thematic raster layer and a continuous raster layer to create a new output layer. The input layers include a Landsat TM file and a slope file. This model performs similar to a parallelepiped classifier, but uses slope and image statistics in the decision process. The output file contains four classes: chaparral in gentle slopes, chaparral in steep slopes, riparian in gentle slopes, and riparian in steep slopes.



*For information on the parallelepiped classifier, see "CHAPTER 17: Advanced Classification" page 455.*

The model you create looks like this:

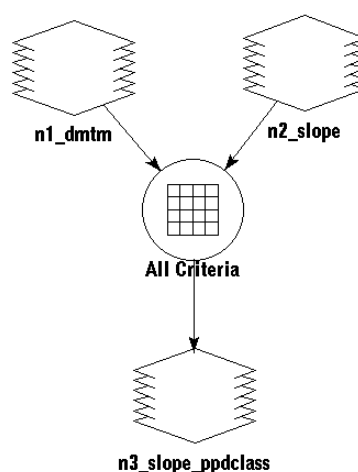

## Evaluate Training Samples

Before beginning, the ERDAS IMAGINE Classification tools were used to gather training samples of chaparral and riparian land cover. This was done to determine the minimum and maximum data file values of each class in three of the seven TM bands (4, 5, 3). These values are listed in the following table:

**Table 16-3: Training Samples of Chaparral and Riparian Land Cover**

Band	Chaparral		Riparian	
	Min	Max	Min	Max
4	31	67	55	92
5	30	61	57	87
3	23	37	27	40

Slopes below class value 3 are less than 8 percent, and therefore are characterized as gentle. Slopes in class value 3 or above are greater than 8 percent, and are characterized as steep. These values are used in the criteria function.

### Prepare

You must have Model Maker running, with a new Model Maker viewer displayed.

1. Click on the Raster icon in the Model Maker tool palette, then click the Lock icon.



2. Click three times in the Model Maker viewer to place the two input Raster graphics and the one output Raster graphic.
3. Click on the Criteria icon in the Model Maker tool palette.



4. Click in the Model Maker viewer to place the criteria graphic between the input and output Raster graphics.
5. Click on the Connect icon.



6. Connect the input Raster graphics to the criteria and the criteria to the output Raster graphic.
7. Click the Lock icon to disable the lock tool.
8. Click the Select icon.



# Spatial Modeler

## Define Input Raster Layers

1. Double-click the first Raster graphic in the Model Maker viewer.  
The Raster dialog opens.

2. In the Raster dialog, click on the Open icon under **File Name**.



The File Name dialog opens.

3. In the File Name dialog under **Filename**, select the file **dmtm.img** and click **OK**.
4. Click **OK** in the Raster dialog.

The Raster dialog closes and **n1\_dmtm** is written underneath the Raster graphic.

5. Double-click the second Raster graphic.

The Raster dialog opens.

6. In the Raster dialog, click on the Open icon under **File Name**.



The File Name dialog opens.

7. In the File Name dialog, select the file **slope.img** and click **OK**.
8. Click **OK** in the Raster dialog.

The Raster dialog closes and **n2\_slope** is written underneath the Raster graphic.

## Define Criteria

1. Double-click the Criteria graphic in the Model Maker viewer.  
The Criteria dialog opens.

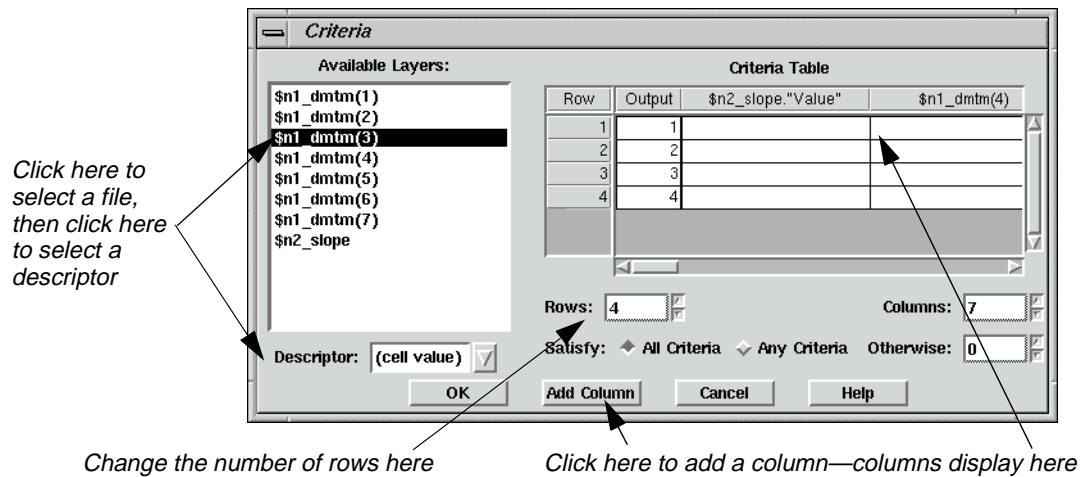

- In the Criteria dialog, click on **\$n2\_slope** under **Available Layers**.

The descriptor fields associated with that layer are now listed in the **Descriptor** popup list.

- Click on the **Descriptor** popup list to select the **Value** descriptor.

- Click **Add Column** to add that descriptor to the **Criteria Table**.

- Under **Available Layers**, click on **\$n1\_dmtm(4)**, then click **Add Column** to add a column for the minimum data file values in band 4.

- Click **Add Column** again to add a column for the maximum data file values in band 4.

- Repeat this procedure for **\$n1\_dmtm(5)** and **\$n1\_dmtm(3)**.

There are now eight columns in the **Criteria Table**.

- Change the number of **Rows** to **4**, because the final output file has four classes.

- Click in the first row of the **\$n2\_slope** column and type **<3**. Press Return on your keyboard.

- Under **\$n2\_slope**, enter **>=3** in row **2**, **<3** in row **3**, and **>=3** in row **4**.

- In the same manner, enter the minimum and maximum data file values for chaparral and riparian in the **Criteria Table**.

Rows **1** and **2** correspond to chaparral, and rows **3** and **4** correspond to riparian (see the chart on page 379).

The Criteria dialog should look like the one in the following diagram:



# Spatial Modeler

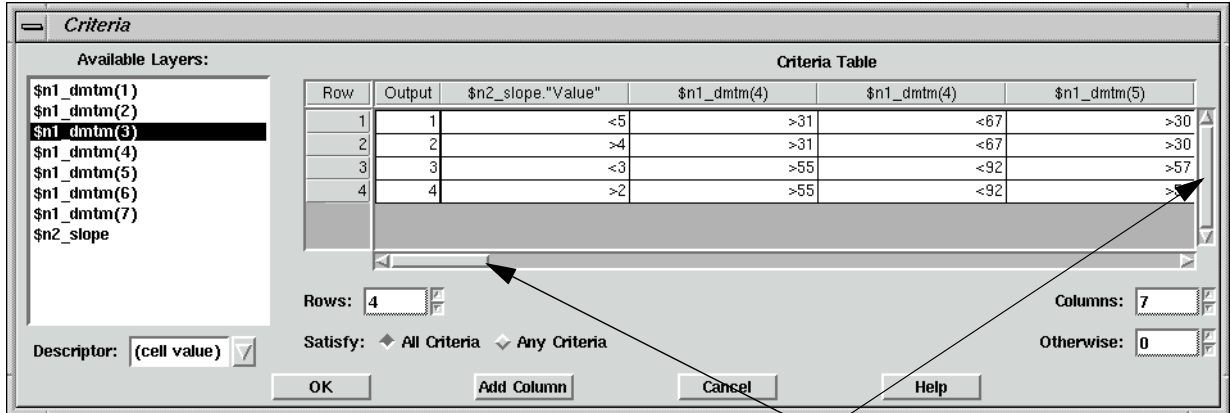

Use the scroll bars to view all columns

The complete **Criteria Table** should look similar to the following table:

**Table 16-4: Complete Criteria Table**

Row	\$n2_slope. "Value"	\$n1_dmtm(4)	\$n1_dmtm(4)	\$n1_dmtm(5)	\$n1_dmtm(5)	\$n1_dmtm(3)	\$n1_dmtm(3)
1	<3	>31	<67	>30	<61	>23	<37
2	>=3	>31	<67	>30	<61	>23	<37
3	<3	>55	<92	>57	<87	>27	<40
4	>=3	>55	<92	>57	<87	>27	<40

12. When all of the values are entered into the **Criteria Table**, click **OK**.

The Criteria dialog closes and **All Criteria** is written under the criteria graphic.

## Define Output Raster Layer

1. Double-click the output Raster graphic in the Model Maker viewer.

The Raster dialog opens.

2. In the Raster dialog under **File Name**, enter the name **slope\_ppdclass**, then Return on your keyboard.

Be sure that you specify a directory in which you have write permission.

3. Click on the **Delete if Exists** option.
4. Click on the **Data Type** popup list and select **Unsigned 4-bit**.
5. Confirm that **Thematic** is selected in the **File Type** popup list.

- Click **OK** in the Raster dialog.

The Raster dialog closes and **n3\_slope\_ppdclass** is written under the output Raster graphic.

- In the Model Maker viewer menu bar, select **Model | Set Window** to define the working window for the model.

The Set Window dialog opens.

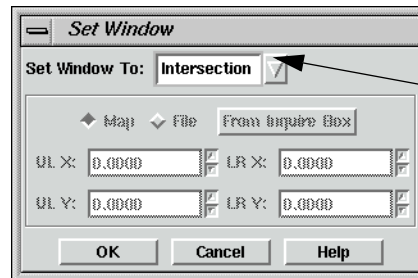

*Click on this popup list to select Intersection*

You want the model to work on the intersection of the input files. The default setting is the union of these files.

- In the Set Window dialog, click on the **Set Window To** popup list and select **Intersection**.
- Click **OK** in the Set Window dialog.

### Save the Model

- Click the Save icon or select **File | Save As** from the Model Maker viewer tool bar to save your model.



The Save Model dialog opens.

- In the Save Model dialog, enter a name for your model.  
Be sure you are saving the model in a directory in which you have write permission.
- Click **OK** in the Save Model dialog.
- In the Model Maker viewer tool bar, click the Run icon (or select **Process | Run** from the Model Maker viewer menu bar) to run the model.



# Spatial Modeler



While the model runs, a Job Status dialog opens, reporting the status of the model.

5. When the model is finished, click **OK** in the Job Status dialog.
6. If you like, display **slope\_ppdclass.img** in a Viewer to view the output image of your model.

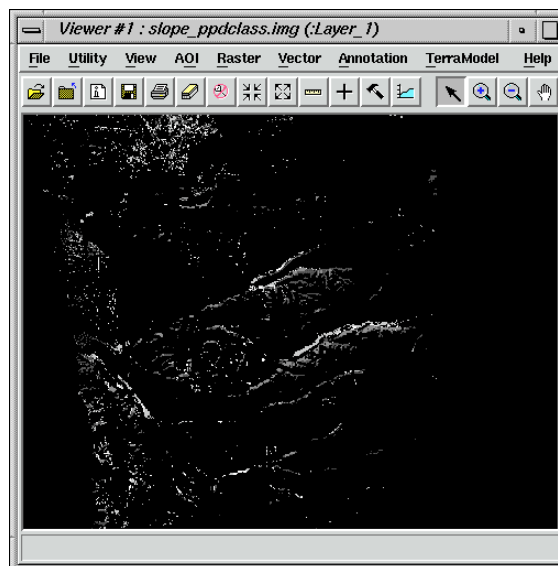

The image displays in gray scale. The class values are defined in the criteria function where: 1—chaparral in gentle slopes, 2—chaparral in steep slopes, 3—riparian in gentle slopes, and 4—riparian in steep slopes.



---

*For more information about the Spatial Modeler, see "APPENDIX A: Additional Information" on page 595.*

---

## Minimizing Temporary Disk Usage

The Spatial Modeler attempts to perform operations in memory where possible, but there are some common operations that produce temporary files. Any time a Global operation is performed on an intermediate result, a temporary file is produced. For example, if the Global Maximum pixel value is required for an image being calculated, nothing other than an estimate may be produced without actually generating the image.

If an intermediate image is going to be used in two or more additional functions in a model, a temporary file is created. Also if nonpoint functions like Spread and Clump are performed on intermediate results, or if their results are used in further processes, temporary files are created.



There are two types of temporary files created by Spatial Modeler: temporary files, which are declared as such; and intermediate files, which get created due to the mix of operations. The amount of space required by temporary files can be controlled to some degree by user preferences. By default, Spatial Modeler is shipped to maintain the highest degree of precision at the expense of disk space. The default data type for both temporary and intermediate files is double precision floating point, which uses 8 bytes to store a pixel value. Depending on your needs, you can cut the size of your temporary files in half.

### Set Preferences

1. Select **Session | Preferences** from the ERDAS IMAGINE menu bar.
2. In the Preference Editor, select the **Spatial Modeler** category.
3. Set **Float Temp Type** to **Single Precision Float**.
4. Set **Float Intermediate Type** to **Single Precision Float**.

Spatial Modeler, by default, also does not constrain the area your model processes, so temporary files extend to the union of all your input images. If, for example, you are doing an operation on two input images and your results are only valid in areas where both images exist, then setting the following preference may significantly reduce your temporary space requirements:

5. Set **Window Rule** to **Intersection**.

Also to ensure the temporary files get created on a disk drive where space is available, check the following preference:

6. In the Preference Editor, select the **User Interface & Session** category.
7. Set the **Temporary File Directory** to a local disk with sufficient free space.

In some cases, you may be able to adequately predict the output data range of a calculation. For example, if you calculate NDVI within your model, you know that at most, it can range from -0.5 to 0.5. In this case, you could

- store the result as floating point, taking at least 4 bytes per pixel, or
- scale the results to 0-255 in order to store the result as unsigned 8-bit data, taking just 1 byte per pixel. In this case since you know the range, you can re-scale the data by simply adding 0.5 then multiplying by 255, without the need for any temporary files.



---

*For more extensive examples of how models may be written without the use of temporary disk space use Model Maker to open: 8bit\_pca.gmd and 8bit\_res\_merge.gmd in the <IMAGINE\_HOME>/etc/models directory, where <IMAGINE\_HOME> is the location of ERDAS IMAGINE on your system.*



---

## Making Your Models Usable by Others

### Prompt User

When you specify specific input rasters or vectors in your model, their complete path is stored in the model. The same is true when you specify output files. So, to give someone else your models, they need to redefine all the inputs and outputs.

Starting with ERDAS IMAGINE 8.3, inputs and outputs can be set to **Prompt User** so that no absolute paths are contained in the model. The model, in turn, may easily be shared without the need to redefine any inputs or outputs.

### Providing a User Interface to Your Model

Another method of producing a model that can not only be easily shared with others, but is also very easy to run, is to write an EML front-end to your model.

#### Prepare

You must have ERDAS IMAGINE running.

1. Click the Modeler icon on the ERDAS IMAGINE icon panel.



The **Spatial Modeler** menu opens.

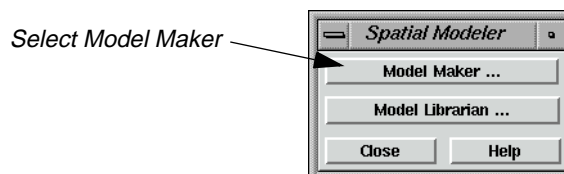

2. Click **Model Maker** on the **Spatial Modeler** menu.

A blank Spatial Modeler viewer opens along with the Model Maker tool palette.

#### Open an Existing Model

1. Select **File | Open** or click on the Open Existing Model icon in the tool bar.



The Load Model dialog opens.

## Making Your Models Usable by Others

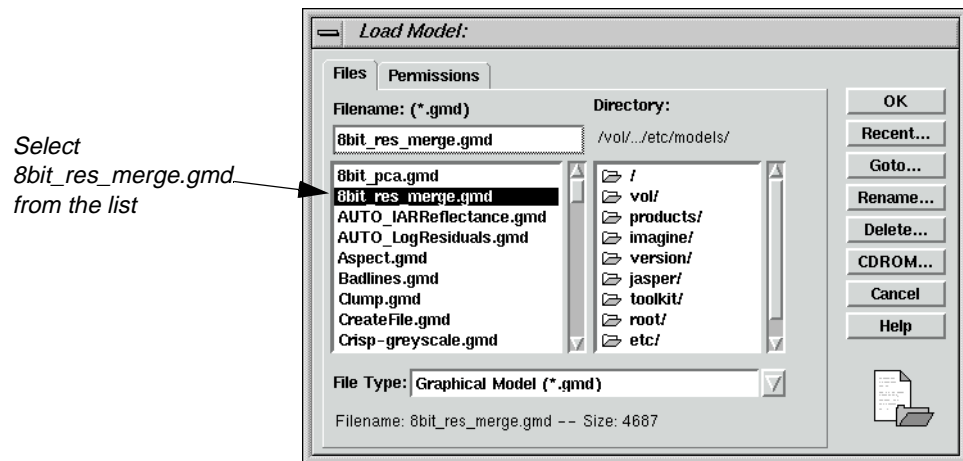

2. Select **8bit\_res\_merge.gmd** in the Load Model dialog, and click **OK**.

The model opens in the Spatial Modeler viewer.

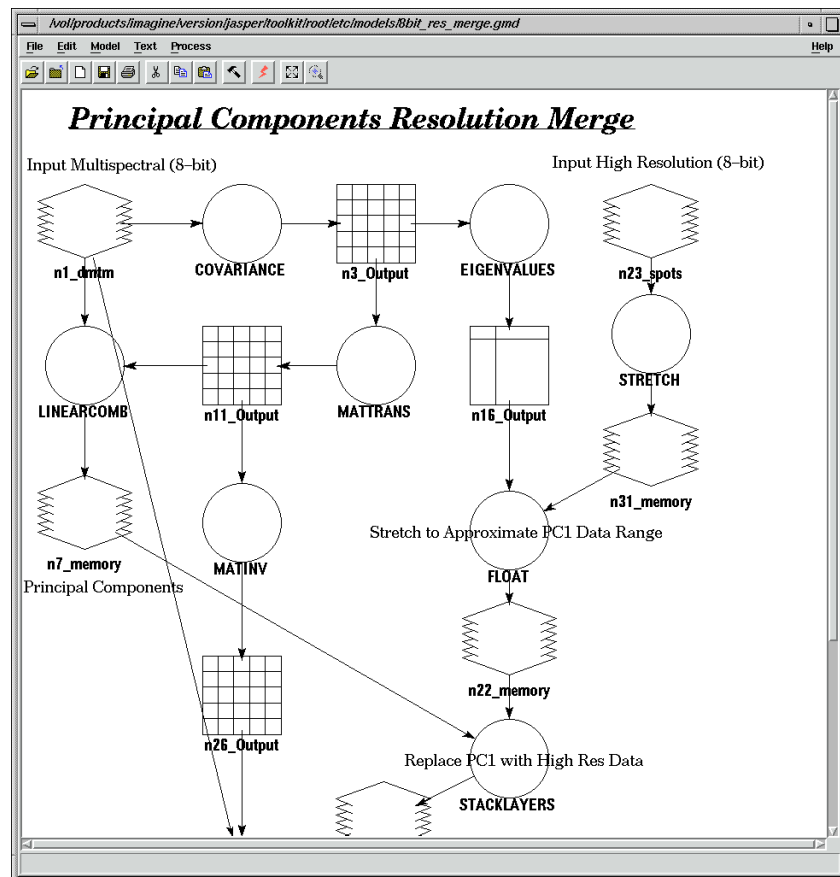

3. Select **Process | Generate Script**.

The Generate Script dialog opens.



# Spatial Modeler

4. Click the Open icon in the Generate Script dialog, and navigate to a directory where you have write permission.



5. Name the file **8bit\_res\_merge.mdl**, then click **OK** in the dialog.

*Save the .mdl file in a location where you have writer permission—you can then edit the file*

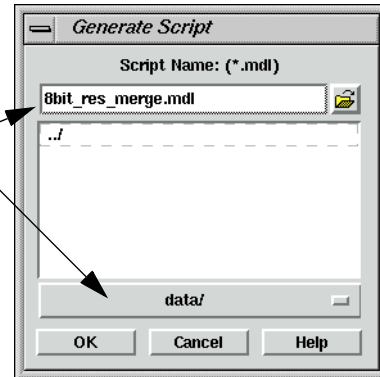

*Remember where you saved the file. You use it again on page 393.*

6. Click **OK** in the Generate Script dialog.

## Edit the Model

1. In the **Spatial Modeler** menu, click on **Model Librarian**.
2. Navigate to the directory in which you saved **8bit\_res\_merge.mdl**, and select it.

*Select the model from your writable directory*

*Click Edit to make changes to the model*

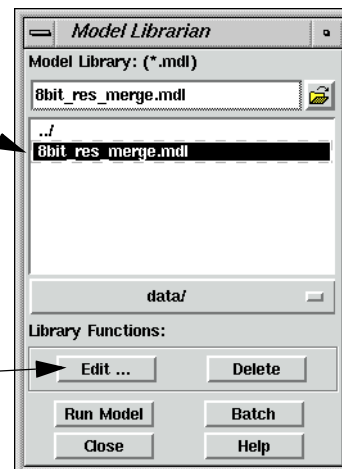

3. Click on the **Edit** button in the Model Librarian dialog.

The following SML script is displayed in the Editor:

```
# Principal Components Resolution Merge
# Input Multispectral (8-bit)
# Principal Components
# Replace PC1 with High Res Data
# Inverse PC
# Output Merged Image (8-bit)
# Input High Resolution (8-bit)
# Stretch to Approximate PC1 Data Range
#
# set cell size for the model
#
SET CELLSIZE MIN;
#
# set window for the model
#
SET WINDOW INTERSECTION;
#
# set area of interest for the model
#
SET AOI NONE;
#
# declarations
#
Float RASTER n1_dmtm FILE OLD NEAREST NEIGHBOR AOI NONE
"$IMAGINE_HOME/examples/dmtm.img";
Integer RASTER n23_spots FILE OLD NEAREST NEIGHBOR AOI NONE
"$IMAGINE_HOME/examples/spots.img";
Integer RASTER n29_merge_small FILE DELETE_IF_EXISTING IGNORE
0 ATHEMATIC 8 BIT UNSIGNED INTEGER
"c:/temp/merge_small.img";
FLOAT MATRIX n3_Output;
FLOAT MATRIX n11_Output;
FLOAT MATRIX n26_Output;
FLOAT TABLE n16_Output;
{
#
# function definitions
#
#define n31_memory Float(STRETCH ($n23_spots(1) , 3 , 0 , 255 ))
n3_Output = COVARIANCE ( $n1_dmtm );
n11_Output = MATTRANS ( EIGENMATRIX ($n3_Output) );
n26_Output = MATINV ( $n11_Output ) ;
#define n7_memory Float(LINEARCOMB ( $n1_dmtm - GLOBAL MEAN (
```



## Spatial Modeler

```
                                $n1_dmtm ) , $n11_Output ) )
n16_Output = EIGENVALUES ( $n3_Output ) ;
#define n22_memory Float(FLOAT((( $n31_memory - 127.5) * 3 *
                                (SQRT($n16_Output[0])) / 127.5))
#define n38_memory Float(STACKLAYERS($n22_memory ,
                                $n7_memory(2: NUMLAYERS ($n7_memory)))
n29_merge_small = LINEARCOMB ( $n38_memory , $n26_Output ) +
                                GLOBAL MEAN ( $n1_dmtm ) ;
}
QUIT;
```

4. Locate “**\$IMAGINE\_HOME/examples/dmtm.img**” (in bold above) on line 24 and change it to **arg1**.
5. Locate “**\$IMAGINE\_HOME/examples/spots.img**” (in bold above) on line 25 and change it to **arg2**.
6. Locate “**c:/temp/merge\_small.img**” (in bold above) on line 26 and change it to **arg3**.

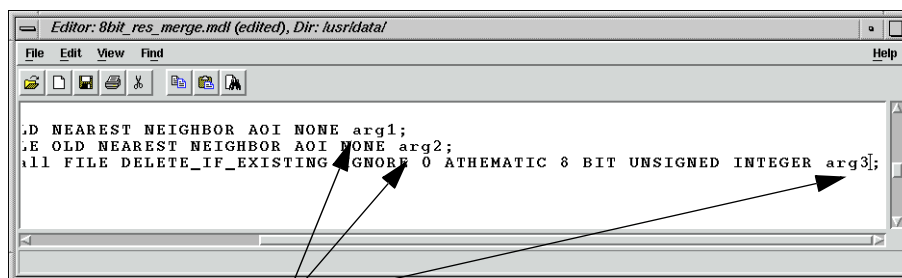

*The code now has arg1, arg2, and arg3*

7. Select **File | Save**, or click on the Save Current Document icon in the Editor.



### Edit the EML

1. Select **File | New**, or click on the New icon in the Editor.



2. Select **File | Open**, or click on the Open icon.



3. In the Load File dialog, type **\*.eml** for the **File Name** and press Return on your keyboard.

This searches for EML scripts in the directory.

4. Select **8bit\_res\_merge.eml**, and click **OK** in the Load File directory.



---

*The .eml file is located in <IMAGINE\_HOME>/scripts, where <IMAGINE\_HOME> is the location of ERDAS IMAGINE on your system.*

The following EML script displays in the Editor:

```
component res_merge {  
  frame res_merge {  
    title "Resolution Merge";  
    geometry 140,120,250,230;  
    statusbar;  
    filename hi_res_pan;  
    filename outputname;  
    button ok;  
    filename multi_spec {  
      title above center "Multispectral File:";  
      info "Select the multispectral input file.";  
      shortform;  
      geometry 0,10,245,49;  
      select getpref ("eml" "default_data_path")+ "/*.img";  
    }  
  }  
}
```



```
filetypedef "raster";
on input {
if (($multi_spec != "") & ($hi_res_pan != "") &
($outputname != "")) { enable ok;
}
else
{
disable ok;
}
}
}

filename hi_res_pan {
title above center "High Resolution Pan File:";
info "Select the high resolution pan input file.";
shortform;
geometry 0,70,245,49;
select getpref ("eml" "default_data_path")+/*.img";
filetypedef "raster";
on input {
if (($multi_spec != "") & ($hi_res_pan != "") &
($outputname != "")) { enable ok;
}
else
{
disable ok;
}
}
}

filename outputname {
title above center "Output File:"; info "Select output file.";
shortform;
geometry 0,130,245,49;
select getpref ("eml" "default_output_path")+/*.img";
filetypedef "raster" pseudotypes off creatable on;
newfile;
on input {
if (($multi_spec != "") & ($hi_res_pan != "") &
($outputname != "")) { enable ok;
}
else
{
disable ok;
}
}
}

button ok {
title "OK";
info "Accept all info and issue the job.";
```



```
geometry 35,190,82,25;
on mousedown {
  disable ok;
  job modeler -nq
    "d:/erdas/models/8bit_res_merge.mdl"
    -meter
    -state
    quote($multi_spec)
    quote($hi_res_pan)
    quote($outputname)
  ;
  unload;
}
}

button cancel {
  title "Cancel";
  info "Cancel this process, do not run the job.";
  geometry 140,190,82,25;
  on mousedown {
    unload ;
  }
}

on framedisplay {
  disable ok;
}

}

on startup {
  display res_merge;
}
}
```

5. Locate **"d:/erdas/models/8bit\_res\_merge.mdl"** (in bold above) on line 74, and change it to the location and name of the script you generated.



# Spatial Modeler

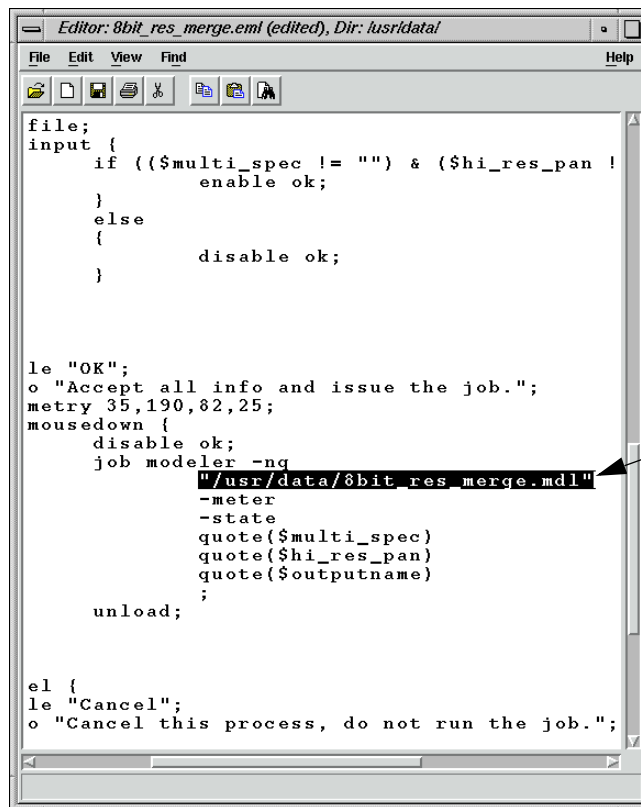

Change this section of the code to reflect the location of the .mdl file you edited with arg1, arg2, and arg3

6. Select **File | Save As**.

Save the .eml file with a new name in a directory where you have write permission

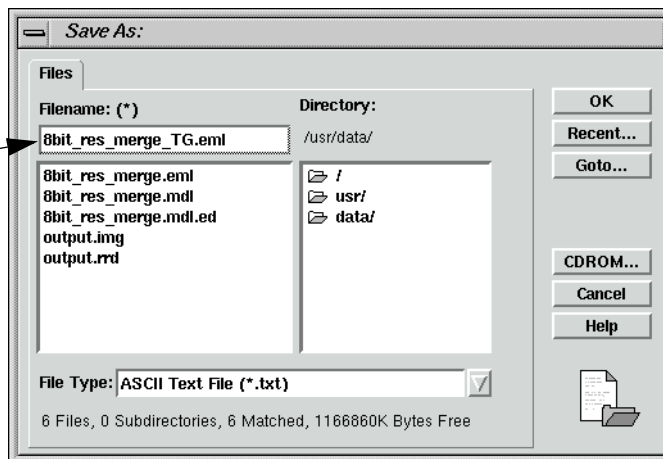

7. In the Save As dialog, navigate to a directory where you have write permission.
8. Save the .eml file as **8bit\_res\_merge\_TG.eml**, then click **OK** in the Save As dialog.

## Set Session Commands

1. On the ERDAS IMAGINE menu bar select **Session | Commands**.



The Session Command dialog opens.

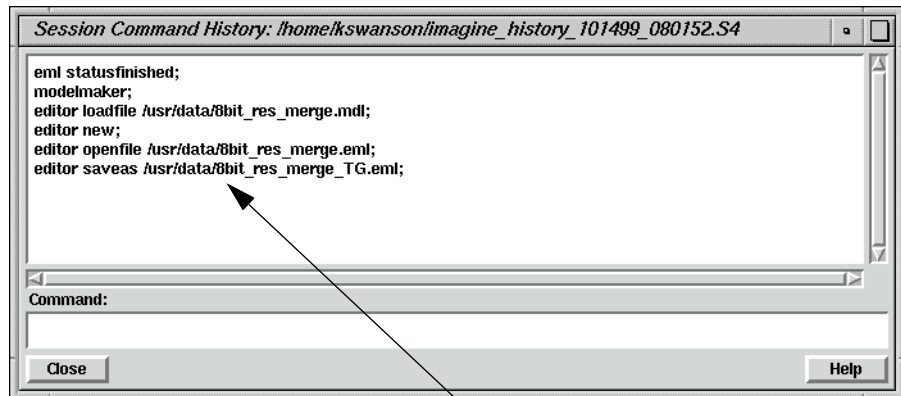

*Your most recent commands are listed here*

2. In the **Command** field enter the following command (replacing the directory with the one you chose).

```
load "c:/temp/8bit_res_merge.eml"
```

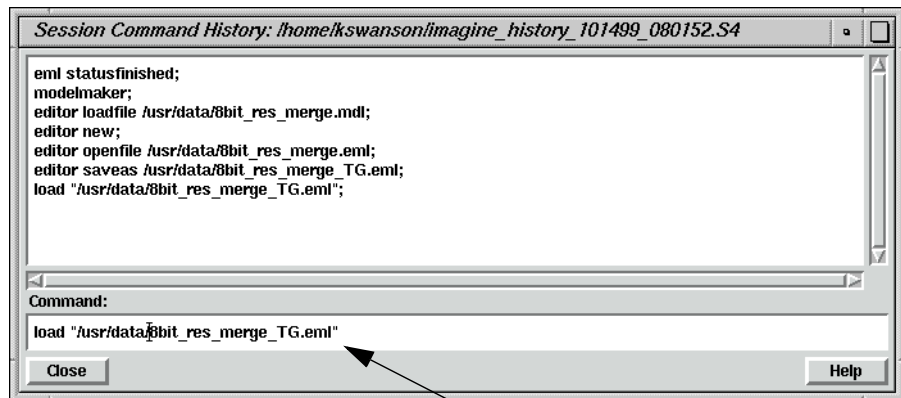

*Type the load command, plus the location of the .eml file here to execute the model*

3. Press Return on your keyboard.

The following dialog displays:



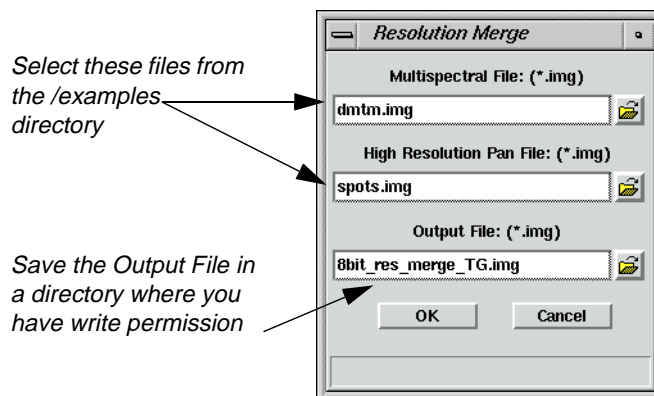

4. For the **Multispectral File**, select **dmtm.img** from the /examples directory.



The file **dmtm.img** is located in the <IMAGINE\_HOME>/examples directory, where <IMAGINE\_HOME> is the location of ERDAS IMAGINE on your system.

5. For the **High Resolution Pan File**, select **spots.img** from the examples directory.
6. For the **Output File**, select a directory in which you have write permission, and enter the name **8bit\_res\_merge\_TG.img**, then press Return on your keyboard.
7. Click **OK**.

A Job Status dialog opens, tracking the progress.

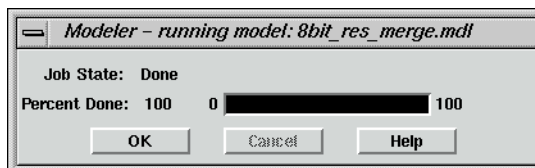

8. When the job is 100% complete, click **OK** in the dialog.



You can set the **Keep Job Status Box** in the **User Interface & Session** category of the Preference Editor so that the Job Status box is dismissed automatically after an operation is performed.

### Check the Results

1. In the ERDAS IMAGINE icon panel, click the Viewer icon.



2. Click the Open icon, and navigate to the directory in which you saved the **Output File** you just created, **8bit\_res\_merge\_TG.img**



3. Click **OK** in the Select Layer To Add dialog to add the file.

The image displays in the Viewer.

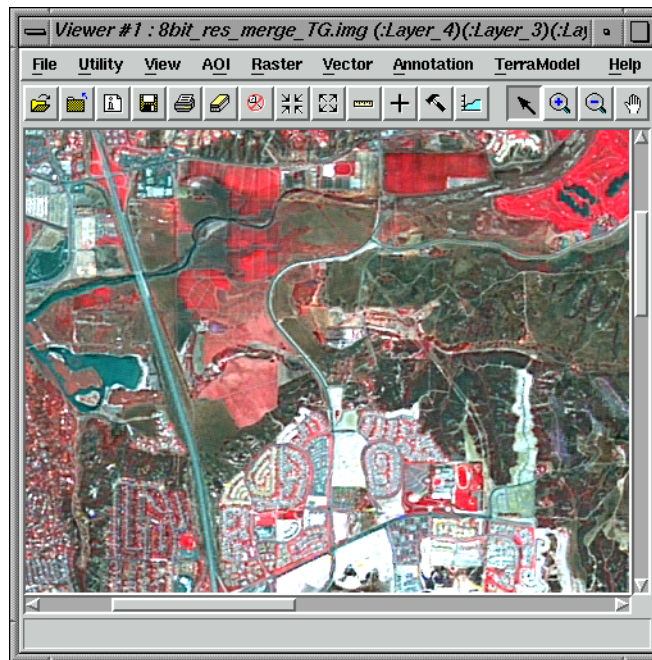

4. Click the Open icon, and navigate to the /examples directory.
5. Select the file **dmtm.img** from the list, then click the **Raster Options** tab.
6. Deselect the **Clear Display** option.
7. Click **OK** in the Select Layer To Add dialog.

The multispectral file, **dmtm.img**, lends the color to the resulting file:  
**8bit\_res\_merge\_TG.img**.



# Spatial Modeler

## Use the Swipe Utility

1. From the Viewer menu bar, select **Utility | Swipe**.
2. Move the slider bar back and forth to see how the two images compare.
3. When you are finished, close the Swipe utility.

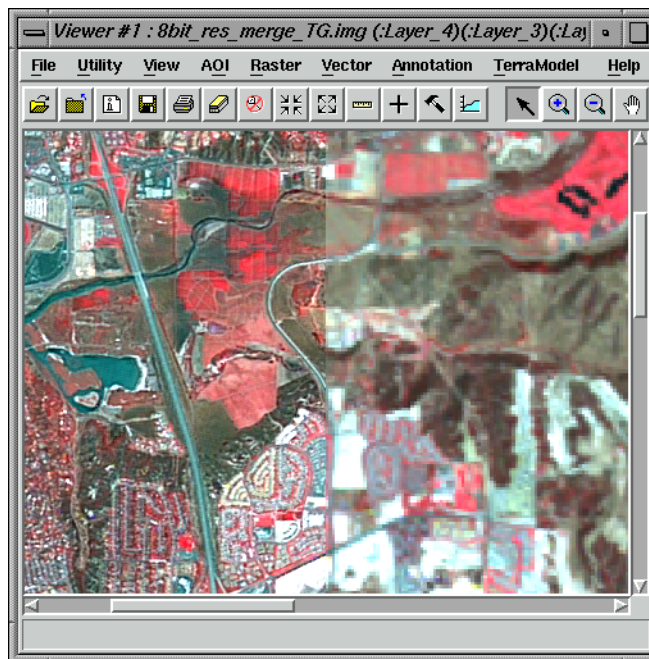

## Check the spots.img image

The panchromatic image, **spot.img**, is the image that lends the detail to the image you created: **8bit\_res\_merge\_TG.img**.

1. Click the Viewer icon on the ERDAS IMAGINE icon panel to open a new Viewer.
2. Click the Open icon, and navigate to the /examples directory in the Select Layer To Add dialog.
3. Select the file **spots.img**, then click **OK** in the Select Layer To Add dialog.

The file **spots.img** displays in the Viewer. Note the detail in the image.

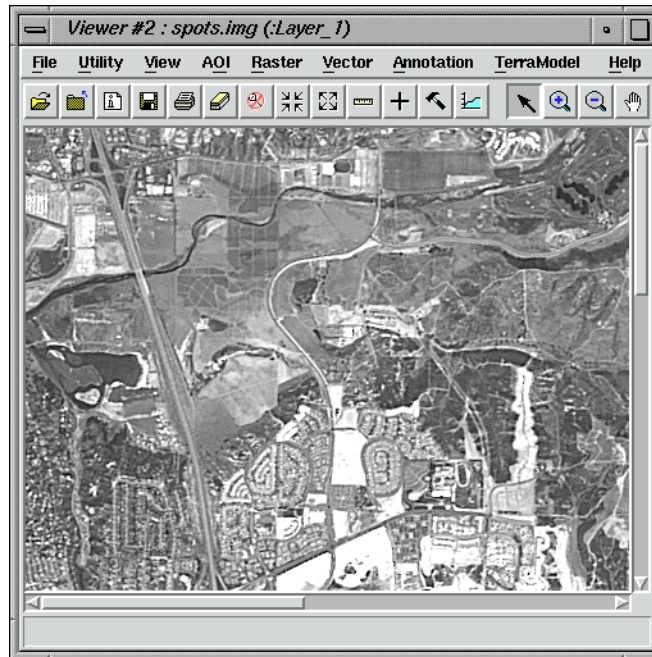

4. When you are finished evaluating the images, select **Session | Close All Viewers** from the ERDAS IMAGINE menu bar.
5. Close the editors.
6. Save changes to your .eml file, **8bit\_res\_merge\_TG.eml**.
7. Close the .gmd file, do not save changes.

---

### Using Vector Layers in Your Model

Vector layers may be used in several different ways within models. All processing is done in raster format. However, converting the vector layers to raster is done on the fly at either a default resolution or one specified to meet the level of detail required by the application.

#### Vector Layers as a Mask

One simple application of vector layers is to use polygonal boundaries to cookie-cut your imagery. Whether the polygons represent political boundaries, ownership boundaries, zoning, or study area boundaries, they may be used to limit your analysis to just the portions of the imagery of interest.

In the following example you use a vector coverage to not just cookie-cut an image but to generate an output image for visual presentation that highlights the study area. Inside the study area, you enhance the image, while outside the study area you blur the image to further distinguish the study area.



# Spatial Modeler

## Prepare

You must have ERDAS IMAGINE running.

1. Click the Modeler icon on the ERDAS IMAGINE icon panel.



The **Spatial Modeler** menu opens.

Select Model Maker

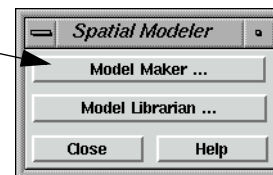

2. Click on the **Model Maker** button in the **Spatial Modeler** menu.

A blank Model Maker viewer opens along with tools.

## Set up the Model

1. Click on the Raster icon in the Model Maker tool palette.



2. Click near the top center of the Model Maker viewer.
3. Click on the Matrix icon in the Model Maker tool palette.



4. Click to the left of the Raster object in the Model Maker viewer.
5. Click on the Matrix icon again in the Model Maker tool palette.
6. Click to the right of the Raster object in the Model Maker viewer.



## Using Vector Layers in Your Model

7. Click on the Function icon in the Model Maker tool palette.



8. Click below and to the left of the Raster object in the Model Maker viewer.
9. Click on the Function icon again in the Model Maker tool palette.
10. Click below and to the right of the Raster object in the Model Maker viewer.
11. Click on the Raster icon in the Model Maker tool palette.
12. Click below the first Function object in the Model Maker viewer.
13. Click on the Raster icon again in the Model Maker tool palette.
14. Click below the second Function object in the Model Maker viewer.
15. Click on the Function icon in the Model Maker tool palette.
16. Click below and between the Raster objects just placed in the Model Maker viewer.
17. Click on the Vector icon in the Model Maker tool palette.



18. Click to the left of the Function object just placed in the Model Maker viewer.
19. Click on the Raster icon in the Model Maker tool palette.
20. Click to the right of the Function object just placed in the Model Maker viewer.



# Spatial Modeler

21. Using the Connection tool, and optionally the Lock tool, connect the objects in the model as depicted in the following picture:



When you are finished, the model looks like the following:

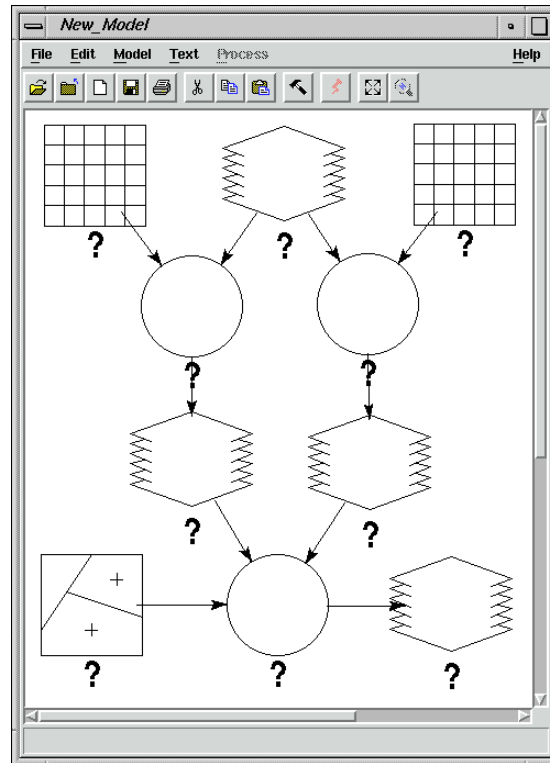

## Add Matrix Properties

1. Make sure the Selector tool is active.



2. Double-click the top left Matrix object in the Model Maker viewer.

The Matrix Definition and Matrix dialogs open.

## Using Vector Layers in Your Model

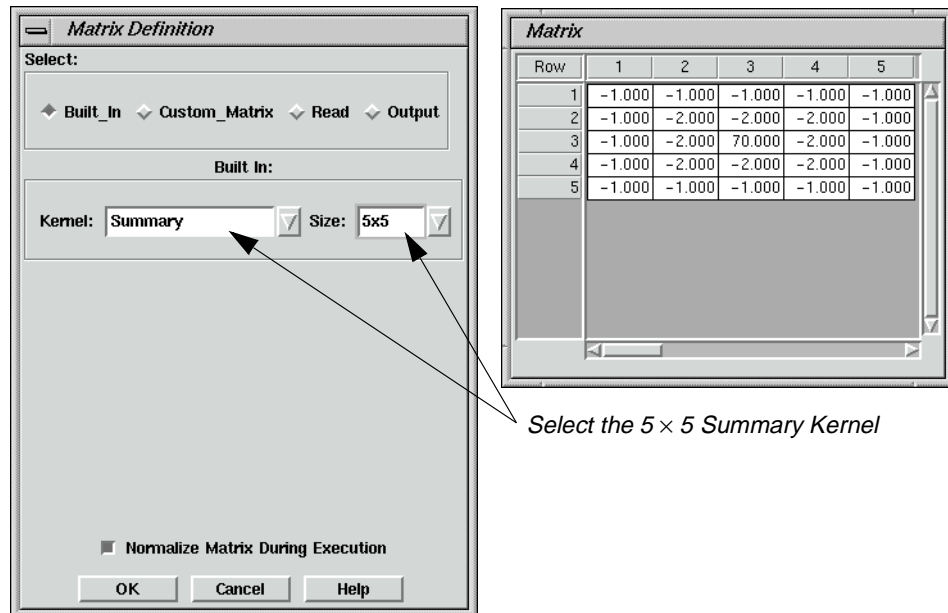

3. Using the **Kernel** popup list select **Summary**.
4. Using the **Size** popup list select **5x5**.
5. Click the **OK** button in the Matrix Definition dialog.

### Add Raster Properties

1. Double-click the top Raster object in the Model Maker viewer.

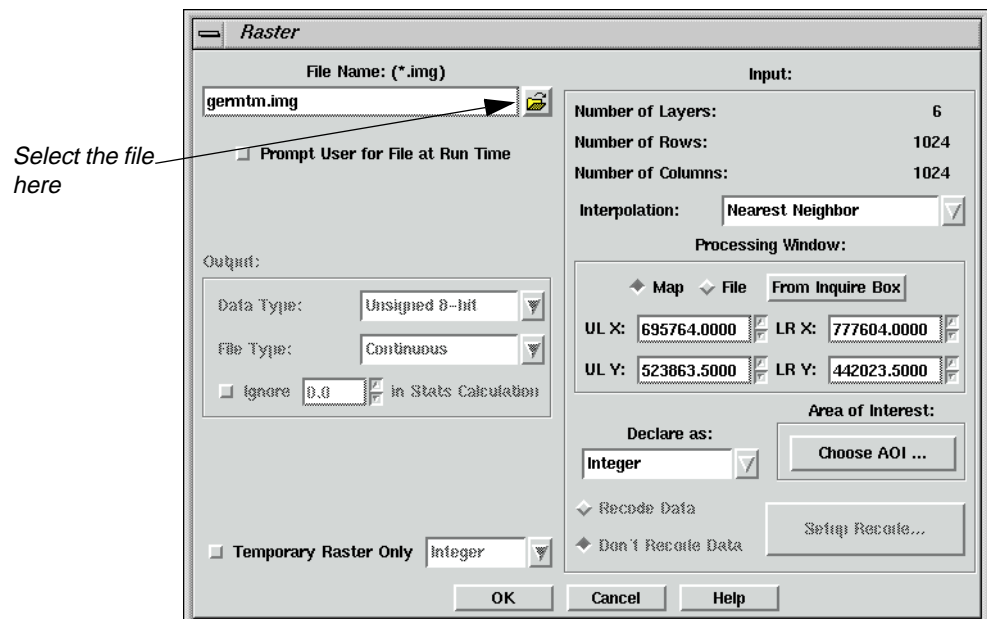

# Spatial Modeler

2. Click the Open icon to open the File Name dialog.



3. Select **germtm.img** from the examples directory, and click **OK** in the File Name dialog.
4. Click **OK** in the Raster dialog to accept the file **germtm.img**.

## Add Matrix Properties

1. Double-click the top right Matrix object in the Model Maker viewer.
2. Verify that **Low Pass** is selected in the **Kernel** popup list.
3. Using the **Size** popup list select **7x7**.
4. Click the **OK** button in the Matrix Definition dialog.

## Add Function Properties

1. Double-click the left Function object.

The Function Definition dialog opens.

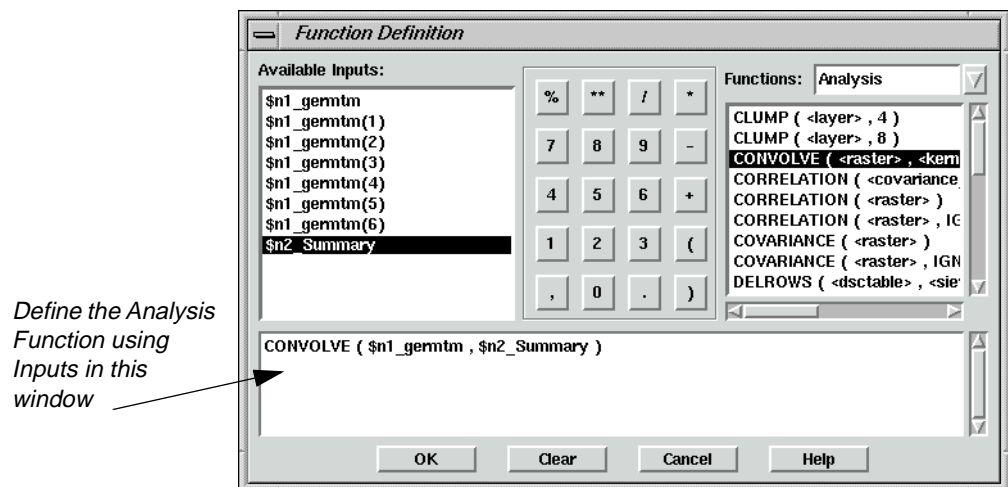

2. From the Analysis Functions select **CONVOLVE ( <raster> , <kernel> )**, this should be the third item on the list.
3. In the lower portion of the Function Definition dialog, click in the middle of **<raster>**.
4. Under Available Inputs, click on **\$n1\_germtm**.
5. In the lower portion of the Function Definition dialog, click in the middle of **<kernel>**.
6. Under Available Inputs, click on **\$n2\_Summary**.

7. Click **OK** in the Function Definition dialog.

### Add Function Properties

1. Double-click the right Function object.
2. From the Analysis Functions select **CONVOLVE ( <raster> , <kernel> )**, this should be the third item on the list.
3. In the lower portion of the Function Definition dialog, click in the middle of **<raster>**.
4. Under Available Inputs, click on **\$n1\_germtm**.
5. In the lower portion of the Function Definition dialog, click in the middle of **<kernel>**.
6. Under Available Inputs, click on **\$n3\_Low\_Pass**.

Your function string should look like the following:

```
CONVOLVE ( $n1_germtm , $n3_Low_Pass )
```

7. Click **OK** in the Function Definition dialog.

### Add Raster Properties

1. Double-click the Raster object that is output from the Function on the left.

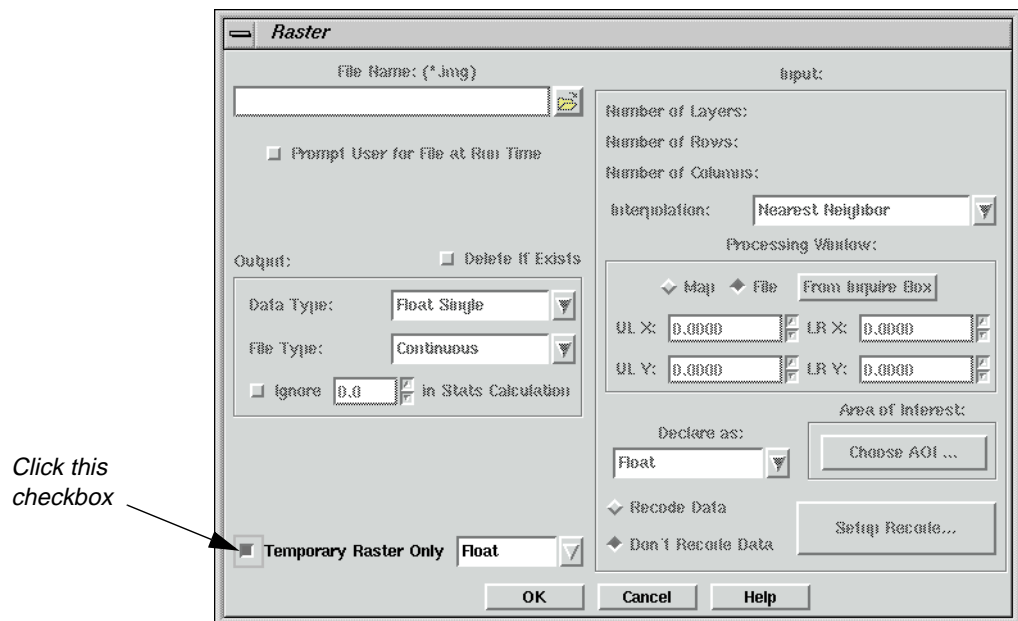

2. In the lower left corner of the dialog click the checkbox **Temporary Raster Only**.
3. Click **OK** in the Raster dialog.



# Spatial Modeler

## Add Raster Properties

1. Double-click the Raster object that is output from the Function on the right.
2. In the lower left corner of the dialog click the checkbox **Temporary Raster Only**.
3. Click **OK** in the Raster dialog.

## Add Vector Properties

1. Double-click the Vector object in the lower left corner of the model.

The Vector dialog opens.

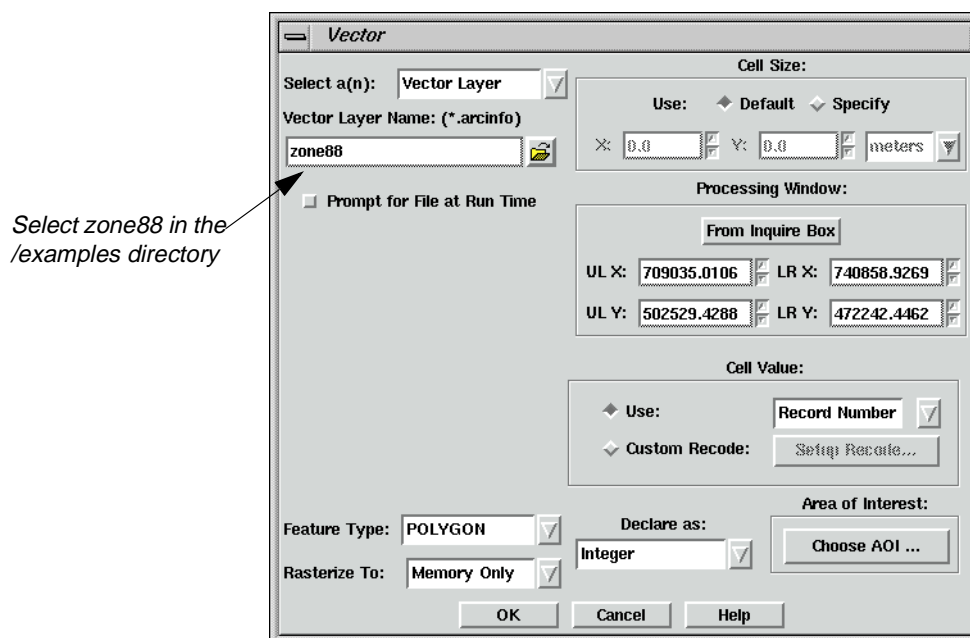

2. Click the Open icon under **Vector Layer Name**.



3. In the Vector Layer Name dialog, navigate to the /examples directory, and select **zone88**.
4. Click **OK** in the Vector Layer Name dialog.
5. Click **OK** in the Vector dialog to accept the **Vector Layer Name**.

## Add Function Properties

1. Double-click the final Function object.

The Function Definition dialog opens.

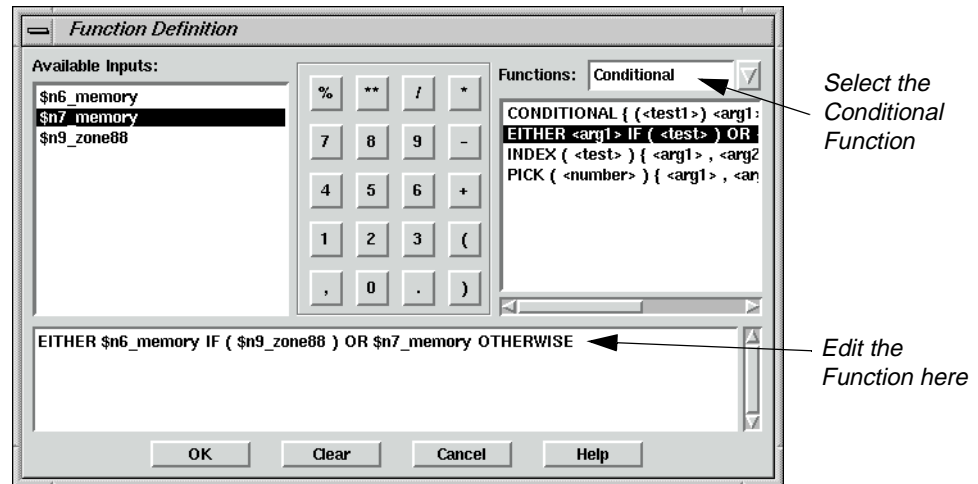

2. In the **Functions** popup list, select **Conditional**.
3. In the list of **Functions**, select **EITHER <arg1> IF ( <test> ) OR <arg2> OTHERWISE**, this should be the second item on the list.
4. In the lower portion of the Function Definition dialog, click in the middle of **<arg1>**.
5. Under **Available Inputs**, click on **\$n6\_memory**.
6. In the lower portion of the Function Definition dialog, click in the middle of **<test>**.
7. Under **Available Inputs**, click on **\$n9\_zone88**.
8. In the lower portion of the Function Definition dialog, click in the middle of **<arg2>**.
9. Under **Available Inputs**, click on **\$n7\_memory**.
10. Click **OK** in the Function Definition dialog.

### Add Raster Properties

1. Double-click the final output Raster object.

The Raster dialog opens.



## Spatial Modeler

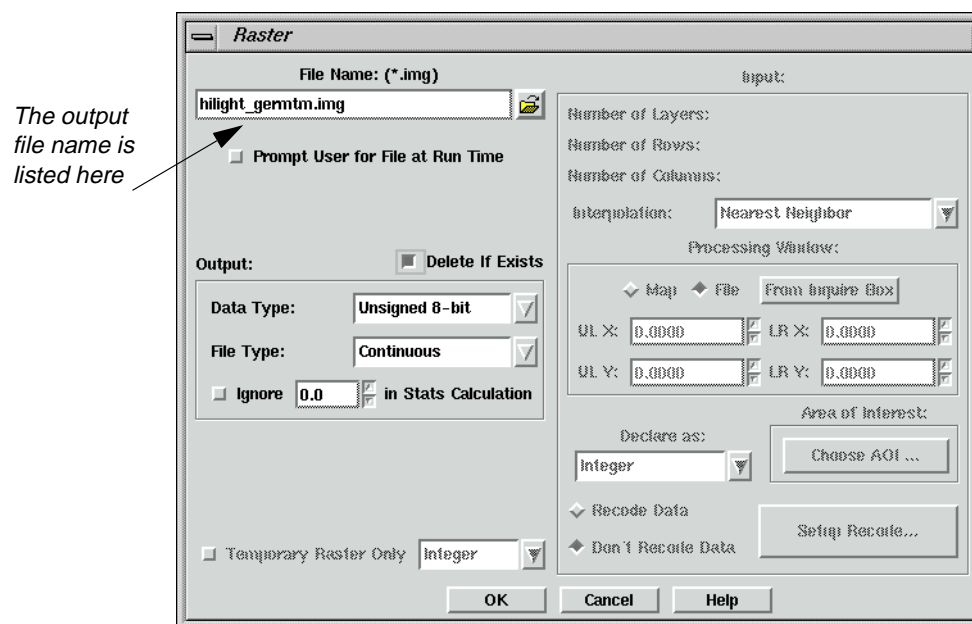

2. Click the Open icon and navigate to a directory where you have write permission.
3. In the **Filename** section of the File Name dialog, type **highlight\_germtm.img** for the output image name, then click **OK** in the File Name dialog.
4. Click on **Delete If Exists** checkbox.
5. Click on the **OK** button in the Raster dialog.



## Using Vector Layers in Your Model

Your completed model should like the following:

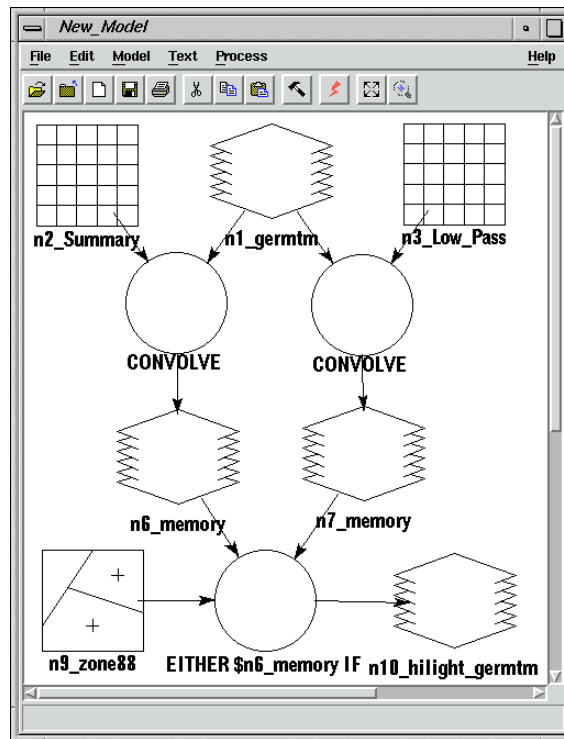

### Execute the Model and Check Results

1. Select **Process | Run**, or click on the Execute the Model icon in the tool bar.



A Job Status dialog opens tracking the progress of the function.

2. Click **OK** in the Job Status dialog when it reaches 100% complete.

Next, use the Viewer to examine your output image and locate the highlighted area.

3. Click the Viewer icon in the ERDAS IMAGINE icon bar.



4. Click the Open icon and navigate to the directory in which you saved the output file, **highlight\_germtm.img**, then click **OK** in the dialog to display the file.



# Spatial Modeler

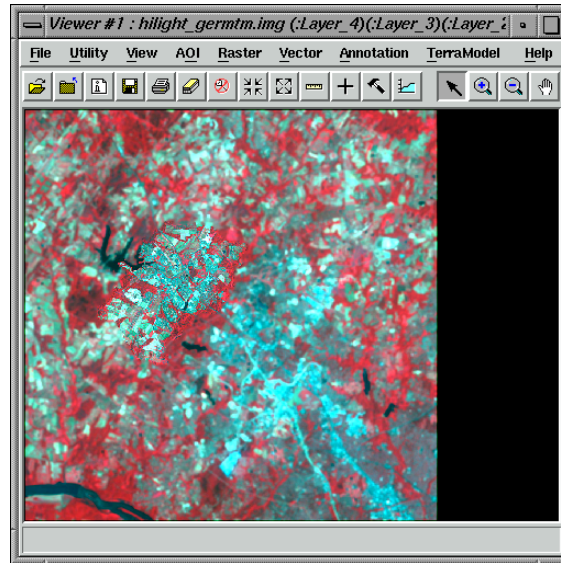

5. Use the Zoom In tool to view the highlighted area.



Notice that the area you emphasized with the model is sharp, while the area surrounding it is fuzzy.

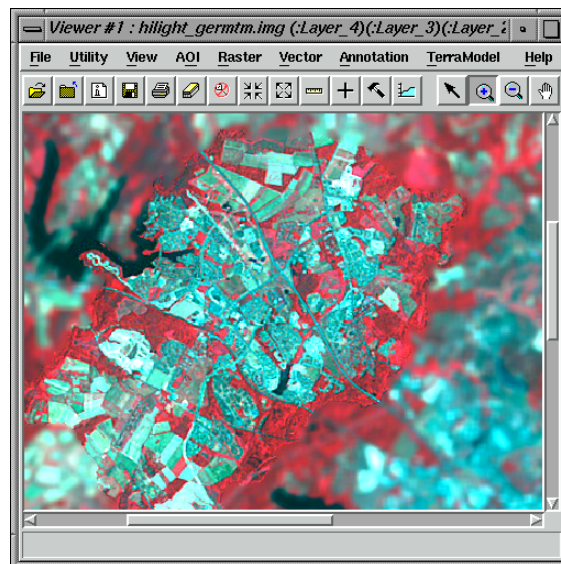

6. When you are finished viewing the image select **File | Close** from the Viewer menu bar.

### Add Attributes to Vector Layers

Another application of using vector layers in models is to calculate summary information about your imagery for each polygon in a vector layer. This summary information can then be stored as an additional attribute of the vector layer.

#### Prepare

You must have ERDAS IMAGINE running.

#### Copy Vector Layers

1. Click the Vector icon on the ERDAS IMAGINE icon bar.



The **Vector Utilities** menu opens.

*Click Copy Vector Layer*

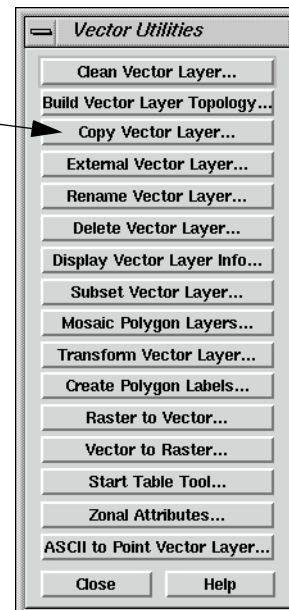

1. Click the **Copy Vector Layer** button on the **Vector Utilities** menu.

The Copy Vector Layer dialog opens.



# Spatial Modeler

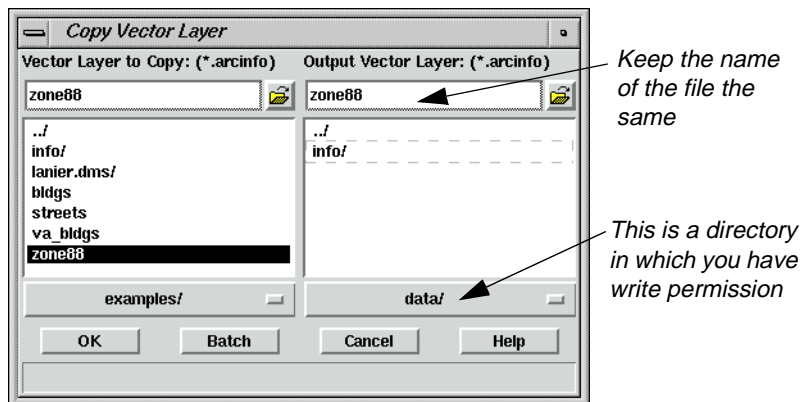

2. In the **Vector Layer to Copy** section, navigate to the <IMAGE\_HOME>/examples directory, and select **zone88**.
3. In the **Output Vector Layer** section, navigate to a directory where you have write permission.
4. Type the name **zone88**, then press Enter on your keyboard.
5. Click **OK** in the Copy Vector Layer dialog.  
A Job Status dialog opens tracking the progress.
6. When the job is finished, click **OK** in the Job Status dialog.
7. Click **Close** in the **Vector Utilities** menu.

## Set up the Model

1. Click the Modeler icon on the ERDAS IMAGINE icon panel.



The **Spatial Modeler** menu opens.

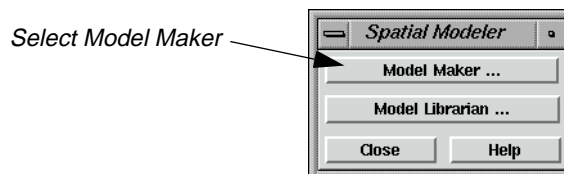

2. Click on the **Model Maker** button in the **Spatial Modeler** menu.  
A blank Model Maker viewer opens along with the tools.
3. Click on the Raster icon in the Model Maker tool palette.

## Using Vector Layers in Your Model



4. Click near the upper left corner of the Model Maker viewer.
5. Click on the Vector icon in the Model Maker tool palette.



6. Click to the right of the Raster object in the Model Maker viewer.
7. Click on the Function icon in the Model Maker tool palette.



8. Click below and between the Raster and the Vector objects in the Model Maker viewer.
9. Click on the Table icon in the Model Maker tool palette.



10. Click below the Function object in the Model Maker viewer.
11. Using the Connection tool, and optionally the Lock tool, connect the Raster object and the Vector object to the Function object as inputs.



12. Using the Connection tool, connect the Function object to the output Table object.

When you are finished, the model looks like the following:



# Spatial Modeler

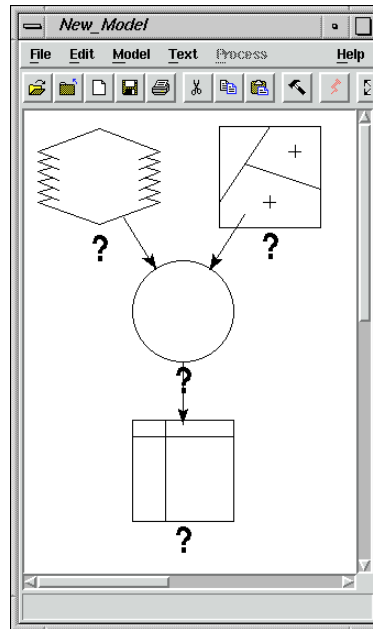

## Add Raster Properties

1. Confirm the Selector tool is active.



2. Double-click the Raster object.
3. In the Raster dialog, click the Open icon to open the File Name dialog.
4. Select **germtm.img** from the /examples directory and click **OK** in the File Name dialog.
5. Click **OK** in the Raster dialog to accept the file **germtm.img**.

## Add Vector Properties

1. Double-click the Vector object.

The Vector dialog opens.

## Using Vector Layers in Your Model

Select the file from the directory in which you copied it

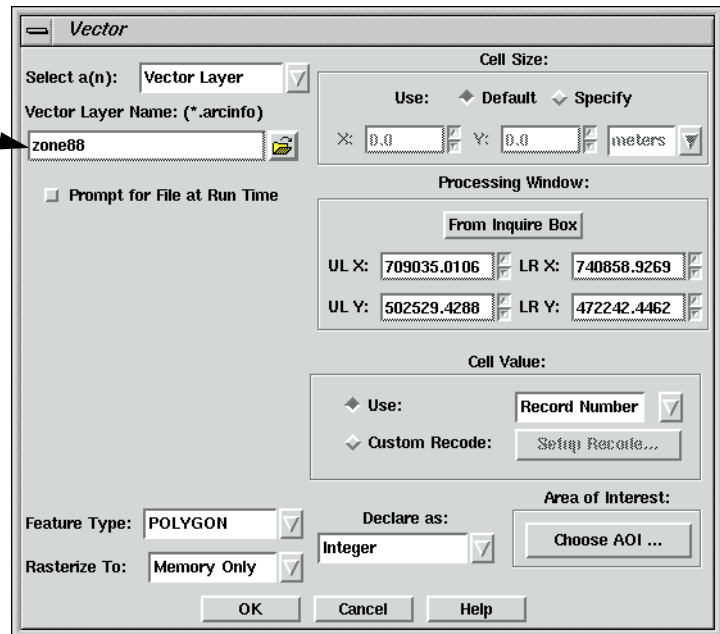

2. Click the Open icon to open the Vector Layer Name dialog.
3. Select the copy of **zone88** you made earlier, and click **OK** in the Vector Layer Name dialog.
4. Click **OK** in the Vector dialog.

### Add Function Properties

1. Double-click the Function object.

The Function Definition dialog opens.

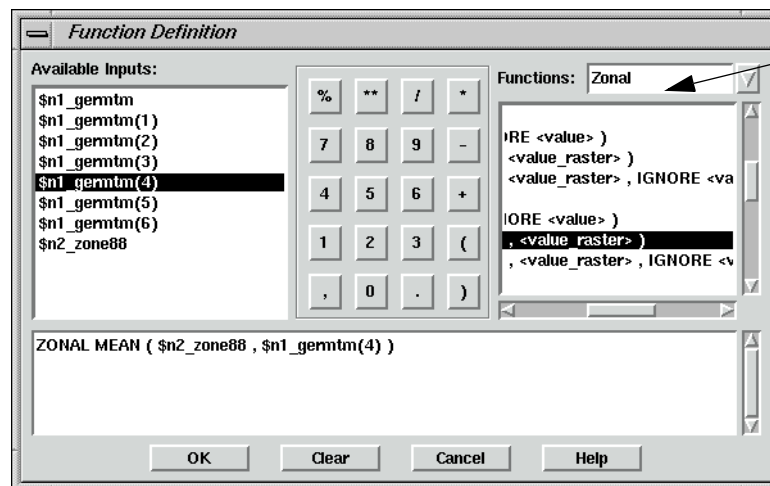

Choose the Zonal Function

2. In the **Functions** popup list, select **Zonal**.



## Spatial Modeler

3. In the list of **Functions**, select **ZONAL MEAN ( <zone\_raster> , <value\_raster> )**, this should be the sixteenth item on the list.
4. In the lower portion of the Function Definition dialog, click in the middle of **<zone\_raster>**.
5. Under **Available Inputs**, click on **\$n2\_zone88**.
6. In the lower portion of the Function Definition dialog, click in the middle of **<value\_raster>**.
7. Under **Available Inputs**, click on **\$n1\_germtm(4)**.
8. Click on the **OK** button in the Function Definition dialog.

### Add Table Properties

1. Double-click the Table object.  
The Table Definition dialog opens.
2. Verify that **Output** is selected.
3. Under the **Output Options**, click on the **Output to Descriptor or Attribute** checkbox.
4. For the **Existing Layer Type** popup list, select **Vector Layer**.
5. For **File**, select the copy of **zone88** from the directory in which you saved it earlier.
6. Since we are computing a new attribute, for **Attribute**, type **MEAN-NIR**.
7. The **Data Type** popup list should now be enabled, so select **Float**.





## Using Vector Layers in Your Model

The Table Definition dialog should look as follows:

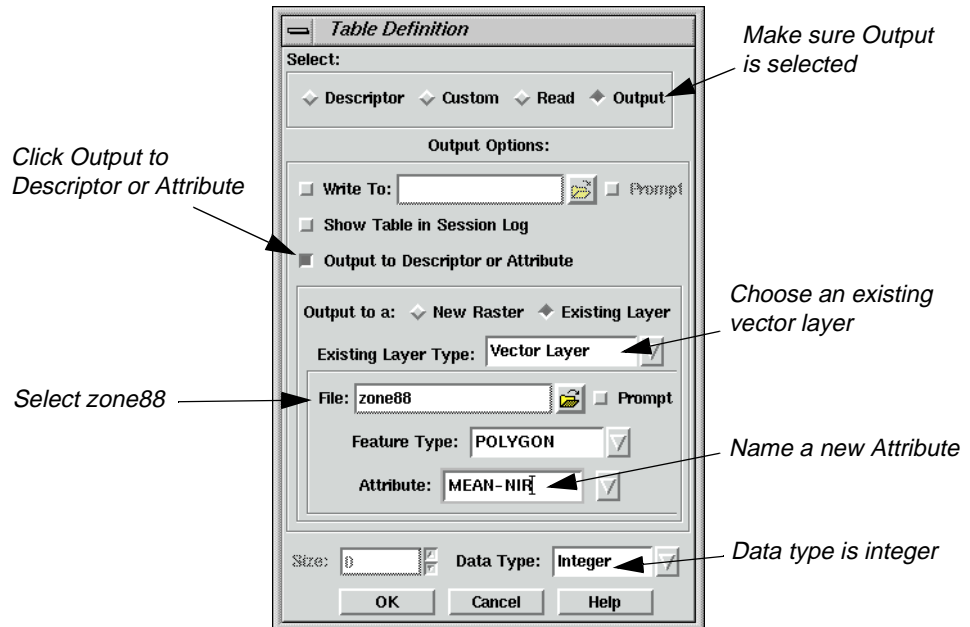

8. Click **OK** in the Table Definition dialog.

Your model should now look like the following:

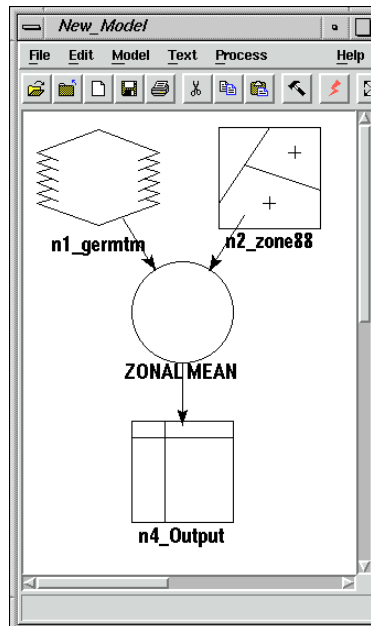

### Execute the Model and Check the Results

1. Select **Process | Run**, or click on the Execute the Model icon in the tool bar.

# Spatial Modeler



2. When the Job Status dialog is 100% complete, click **OK**.
3. Click the Viewer icon in the ERDAS IMAGINE icon bar.



4. In the Viewer, select **Open | Vector Layer** from the **File** menu.
5. In the Select Layer To Add dialog, select the copy of **zone88** you created and click **OK**.
6. From the Viewer's **Vector** menu select **Attributes**.
7. In the Attribute CellArray, scroll to the right to see the newly created **MEAN-NIR** field.

The values in this column represents the mean pixel value from band 4 (near infrared) of **germtm.img** for each of the polygons in **zone88**.

---

## Debug Your Model

Model Maker facilitates creating a model to accomplish your task, but it may still take some effort to get your model running successfully. Model Maker works hand in hand with Modeler.

Model Maker is used to create models graphically. To execute these models, Model Maker creates an SML script, which it hands off to Modeler for execution. Modeler does all of the syntax and error checking, so finding an error in your model is not a single step operation. The following exercises demonstrate some of the common errors encountered in building new models.

## Eliminate Incomplete Definition

In building a model, Model Maker provides prototypes for function arguments to be replaced with actual arguments. In this exercise, you see what happens if you forget to replace a prototype.

### Prepare

You must have ERDAS IMAGINE running.

1. Click the Modeler icon on the ERDAS IMAGINE icon panel.



The **Spatial Modeler** menu opens.

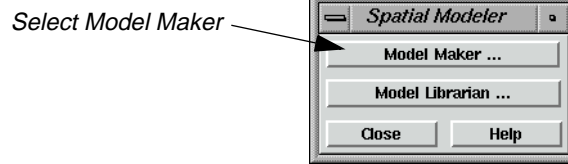

2. Click **Model Maker** on the **Spatial Modeler** menu.

A blank Spatial Modeler viewer opens along with the Model Maker tool palette.

### Create the Model

1. Click on the Raster icon in the Model Maker tool palette.



2. Click to place a Raster object in the upper left corner of the Model Maker viewer.
3. Click on the Matrix icon in the Model Maker tool palette.



4. Click to place the Matrix object to the right of the Raster object in the Model Maker viewer.
5. Click on the Function icon in the Model Maker tool palette.



6. Click to place the Function object below and centered between the Raster object and the Matrix object in the Model Maker viewer.
7. Click on the Raster icon in the Model Maker tool palette.
8. Click to place the Raster object below the Function object in the Model Maker viewer.
9. Click on the Connection icon in the Model Maker tool palette.



10. Click on the Lock icon in the Model Maker tool palette. It changes to reflect the locked state.



11. Connect the first Raster object and the Matrix object to the Function object as inputs.



# Spatial Modeler

12. Connect the Function object to the final Raster object as an output.
13. Click on the Selector icon in the Model Maker tool palette.



14. Click on the Lock icon in the Model Maker tool palette to turn it off.

Your model now looks like the following:

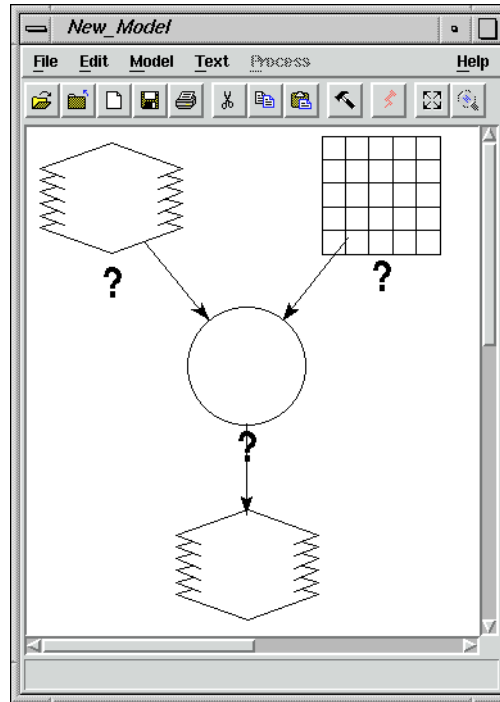

## Add Raster Properties

1. Double-click the first Raster object.

The Raster dialog opens.

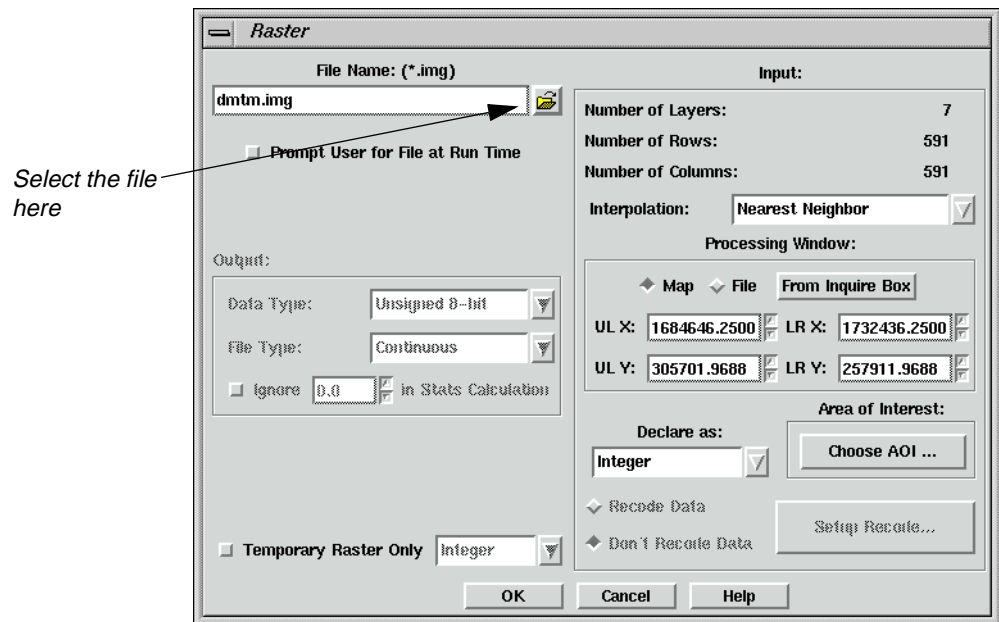

2. Click the Open icon in the Raster dialog to open the File Name dialog.



3. In the File Name dialog, select the file **dmtm.img** from the /examples directory.



The file **dmtm.img** is located in <IMAGINE\_HOME>/examples, where <IMAGINE\_HOME> is the location of ERDAS IMAGINE on your system.

4. Click **OK** in the File Name dialog.

The Raster dialog updates with the appropriate **File Name**.

5. Click **OK** in the Raster dialog.

### Add Matrix Properties

1. In the Model Maker viewer, double-click the Matrix object.

The Matrix Definition dialog opens.



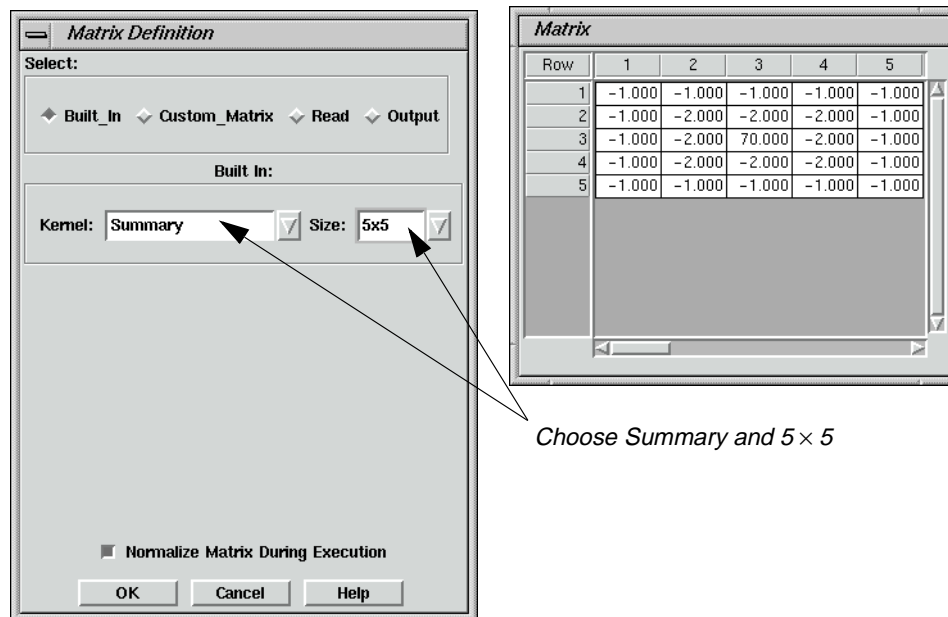

2. From the **Kernel** list, select **Summary**.
3. From the **Size** list, select **5 × 5**.
4. Click **OK** in the Matrix Definition dialog.

## Add Function Properties

1. Double-click the Function object.

The Function Definition dialog opens.

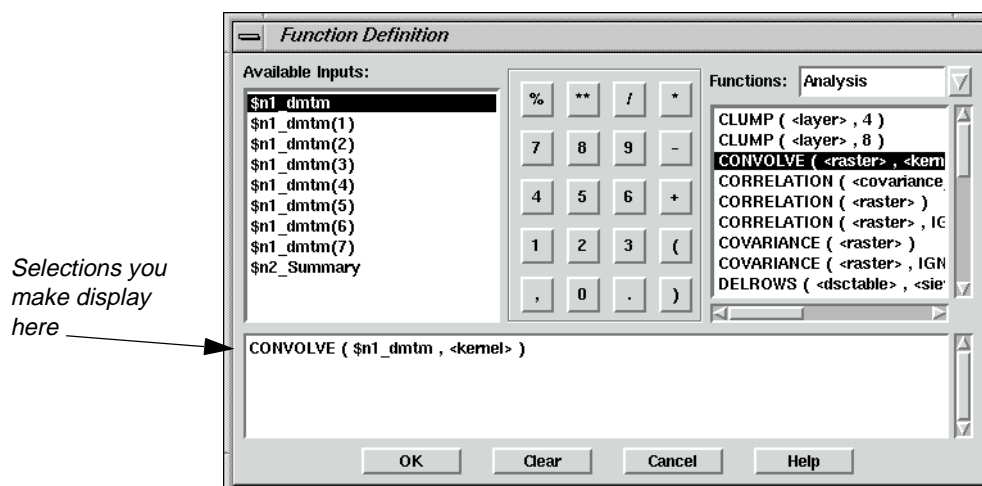

2. Confirm that the **Functions** dropdown list shows **Analysis**.
3. Under **Functions**, select **CONVOLVE ( <raster> , <kernel> )**.
4. In the lower portion of the Function Definition dialog, click in the middle of **<raster>**.
5. Under **Available Inputs**, click on **\$n1\_dmtm**.

At this point you would normally replace the **<kernel>** prototype, but you are going to intentionally forget to do that.

6. Click the **OK** button.

### Add Raster Properties

1. Double-click the output Raster object.

The Raster dialog opens.

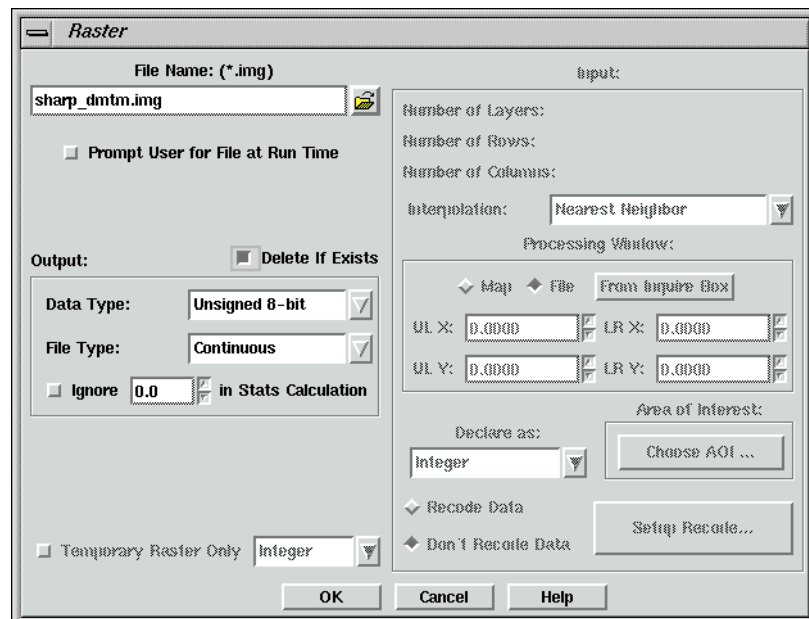

2. Click the Open icon, then navigate to a directory where you have write permission.



3. In the File Name dialog, enter **sharp\_dmtm.img** for the output image name.
4. Click **OK** in the File Name dialog.

The new file, **sharp\_dmtm.img**, is listed in the Raster dialog.

5. Click on the **Delete If Exists** checkbox.



# Spatial Modeler

This option allows you to run the model many times. You may have to run the model more than once to get it working.

6. Click on the **OK** button in the Raster dialog.

At this point, your model should look similar to the following:

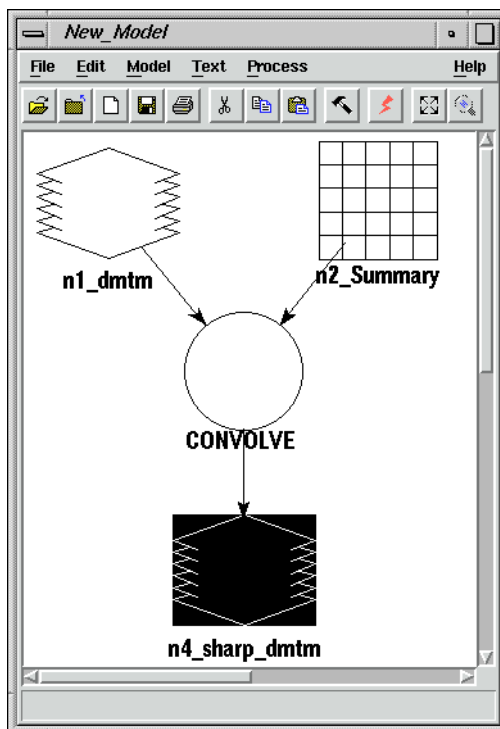

7. Select **Process | Run** or click on the Execute the Model icon in the tool bar.



A Job Status dialog opens, which tracks the progress of the model execution.

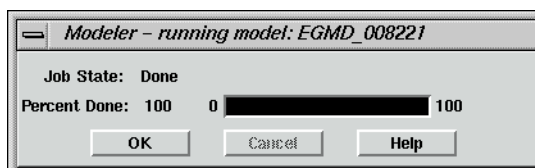

You receive an error similar to the following:



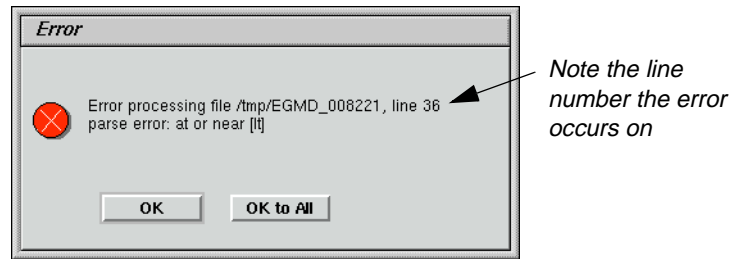

### Correct the Model

The next step is to figure out what this error means.

1. Click **OK** to dismiss the Error dialog.
2. Click **OK** to dismiss the Job Status dialog.



You can set the **Keep Job Status Box** in the **User Interface & Session** category of the **Preference Editor** so that the Job Status box is dismissed automatically after an operation is performed.

3. In the Model Maker viewer, select **Process/Generate Script**.

The name of the model displays here

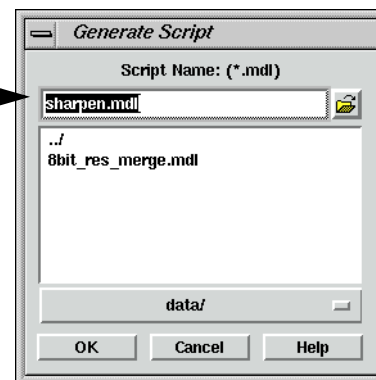

4. In the Generate Script dialog, click the Open icon, and navigate to a directory where you have write permission.
5. Enter the name **sharpen.mdl**, and click **OK**.

### Start the Model Librarian

1. In the Spatial Modeler dialog, click on the **Model Librarian** button.



# Spatial Modeler

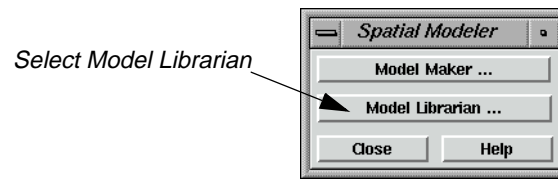

The Model Librarian dialog opens.

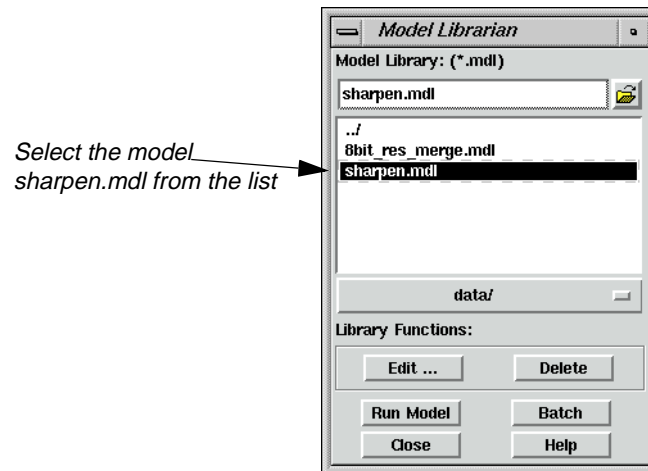

2. Navigate to the correct directory, then select **sharpen.mdl**.
3. Click on the **Edit** button in the Model Librarian dialog.

Select the **Current Line Number** option from this menu

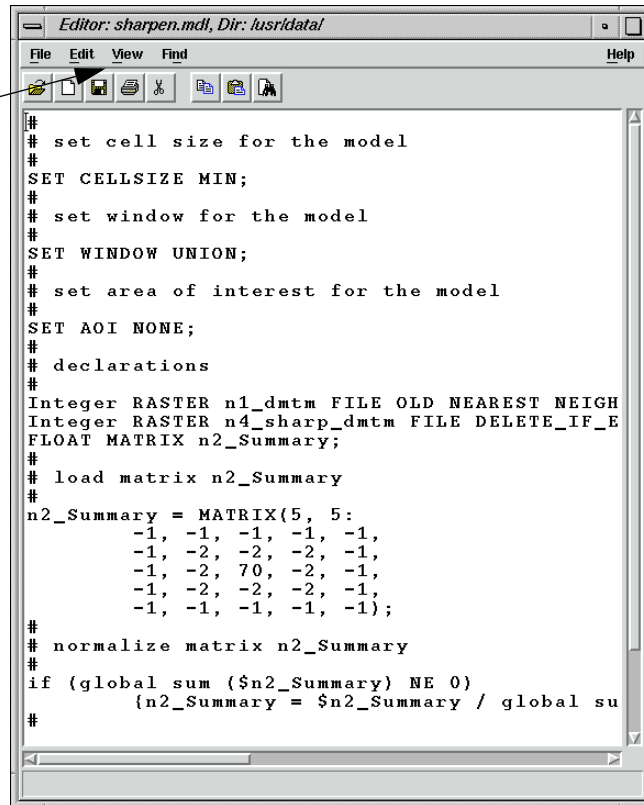

4. In the Editor window, select **View | Current Line Number**.

The Current Line Number dialog opens.

Enter the Line Number you want to view

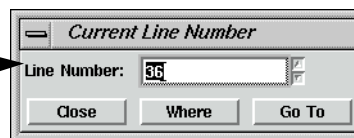

5. In the Current Line Number dialog, enter **36** for the **Line Number** (the line number referred to in the Error dialog).
6. Click the **Go To** button.

This highlights the line containing the error as depicted in the following picture:



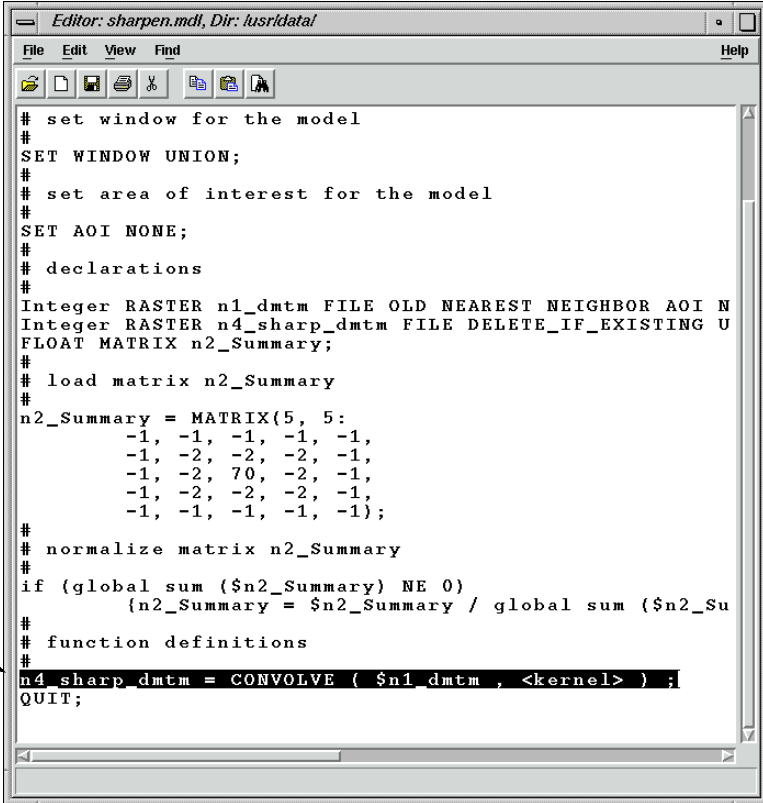

```
# set window for the model
#
SET WINDOW UNION;
#
# set area of interest for the model
#
SET AOI NONE;
#
# declarations
#
Integer RASTER n1_dmtm FILE OLD NEAREST NEIGHBOR AOI N
Integer RASTER n4_sharp_dmtm FILE DELETE_IF_EXISTING U
FLOAT MATRIX n2_Summary;
#
# load matrix n2_Summary
#
n2_Summary = MATRIX(5, 5:
    -1, -1, -1, -1, -1,
    -1, -2, -2, -2, -1,
    -1, -2, 70, -2, -1,
    -1, -2, -2, -2, -1,
    -1, -1, -1, -1, -1);
#
# normalize matrix n2_Summary
#
if (global sum {$n2_Summary} NE 0)
    {n2_Summary = $n2_Summary / global sum {$n2_Su
#
# function definitions
#
n4_sharp_dmtm = CONVOLVE ( $n1_dmtm , <kernel> );
QUIT;
```

If you examine the selected line, just to the right of the equal sign is a function, which also serves as a label to a Function object in the graphical model. Most syntax errors occur in Function definitions. In general, you generate a script so you can relate the line number given in the error message back to a particular Function object in the model.

### Correct the Function

1. In the Model Maker viewer, double-click the Function object, **CONVOLVE**.
2. Examine the function definition to determine the error.

In this case, you determine the function definition still has an argument prototype, **<kernel>**, that needs to be replaced with an actual argument.

3. In the lower portion of the Function Definition dialog, click in the middle of **<kernel>**.
4. Under **Available Inputs**, click on **\$n2\_Summary**.

Your Function Definition dialog now looks like the following:

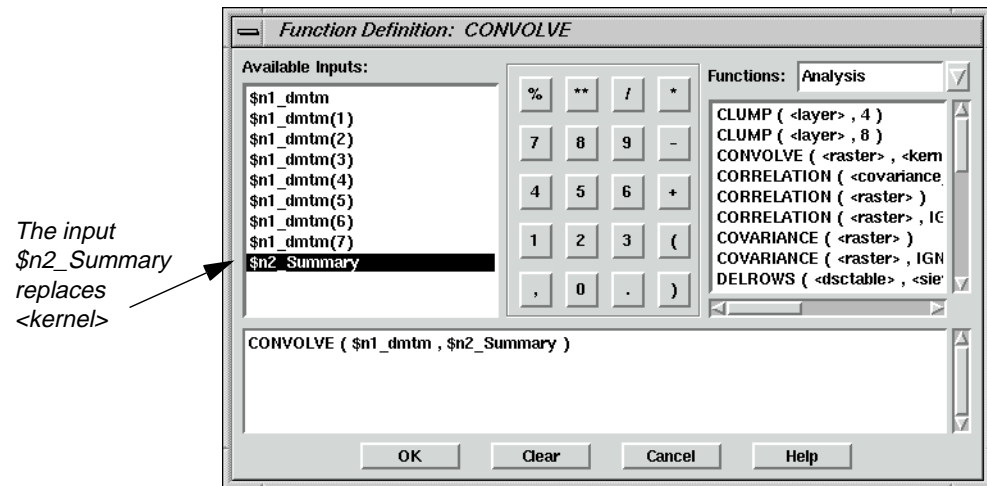

5. Click **OK** in the Function Definition dialog.

### Execute the Model

1. Select **Process | Run** or click on the Execute the Model icon in the tool bar.



The model should run to completion without error this time.

2. Click on the **OK** button to dismiss the Job Status dialog.

### Check the Results

1. Click the Viewer icon to open a new Viewer.



2. Click the Open icon, then navigate to the directory where you saved the file **sharp\_dmtm.img**.



3. Select the file **sharp\_dmtm.img**, then click **OK** in the Select Layer To Add dialog to open it in the Viewer.



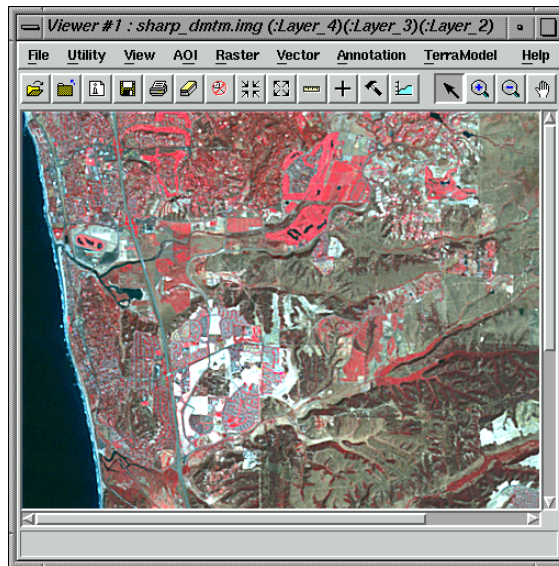

4. When you are finished viewing the image, click **File | Close** in the Viewer to close the image.

## Eliminate Object type Mismatch

There are five basic object types that can be either inputs to or outputs from a model. These are:

- Raster
- Vector (input only)
- Matrix
- Table
- Scalar

Depending on the arguments, each function produces a particular object type.

For example, the GLOBAL MAX function produces a Scalar if the argument is either a Matrix or a Table. However, it produces a Table if the argument is a Raster. In other words, for either a Matrix or a Table, the maximum value may be represented by a single number (i.e., Scalar). A Raster has a maximum value in each individual spectral band, so the result in this case is a Table of maximum values: one for each band. In order to be consistent, this is still true for a Raster with only one band. In this case a table is produced with a single entry.

In the following exercise, you build a model that rescales an image based on the maximum pixel value that actually occurs in an image. You do this using the GLOBAL MAX function. Initially, you incorrectly treat the output of the GLOBAL MAX function as a Scalar so you can see the type of error generated.

### Prepare

You must have ERDAS IMAGINE running.

1. Click the Modeler icon on the ERDAS IMAGINE icon panel.



The **Spatial Modeler** menu opens.

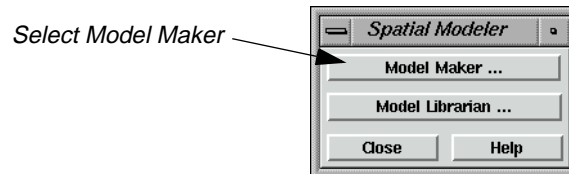

2. Click **Model Maker** on the **Spatial Modeler** menu.

A blank Spatial Modeler viewer opens along with the Model Maker tool palette.

### Create the Model

1. Click on the Raster icon in the Model Maker tool palette.



2. Click to position the Raster object in the upper left corner of the Model Maker viewer.
3. Click on the Function icon in the Model Maker tool palette.



4. Click to position the Function object below and to the right of the Raster object in the Model Maker viewer.
5. Click on the Scalar icon in the Model Maker tool palette.



6. Click to position the Scalar object below and to the right of the Function object in the Model Maker viewer.
7. Click on the Function icon in the Model Maker tool palette.
8. Click to position the Function object to the left of the Scalar object in the Model Maker viewer.
9. Click on the Raster icon in the Model Maker tool palette.
10. Click to position the Raster object below the Scalar object in the Model Maker viewer.



## Spatial Modeler

11. Click on the Connection icon in the Model Maker tool palette.



12. Click on the Lock icon in the Model Maker tool palette. It changes to the locked state.



13. Connect the first Raster to the first Function.
14. Also connect the first Raster to the second Function.
15. Connect the first Function to the Scalar.
16. Connect the Scalar to the second Function.
17. Connect the second Function to the final output Raster.

*NOTE: You may want to refer to the following diagram of the model to verify your connections. Connections may be broken or deleted by using the Connection tool in the reverse direction of the existing connection.*

18. Click on the Selector icon in the Model Maker tool palette.



19. Click on the Lock icon in the Model Maker tool palette to turn it off.



Your model should look like the following:

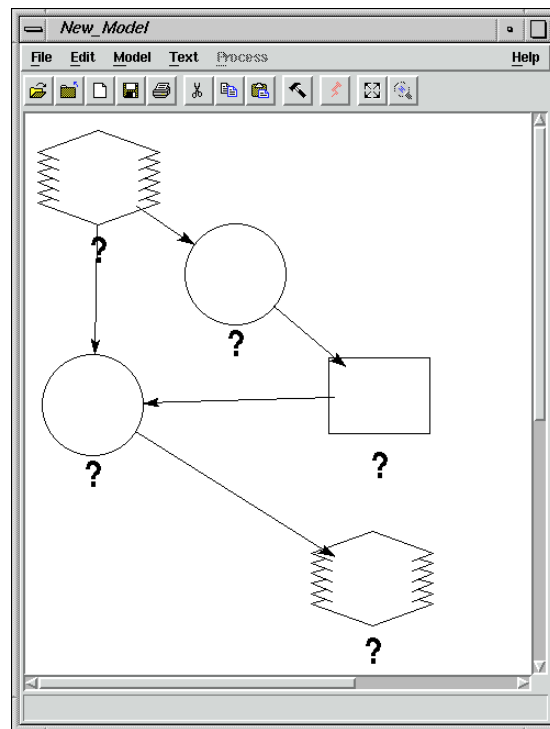

## Add Raster Properties

1. Double-click the first Raster object.

The Raster dialog opens.



# Spatial Modeler

Select the file  
*spots.img*

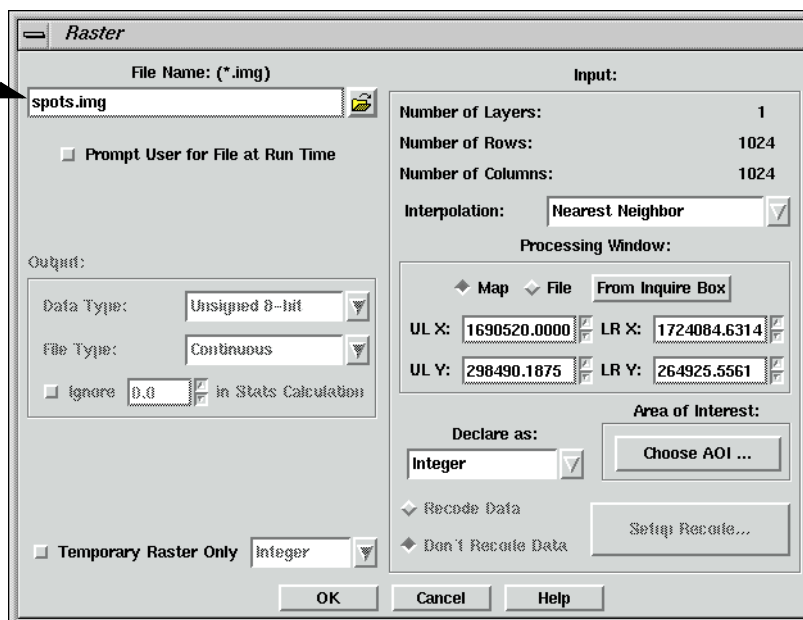

2. Click the Open icon on the Raster dialog, and navigate to the /examples directory.



3. In the Open File dialog, select **spots.img** and click **OK**.

## Add Function Properties

1. Double-click the first Function object.

The Function Definition dialog opens.

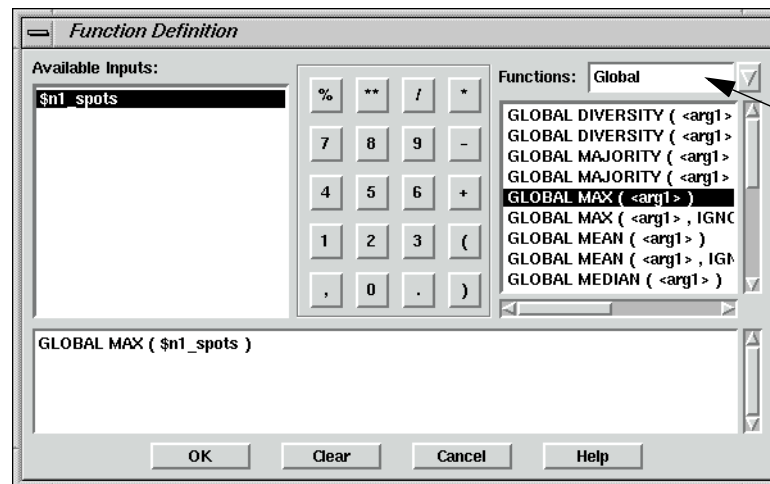

Select Global from the Functions list

2. In the **Functions** popup list, select **Global**.
3. In the list of **Global** functions, select **GLOBAL MAX ( <arg1> )**.
4. In the lower portion of the Function Definition dialog, click in the middle of **<arg1>**.
5. Under **Available Inputs**, click on **\$n1\_spots**.
6. Click **OK** in the Function Definition dialog.

### Add Scalar Properties

1. Double-click the Scalar object.

The Scalar dialog opens.

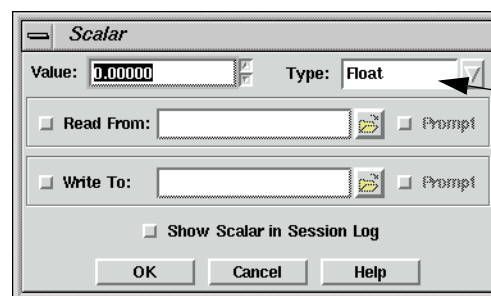

Confirm that the Type is set to Float

2. Verify that the **Type** is set to **Float**, and click **OK**.

You select **Float** to insure the model uses floating point arithmetic instead of integer arithmetic. You do this because you are calculating a ratio between 255 and the GLOBAL MAX. In other words, you want to be able to multiply the pixel values by numbers such as 1.3, 2.1, or 3.4 and not just 1, 2, or 3.



# Spatial Modeler

## Add Function Properties

1. Double-click the second Function object.

The Function dialog opens.

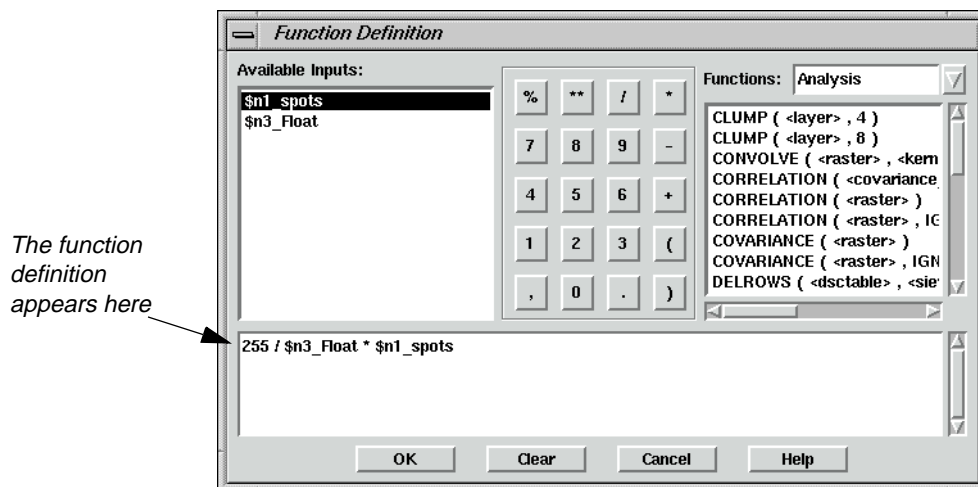

2. Using the calculator portion of the Function Definition dialog enter **255 /**.
3. Under **Available Inputs** click on **\$n3\_Float**.
4. In the calculator portion of the Function Definition dialog click on **\***.
5. Under **Available Inputs** click on **\$n1\_spots**.
6. Click **OK** in the Function Definition dialog.

## Add Raster Properties

1. Double-click the output Raster object.

The Raster dialog opens.

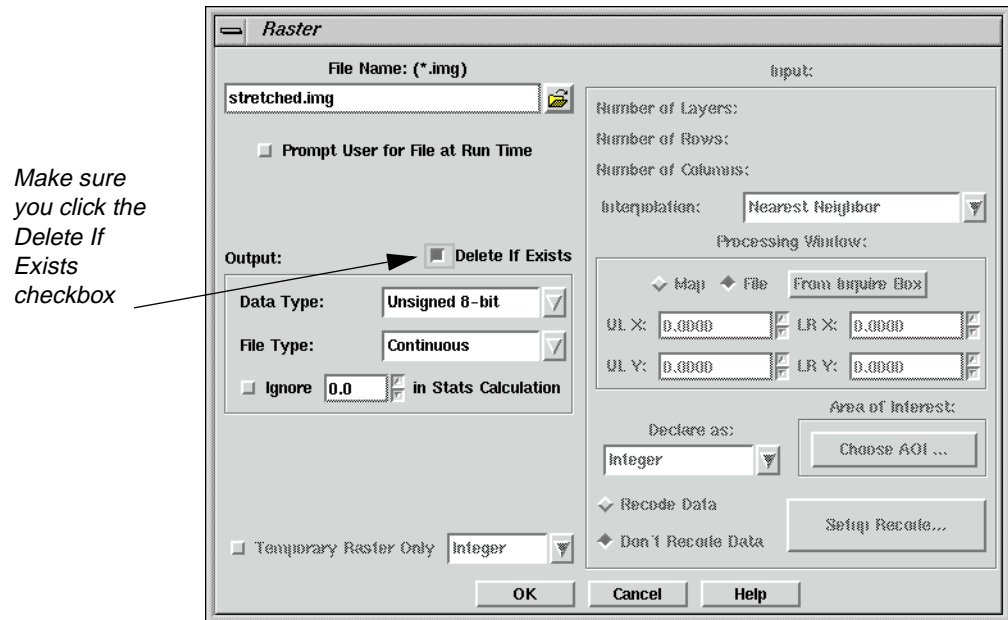

2. Click the Open icon in the Raster dialog, then navigate to a directory where you have write permission.



3. Enter **stretched.img** for the output image name, then click **OK** in the File Name dialog.

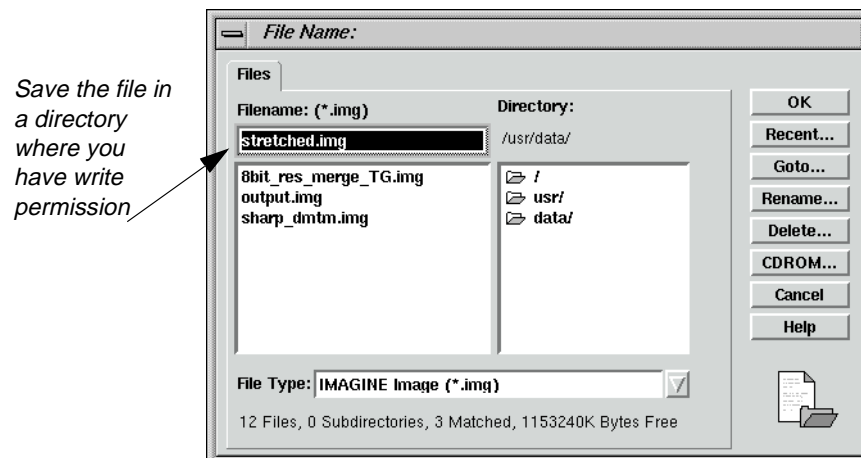

4. In the Raster dialog, click the **Delete If Exists** checkbox.  
You may have to run the model more than once to get it working.
5. Click on the **OK** button.



# Spatial Modeler

At this point, your model should look similar to the following:

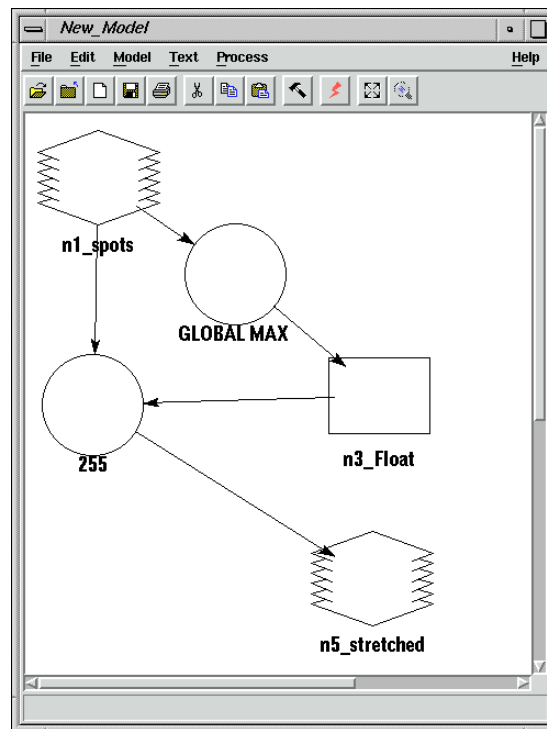

## Execute the Model

1. Select **Process | Run** or click on the Execute the Model icon in the tool bar.



A Job Status dialog opens.

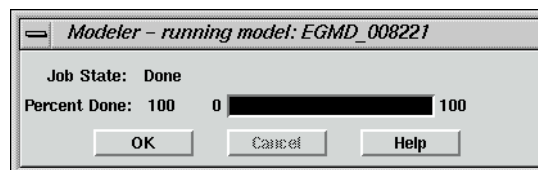

You receive an error like the following:

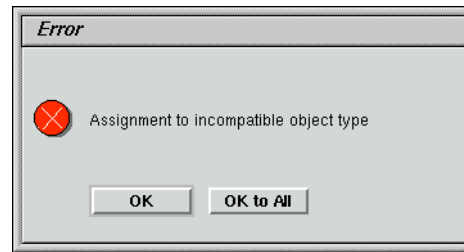

The next step is to figure out what this error means.

2. Click **OK** to dismiss the Error dialog.
3. Click **OK** to dismiss the Job Status dialog.

### Check the On-Line Help

When a model is executed, an Assignment statement is generated for each Function object in the model. The error is telling you that one of the Function objects in the model is generating a different object type than what you have it connected to.

You know that in one of our Function objects we using the GLOBAL MAX function, and in the other you are just doing arithmetic. At this point, you can use the online documentation to help out.

1. Click **Help | Help for Model Maker**.
2. Click on the hyperlink to the **Spatial Modeler Language Reference Manual** in the third paragraph. The on-line manual is in Adobe® portable document format (SML.pdf). It will open in a new browser window.
3. In the Navigation Pane, click on the + beside **Section II SML Function Syntax** to view all topics included in that section.
4. Click on the **Arithmetic** topic to open that page in the Acrobat viewer.



# Spatial Modeler

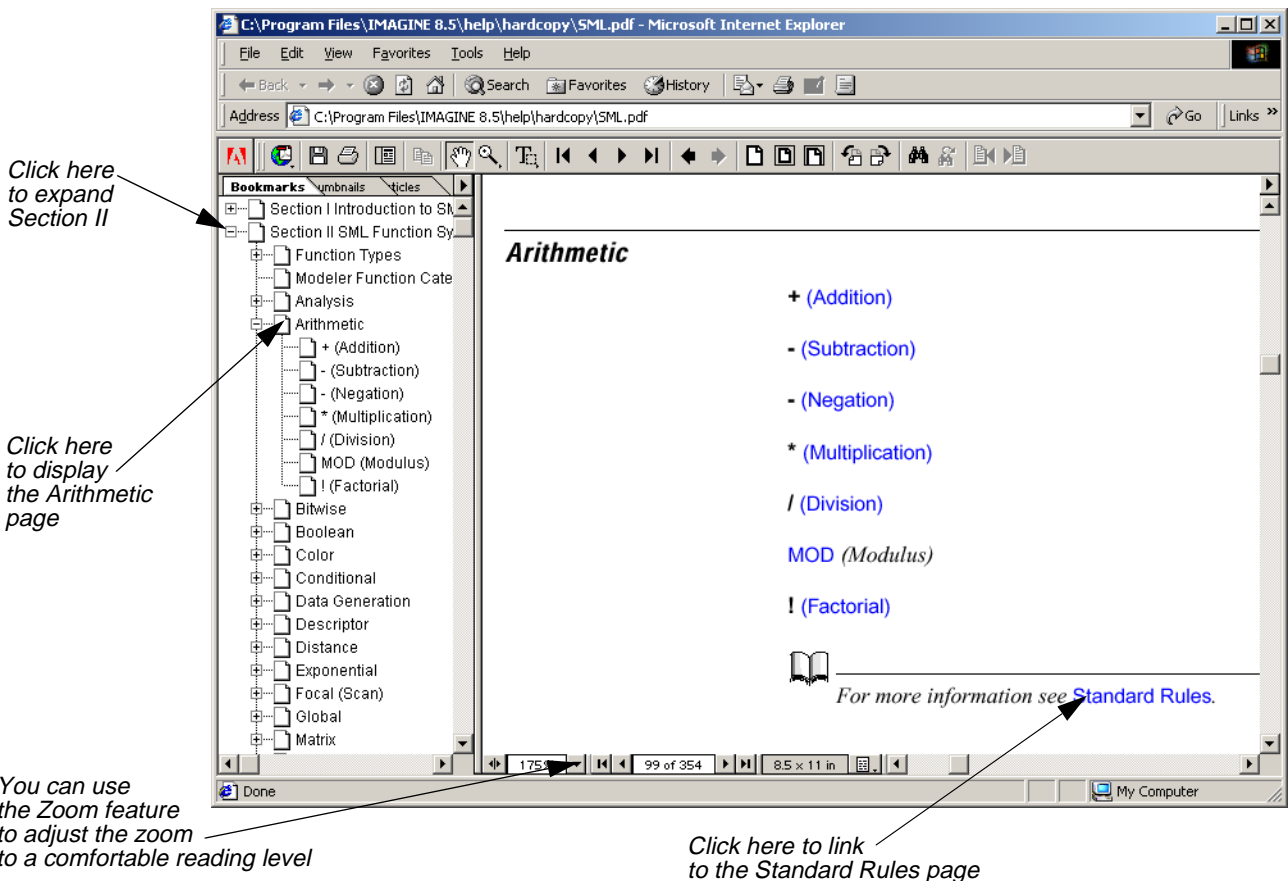

5. After reading the topic, click on the hyperlink to open the **Standard Rules** page. The **Standard Rules for Combining Different Types** topic displays.

6. Scroll down to the **Object Types** section.

While this section contains some very useful information, it gives no indication that anything is wrong with the Function in which you are doing simple arithmetic.

7. In the Navigation Pane, click on the + beside **Global** to view all the pages under this topic..

8. Click on **GLOBAL MAX (Global Maximum)** to display this topic.

9. Scroll down to the **Object Types** section.

Note the on-line documentation states, "If <arg1> is a RASTER, the result is a TABLE with the same number of rows as <arg1> has layers". In your model, you incorrectly connected the output of GLOBAL MAX of a Raster to a Scalar instead of a Table.

10. Select **File | Exit** from the On-Line Help dialog.





### Correct the Model

1. In the Model Maker viewer, click on the Scalar object.
2. Select **Edit | Clear**, or press the Delete key on your keyboard.
3. Click on the Table icon in the Model Maker tool palette.



4. Click to position the Table object in the location where the Scalar object was in the Model Maker viewer.
5. Using the Connection tool, connect the first Function to the Table, and the Table to the second Function.

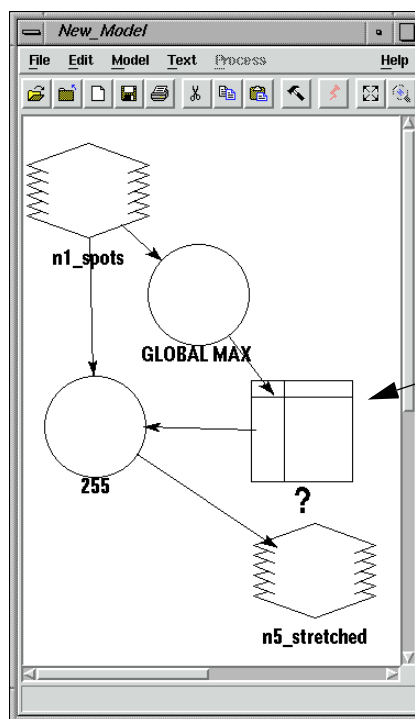

*The Table replaces the Scalar you originally placed in the model*

### Add Table Properties

1. Using the Selector tool, double-click the Table object in the Model Maker viewer.  
The Table Definition dialog opens.



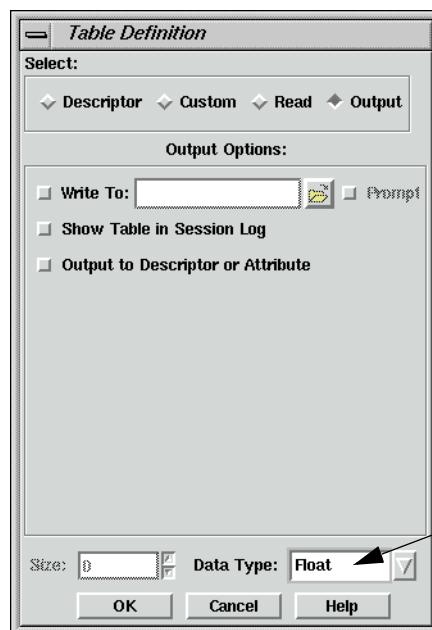

2. Click the **Data Type** popup list, and select **Float**.
3. Click on the **OK** button.

## Correct Function Properties

1. Double-click the second Function object.

Notice Model Maker replaced the name of the deleted Scalar object with a **<scalar>** place holder. It did this to remind you what was there before. In this case, you replace **<scalar>** with a Table.

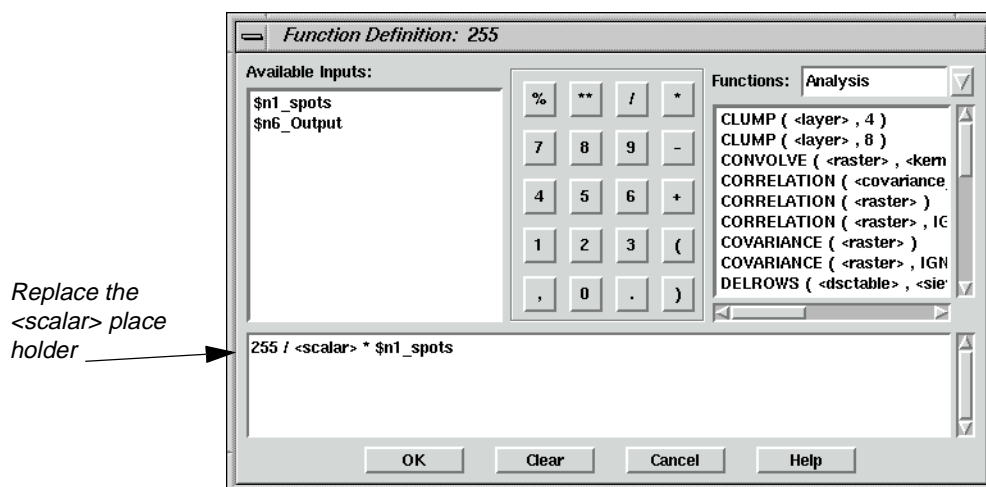

2. In the lower portion of the Function Definition dialog, click in the middle of **<scalar>**.

- Under **Available Inputs**, click on **\$n6\_Output**.

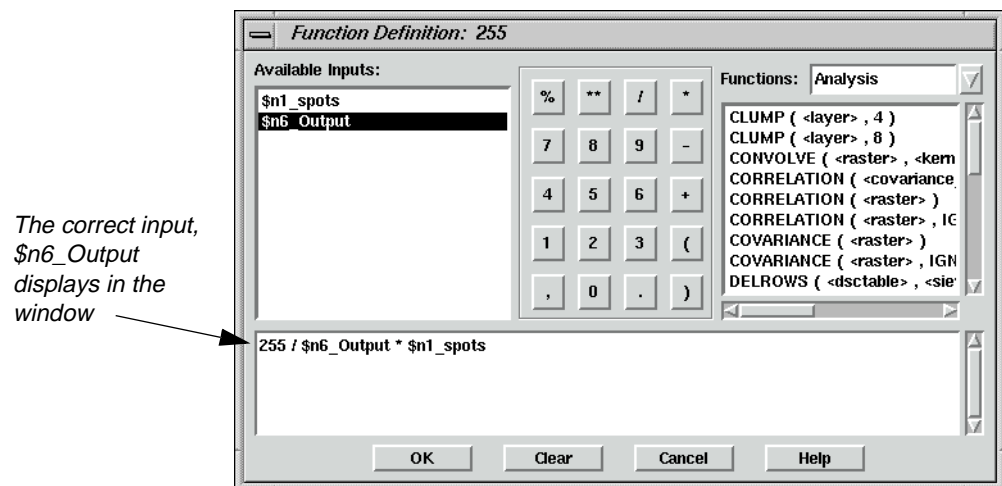

- Click on the **OK** button in Function Definition dialog.

### Execute the Model

- Select **Process | Run** or click on the Execute the Model icon in the tool bar.



The model should run to completion without error this time.

- Click on the **OK** button to dismiss the Job Status dialog.

The other advantage our model has, by properly treating the output of the GLOBAL MAX function as a Table, is that it works whether the input image has only a single band or hundreds of bands. Remember that, with multispectral data, the Table generated by the GLOBAL MAX function has an entry for each band representing the maximum value in each band, respectively. When we multiply a Raster by a Table, each band in the Raster is multiplied by the corresponding entry in the Table. This allows our model to work on all bands at once without having to loop through each band.

### View the Results

- Click the Viewer icon to open a new Viewer.



## Spatial Modeler

2. Click the Open icon, then navigate to the directory where you saved the file **sharp\_dmtm.img**.



3. Select the file **stretched.img**, then click **OK** in the Select Layer To Add dialog to open it in the Viewer.

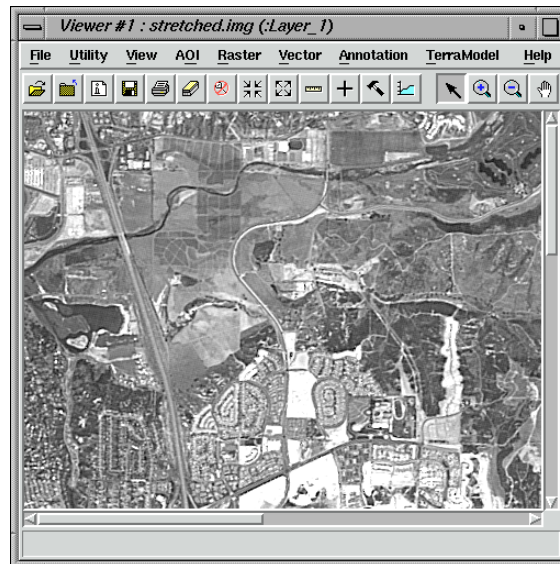

When you are finished, click **File | Close** in the Viewer to close the image.



### Eliminate Division by Zero

*Now that you are familiar with the tools and interface of the Spatial Modeler, the following two examples, "Eliminate Division by Zero" and "Use AOIs in Processing" do not have detailed instructions, or as many screen captures to guide you through the process.*

Calculating band ratios with multispectral imagery is a very common image processing technique. Calculating a band ratio can be as simple as dividing one spectral band by another. Any time division is done, care should be taken to avoid division by zero, which is undefined. In the following model, you can see what errors division by zero can cause and how to correct these errors.

#### Prepare

You must have Model Maker running.

#### Create the Model

1. Click on the Raster icon in the Model Maker tool palette.



2. Click near the upper left corner of the Model Maker viewer.
3. Click on the Function icon in the Model Maker tool palette.
4. Click below and to the right of the Raster object in the Model Maker viewer.
5. Click on the Raster icon in the Model Maker tool palette.
6. Click below and to the right of the Function object in the Model Maker viewer.
7. Click on the Connection icon in the Model Maker tool palette.
8. Click on the Lock icon in the Model Maker tool palette.
9. Connect the first Raster object to the Function object as an input.
10. Connect the Function object to the final Raster object as an output.
11. Click on the Selector icon in the Model Maker tool palette.
12. Click on the Lock icon in the Model Maker tool palette to turn it off.

### Add Raster Properties

1. Double-click on the first Raster object.
2. Select **ortho.img** from the examples directory and click **OK**.

### Add Function Properties

1. Double-click on the Function object.
2. Under **Available Inputs**, click on **\$n1\_ortho(1)**.
3. In the Calculator portion of the Function Definition dialog, click on the / key.
4. Under **Available Inputs**, click on **\$n1\_ortho(2)**.
5. Click on the **OK** button.

### Add Raster Properties

1. Double-click on the output Raster object.
2. Navigate to a directory where you have write permission, and enter **veg\_index.img** for the output image name.
3. Click on the **Delete If Exists** (you are going to run the model more than once to get it working properly).
4. Click on the **OK** button.

At this point, your model should look similar to the following:



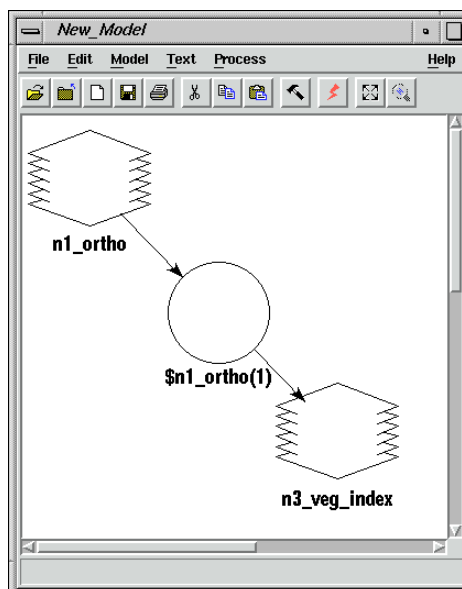

## Execute the Model

1. Select **Process | Run** or click on the Execute the Model icon in the tool bar.

After your model appears to have run to completion you receive the following error:

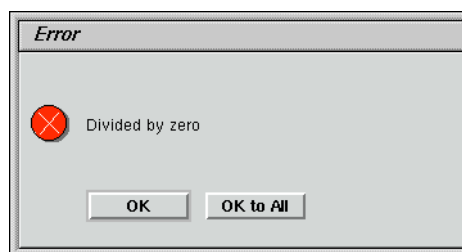

Next, you attempt to avoid dividing by zero by setting the output pixel value to zero any place there would be a division by zero.

2. Click **OK** to dismiss the Error dialog.
3. Click **OK** to dismiss the Modeler status dialog.

## Change Function Properties

1. In the Model Maker viewer, double-click on the Function object.
2. Click on the **Clear** button to start our function definition from scratch.
3. In the **Functions** popup list, select **Conditional**.

4. In the list of functions, select **EITHER <arg1> IF ( <test> ) OR <arg2> OTHERWISE**, this should be the second item on the list.
5. In the lower portion of the Function Definition dialog, click in the middle of **<arg1>**.
6. In the Calculator portion of the Function Definition dialog, click on the **0** key.
7. In the lower portion of the Function Definition dialog, click in the middle of **<test>**.
8. Under **Available Inputs**, click on **\$n1\_ortho(2)**.
9. In the **Functions** popup list select **Relational**.
10. In the list of functions select **==**, this should be the first item on the list.
11. In the Calculator portion of the Function Definition dialog click on the **0** key.
12. In the lower portion of the Function Definition dialog, click in the middle of **<arg2>**.
13. Under **Available Inputs**, click on **\$n1\_ortho(1)**.
14. In the Calculator portion of the Function Definition dialog, click on the **/** key.
15. Under **Available Inputs**, click on **\$n1\_ortho(2)**.

Your Function Definition dialog should now contain the following:

```
EITHER 0 IF ( $n1_ortho(2) == 0 ) OR $n1_ortho(1) / $n1_ortho(2) OTHERWISE
```

16. Click on the **OK** button.

### Execute the Model

1. Select **Process | Run**, or click on the Execute the Model icon in the tool bar.

After all the careful checking for division by zero you get the same error. The reason you still get the same error is that Modeler evaluates the entire statement at once. As it turns out, the error is generated when you do an Integer division by zero. So in order to avoid the integer division and the resulting error, you can use floating point arithmetic to set the output pixel value. You can force the use of floating point arithmetic by simply declaring our input Raster to be of type Float.

2. Click **OK** to dismiss the Error dialog.
3. Click **OK** to dismiss the Modeler status dialog.

### Change Raster Properties

1. In the Model Maker viewer, double-click on the input Raster object.
2. In the lower central portion of the Raster dialog, in the **Declare As** popup list select **Float**.

## Spatial Modeler

3. Click on the **OK** button.
4. Select **Process | Run** or click on the Execute the Model icon in the tool bar.

The model now runs successfully to completion without any errors. However, if you view the resulting image, **veg\_index.img**, you notice that it is relatively dark and does not contain much detail.



This happens because, even though you are calculating a floating-point ratio, you are still outputting an integer result. So, all resulting output pixel values are being truncated to integers. This includes all pixels where the pixel value in band two is larger than the pixel value in band one—these are all set to 0 instead of retaining values such as 0.25, 0.833, or 0.498. In order to maintain the information being calculated, all you have to do is change the type of output file being generated.

### Change Raster Properties

1. In the Model Maker viewer, double-click on the output Raster object.
2. In the Raster dialog in the **Data Type** popup list select **Float Single**.
3. Click on the **OK** button.
4. Select **Process | Run** or click on the Execute the Model icon in the tool bar.

If you view the resulting output image now, you see the full detail from the computations, which are available for further analysis.





### Use AOIs in Processing

Area Of Interest (AOI) processing can be used to restrict the area processed of individual images or of the model as a whole. AOIs can be used as masks to cookie cut the desired portions of images. When and how the mask is applied may not be of much interest in a model utilizing point operations. However, in models doing neighborhood operations, when the AOI is applied yields differing results.

For example, if you cookie cut the input image with an AOI before doing an edge detection filter, the model produces artificial edges around the AOI. In this case, you want to do the edge detection on the original input image and cookie cut the results with the AOI. Besides using AOIs as processing masks, Vector layer inputs may also be used. In the following example, you generate and use an AOI to smooth out the appearance of the water in Mobile Bay.

#### Prepare

You must have Model Maker running.

1. Click on the Raster icon in the Model Maker tool palette.
2. Click near the upper left corner of the Model Maker viewer.

#### Create AOI

1. In a Viewer, open **mobbay.img** from the /examples directory.
2. In the Viewer, click on the Show Tool Palette for Top Layer icon.
3. Select the Region Grow AOI tool from the palette.
4. Click a dark portion of the water near the southeast corner of the image.
5. From the **AOI** menu select **Seed Properties**.
6. Click the **Area** checkbox to turn it off.



7. Enter **20.0** for the **Spectral Euclidean Distance**.
8. Click on the **Redo** button.

## Add Raster Properties

1. Double-click on the first Raster object.
2. Select **mobbay.img** from the /examples directory.
3. Click on the **Choose AOI** button on the right side of the Raster dialog.
4. Select **Viewer** as the **AOI Source** and click **OK**.
5. Click **OK** in the Raster dialog.

## Add Raster Properties

1. Click on the Raster icon in the Model Maker tool palette.
2. Click to the right of the existing Raster in the Model Maker viewer.
3. Double-click this newly placed Raster object.
4. Select **mobbay.img** from the /examples directory.
5. This time do not select an AOI, but rather just click **OK** in the Raster dialog.

## Add Matrix Properties

1. Click on the Matrix icon in the Model Maker tool palette.
2. Click just to the right of the two Raster objects in the Model Maker viewer.
3. Double-click this newly placed Matrix object.
4. In the **Size** popup list select **5 × 5**.
5. Click **OK**.

## Add Function Properties

1. Click on the Function icon in the Model Maker tool palette.
2. Click below **n3\_Low\_Pass** in the Model Maker viewer.
3. Connect **n2\_mobbay** and **n3\_Low\_Pass** to the newly placed Function object.
4. Double-click on the Function object.
5. From the analysis **Functions** select **CONVOLVE ( <raster> , <kernel> )**, this should be the third item on the list.
6. In the lower portion of the Function Definition dialog, click in the middle of **<raster>**.
7. Under **Available Inputs**, click on **\$n2\_mobbay**.

8. In the lower portion of the Function Definition dialog, click in the middle of **<kernel>**.
9. Under **Available Inputs**, click on **\$n3\_Low\_Pass**.
10. Click **OK**.

### Add Raster Properties

1. Click on the Raster icon in the Model Maker tool palette.
2. Click below the Function object in the Model Maker viewer.
3. Connect the Function object to the new Raster object.
4. Double-click the new Raster object.
5. Click **Temporary Raster Only**.
6. Click **OK**.

### Add Function Properties

1. Click on the Function icon in the Model Maker tool palette.
2. Click to the left of **n5\_memory** in the Model Maker viewer.
3. Connect **n1\_mobbay**, **n2\_mobbay**, and **n5\_memory** to the Function object.
4. Double-click on the Function object.
5. In the **Functions** popup list select **Conditional**.
6. In the list of functions select **EITHER <arg1> IF ( <test> ) OR <arg2> OTHERWISE**, this should be the second item on the list.
7. In the lower portion of the Function Definition dialog, click in the middle of **<arg1>**.
8. Under **Available Inputs**, click on **\$n5\_memory**.
9. In the lower portion of the Function Definition dialog, click in the middle of **<test>**.
10. Under **Available Inputs**, click on **\$n1\_mobbay**.
11. In the lower portion of the Function Definition dialog, click in the middle of **<arg2>**.
12. Under **Available Inputs**, click on **\$n2\_mobbay**.



# Spatial Modeler

Your Function Definition dialog should now contain the following:

```
EITHER $n5_memory IF ( $n1_mobbay ) OR $n2_mobbay OTHERWISE
```

**\$n5\_memory** is the filtered image, **\$n1\_mobbay** has the AOI mask, and **\$n2\_mobbay** is the original image.

13. Click **OK**.

## Add Raster Properties

1. Click on the Raster icon in the Model Maker tool palette.
2. Click below the new Function object in the Model Maker viewer.
3. Connect the Function object to the Raster object.
4. Double-click on the output Raster object.
5. Navigate to a directory where you have write permission and enter **smooth\_water.img** for the output image name.
6. Click on the **Delete If Exists**, in case you need to run the model more than once to get it working properly.
7. Click on the **OK** button.

Your model should look like the following:



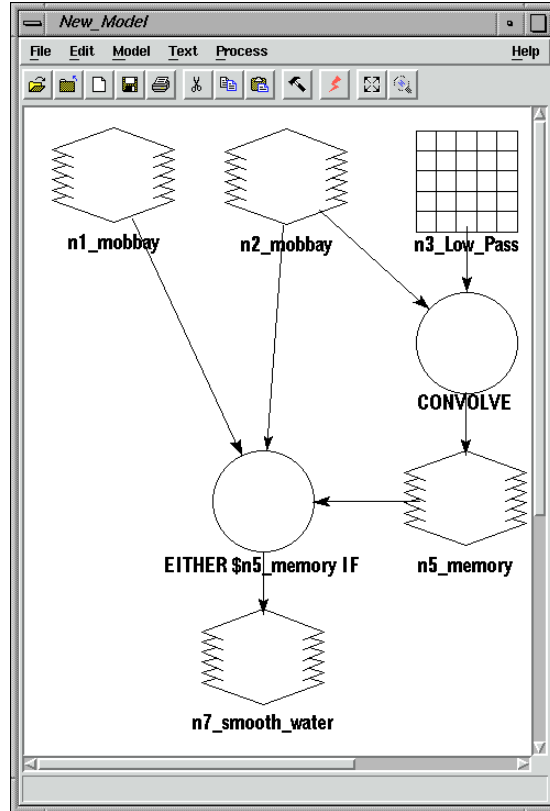

## Execute the Model

1. Select **Process | Run** or click on the Execute the Model icon in the tool bar.
2. Use the Viewer and the Swipe tool to compare the original **mobbay.img** and the new **smooth\_water.img**.



# Spatial Modeler

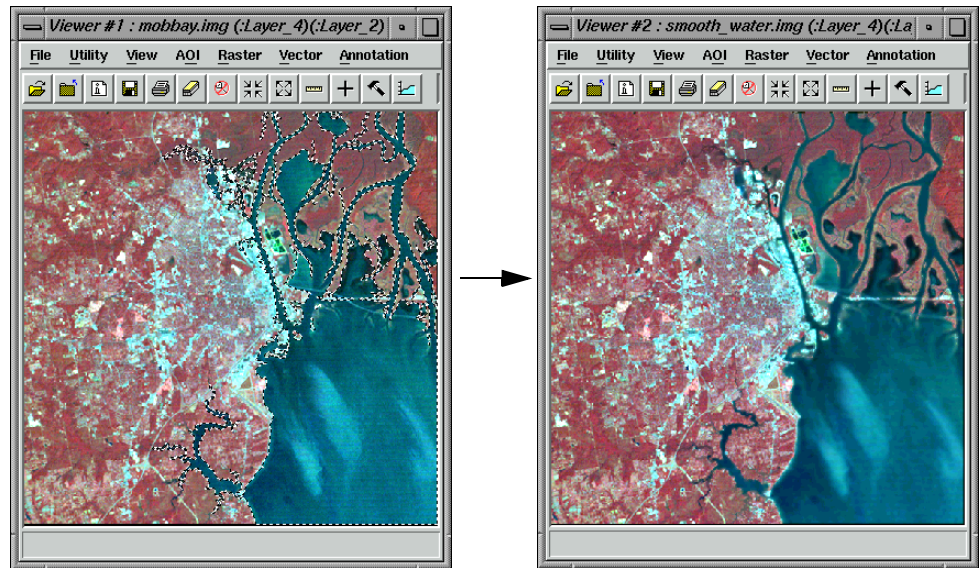

Compare the image on the left, above, with the image on the right. The image on the right has been visibly smoothed in the areas of water. You can see this more clearly if you use the Swipe utility in the Viewer.

# CHAPTER 17

## Advanced Classification

---

### Introduction

Classification is the process of sorting pixels into a finite number of individual classes, or categories of data based on their data file values. If a pixel satisfies a certain set of criteria, then the pixel is assigned to the class that corresponds to that criteria.

There are two ways to classify pixels into different categories:

- supervised
- unsupervised

### Supervised vs. Unsupervised Classification

Supervised classification is more closely controlled by you than unsupervised classification. In this process, you select pixels that represent patterns you recognize or that you can identify with help from other sources. Knowledge of the data, the classes desired, and the algorithm to be used is required before you begin selecting training samples.

By identifying patterns in the imagery, you can train the computer system to identify pixels with similar characteristics. By setting priorities to these classes, you supervise the classification of pixels as they are assigned to a class value. If the classification is accurate, then each resulting class corresponds to a pattern that you originally identified.

Unsupervised classification is more computer-automated. It allows you to specify parameters that the computer uses as guidelines to uncover statistical patterns in the data.

In this tour guide, you perform both a supervised and an unsupervised classification of the same image file.



---

*All of the data used in this tour guide are in the <IMAGINE\_HOME>/examples directory. You should copy the **germtm.img** file to a different directory so that you can have write permission to this file.*



---

*Approximate completion time for this tour guide is 1 hour, 15 minutes.*

---

### Perform Supervised Classification

This section shows how the Supervised Classification tools allow you to control the classification process.

You perform the following operations in this section:

- define signatures
- evaluate signatures
- process a supervised classification

# Advanced Classification

## Prepare

ERDAS IMAGINE must be running and a Viewer must be open.

## Define Signatures using Signature Editor

The ERDAS IMAGINE Signature Editor allows you to create, manage, evaluate and edit signatures (.sig extension). The following types of signatures can be defined:

- parametric (statistical)
- nonparametric (feature space)

In this section, you define the signatures using the following operations:

- collect signatures from the image to be classified using the area of interest (AOI) tools
- collect signatures from the Feature Space image using the AOI tools and Feature Space tools

## Display File

1. Select **File | Open | Raster Layer** from the Viewer menu bar or click the Open icon on the Viewer tool bar to display the image file to be classified.



The Select Layer To Add dialog opens.

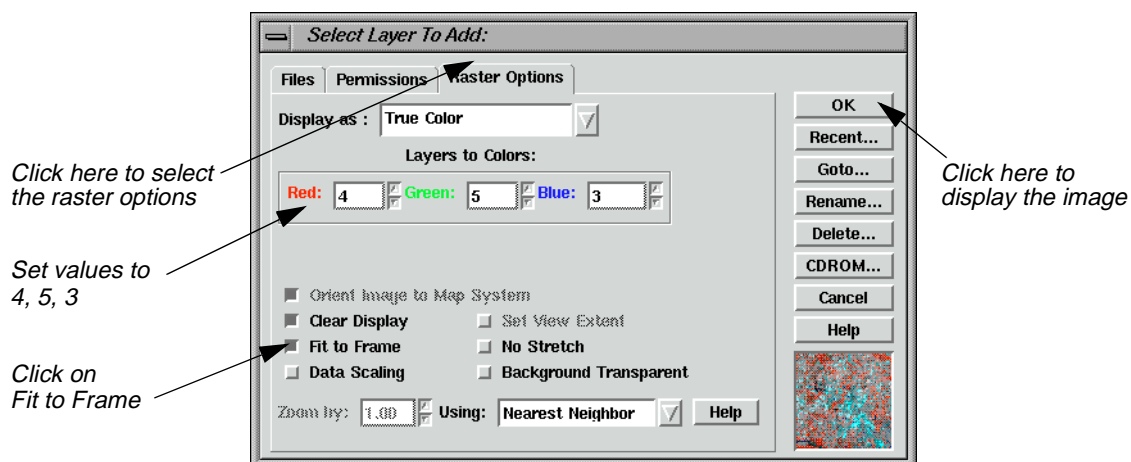

2. In the Select Layer To Add dialog under **Filename**, select **germtm.img**. This is the image file that is going to be classified.
3. Click on the **Raster Options** tab at the top of the dialog, and then set the **Layers to Colors** to **4, 5, and 3** (red, green, and blue, respectively).
4. Click the **Fit to Frame** option to enable it.



## Perform Supervised Classification

5. Click **OK** in the Select Layer To Add dialog.

The file **germtm.img** displays in the Viewer.

### Open Signature Editor

1. Click on the Classifier icon on the ERDAS IMAGINE icon panel.



The **Classification** menu displays.

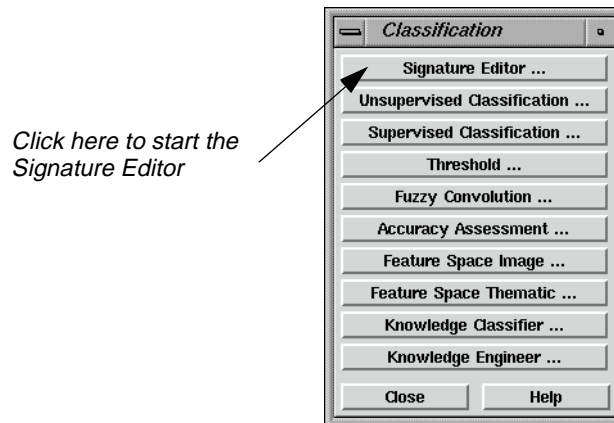

2. Select **Signature Editor** from the **Classification** menu to start the Signature Editor.

The Signature Editor opens.

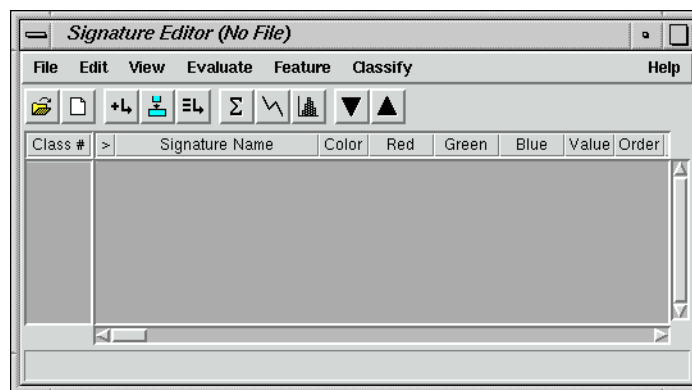

3. In the **Classification** menu, click **Close** to remove this menu from the screen.
4. In the Signature Editor, select **View | Columns**.

## Advanced Classification

The View Signature Columns dialog opens.

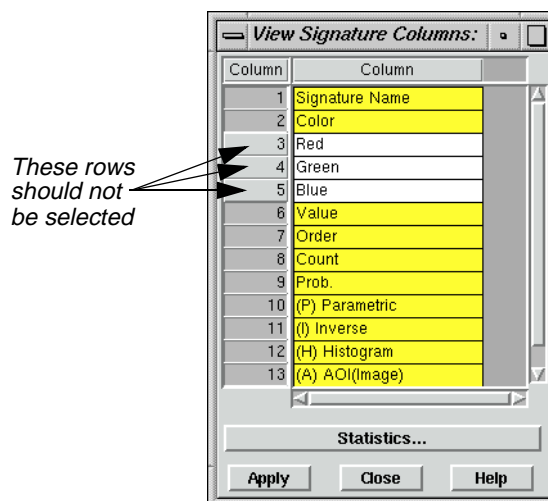

5. In the View Signature Columns dialog, select all of the rows by Shift-holding in the first row of the first **Column** and dragging down.

6. Shift-click **Red**, **Green**, and **Blue** in **Column** boxes **3**, **4**, and **5** to deselect these rows.

These are the CellArray columns in the Signature Editor that you remove to make it easier to use. These columns can be returned at any time.

7. In the View Signature Columns dialog, click **Apply**.

The **Red**, **Green**, and **Blue** columns are deleted from the Signature Editor.

8. Click **Close** in the View Signature Columns dialog.

### Use AOI Tools to Collect Signatures

The AOI tools allow you to select the areas in an image to be used as a signature. These signatures are parametric because they have statistical information.

1. Select **AOI | Tools** from the Viewer menu bar.

The AOI tool palette displays.



## Advanced Classification

5. In the Signature Editor, click on the Create New Signature(s) from AOI icon or select **Edit | Add** from the menu bar to add this AOI as a signature.



6. In the Signature Editor, click inside the **Signature Name** column for the signature you just added. Change the name to **Agricultural Field\_1**, then press Return on the keyboard.
7. In the Signature Editor, hold in the **Color** column next to **Agricultural Field\_1** and select **Green**.

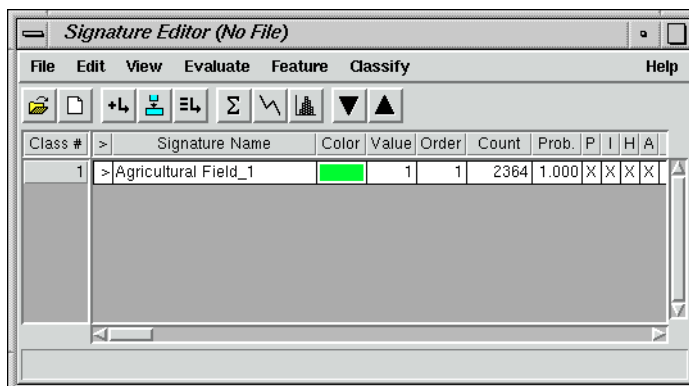

8. Zoom in on one of the light blue/cyan areas in the **germtm.img** file in the Viewer.
9. Draw a polygon as you did in steps (2. through step 4).  
  
These areas are also agricultural fields.
10. After the AOI is created, a bounding box surrounds the polygon, indicating that it is currently selected. In the Signature Editor, click on the Create New Signature(s) from AOI icon or select **Edit | Add** to add this AOI as a signature.



11. In the Signature Editor, click inside the **Signature Name** column for the signature you just added. Change the name to **Agricultural Field\_2**, then press Return on the keyboard.
12. In the Signature Editor, hold in the **Color** column next to **Agricultural Field\_2** and select **Cyan**.

### Select Neighborhood Options

This option determines which pixels are considered contiguous (i.e., similar values) to the seed pixel or any accepted pixels.

1. Select **AOI | Seed Properties** from the Viewer menu bar.

## Perform Supervised Classification

The Region Growing Properties dialog opens.

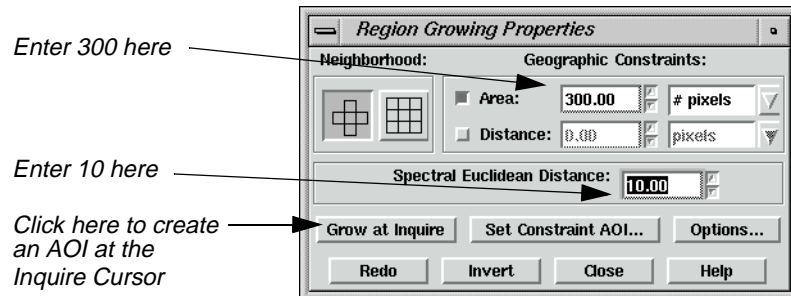

2. Click on the Neighborhood icon in the Region Growing Properties dialog.



This option specifies that four pixels are to be searched. Only those pixels above, below, to the left, and to the right of the seed or any accepted pixels are considered contiguous.

3. Under **Geographic Constraints**, the **Area** checkbox should be turned on to constrain the region area in pixels. Enter **300** into the **Area** number field and press Return on your keyboard.

This is the maximum number of pixels that are in the AOI.

4. Enter **10.00** in the **Spectral Euclidean Distance** number field.

The pixels that are accepted in the AOI are within this spectral distance from the mean of the seed pixel.

5. Next, click on **Options** in the Region Growing Properties dialog.

The Region Grow Options dialog opens.

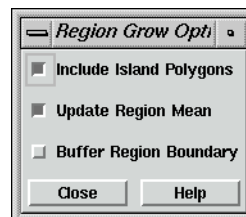

6. In the Region Grow Options dialog, make sure that the **Include Island Polygons** checkbox is turned on in order to include polygons in the growth region.
7. Click **Close** in the Region Grow Options dialog.

### Create an AOI

1. In the AOI tool palette, click on the Region Grow icon.



## Advanced Classification



2. Click inside a bright red area in the **germtm.img** file in the Viewer.

This is a forest area. A polygon opens and a bounding box surrounds the polygon, indicating that it is selected.

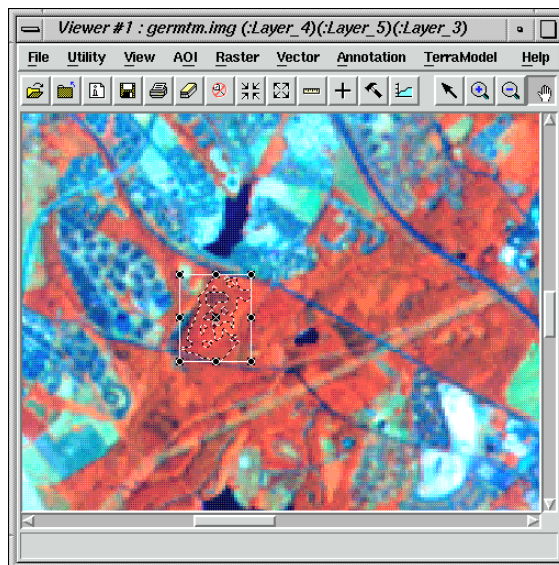

3. In the Region Growing Properties dialog, enter new numbers in the **Area** and **Spectral Euclidean Distance** number fields (e.g., **500** for **Area** and **15** for **Spectral Euclidean Distance**) to see how this modifies the AOI polygon.
4. In the Region Growing Properties dialog, click **Redo** to modify the AOI polygon with the new parameters.

### Add a Signature

1. After the AOI is created, click on the Create New Signature(s) from AOI icon in the Signature Editor to add this AOI as a signature.



2. In the Signature Editor, click inside the **Signature Name** column for the signature you just added. Change the name to **Forest\_1**, then press Return on the keyboard.
3. In the Signature Editor, hold in the **Color** column next to **Forest\_1** and select **Yellow**.
4. In the Region Growing Properties dialog, enter **300** in the **Area** number field.

### Add Another Signature

1. In the Viewer, select **Utility | Inquire Cursor**.

The Inquire Cursor dialog opens and the inquire cursor (a white crosshair) is placed in the Viewer. The inquire cursor allows you to move to a specific pixel in the image and use it as the seed pixel.

2. Drag the intersection of the inquire cursor to a dark red area in the **germtm.img** file in the Viewer. This is also a forest area.
3. In the Region Growing Properties dialog, click **Grow at Inquire**. Wait for the polygon to open.
4. After the AOI is created, click on the Create New Signature(s) from AOI icon in the Signature Editor to add this AOI as a signature.



5. In the Signature Editor, click inside the **Signature Name** column for the signature you just added. Change the name to **Forest\_2**, then press Return on the keyboard.
6. In the Signature Editor, hold in the **Color** column next to **Forest\_2** and select **Pink**.
7. Click **Close** in the Inquire Cursor dialog and the Region Growing Properties dialog.

### Arrange Layers

1. Now that you have the parametric signatures collected, you do not need the AOIs in the Viewer. Select **View | Arrange Layers** from the Viewer menu bar.

The Arrange Layers dialog opens.



## Advanced Classification

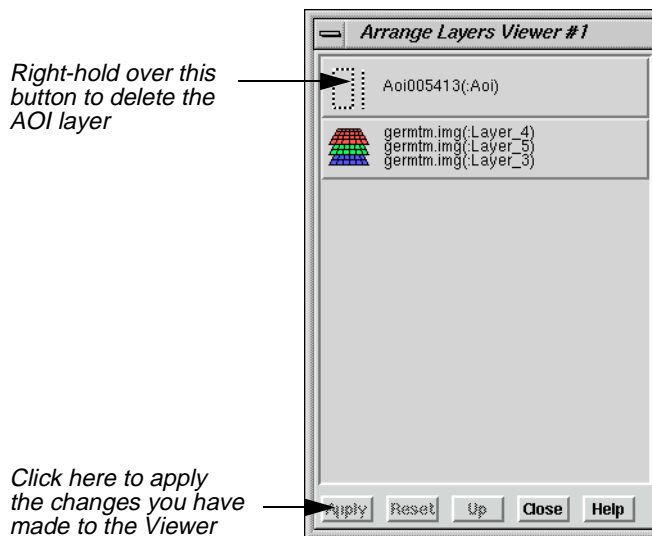

2. In the Arrange Layers dialog, right-hold over the **AOI Layer** button and select **Delete Layer** from the **AOI Options** menu.
3. Click **Apply** in the Arrange Layers dialog to delete the AOI layer.
4. You are asked if you want to save the changes before closing. Click **No**.
5. In the Arrange Layers dialog, click **Close**.

### Create Feature Space Image

The ERDAS IMAGINE Feature Space tools allow you to interactively define areas of interest (polygons or rectangles) in the Feature Space image(s). A Feature Space signature (nonparametric) is based on the AOI(s) in the Feature Space image. Use this technique to extract a signature for water.

1. Select **Feature | Create | Feature Space Layers** from the Signature Editor menu bar.

The Create Feature Space Images dialog opens.



## Perform Supervised Classification

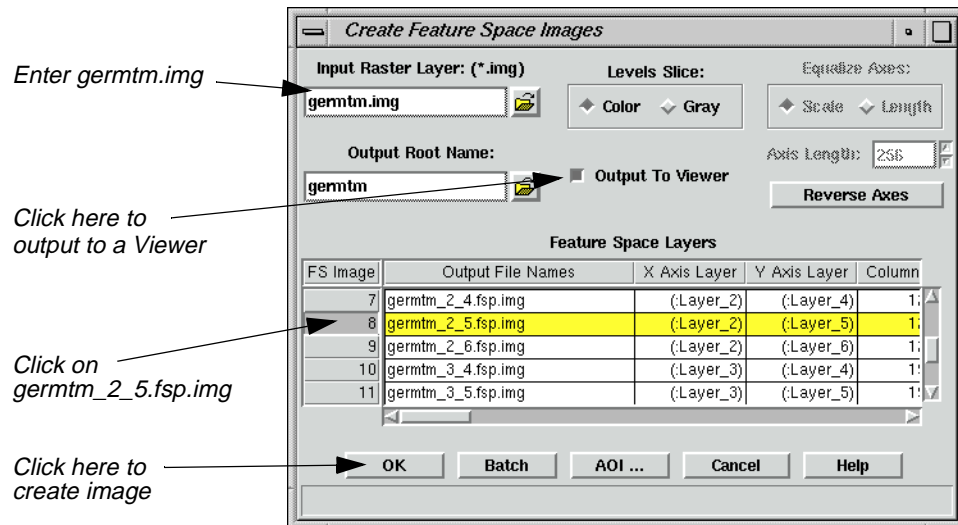

- In the Create Feature Space Images dialog under **Input Raster Layer**, enter **germtm.img**. This is the image file from which the Feature Space image is generated.

Under **Output Root Name**, the default name is **germtm**. This is the root name for the Feature Space image files that are generated.



Verify that the directory where the Feature Space image files are saved has write permission.

- In the Create Feature Space Images dialog, click the **Output to Viewer** option so that the Feature Space image is displayed in a Viewer.
- Under **Feature Space Layers**, click the number **8** in the **FS Image** column in the CellArray to select the **germtm\_2\_5.fsp.img** row. (You may need to scroll down to get to **FS Image** number **8**.)

The output Feature Space image is based on layers two and five of the **germtm.img** file. Layers two and five are selected since water is spectrally distinct in this band combination.

- Click **OK** in the Create Feature Space Images dialog to create the Feature Space image for layers two and five of the **germtm.img** file.

The Create Feature Space Images dialog closes, then the Job Status dialog opens.

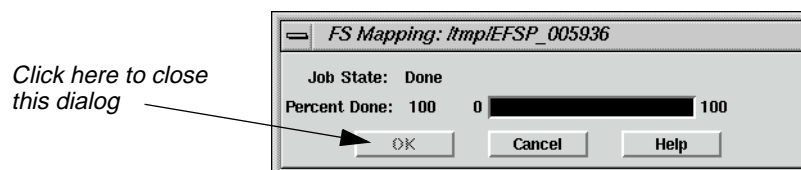

## Advanced Classification

After the process is completed, a Viewer (Viewer #2) opens, displaying the Feature Space image.

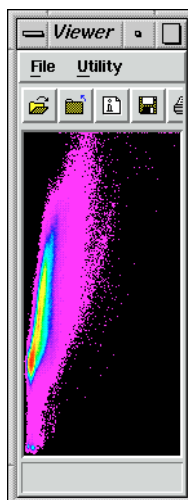

6. Click **OK** in the Job Status dialog to close this dialog.

### Link Cursors in Image/Feature Space

The Linked Cursors utility allows you to directly link a cursor in the image Viewer to the Feature Space viewer. This shows you where pixels in the image file are located in the Feature Space image.

1. In the Signature Editor, select **Feature | View | Linked Cursors**.

The Linked Cursors dialog opens.

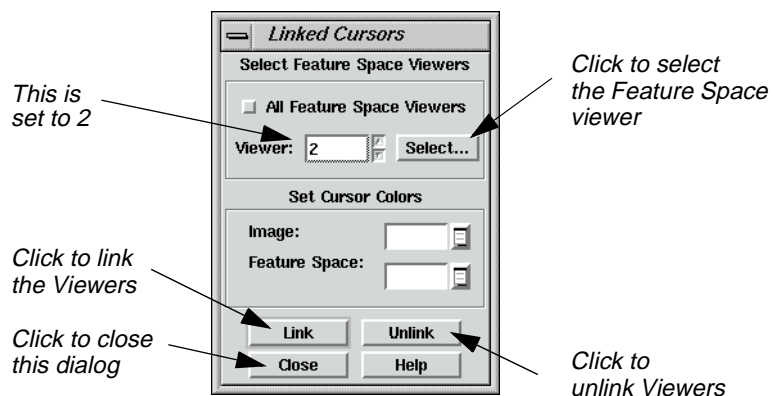

2. Click **Select** in the Linked Cursors dialog to define the Feature Space viewer that you want to link to the Image Viewer.
3. Click in Viewer #2 (the Viewer displaying the Feature Space image).

## Perform Supervised Classification

The **Viewer** number field in the Linked Cursors dialog changes to **2**. You could also enter a **2** in this number field without having to click the **Select** button.

4. In the Linked Cursors dialog, click **Link** to link the Viewers, then click in the Viewer displaying **germtm.img**.

The linked inquire cursors (white crosshairs) open in the Viewers.

5. Drag the inquire cursor around in the **germtm.img** Viewer (Viewer #1) to see where these pixels are located in the Feature Space image. Notice where the water areas are located in the Feature Space image. These areas are black in the **germtm.img** file (Viewer #1).

### Define Feature Space Signature

Any Feature Space AOI can be defined as a nonparametric signature in your classification.

1. Use the polygon AOI tool to draw a polygon in the Feature Space image. Draw the polygon in the area that you identified as water. You may need to zoom in on the images (i.e., zoom in on either or both the Feature Space image or **germtm.img**) to draw the polygon. The Feature Space signature is based on this polygon.

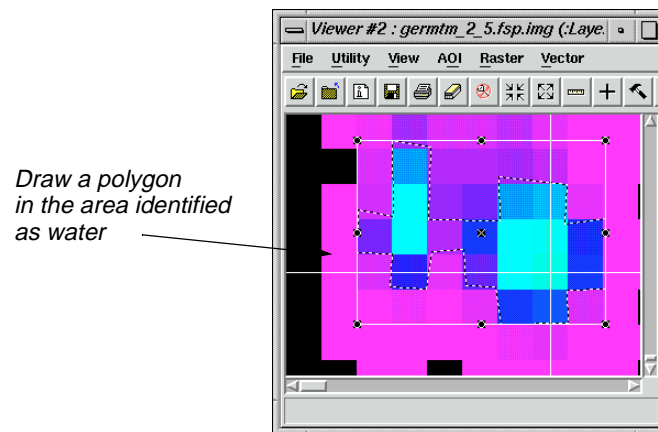

2. After the AOI is created, click on the Create New Signature(s) from AOI icon in the Signature Editor to add this AOI as a signature.



3. The signature you have just added is a nonparametric signature. Select **Feature | Statistics** from the Signature Editor menu bar to generate statistics for the Feature Space AOI.

A Job Status dialog displays, stating the progress of the function.

4. When the function is 100% complete, click **OK** in the Job Status dialog.

The Feature Space AOI now has parametric properties.

## Advanced Classification

5. In the Signature Editor, click inside the **Signature Name** column for the signature you just added. Change the name to **Water**, then press the Return key on the keyboard.
6. In the Signature Editor, hold in the **Color** column next to **Water** and select **Blue**.
7. In the Linked Cursors dialog, click **Unlink** to unlink the viewers.  
The inquire cursors are removed from the viewers.
8. In the Linked Cursors dialog, click **Close**.
9. Now that you have the nonparametric signature collected, you do not need the AOI in the Feature Space viewer. Select **View | Arrange Layers** from the Viewer #2 menu bar.  
The Arrange Layers dialog opens.
10. In the Arrange Layers dialog, right-hold over the **AOI Layer** button and select **Delete Layer** from the AOI Options popup list.
11. Click **Apply** in the Arrange Layers dialog to delete the AOI layer.
12. You are asked if you want to save the changes before closing. Click **No**.
13. In the Arrange Layers dialog, click **Close**.
14. Practice taking additional signatures using any of the signature-generating techniques you have learned in the steps above. Extract at least five signatures.
15. After you have extracted all the signatures you wish, select **File | Save As** from the Signature Editor menu bar.  
The Save Signature File As dialog opens.
16. Use the Save Signature File As dialog to save the signature set in the Signature Editor (e.g., **germtm\_sigid.sig**).
17. Click **OK** in the Save Signature File As dialog.

### Use Tools to Evaluate Signatures

Once signatures are created, they can be evaluated, deleted, renamed, and merged with signatures from other files. Merging signatures allows you to perform complex classifications with signatures that are derived from more than one training method (supervised and/or unsupervised, parametric and nonparametric).

Next, the following tools for evaluating signatures are discussed:

- alarms
- contingency matrix
- feature space to image masking
- signature objects
- histograms
- signature separability
- statistics



---

*When you use one of these tools, you need to select the appropriate signature(s) to be used in the evaluation. For example, you cannot use the signature separability tool with a nonparametric (Feature Space) signature.*



# Advanced Classification

## Prepare

You should have at least ten signatures in the Signature Editor, similar to the following:

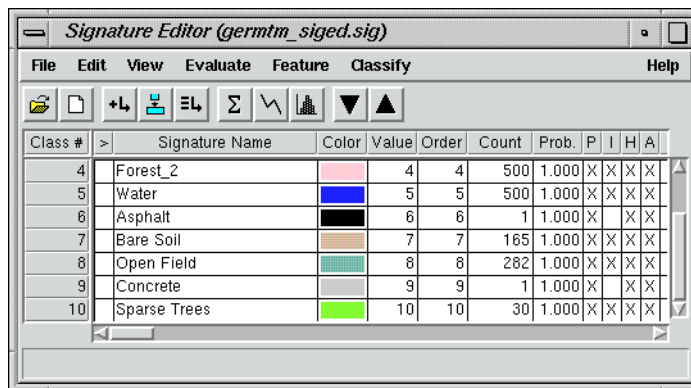

## Set Alarms

The Signature Alarm utility highlights the pixels in the Viewer that belong to, or are estimated to belong to a class according to the parallelepiped decision rule. An alarm can be performed with one or more signatures. If you do not have any signatures selected, then the active signature, which is next to the >, is used.

1. In the Signature Editor, select **Forest\_1** by clicking in the > column for that signature. The alarm is performed with this signature.
2. In the Signature Editor menu bar, select **View | Image Alarm**.

The Signature Alarm dialog opens.

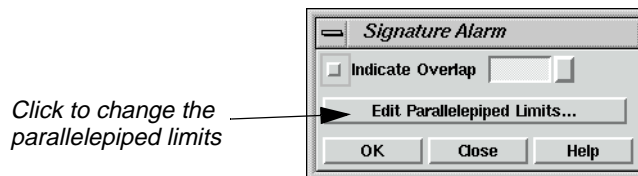

3. Click **Edit Parallelepiped Limits** in the Signature Alarm dialog to view the limits for the parallelepiped.

The Limits dialog opens.

4. In the Limits dialog, click **Set** to define the parallelepiped limits.

The Set Parallelepiped Limits dialog opens.

## Perform Supervised Classification

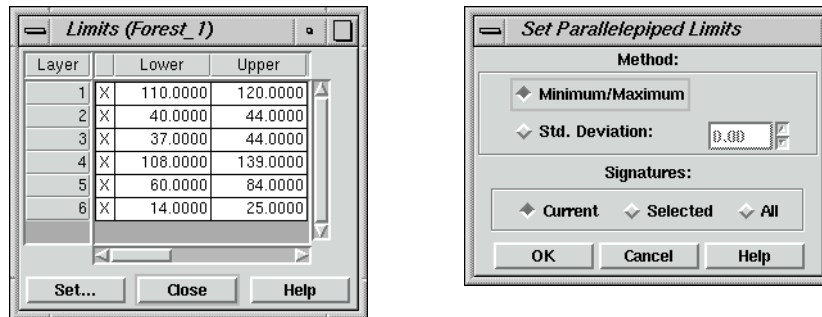

The Signature Alarm utility allows you to define the parallelepiped limits by either:

- the minimum and maximum for each layer in the signature, or
  - a specified number of standard deviations from the mean of the signature.
5. If you wish, you can set new parallelepiped limits and click **OK** in the Set Parallelepiped Limits dialog, or simply accept the default limits by clicking **OK** in the Set Parallelepiped Limits dialog.

The new/default limits display in the Limits CellArray.

6. Click **Close** in the Limits dialog.
7. In the Signature Alarm dialog, click **OK**.

The alarmed pixels display in the Viewer in yellow. You can use the toggle function (**Utility | Flicker**) in the Viewer to see how the pixels are classified by the alarm.



*Be sure that there are no AOI layers open on top of the Alarm Mask Layer. You can use **View | Arrange Layers** to remove any AOI layers present in the Viewer.*



## Advanced Classification

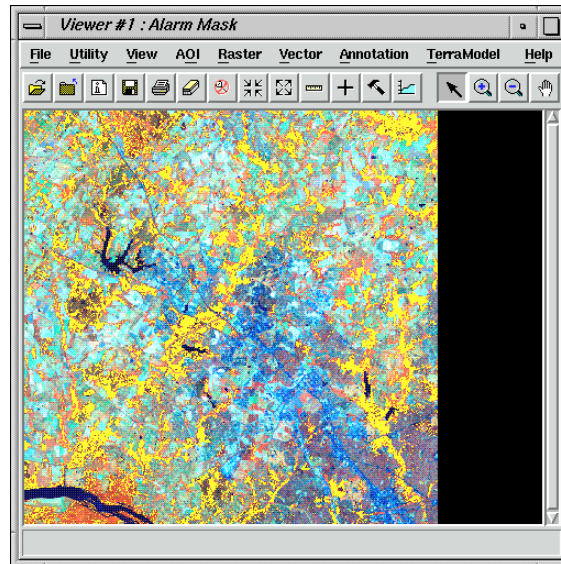

8. In the Signature Alarm dialog, click **Close**.
9. In the Viewer #1 menu bar, select **View | Arrange Layers**.  
The Arrange Layers dialog opens.
10. In the Arrange Layers dialog, right-hold over the **Alarm Mask** button and select **Delete Layer** from the **Layer Options** menu.
11. Click **Apply** to delete the alarm layer from the Viewer.
12. You are asked if you want to save the changes before closing. Click **No**.
13. In the Arrange Layers dialog, click **Close**.



### Evaluate Contingency

#### Contingency Matrix

The Contingency Matrix utility allows you to evaluate signatures that have been created from AOIs in the image. This utility classifies only the pixels in the image AOI training sample, based on the signatures. It is usually expected that the pixels of an AOI are classified to the class that they train. However, the pixels of the AOI training sample only weight the statistics of the signature. They are rarely so homogenous that every pixel actually becomes assigned to the expected class. The Contingency Matrix utility can be performed with multiple signatures. If you do not have any signatures selected, then all of the signatures are used.

The output of the Contingency Matrix utility is a matrix of percentages that allows you to see how many pixels in each AOI training sample were assigned to each class. In theory, each AOI training sample would be composed primarily of pixels that belong to its corresponding signature class.

The AOI training samples are classified using one of the following classification algorithms:

- parallelepiped
- feature space
- maximum likelihood
- Mahalanobis distance

*NOTE: The classification decision rule that is going to be used in the actual image classification should be determined so that it can also be used in the Contingency Matrix utility.*

1. In the Signature Editor, select all of the signatures by Shift-clicking in the first row of the **Class** column and then dragging down through the other classes.
2. In the Signature Editor menu bar, select **Evaluate | Contingency**.

The Contingency Matrix dialog opens.



## Advanced Classification

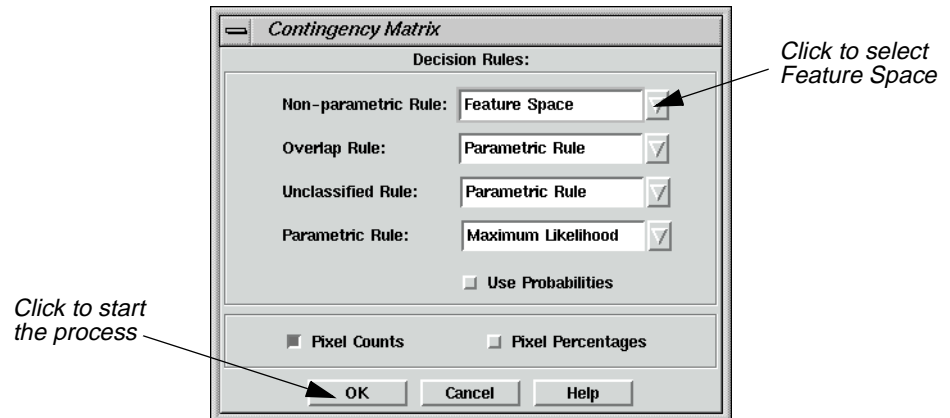

3. In the Contingency Matrix dialog, click on the **Non-parametric Rule** popup list and select **Feature Space**.



See "CHAPTER 6: Classification" of the *ERDAS Field Guide* for more information on decision rules.

4. Click **OK** in the Contingency Matrix dialog to start the process.  
A Job Status dialog displays, stating the progress of the function.
5. When the process is 100% complete, click **OK** in the Job Status dialog.  
The IMAGINE Text Editor opens (labelled **Editor, Dir**), displaying the error matrix.
6. After viewing the reference data in the Text Editor, select **File | Close** from the menu bar.
7. Deselect the signatures that were selected by right-clicking in the **Class** column and choosing **Select None** from the **Row Selection** menu.

### Generate a Mask from a Feature Space Signature

The Feature Space to Image Masking utility allows you to generate a mask from a Feature Space signature (i.e., the AOI in the Feature Space image). Once the Feature Space signature is defined as a mask, the pixels under the mask are identified in the image file and highlighted in the Viewer. This allows you to view which pixels would be assigned to the Feature Space signature's class. A mask can be generated from one or more Feature Space signatures. If you do not have any signatures selected, then the active signature, which is next to the **>**, is used.

The image displayed in Viewer #1 must be the image from which the Feature Space image was created.

1. In the Signature Editor, select **Feature | Masking | Feature Space to Image**.

The FS to Image Masking dialog opens.

## Perform Supervised Classification

*This checkbox should be turned off (disabled)*

*Click to create the mask*

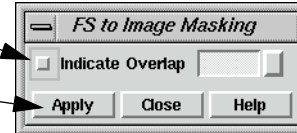

2. In the Signature Editor, click in the **Class** row for **Water** to select that signature.

The mask is generated from this Feature Space signature.

3. Disable the Indicate Overlap checkbox, and click **Apply** in the FS to Image Masking dialog to generate the mask in Viewer #1.

A mask is placed in the Viewer.

4. In the FS to Image Masking dialog, click **Close**.

5. Deselect the **Water** feature.

### View Signature Objects

The Signature Objects dialog allows you to view graphs of signature statistics so that you can compare signatures. The graphs display as sets of ellipses in a Feature Space image. Each ellipse is based on the mean and standard deviation of one signature. A graph can be generated for one or more signatures. If you do not have any signatures selected, then the active signature, which is next to the >, is used. This utility also allows you to show the mean for the signature for the two bands, a parallelepiped, and a label.

1. In the Signature Editor menu bar, select **Feature | Objects**.

The Signature Objects dialog opens.

*Enter 2 here*

*Enter 4 here*

*Click here to start the process*

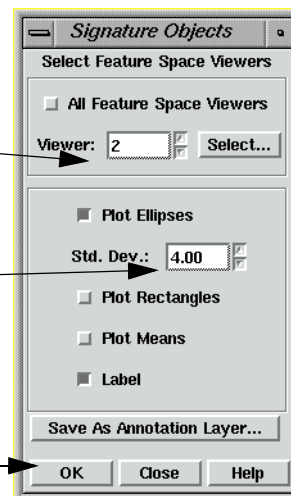

## Advanced Classification

2. In the Signature Editor, select the signatures for **Agricultural Field\_1** and **Forest\_1** by clicking in the **Class** row for **Agricultural Field\_1** and Shift-clicking in the **Class** row for **Forest\_1**.
3. In the Signature Objects dialog, confirm that the **Viewer** number field is set for **2**.
4. Set the **Std. Dev.** number field to **4**.
5. Enable the **Label** checkbox by clicking on it.
6. Click **OK** in the Signature Objects dialog.

The ellipses for the **Agricultural Field\_1** and **Forest\_1** signatures are displayed in the Feature Space viewer.

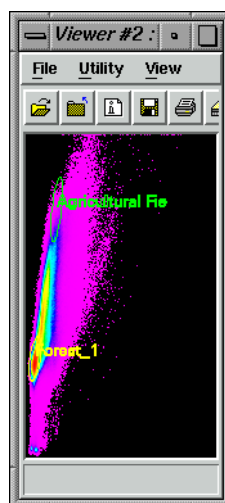

### *Compare Ellipses*

By comparing the ellipses for different signatures for a one band pair, you can easily see if the signatures represent similar groups of pixels by seeing where the ellipses overlap on the Feature Space image.

- When ellipses do not overlap, the signatures represent a distinct set of pixels in the two bands being plotted, which is desirable for classification. However, some overlap is expected, because it is rare that all classes are totally distinct.

When the ellipses do overlap, then the signatures represent similar pixels, which is not desirable for classification.

7. In the Signature Objects dialog, click **Close**.
8. Deselect the signatures for **Agricultural Field\_1** and **Forest\_1**.



## Perform Supervised Classification

### Plot Histograms

The Histogram Plot Control Panel allows you to analyze the histograms for the layers to make your own evaluations and comparisons. A histogram can be created with one or more signatures. If you create a histogram for a single signature, then the active signature, which is next to the >, is used. If you create a histogram for multiple signatures, then the selected signatures are used.

1. In the Signature Editor, move the > prompt to the signature for **Agricultural Field\_1** by clicking under the > column.
2. In the Signature Editor menu bar, select **View | Histograms** or click on the Histogram icon.



The Histogram Plot Control Panel and the Histogram dialogs open.

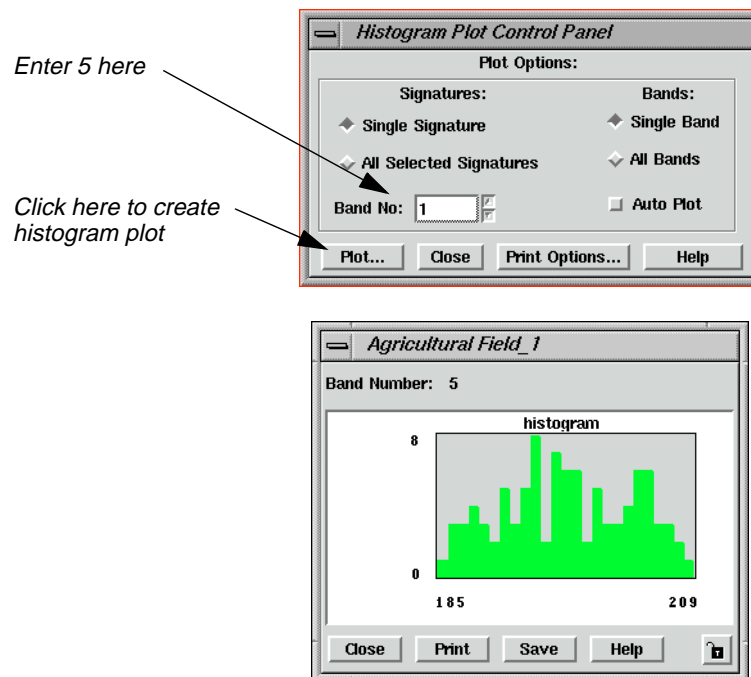

3. In the Histogram Plot Control Panel dialog, change the **Band No** number field to **5** in order to view the histogram for band 5 (i.e., layer 5).
4. Click **Plot**.

The Histogram dialog changes to display the histogram for band 5. You can change the different plot options and select different signatures to see the differences in histograms for various signatures and bands.

5. In the Histogram Plot Control Panel dialog, click **Close**. The two Histogram dialogs close.

# Advanced Classification

## Compute Signature Separability

The Signature Separability utility computes the statistical distance between signatures. This distance can be used to determine how distinct your signatures are from one another. This utility can also be used to determine the best subset of layers to use in the classification.

The distances are based on the following formulas:

- euclidean spectral distances between their means
- Jeffries-Matusita distance
- divergence
- transformed divergence

The Signature Separability utility can be performed with multiple signatures. If you do not have any signatures selected, then all of the parametric signatures are used.

1. In the Signature Editor, select all of the parametric signatures.
2. In the Signature Editor menu bar, select **Evaluate | Separability**.

The Signature Separability dialog opens.

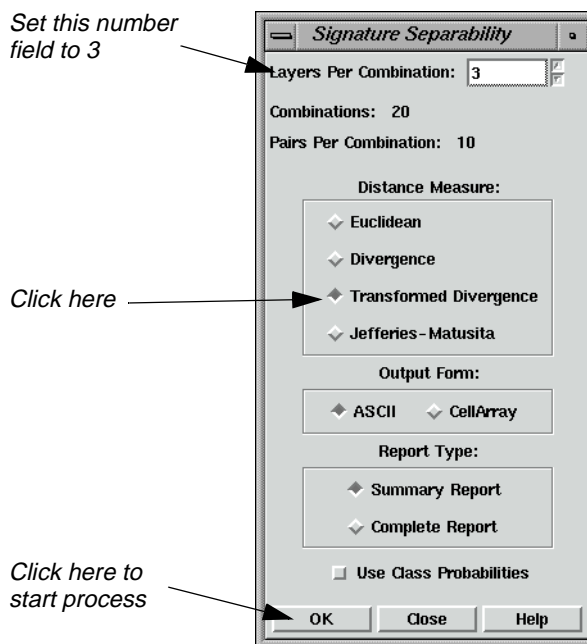

3. In the Signature Separability dialog, set the **Layers Per Combination** number field to **3**, so that three layers are used for each combination.
4. Click **Transformed Divergence** under **Distance Measure** to use the divergence algorithm for calculating the separability.

## Perform Supervised Classification

5. Confirm that the **Summary Report** checkbox is turned on under **Report Type**, in order to output a summary of the report.

The summary lists the separability listings for only those band combinations with best average and best minimum separability.

6. In the Signature Separability dialog, click **OK** to begin the process.

When the process is complete, the IMAGINE Text Editor opens, displaying the report.

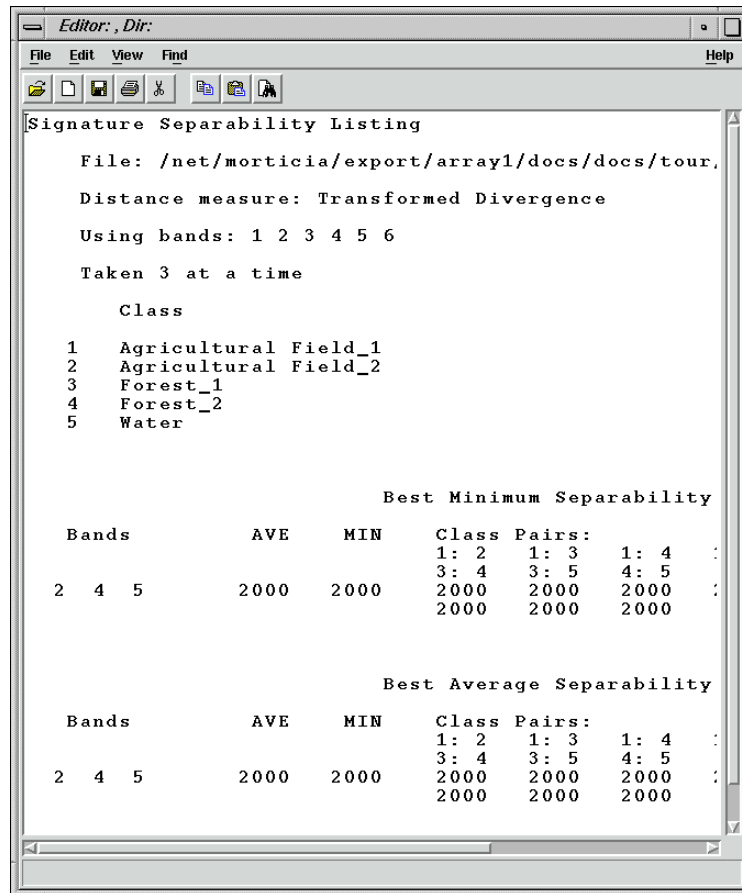

```
Editor: , Dir:
File Edit View Find Help
Signature Separability Listing
File: /net/morticia/export/array1/docs/docs/tour.
Distance measure: Transformed Divergence
Using bands: 1 2 3 4 5 6
Taken 3 at a time
Class
1 Agricultural Field_1
2 Agricultural Field_2
3 Forest_1
4 Forest_2
5 Water
Best Minimum Separability
Bands AVE MIN Class Pairs:
2 4 5 2000 2000 1: 2 1: 3 1: 4 :
3: 4 3: 5 4: 5 :
2000 2000 2000 :
2000 2000 2000
Best Average Separability
Bands AVE MIN Class Pairs:
2 4 5 2000 2000 1: 2 1: 3 1: 4 :
3: 4 3: 5 4: 5 :
2000 2000 2000 :
2000 2000 2000
```

This report shows that layers (i.e., bands) 2, 4, and 5 are the best layers to use for identifying features.

7. In the Text Editor menu bar, select **File | Close** to close the Editor.
8. In the Signature Separability dialog, click **Close**.



# Advanced Classification

## Check Statistics

The Statistics utility allows you to analyze the statistics for the layers to make your own evaluations and comparisons. Statistics can be generated for one signature at a time. The active signature, which is next to the >, is used.

1. In the Signature Editor, move the > prompt to the signature for **Forest\_1**.
2. In the Signature Editor menu bar, select **View | Statistics** or click on the Statistics icon.



The Statistics dialog opens.

Univariate				
Layer	Minimum	Maximum	Mean	Std. Dev.
1	110.000	120.000	114.550	1.455
2	40.000	44.000	41.920	0.723
3	37.000	44.000	39.338	0.983
4	108.000	139.000	122.074	6.385

Covariance				
Layer	1	2	3	4
1	2.116	0.216	0.261	0.326
2	0.216	0.523	0.203	0.200
3	0.261	0.203	0.966	-0.783
4	0.326	0.200	-0.783	40.770

3. After viewing the information in the Statistics dialog, click **Close**.

## Perform Supervised Classification

The decision rules for the supervised classification process are multilevel:

- nonparametric
- parametric

In this example, use both nonparametric and parametric decision rules.



See "CHAPTER 6: Classification" of the *ERDAS Field Guide* for more information on decision rules.



### Nonparametric

If the signature is nonparametric (i.e., Feature Space AOI), then the following decision rules are offered:

- feature space
- parallelepiped

With nonparametric signatures you must also decide the overlap rule and the unclassified rule.

*NOTE: All signatures have a nonparametric definition, due to their parallelepiped boundaries.*

### Parametric

For parametric signatures, the following decision rules are provided:

- maximum likelihood
- Mahalanobis distance
- minimum distance

In this tour guide, use the maximum likelihood decision rule.

### Output File

The Supervised Classification utility outputs a thematic raster layer (.img extension) and/or a distance file (.img extension). The distance file can be used for post-classification thresholding. The thematic raster layer automatically contains the following data:

- class values
- class names
- color table
- statistics
- histogram

The image file also contains any signature attributes that were selected in the Supervised Classification utility.

1. In the Signature Editor, select all of the signatures so that they are all used in the classification process (if none of the signatures are selected, then they are all used by default.)
2. In the Signature Editor menu bar, select **Classify | Supervised** to perform a supervised classification.

*NOTE: You may also access the Supervised Classification utility from the Classification dialog.*

The Supervised Classification dialog opens.



## Advanced Classification

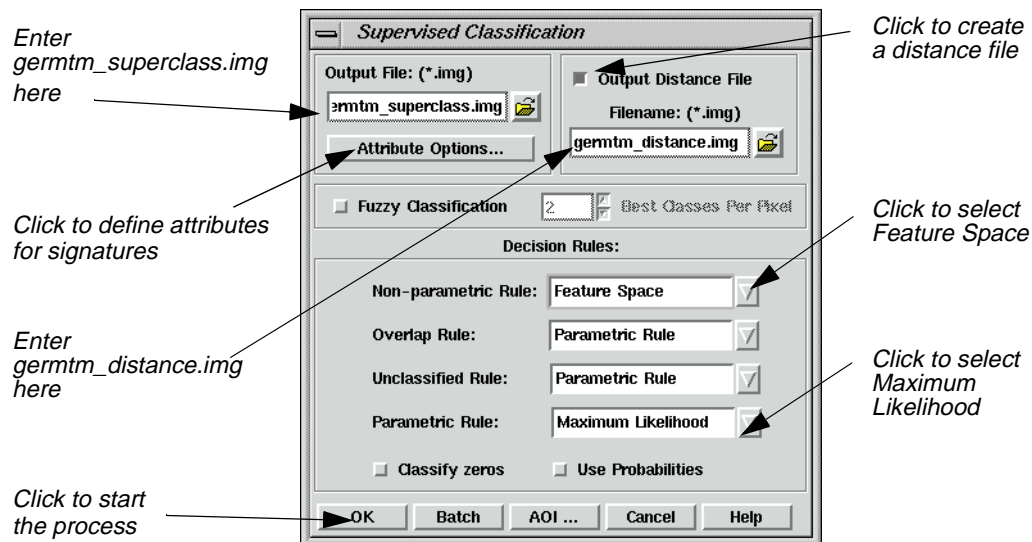

3. In the Supervised Classification dialog, under **Output File**, type in **germtm\_superclass.img**.

This is the name for the thematic raster layer.

4. Click the **Output Distance File** checkbox to activate it.

In this example, you are creating a distance file that can be used to threshold the classified image file.

5. Under **Filename**, enter **germtm\_distance.img** in the directory of your choice.

This is the name for the distance image file.

*NOTE: Make sure you remember the directory in which the output file is saved. It is important when you are trying to display the output file in a Viewer.*

### Select Attribute Options

1. In the Supervised Classification dialog, click **Attribute Options**.

The Attribute Options dialog opens.

## Perform Supervised Classification

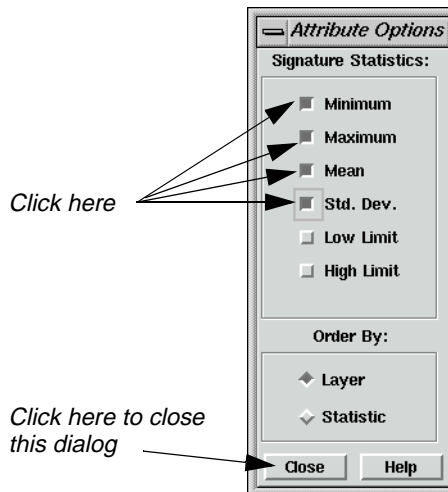

The Attribute Options dialog allows you to specify the statistical information for the signatures that you want to be in the output classified layer. The statistics are based on the data file values for each layer for the signatures, not the entire classified image file. This information is located in the Raster Attribute Editor.

2. In the Attribute Options dialog, click **Minimum**, **Maximum**, **Mean**, and **Std. Dev.**, so that the signatures in the output thematic raster layer have this statistical information.
3. Confirm that the **Layer** checkbox is turned on, so that the information is presented in the Raster Attribute Editor by layer.
4. In the Attribute Options dialog, click **Close** to remove this dialog.

### Classify the Image

1. In the Supervised Classification dialog, click on the **Non-parametric Rule** popup list to select **Feature Space**.

You do not need to use the **Classify Zeros** option here because there are no background zero data file values in the **germtm.img** file.

2. Click **OK** in the Supervised Classification dialog to classify the **germtm.img** file using the signatures in the Signature Editor.

A Job Status dialog displays, indicating the progress of the function.

3. When the process is 100% complete, click **OK** in the Job Status dialog.



*See "CHAPTER 6: Classification" of the ERDAS Field Guide for information on how the pixels are classified.*

4. Select **File | Close** from the Signature Editor menu bar and from the Viewer #2 menu bar. Click **Yes** when asked if you would like to save the changes to the Signature Editor.



## Advanced Classification

5. Click **Close** in the Raster tool palette.
6. Select **File | Clear** from the Viewer #1 menu bar.
7. Proceed to the:
  - “Perform Unsupervised Classification” section on page 484 to classify the same image using the ISODATA algorithm.
  - “Evaluate Classification” section on page 487 to analyze the classes and test the accuracy of the classification, or

The super classification image is pictured on the left, and the distance image is pictured on the right.

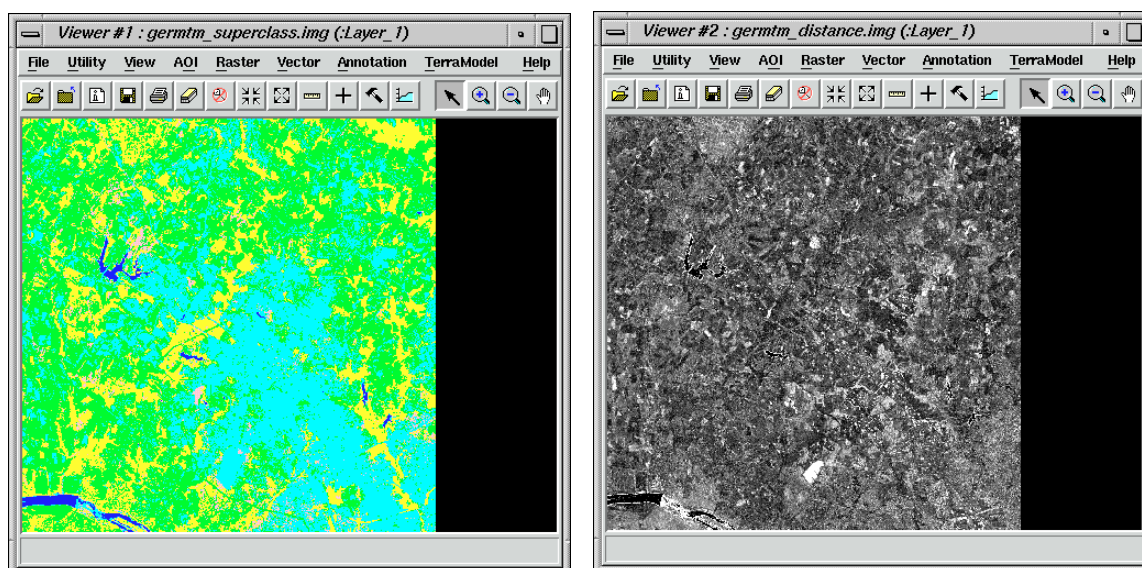

### Perform Unsupervised Classification

This section shows you how to create a thematic raster layer by letting the software identify statistical patterns in the data without using any ground truth data.

ERDAS IMAGINE uses the ISODATA algorithm to perform an unsupervised classification. The ISODATA clustering method uses the minimum spectral distance formula to form clusters. It begins with either arbitrary cluster means or means of an existing signature set, and each time the clustering repeats, the means of these clusters are shifted. The new cluster means are used for the next iteration.

The ISODATA utility repeats the clustering of the image until either a maximum number of iterations has been performed, or a maximum percentage of unchanged pixel assignments has been reached between two iterations.

Performing an unsupervised classification is simpler than a supervised classification, because the signatures are automatically generated by the ISODATA algorithm.

In this example, you generate a thematic raster layer using the ISODATA algorithm.

## Perform Unsupervised Classification

### Prepare

You must have ERDAS IMAGINE running.

1. Click on the Classifier icon in the ERDAS IMAGINE icon panel to start the Classification utility.



The **Classification** menu opens.

*Click here to start  
the Unsupervised  
Classification utility*

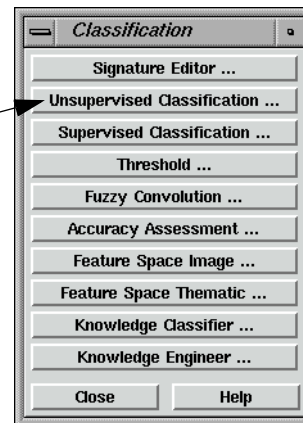

### Generate Thematic Raster Layer

1. Select **Unsupervised Classification** from the **Classification** menu to perform an unsupervised classification using the ISODATA algorithm.

The Unsupervised Classification dialog opens.



## Advanced Classification

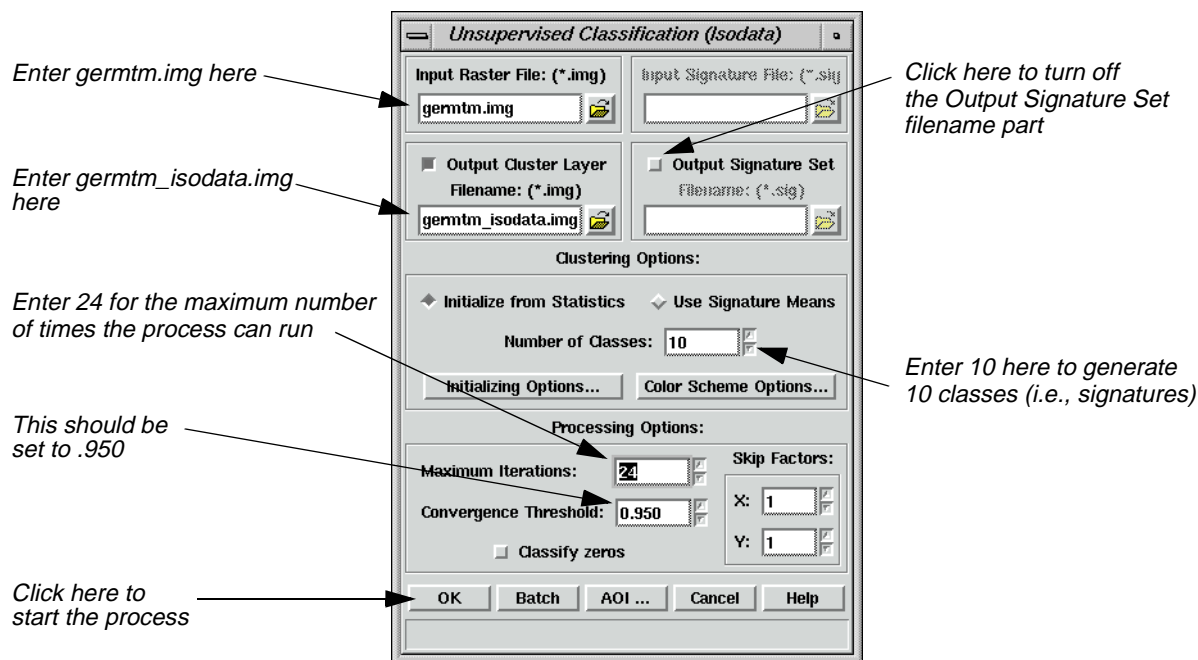

2. Click **Close** in the **Classification** menu to clear it from the screen.
3. In the Unsupervised Classification dialog under **Input Raster File**, enter **germtm.img**. This is the image file that you are going to classify.
4. Under **Output Cluster Layer**, enter **germtm\_isodata.img** in the directory of your choice.  
This is the name for the output thematic raster layer.
5. Click **Output Signature Set** to turn off the checkbox.

For this example, do not create a signature set. The **Output Signature Set** filename part is disabled.

### Set Initial Cluster Options

The **Clustering Options** allow you to define how the initial clusters are generated.

1. Confirm that the **Initialize from Statistics** checkbox under **Clustering Options** is turned on.

This generates arbitrary clusters from the file statistics for the image file.

2. Enter a **10** in the **Number of Classes** number field.

### Set Processing Options

The Processing Options allow you to specify how the process is performed.

1. Enter **24** in the **Maximum Iterations** number field under **Processing Options**.



This is the maximum number of times that the ISODATA utility reclusters the data. It prevents this utility from running too long, or from potentially getting stuck in a cycle without reaching the convergence threshold.

2. Confirm that the **Convergence Threshold** number field is set to **.95**.

### Convergence Threshold

The convergence threshold is the maximum percentage of pixels that has cluster assignments that can go unchanged between iterations. This threshold prevents the ISODATA utility from running indefinitely.

By specifying a convergence threshold of .95, you are specifying that as soon as 95% or more of the pixels stay in the same cluster between one iteration and the next, the utility should stop processing. In other words, as soon as 5% or fewer of the pixels change clusters between iterations, the utility stops processing.

3. Click **OK** in the Unsupervised Classification dialog to start the classification process. The Unsupervised Classification dialog closes automatically.  
  
A Job Status dialog displays, indicating the progress of the function.
4. Click **OK** in the Job Status dialog when the process is 100% complete.
5. Proceed to the Evaluate Classification section to analyze the classes so that you can identify and assign class names and colors.

---

## Evaluate Classification

After a classification is performed, the following methods are available for evaluating and testing the accuracy of the classification:

- classification overlay
- thresholding
- recode classes
- accuracy assessment



---

See "CHAPTER 6: Classification" of the *ERDAS Field Guide* for information on thresholding and accuracy assessment.

## Create Classification Overlay

In this example, use the Raster Attribute Editor to compare the original image data with the individual classes of the thematic raster layer that was created from the unsupervised classification (**germtm\_isodata.img**). This process helps identify the classes in the thematic raster layer. You may also use this process to evaluate the classes of a thematic layer that was generated from a supervised classification.

### Prepare

ERDAS IMAGINE should be running and you should have a Viewer open.



# Advanced Classification

## Display Files

1. Select **File | Open | Raster Layer** from the Viewer menu bar or click the Open icon in the tool bar to display the **germtm.img** continuous raster layer.



The Select Layer To Add dialog opens.

Click on this file tab to see the raster options

Click here to select germtm.img

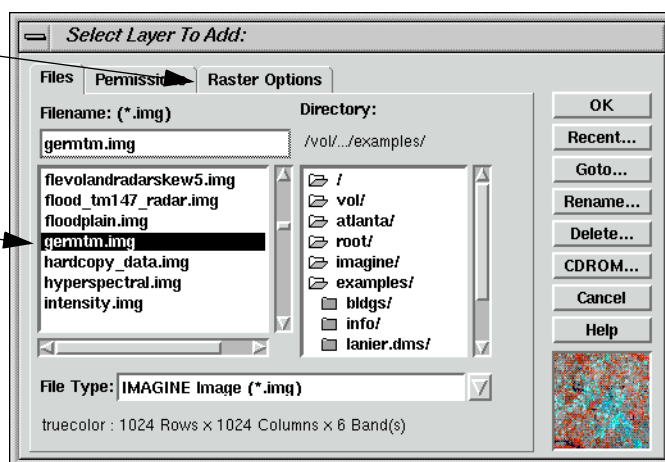

2. In the Select Layer To Add dialog under **Filename**, select **germtm.img**.
3. Click the **Raster Options** tab at the top of the Select Layer To Add dialog.
4. Set **Layers to Colors** at **4, 5, and 3**, respectively.
5. Click **OK** in the Select Layer To Add dialog to display the image file.



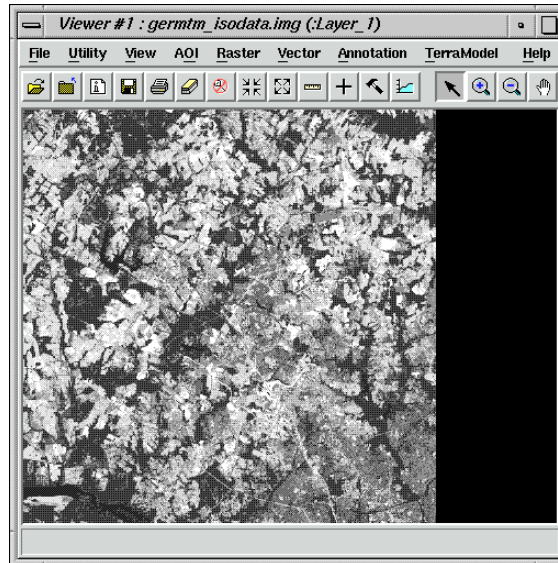

6. Click the Open icon again in the Viewer tool bar to display the thematic raster layer, **germtm\_isodata.img**, over the **germtm.img** file.

The Select Layer To Add dialog reopens.

7. Under **Filename**, open the directory in which you previously saved **germtm\_isodata.img** by entering the directory path name in the text entry field and pressing the Return key on your keyboard.

You are going to evaluate/identify the classes in this file.

8. Select the file **germtm\_isodata.img** from the list of files in the directory you just opened.
9. Click the **Raster Options** tab at the top of the Select Layer To Add dialog.
10. Click **Clear Display** to turn off this checkbox.
11. Click **OK** in the Select Layer To Add dialog to display the image file.

### Open Raster Attribute Editor

1. Select **Raster | Attributes** from the Viewer menu bar.

The Raster Attribute Editor displays.

2. In the Raster Attribute Editor, select **Edit | Column Properties** to rearrange the columns in the CellArray so that they are easier to view.

The Column Properties dialog opens.



## Advanced Classification

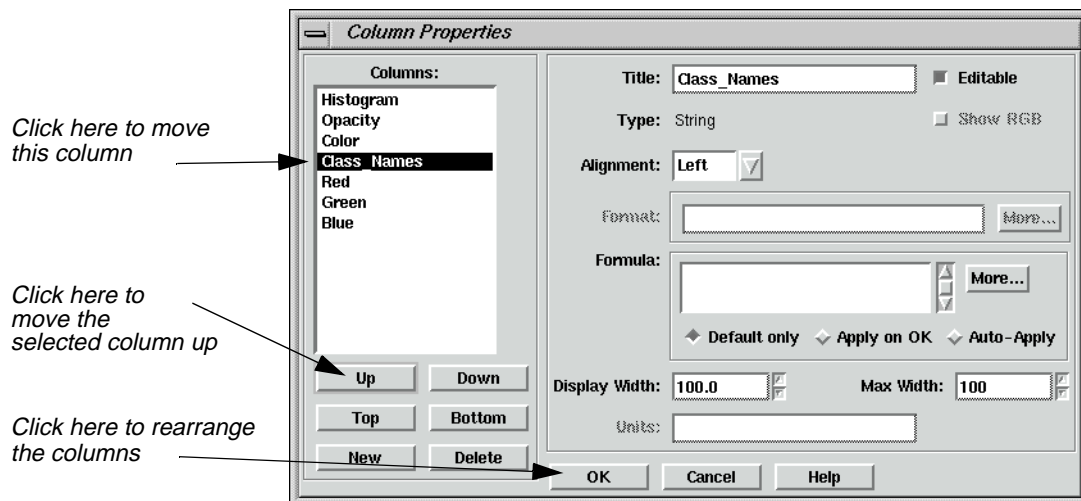

3. In the Column Properties dialog under **Columns**, select **Opacity**, then click **Up** to move **Opacity** so that it is under **Histogram**.
4. Select **Class\_Names**, then click **Up** to move **Class\_Names** so that it is under **Color**.
5. Click **OK** in the Column Properties dialog to rearrange the columns in the Raster Attribute Editor.

The Column Properties dialog closes.

The data in the Raster Attribute Editor CellArray should appear similar to the following example:

Row	Histogram	Opacity	Color	
0	0	1	█	Unclassified
1	13315	1	█	Class 1
2	249857	1	█	Class 2
3	112489	1	█	Class 3
4	80585	1	█	Class 4
5	102708	1	█	Class 5
6	121459	1	█	Class 6
7	66616	1	█	Class 7
8	140930	1	█	Class 8

### Analyze Individual Classes

Before you can begin to analyze the classes individually, you need to set the opacity for all of the classes to zero.

1. In the Raster Attribute Editor, click on the word **Opacity** at the top of the **Opacity** column to select all of the classes.



- In the Raster Attribute Editor, right-hold on the word **Opacity** at the top of the **Opacity** column and select **Formula** from the **Column Options** menu.

The Formula dialog opens.

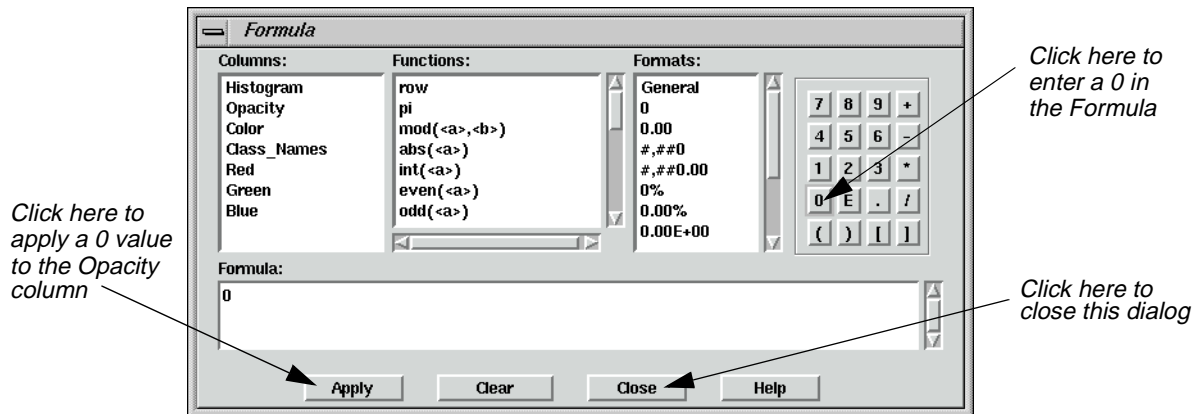

- In the Formula dialog, click **0** in the number pad.

A **0** is placed in the **Formula** field.

- In the Formula dialog, click **Apply** to change all of the values in the **Opacity** column to **0**, and then click **Close**.
- In the Raster Attribute Editor, hold on the color patch under **Color** for **Class 1** in the CellArray and change the color to **Yellow**. This provides better visibility in the Viewer.
- Change the **Opacity** for **Class 1** in the CellArray to **1** and then press Return on the keyboard. This class is shown in the Viewer.
- In the Viewer menu bar, select **Utility | Flicker** to analyze which pixels have been assigned to this class.

The Viewer Flicker dialog opens.

- Turn on the **Auto Mode** in the Viewer Flicker dialog.

The flashing black pixels in the **germtm.img** file are the pixels of this class. These areas are water.

- In the Raster Attribute Editor, click inside the **Class\_Names** column for **Class 1**. Change this name to **Water** and then press the Return key on the keyboard.
- In the Raster Attribute Editor, hold on the **Color** patch for **Water**. Select **Blue** from the popup list.
- After you are finished analyzing this class, click **Cancel** in the Viewer Flicker dialog and set the **Opacity** for **Water** back to **0**. Press the Return key on the keyboard.
- Change the **Color** for **Class 2** in the CellArray to **Yellow** for better visibility in the Viewer.



## Advanced Classification

13. Change the **Opacity** for **Class 2** to **1** and press the Return key on the keyboard. This class is shown in the Viewer.

### Use the Flicker Utility

1. In the Viewer menu bar, select **Utility | Flicker** to analyze which pixels were assigned to this class.

The Viewer Flicker dialog opens.

2. Turn on the **Auto Mode** in the Viewer Flicker dialog.

The flashing red pixels in the **germtm.img** file should be the pixels of this class. These are forest areas.

3. In the Raster Attribute Editor, click inside the **Class\_Names** column for **Class 2**. (You may need to double-click in the column.) Change this name to **Forest**, then press the Return key on the keyboard.
4. In the Raster Attribute Editor, hold on the **Color** patch for **Forest** and select **Pink** from the popup list.
5. After you are finished analyzing this class, click **Cancel** in the Viewer Flicker dialog and set the **Opacity** for **Forest** back to **0**. Press the Return key on the keyboard.
6. Repeat these steps with each class so that you can see how the pixels are assigned to each class. You may also try selecting more than one class at a time.
7. Continue assigning names and colors for the remaining classes in the Raster Attribute Editor CellArray.
8. In the Raster Attribute Editor, select **File | Save** to save the data in the CellArray.
9. Select **File | Close** from the Raster Attribute Editor menu bar.
10. Select **File | Clear** from the Viewer menu bar.

### Use Thresholding

The Thresholding utility allows you to refine a classification that was performed using the Supervised Classification utility. The Thresholding utility determines which pixels in the new thematic raster layer are most likely to be incorrectly classified.

This utility allows you to set a distance threshold for each class in order to screen out the pixels that most likely do not belong to that class. For all pixels that have distance file values greater than a threshold you set, the class value in the thematic raster layer is set to another value.

The threshold can be set:

- with numeric input, using chi-square statistics, confidence level, or Euclidean spectral distance, or
- interactively, by viewing the histogram of one class in the distance file while using the mouse to specify the threshold on the histogram graph.

Since the chi-square table is built-in, you can enter the threshold value in the confidence level unit and the chi-square value is automatically computed.



In this example, you threshold the output thematic raster layer from the supervised classification (**germtm\_superclass.img**).

### Prepare

ERDAS IMAGINE must be running and you must have **germtm\_superclass.img** displayed in a Viewer.

1. Click on the Classifier icon in the ERDAS IMAGINE icon panel to start the Classification utility.



The **Classification** menu displays.

2. Select **Threshold** from the **Classification** menu to start the Threshold dialog.

The Threshold dialog opens.

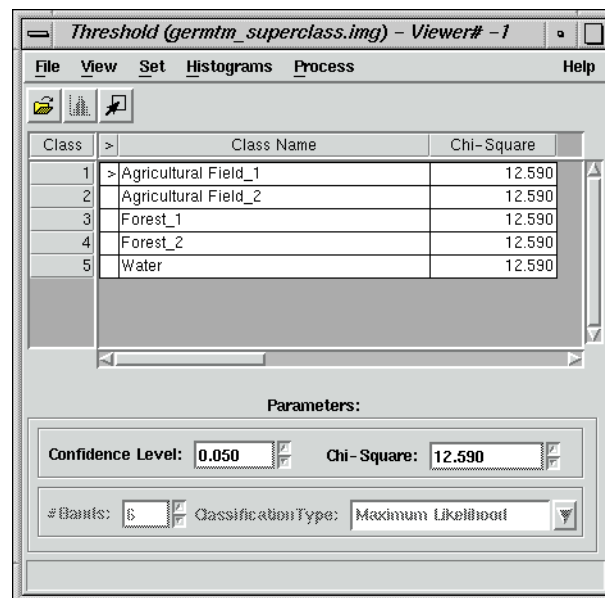

3. Click **Close** in the **Classification** menu to clear it from the screen.



## Advanced Classification

4. In the Threshold dialog, select **File | Open** or click the Open icon to define the classified image and distance image files.



The Open Files dialog opens.

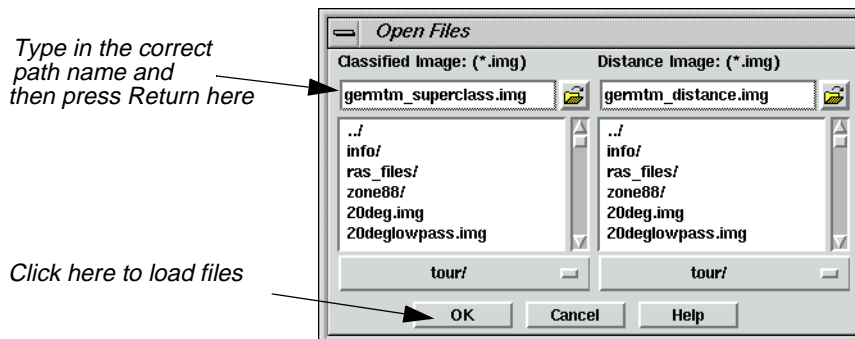

### Select Classified and Distance Images

1. In the Open Files dialog under **Classified Image**, open the directory in which you previously saved **germtm\_superclass.img** by entering the directory path name in the text window and pressing Return on your keyboard.
2. Select the file **germtm\_superclass.img** from the list of files in the directory you just opened.

This is the classified image file that is going to be thresholded.

3. In the Open Files dialog, under **Distance Image**, open the directory in which you previously saved **germtm\_distance.img** by entering the directory path name in the text entry field and pressing Return on your keyboard.
4. Select the file **germtm\_distance.img** from the list of files in the directory you just opened.

This is the distance image that was created when the **germtm\_superclass.img** file was created. A distance image file for the classified image is necessary for thresholding.

5. Click **OK** in the Open Files dialog to load the files.
6. In the Threshold dialog, select **View | Select Viewer** and then click in the Viewer that is displaying the **germtm\_superclass.img** file.

### Compute and Evaluate Histograms

1. In the Threshold dialog, select **Histograms | Compute**.

The histograms for the distance image file are computed. There is a separate histogram for each class in the classified image file.

The Job Status dialog opens as the histograms are computed. This dialog automatically closes when the process is completed.

2. If desired, select **Histograms | Save** to save this histogram file.
3. In the CellArray of the Threshold dialog, move the > prompt to the **Agricultural Field\_2** class by clicking under the > column in the cell for **Class 2**.
4. Select **Histograms | View**.

The Distance Histogram for **Agricultural Field\_2** displays.

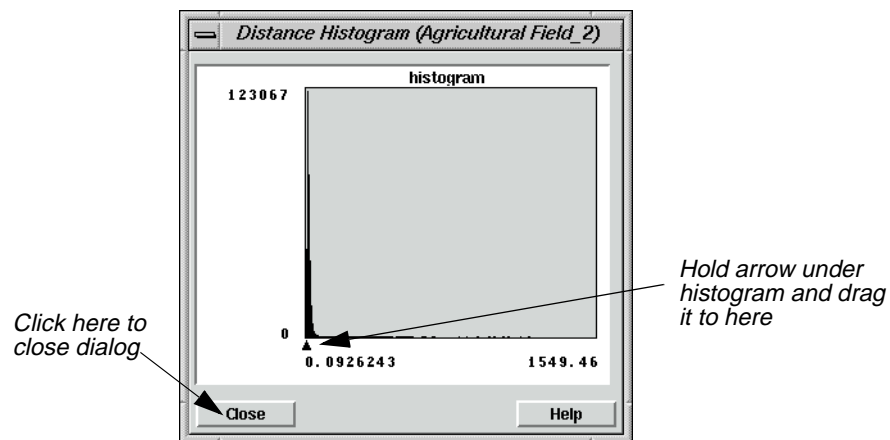

5. Select the arrow on the X axis of the histogram graph to move it to the position where you want to threshold the histogram.

The **Chi-Square** value in the Threshold dialog is updated for the current class (**Agricultural Field\_2**) as you move the arrow.

6. In the Threshold dialog CellArray, move the > prompt to the next class.

The histogram is updated for this class.

7. Repeat the steps, thresholding the histogram for each class in the Threshold dialog CellArray.



See "CHAPTER 6: Classification" of the *ERDAS Field Guide* for more information on thresholding.

8. After you have thresholded the histogram for each class, click **Close** in the Distance Histogram dialog.

### Apply Colors

1. In the Threshold dialog, select **View | View Colors | Default Colors**.

Use the default setting so that the thresholded pixels appear black and those pixels remaining appear in their classified color in the thresholded image.



## Advanced Classification

2. In the Threshold dialog, select **Process | To Viewer**.

The thresholded image is placed in the Viewer over the **germtm\_superclass.img** file. Yours likely looks different from the one pictured here.

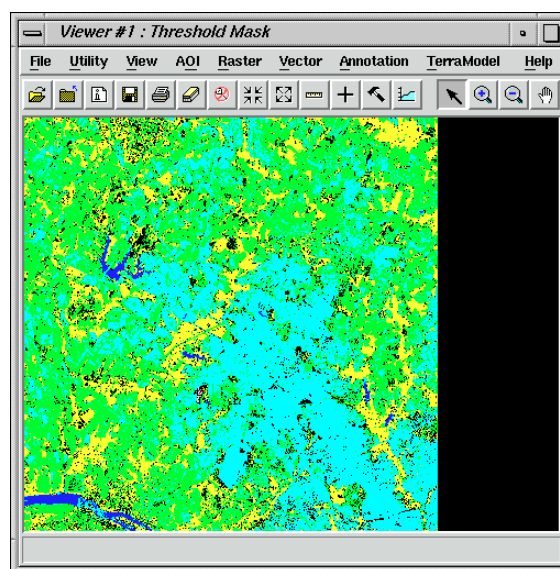

### Use the Flicker Utility

1. In the Viewer menu bar, select **Utility | Flicker** to see how the classes were thresholded.

The Viewer Flicker dialog opens.

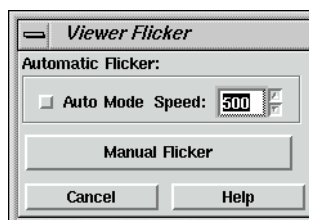

2. When you are finished observing the thresholding, click **Cancel** in the Viewer Flicker dialog.

3. In the Viewer, select **View | Arrange Layers**.

The Arrange Layers dialog opens.

4. In the Arrange Layers dialog, right-hold over the thresholded layer (**Threshold Mask**) and select **Delete Layer** from the **Layer Options** menu.

5. Click **Apply** and then **Close** in the Arrange Layers dialog. When asked if you would like to save your changes, click **No**.

6. In the Threshold dialog, select **Process | To File**.





The Threshold to File dialog opens.

### Process Threshold

1. In the Threshold to File dialog under **Output Image**, enter the name **germtm\_thresh.img** in the directory of your choice.

This is the file name for the thresholded image.

2. Click **OK** to output the thresholded image to a file.

The Threshold to File dialog closes.

3. Wait for the thresholding process to complete, and then select **File | Close** from the Threshold dialog menu bar.
4. Select **File | Clear** from the Viewer menu bar.

*NOTE: The output file that is generated by thresholding a classified image can be further analyzed and modified in various ERDAS IMAGINE utilities, including the Image Interpreter, Raster Attribute Editor, and Spatial Modeler.*

### Recode Classes

After you analyze the pixels, you may want to recode the thematic raster layer to assign a new class value number to any or all classes, creating a new thematic raster layer using the new class numbers. You can also combine classes by recoding more than one class to the same new class number. Use the **Recode** function under **Interpreter (icon) | GIS Analysis** to recode a thematic raster layer.



See "CHAPTER 11: Geographic Information Systems" of the *ERDAS Field Guide* for more information on recoding.

### Use Accuracy Assessment

The Accuracy Assessment utility allows you to compare certain pixels in your thematic raster layer to reference pixels, for which the class is known. This is an organized way of comparing your classification with ground truth data, previously tested maps, aerial photos, or other data.

In this example, you perform an accuracy assessment using the output thematic raster layer from the supervised classification (**germtm\_superclass.img**).

### Prepare

ERDAS IMAGINE must be running and you must have **germtm.img** displayed in a Viewer.

1. Click the Classifier icon in the ERDAS IMAGINE icon panel.



## Advanced Classification

The **Classification** menu displays.

*Click here to start the Accuracy Assessment Utility.*

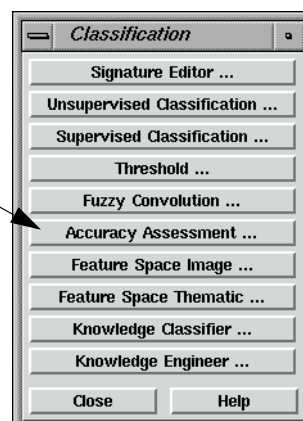

2. Select **Accuracy Assessment** from the **Classification** menu to start the Accuracy Assessment utility.

The Accuracy Assessment dialog opens.

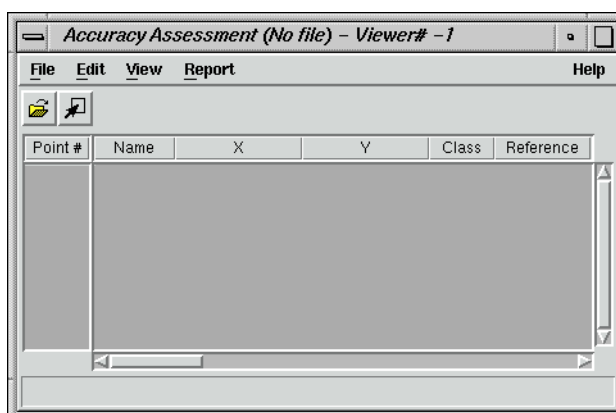

### Check the Accuracy Assessment CellArray

The Accuracy Assessment CellArray contains a list of class values for the pixels in the classified image file and the class values for the corresponding reference pixels. The class values for the reference pixels are input by you. The CellArray data reside in the classified image file (e.g., **germtm\_superclass.img**).

1. Click **Close** in the **Classification** menu to clear it from the screen.
2. In the Accuracy Assessment dialog, select **File | Open** or click the Open icon.



The Classified Image dialog opens.

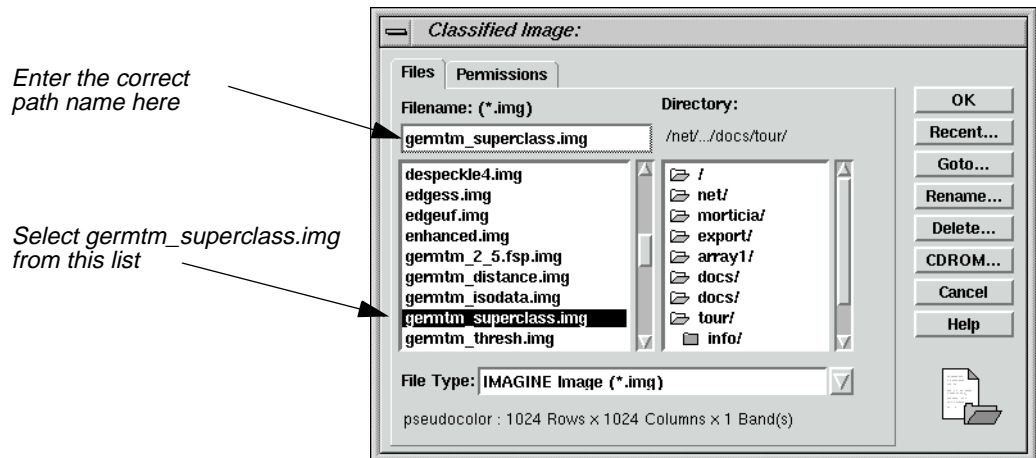

3. In the Classified Image dialog, under **Filename**, open the directory in which you previously saved **germtm\_superclass.img** by entering the directory path name in the text entry field and pressing Return on your keyboard.
4. Select the file **germtm\_superclass.img** from the list of files in the directory you just opened.  
This is the classified image file that is used in the accuracy assessment.
5. Click **OK** in the Classified Image dialog to load the file.
6. In the Accuracy Assessment dialog, select **View | Select Viewer** or click the Select Viewer icon, then click in the Viewer that is displaying the **germtm.img** file.



7. In the Accuracy Assessment dialog, select **View | Change Colors**.  
The Change colors dialog opens.

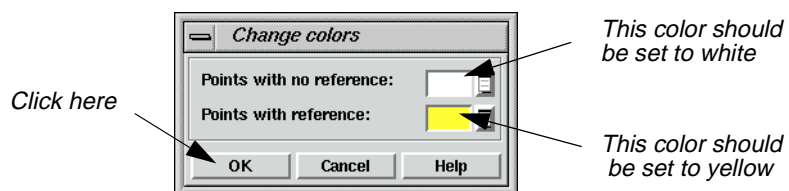

In the Change colors dialog, the **Points with no reference** color patch should be set to **White**. These are the random points that have not been assigned a reference class value.



## Advanced Classification

The **Points with reference** color patch should be set to **Yellow**. These are the random points that have been assigned a reference class value.

8. Click **OK** in the Change colors dialog to accept the default colors.

### Generate Random Points

The Add Random Points utility generates random points throughout your classified image. After the points are generated, you must enter the class values for these points, which are the reference points. These reference values are compared to the class values of the classified image.

1. In the Accuracy Assessment dialog, select **Edit | Create/Add Random Points**.

The Add Random Points dialog opens.

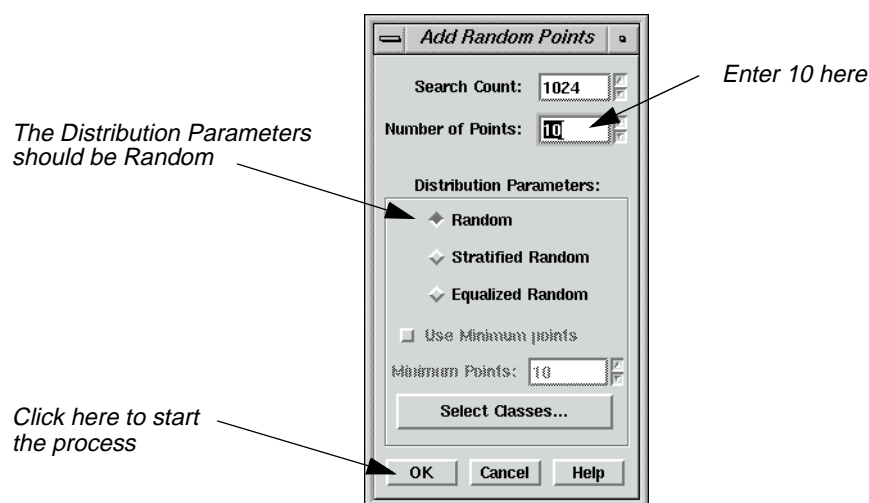

2. In the Add Random Points dialog, enter a **10** in the **Number of Points** number field and press Return on your keyboard.

In this example, you generate ten random points. However, to perform a proper accuracy assessment, you should generate 250 or more random points.

3. Confirm that the **Search Count** is set to **1024**.

This means that a maximum of 1024 points are analyzed to see if they meet the defined requirements in the Add Random Points dialog. If you are generating a large number of points and they are not collected before 1024 pixels are analyzed, then you have the option to continue searching for more random points.

*NOTE: If you are having problems generating a large number of points, you should increase the **Search Count** to a larger number.*

The **Distribution Parameters** should be set to **Random**.

4. Click **OK** to generate the random points.

The Add Random Points dialog closes and the Job Status dialog opens.

This dialog automatically closes when the process is completed. A list of the points is shown in the Accuracy Assessment CellArray.

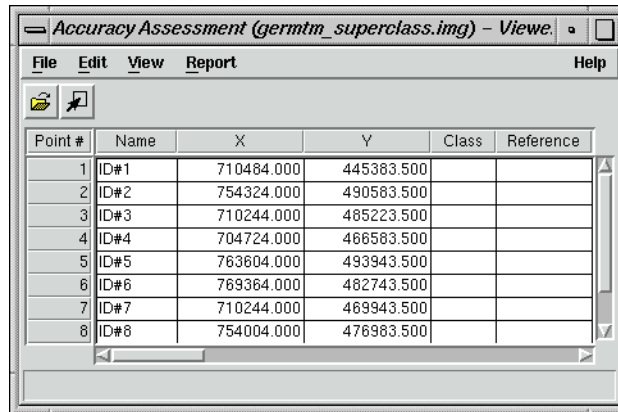

The screenshot shows a window titled "Accuracy Assessment (germtm\_superclass.img) - Viewe...". The window has a menu bar with "File", "Edit", "View", "Report", and "Help". Below the menu bar is a toolbar with icons for a folder and a magnifying glass. The main area contains a table with the following data:

Point #	Name	X	Y	Class	Reference
1	ID#1	710484.000	445383.500		
2	ID#2	754324.000	490583.500		
3	ID#3	710244.000	485223.500		
4	ID#4	704724.000	466583.500		
5	ID#5	763604.000	493943.500		
6	ID#6	769364.000	482743.500		
7	ID#7	710244.000	469943.500		
8	ID#8	754004.000	476983.500		

- In the Accuracy Assessment dialog, select **View | Show All**.

All of the random points display in the **germtm.img** file in the Viewer. These points are white.

- Analyze and evaluate the location of the reference points in the Viewer to determine their class value. In the Accuracy Assessment CellArray **Reference** column, enter your best guess of a reference relating to the perceived class value for the pixel below each reference point.

As you enter a value for a reference point, the color of the point in the Viewer changes to yellow.



---

*If you were performing a proper accuracy assessment, you would be using ground truth data, previously tested maps, aerial photos, or other data.*

- In the Accuracy Assessment dialog, select **Edit | Show Class Values**.

The class values for the reference points appear in the **Class** column of the CellArray.

- In the Accuracy Assessment dialog, select **Report | Options**. The **Error Matrix**, **Accuracy Totals**, and **Kappa Statistics** checkboxes should be turned on.

The accuracy assessment report includes all of this information.



---

*See "CHAPTER 6: Classification" of the ERDAS Field Guide for information on the error matrix, accuracy totals, and Kappa statistics.*

- In the Accuracy Assessment dialog, select **Report | Accuracy Report**.

The accuracy assessment report displays in the IMAGINE Text Editor.

- In the Accuracy Assessment dialog, select **Report | Cell Report**.



## Advanced Classification

The accuracy assessment report displays in a second ERDAS IMAGINE Text Editor. The report lists the options and windows used in selecting the random points.

11. If you like, you can save the cell report and accuracy assessment reports to text files.
12. Select **File | Close** from the menu bars of both ERDAS IMAGINE Text Editors.
13. In the Accuracy Assessment dialog, select **File | Save Table** to save the data in the CellArray.

The data are saved in the classified image file (**germtm\_superclass.img**).

14. Select **File | Close** from the Accuracy Assessment dialog menu bar.
15. If you are satisfied with the accuracy of the classification, select **File | Close** from the Viewer menu bar.

If you are not satisfied with the accuracy of the classification, you can further analyze the signatures and classes using methods discussed in this tour guide. You can also use the thematic raster layer in various ERDAS IMAGINE utilities, including the Image Interpreter, Raster Editor, and Spatial Modeler to modify the file.



---

*For more information about Classification, see "APPENDIX A: Additional Information" on page 595.*

# CHAPTER 18

## IMAGINE Expert Classifier™

---

### Introduction

This chapter is designed to introduce you to the IMAGINE Expert Classifier™. The IMAGINE Expert Classifier is composed of two modules: the Knowledge Engineer and the Knowledge Classifier. The Knowledge Engineer provides the interface for an expert with first-hand knowledge of the data and the application to identify the variables, rules, and output classes of interest and create the hierarchical decision tree. The Knowledge Classifier provides an interface for a non-expert to apply the knowledge base and create the output classification.

This set of exercises guides you through the basic process of creating a new knowledge base from scratch. The Knowledge Engineer tools and their uses are presented.

---

### Create a Knowledge Base

In this tour guide you can learn how to:

- add hypotheses
- enter rules for hypotheses
- edit variables for the rules
- copy and edit existing rules
- test a knowledge base



---

*Approximate completion time for this tour guide is 30 minutes.*

### Set Up the Output Classes

For the purpose of this exercise, suppose that you are determining Residential and Commercial Services map classes from imagery and existing mapped data. (The example classes are a subset of the **lanier.ckb** provided in the examples directory.)

This very simple two class example provides an opportunity to use and become familiar with the tools and processes of the Knowledge Engineer. The Knowledge Engineer aids in the process of designing a knowledge base by allowing you to set up a framework which can be easily be edited and rearranged during the design process.

#### Start the Knowledge Engineer

1. Click the Classifier icon and select **Knowledge Engineer** from the **Classification** menu.



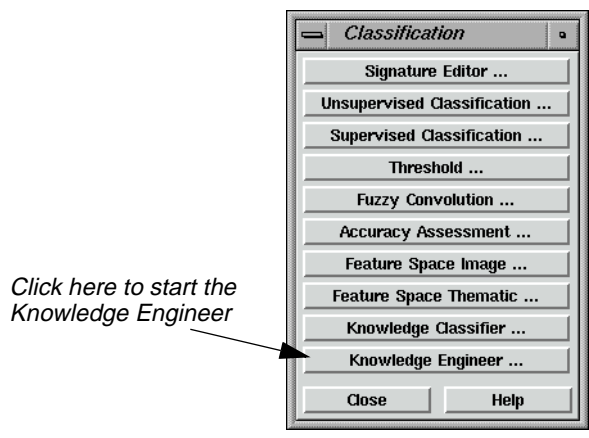

The Knowledge Engineer dialog starts with blank slates in the edit window, the decision tree overview section, and the Knowledge Base component list (**Hypotheses**, **Rules**, and **Variables**).

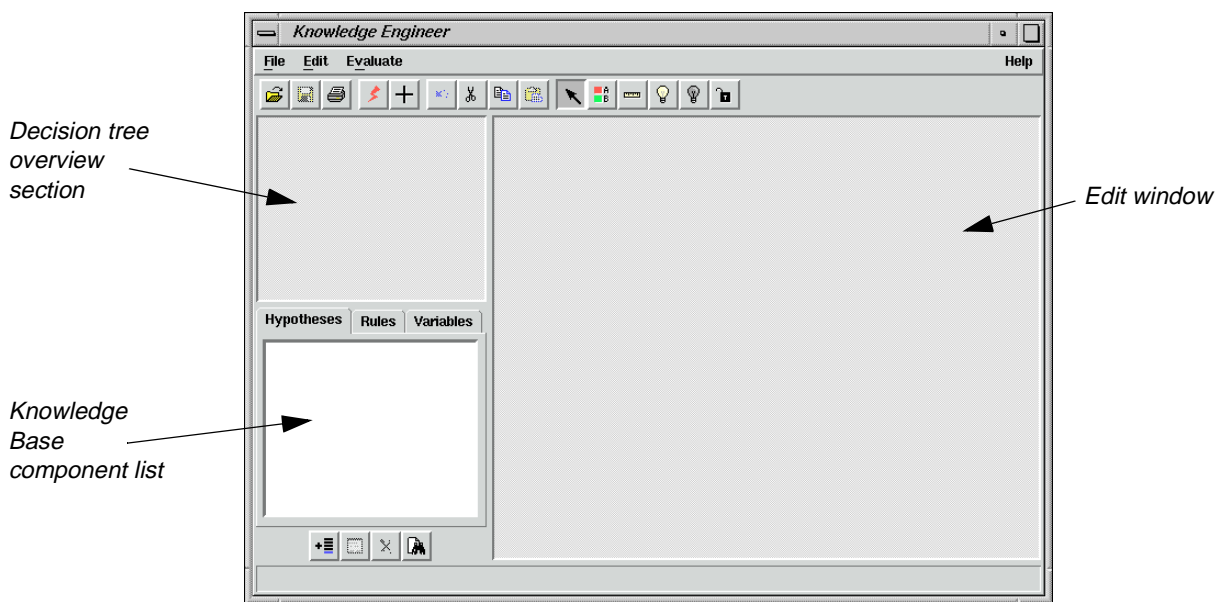

## Place Hypotheses into the Edit Window

1. Select **Edit | New Hypothesis** to add the first hypothesis.

The Hypo Props (Hypothesis Properties) dialog opens with **untitled.ckb** in the title bar, a default hypothesis name: **New Hypothesis**, and the **Color** is set to **Grayscale**.



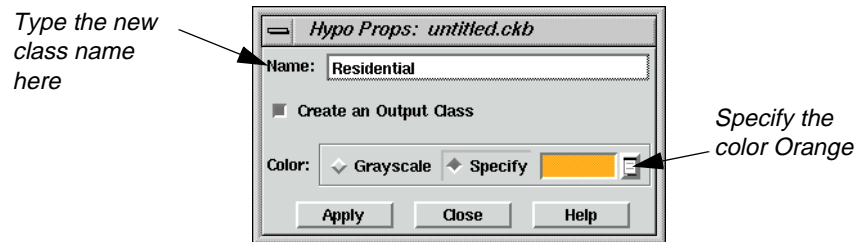

2. Change the default hypothesis **Name** to the first class name, **Residential**.
3. Since you want **Residential** to be an output class, the **Create an Output Class** checkbox is left checked.

You are going to give colors to each of the classes.

4. Click the **Specify** radio button in the **Color** section. Then use the pulldown menu to select **Orange** as the color for this class.

### Selecting Colors for Output Classes

If a color is not specified for an output class, it is automatically made grayscale. As additional grayscale output classes are added, grayscale values for each of the grayscale classes are automatically updated and stretched evenly across the range from white to black. This occurs even if some other classes are assigned specific colors.

5. Now click the **Apply** button in the Hypo Props dialog.

A green rectangle with the hypothesis name **Residential** and chip color appears in the edit window and an outline of the rectangle appears in the knowledge tree overview window. You probably noticed that there are diagonal lines through the hypothesis rectangle in the edit window. These lines remain until conditions have been added that can make the hypothesis true or false.

6. Select **Edit | New Hypothesis** once again to set up the next class, **Commercial Services**. Enter the class **Name** and **Specify Red** as the color for the class.
7. Click **Apply** in the Hypo Props dialog to add the class.
8. Click **Close** on the Hypo Props dialog.



# IMAGINE Expert Classifier™

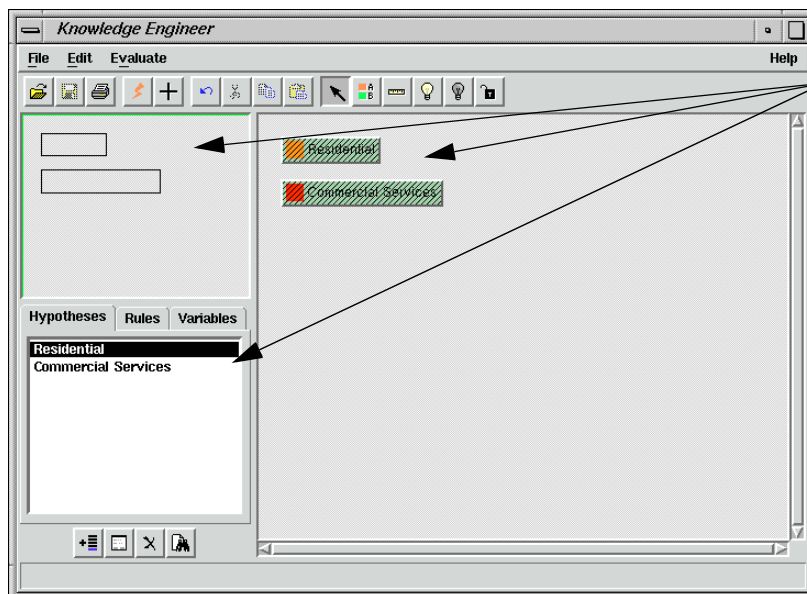

*New classes display in the edit window, in the overview, and in the component list*

## Enter Rules for the Hypothesis

1. Select the Create Rule Graphic Tool icon from the Knowledge Engineer dialog icon bar.



2. Move the cursor, which changes to the shape of a rule, and click on the green hypothesis rectangle for **Residential**.

A yellow rule rectangle, called **New Rule**, is attached to the hypothesis rectangle, **Residential**, by a line that is mirrored in the knowledge tree overview.

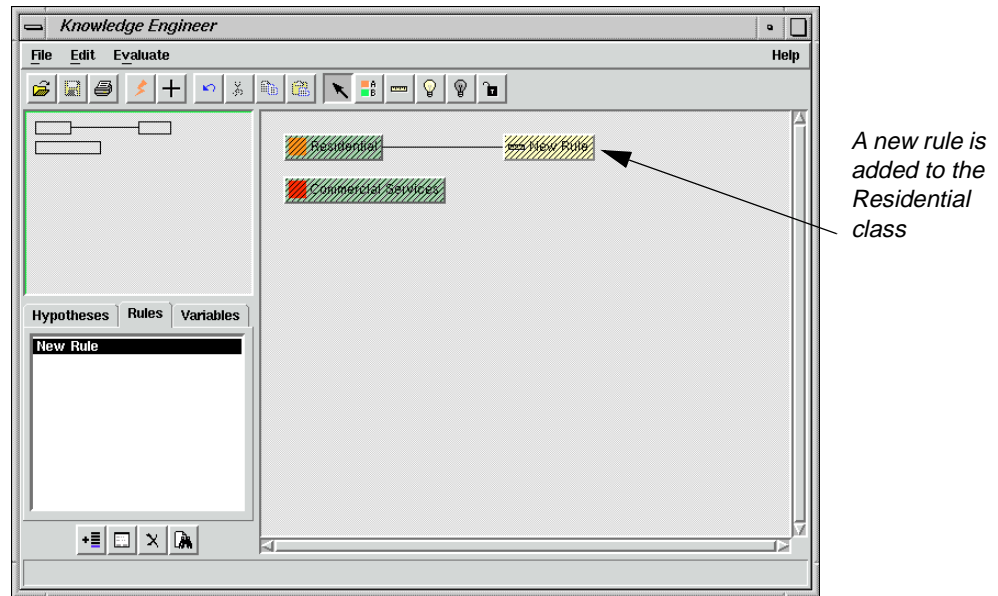

3. Double-click the yellow **New Rule** rectangle to open the Rule Props (Rule Properties) dialog.

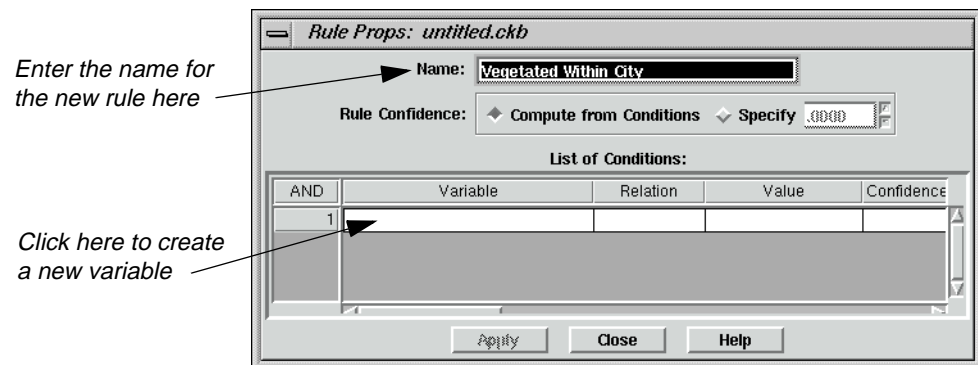

4. Change the **Name** of the rule to **Vegetated Within City** and leave the **Compute from Conditions** radio button selected for **Rule Confidence**.

### Enter Variables for the Rule

1. Click within the cell under **Variable** and select **New Variable** from the popup list.

The Variable Props dialog opens.

# IMAGINE Expert Classifier™

Type the name of the variable here

Select Raster as the Variable Type

Select Input.img here

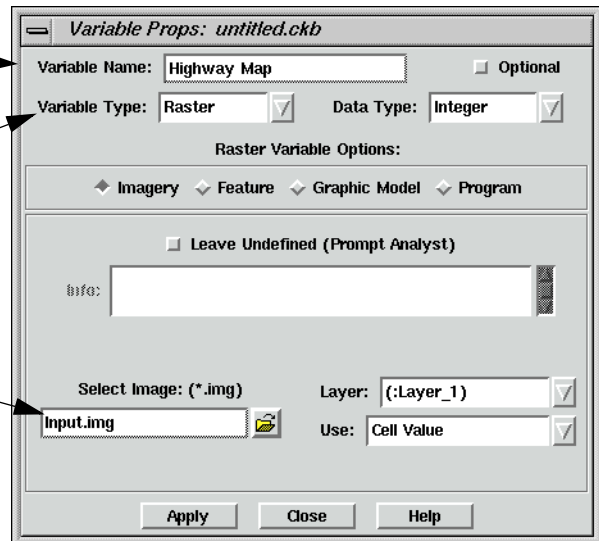

2. Change the **Variable Name** to **Highway Map**, and change the **Variable Type** to **Raster**.

Changing the type to **Raster** switches the bottom part of the dialog to the **Raster Variable Options**, providing a different set of choices than for the **Scalar** variable type.

3. Click the Select Image File icon, then navigate to and select **Input.img** from the <IMAGINE\_HOME>/examples directory.



Select Input.img

A preview displays

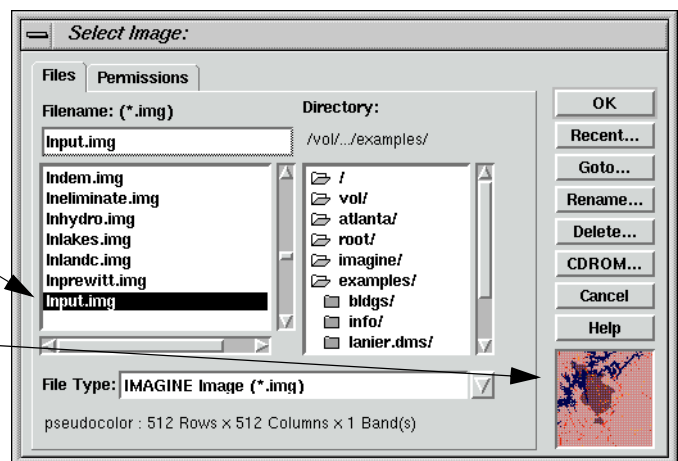

4. Click **OK** in the Select Image dialog to add the file to the Variable Props dialog.
5. Click the **Apply** button in the Variable Properties dialog to add **Highway Map** to the rule properties CellArray.

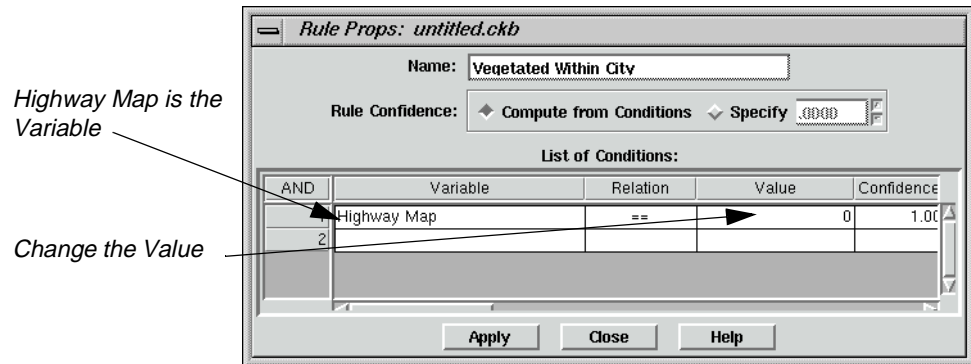

6. Click **Close** to dismiss the Variable Props dialog.
7. In the Rule Props dialog, click in the cell under **Value** and select **Other**.
8. Into the highlighted cell, type **7** and press Return on your keyboard (7 is the class number for urban areas in **Input.img**).

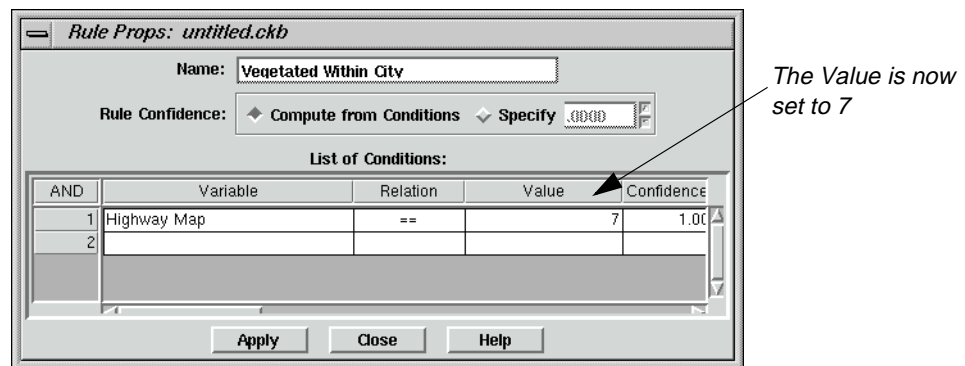

9. Click **Apply** in the Rule Props dialog to enter the changes, then **Close**.

The new rule with its attached variable appears in the edit window. Notice that the diagonal lines in the hypothesis, **Residential**, and rule, **Vegetated Within City**, rectangles have disappeared for the hypothesis and rule you have edited. This is because at least one complete condition is now set.



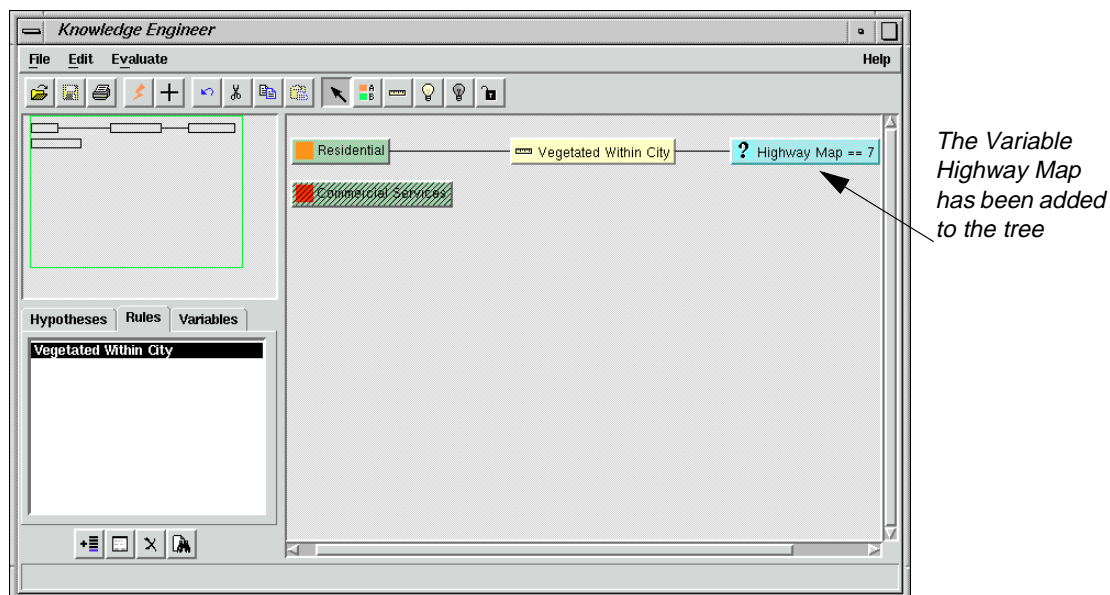

## Add an Intermediate Hypothesis

In this section, you add an intermediate hypothesis as well as its conditions.

1. Select the Create Hypothesis graphic tool and click on the rule, **Vegetated Within City**.



An intermediate hypothesis, **New Hypothesis**, is attached to the rule, linked by a **New Hypothesis == TRUE** variable.

2. Double-click the **New Hypothesis** rectangle to open the Hypo Props dialog.
3. In the Hypo Props dialog, change the name to **Vegetation** and deselect the **Create an Output Class** checkbox since you do not want this to be an output class.
4. Click **Apply**, then **Close**.

## Create a New Rule

1. Using the Create Rule graphic tool, place a **New Rule** on the **Vegetation** hypothesis.



2. Double-click on the **New Rule** to open the Rule Props dialog, and change the rule **Name** to **High IR and Low Visible**.

3. Click in the cell below **Variable** and select **New Variable**.
4. Type the name **TM Band 4** in the **Variable Name** field.
5. Change the **Variable Type** to **Raster**
6. Click the Open icon to open the Select Image dialog, and select **lanier.img** from the <IMAGINE\_HOME>/examples directory.

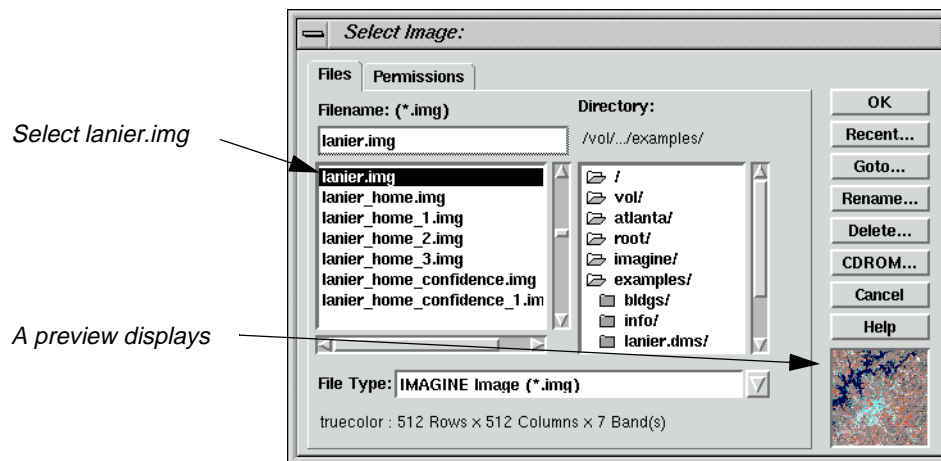

7. Click **OK** in the Select Image dialog to add **lanier.img** to the Variable Props dialog.
8. Click the **Layer** dropdown list and select **(:Layer\_4)**.
9. Click **Apply**, then **Close** in the Variable Props dialog.

The Rule Props dialog updates.

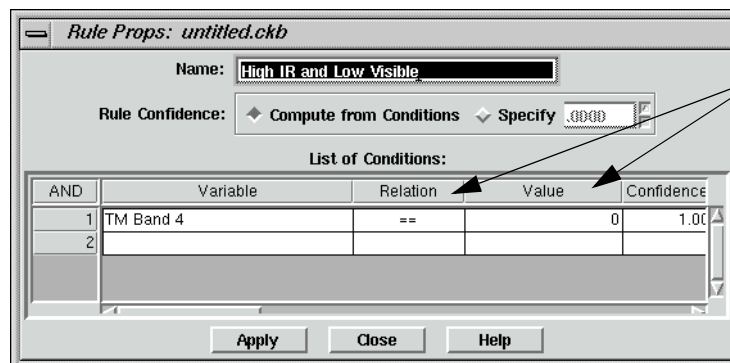

Now that you have created the Variable, change its Relation and Value

10. In the Rule Props dialog, click in the cell below **Relation** and select **>=**.
11. Click, then select **Other** from the **Value** cell, change the **Value** to **21**, then press Return on your keyboard.
12. Now, using step 3. through step 11. above, add layer 2 of **lanier.img** as the second variable (row **2** under the **AND** column), name it **TM Band 2**, set **Relation** to **<** and set the value to **35**.

Two Variables, their Relations and Values have been added to the rule High IR and Low Visible

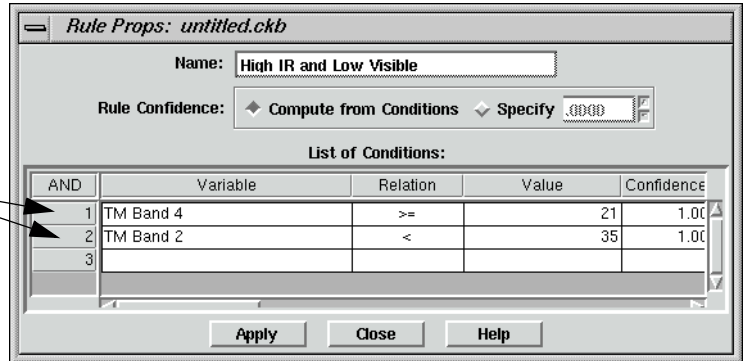

- Click **Apply**, then **Close** in the Rule Props dialog.

## Copy and Edit

Since the hypothesis for the **Commercial Services** class has very similar rules and conditions to the **Residential** class, some of the conditions can be used directly, or copied and edited to save time.

- Begin editing the **Commercial Services** class by placing a new rule on the **Commercial Services** hypothesis rectangle, then double-clicking the **New Rule** to open the Rule Props dialog.



Refer to "Enter Rules for the Hypothesis" on page 506 if you forget how to create a new rule.

- In the Rule Props dialog, change the **Name** of the rule to **Bright Within City**.

The first variable that is needed is **Highway Map**, which is now in the **Variable** list since it was entered previously.

- Click in the cell below **Variable** and select **Highway Map**, confirm that the **Relation** is set to **==**, and set the **Value** to **7**.

As before, this makes the variable equal to the urban area from **Input.img**.

The Commercial Services class has the rule Bright Within City, which has the Variable Highway Map.

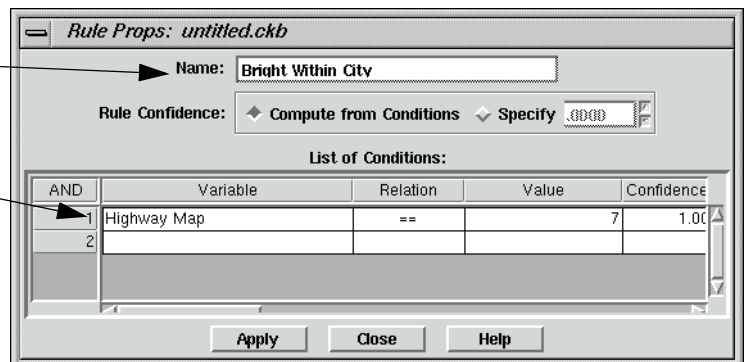

- Click **Apply** in the Rule Props dialog, then **Close**.



- Now use the Create Hypothesis graphic tool to place a new hypothesis (which is an intermediate hypothesis) on the **Bright Within City** rule rectangle.



See "Add an Intermediate Hypothesis" on page 510 if you forgot how to create a hypothesis.

- Double-click on the **New Hypothesis** to open the Hypo Props dialog.
- In the Hypo Props dialog, name the new hypothesis **Bright** and deselect the **Create an Output Class** checkbox.
- Click **Apply**, then **Close** in the Hypo Props dialog.

The Knowledge Engineer dialog updates accordingly.

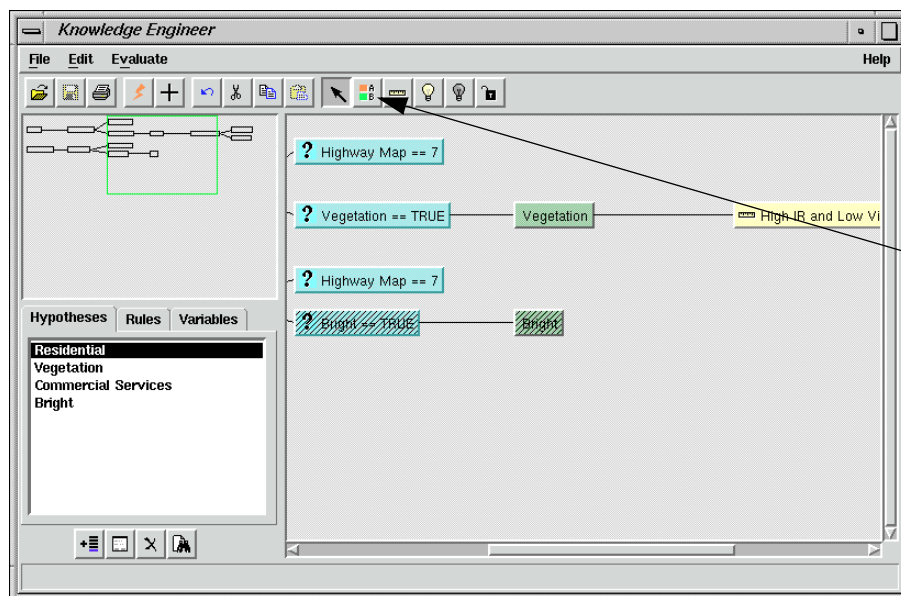

Since the rule to be attached to the **Bright** hypothesis is very similar to the **High IR and Low Visible** rule that is attached to the **Vegetation** hypothesis, you can make a copy of it to paste and edit.

- Click on the **High IR and Low Visible** rule.
- Right-click, and select **Copy** from the **Options** menu.
- Click on the **Bright** hypothesis, then right-click and select **Paste** from the **Options** menu.

A new rule is attached to the **Bright** hypothesis with a default name of **High IR and Low Visible (1)** (the **(1)** is added since it is a copy).

- Double-click the **High IR and Low Visible (1)** rule to open the Rule Props dialog.
- In Rule Props dialog for the new rule, change the **Name** to **High IR and High Visible**.



# IMAGINE Expert Classifier™

The only change that needs to be made to the variables is the **Relation** for **TM Band 2**.

14. Change the **Relation** for **TM Band 2** to **>=**.
15. Click **Apply**, then **Close** in the Rule Props dialog.

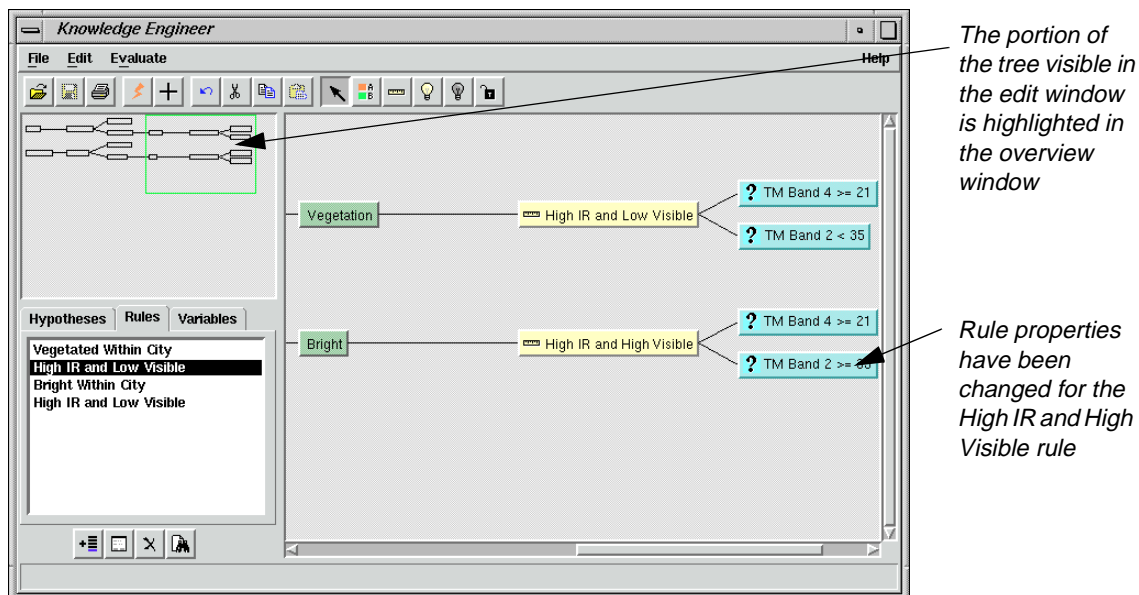

At this point, two hypotheses and their conditions have been entered. Now, the two classes can be tested to see what pixels are allocated to them.

## Test the Knowledge Base

1. On the Knowledge Engineer dialog tool bar, select the Run Test Classification icon (or select **Evaluate | Test Knowledge Base**).



The Knowledge Classification dialog opens in Test Mode at the **SELECT THE CLASSES OF INTEREST** panel, along with a new Viewer where the test classification is displayed. All active enabled classes are selected by default.

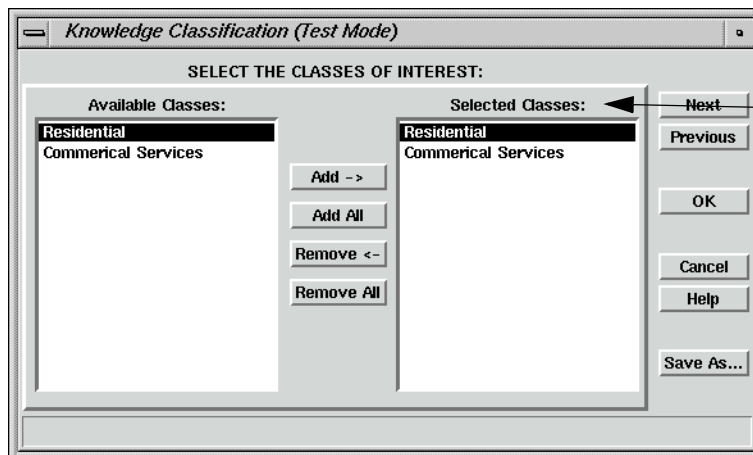

The Selected Classes are Residential and Commercial Services

2. Leave the two classes, **Residential** and **Commercial Services**, selected in the **Selected Classes** section of the Knowledge Classification dialog.
3. Click **Next** to go to the next panel of the Knowledge Classification dialog.



If the **Prompt User** option had been selected instead of entering file names for the variables, an intermediate panel, **SELECT THE INPUT DATA FOR CLASSIFICATION**, would appear here to allow entry of file names.

The **Select Classification Output Options** panel allows you to set the number of best classes per pixel, set an output area and set an output cell size. The defaults are used here since you only have two classes and small images that are the same size and have the same cell size.

Also note the grayed-out options for **Output Classified Image**, **Output Confidence Image**, and **Output Feedback Image**. These images are made temporary files in **Test Mode**, but can be selected as output files when running **Knowledge Classifier** in regular (non-test) mode from the **Classification** menu.



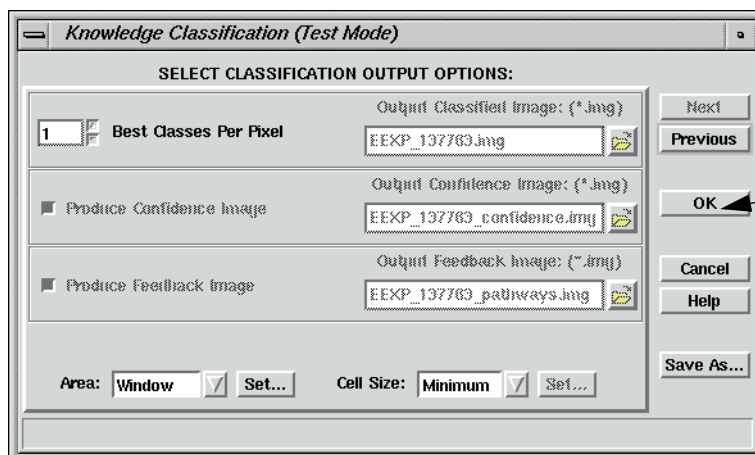

4. Click **OK** in the Knowledge Classification dialog to start the test classification.

A status bar opens. When the classification has completed, the test classification image is displayed in the Viewer.

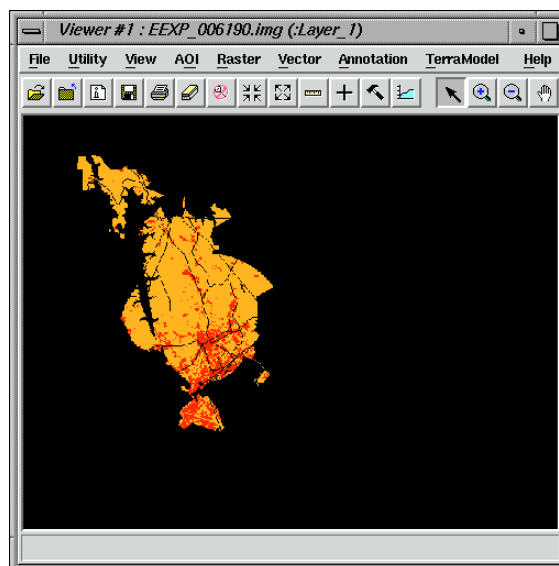

5. Click **OK** to dismiss the status bar when the classification is finished.
6. In the Knowledge Engineer dialog, click on the Start Classification Pathway Feedback Mode icon.



The Classification Path Information dialog is opened along with a cursor in the Viewer.

Details about the class under the cursor display here

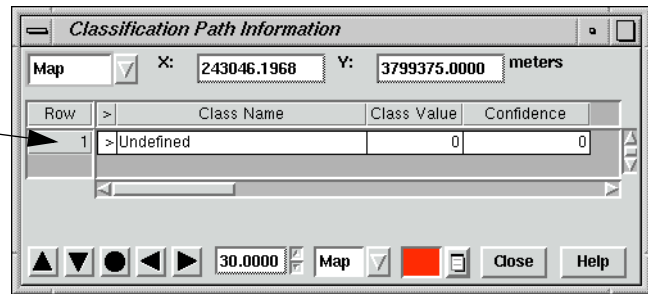

7. Move the cursor into the orange and red areas in the Viewer, which correspond to the orange **Residential** class and the red **Commercial Services** class.

Note that when the cursor is placed on a pixel for one of the classes, the path for the class is highlighted in the Knowledge Engineer dialog and in the overview window. In complex knowledge bases, this feature is useful for telling at a glance which hypothesis was used to classify the point of interest.

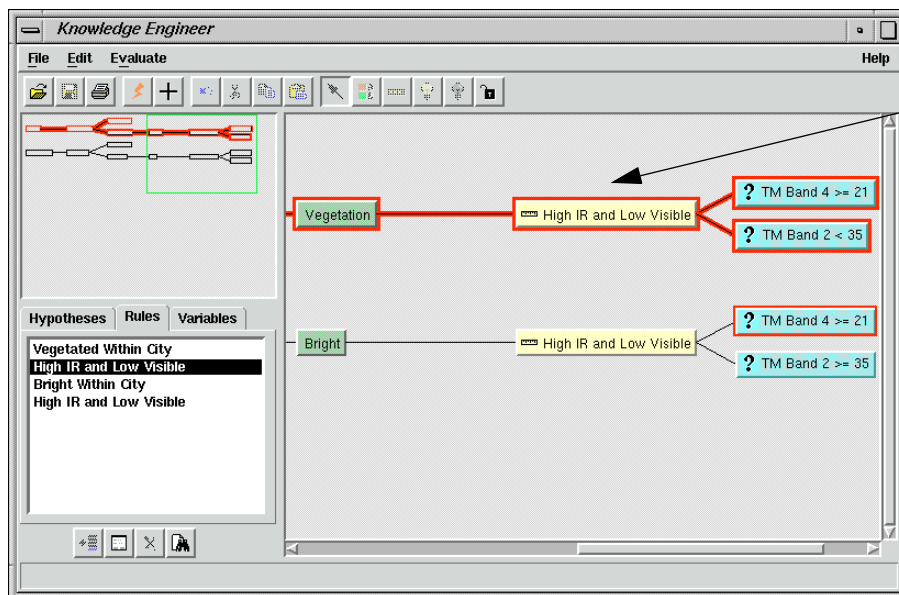

8. Click the **Close** button to dismiss the Classification Path Information dialog.
9. Select the gray Disable Node icon, then click on the **Commercial Services** hypothesis graphic to disable it.



The Commercial hypothesis path is grayed-out. This means the class is not considered when a test classification is run (or, in the regular Knowledge Classifier, if the knowledge base has been saved with the class disabled).

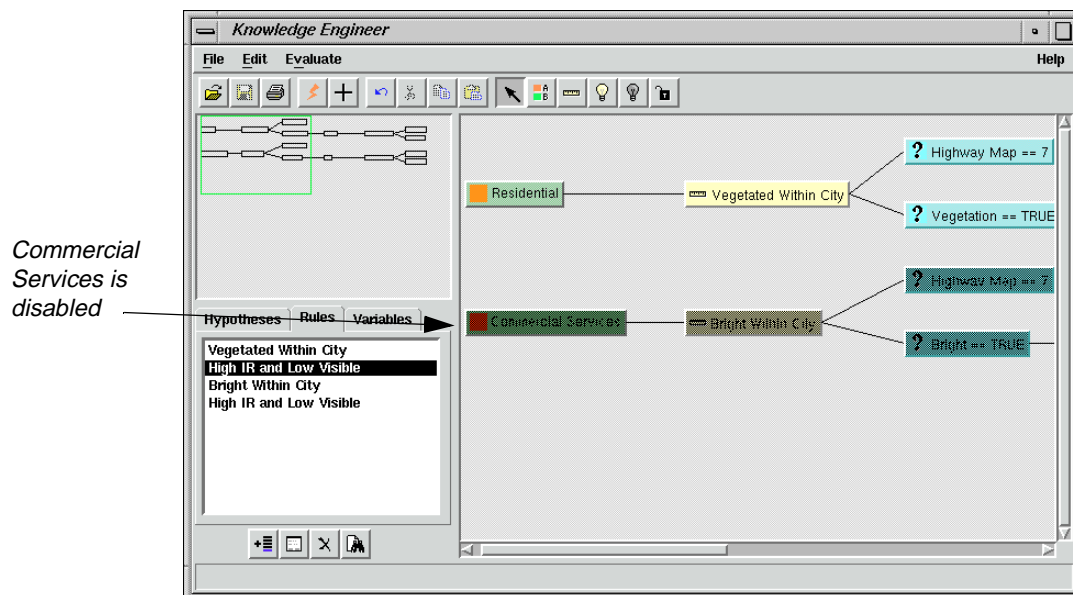

10. To enable the **Commercial Services** class once again, click on the **Commercial Services** hypothesis graphic with the yellow Enable Node icon (or right-click on the hypothesis graphic and select **Enable**).



11. Save the knowledge base by selecting **File | Save As**.
12. Navigate to a directory in which you have write permission, and name the file **ResComm\_Class.ckb**.
13. Click **OK** in the Save Classification Knowledge Base As dialog.
14. Select **File | Close** from the Knowledge Engineer dialog, which is now entitled **ResComm\_Class.ckb**, to finish.

---

### Create a Portable Knowledge Base

This exercise is going to give you practice creating and using a portable knowledge base. In this example, you use a knowledge base to determine areas most suitable for cross-country travel.

#### Data

Data available for the project includes the following:

- a landcover classification (**supervised.img**)
- a DEM (**30meter.img**)
- a map of minor and major roads (**roads.img**)
- a near-infrared degraded air photo with 30m resolution (**mason\_ap.img**)

The file **supervised.img** shows a typical landcover classification derived from Landsat TM data (a portion of the Landsat scene is provided as **tm\_860516.img** along with the signature file **tm\_860516.sig**, which was used to produce a maximum likelihood classification). The image shows the distribution of broad landcover categories such as different types of forestry, human-made features, water and open ground. However, it does not show the land use of each pixel, or how each pixel could be put to use.

Consider a scenario whereby someone wishes to traverse this area of ground with one or more vehicles. They need to use the landcover information, along with other ancillary data to help determine which areas can be traversed easily and which cannot.

#### Methodology

Given these data sets, we can start to envisage expert rules that are based on these data (and data derived from them) to determine the ease of crossing a particular area.

#### Prepare

ERDAS IMAGINE must be running.

1. Click the Classifier icon in the ERDAS IMAGINE icon panel.

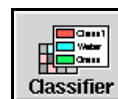

The **Classification** menu opens.



# IMAGINE Expert Classifier™

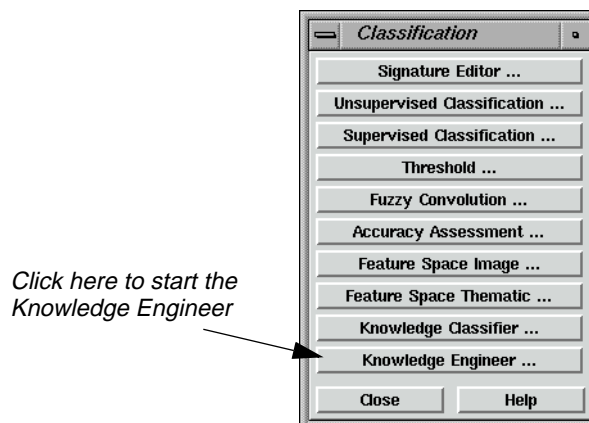

2. Click **Knowledge Engineer** in the **Classification** menu.

An empty Knowledge Engineer dialog opens.

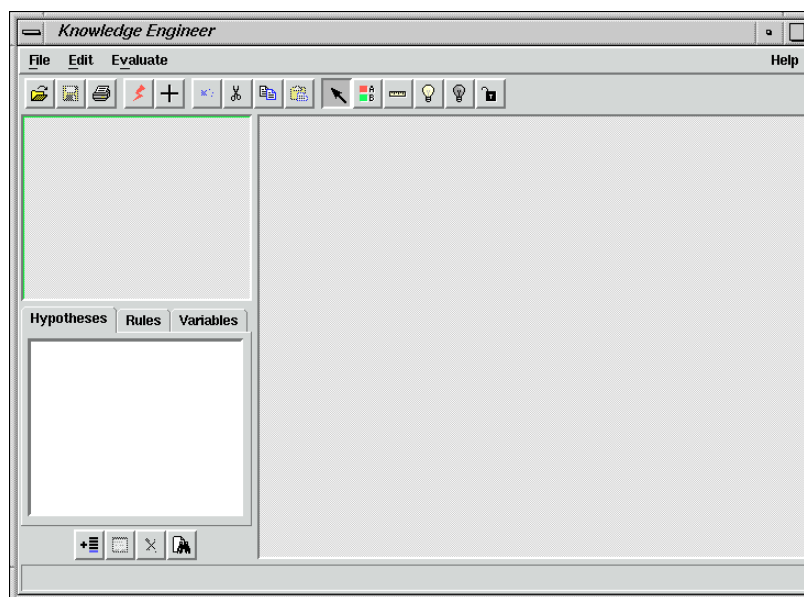

## Open a Knowledge Base

Next, you can open the **mobility\_factors.ckb** knowledge base to examine what expert rules are used and how their components were created.

1. In the Knowledge Engineer dialog, click the Open icon, or select **File | Open**.



The Open Classification Knowledge Base dialog opens.

2. Navigate to the <IMAGINE\_HOME>/examples directory, and select the file **mobility\_factors.ckb**.





<IMAGINE\_HOME> is the directory where ERDAS IMAGINE resides on your system.

- Click **OK** in the Open Classification Knowledge Base dialog to load the file.

The knowledge base of mobility factors opens.

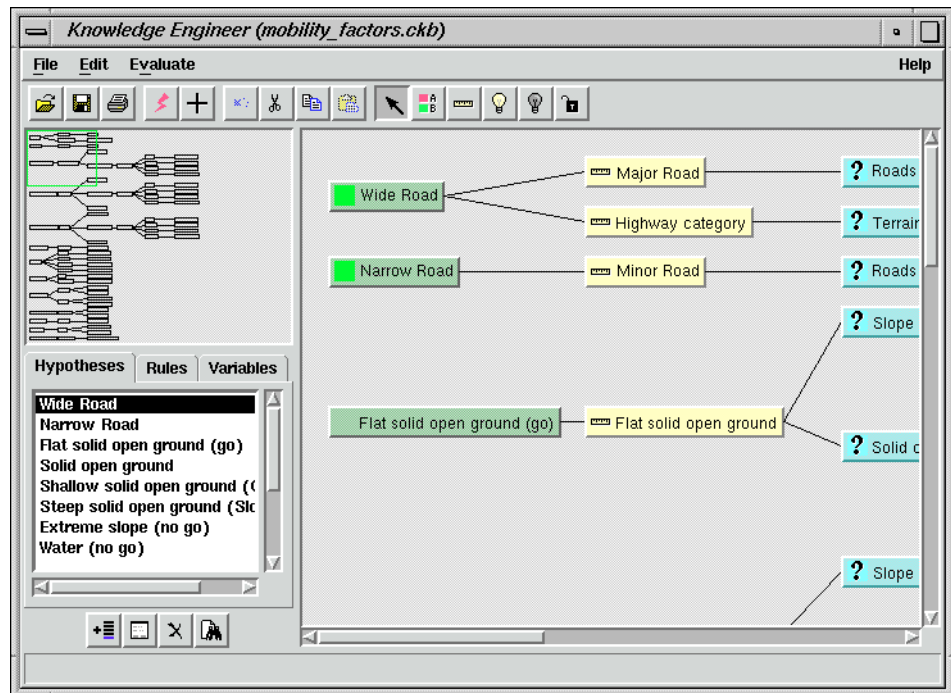

## Examine the Knowledge Base

This knowledge base was created by defining as many of the variables as would be needed as possible. For example, roads are going to be the easiest areas to traverse, so a variable was needed to define where roads are that can be used.

- In the Knowledge Engineer dialog, click on the **Variables** tab.

The variables for the **mobility\_factors.ckb** knowledge base display.

Double-click the Roads variable to see its properties

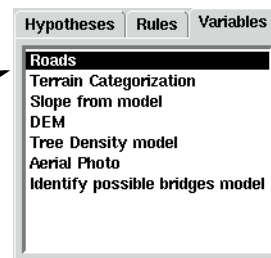

- In the **Variables** list, double-click the **Roads** variable.

The Variable Props dialog opens.



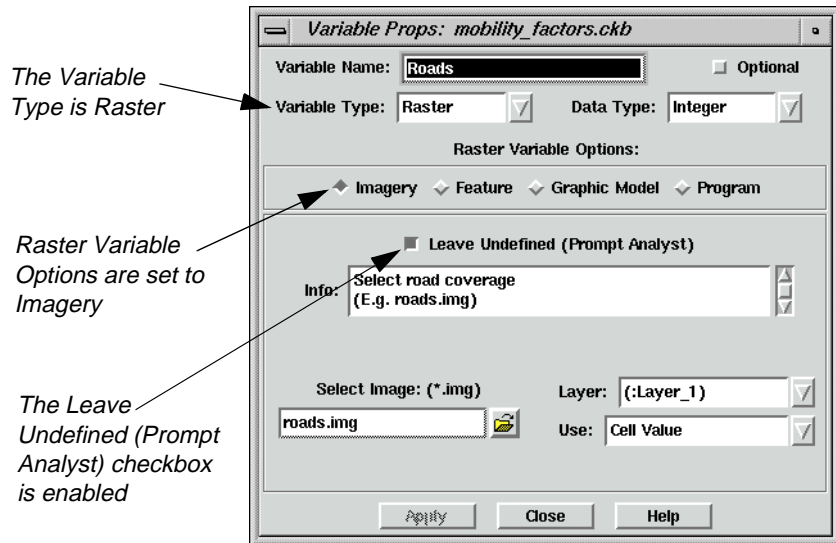

In the Variable Properties dialog, you can see that the **Variable Type** is **Raster** and the **Imagery** option is selected because the input is an image.

This knowledge base is transportable—you may want to pass it to a colleague in another office, or reuse it yourself to automate a production process. So, rather than selecting a specific image to be used, the **Leave Undefined** checkbox is selected and a prompt for the type of data that you want the end user to supply is typed in the **Info** window (i.e., **Select road coverage**).

The same type of imagery variables have been defined for the landcover classification (**Terrain Categorization**), Digital Elevation Model (**DEM**) and air photo (**Aerial Photo**).

Some of the imagery variables are used directly in rules (such as the **Terrain Categorization** variable being used to identify open ground in the image). Others are used indirectly to calculate variable values.

For example, open ground (e.g., grass, scrub) is also good for vehicles to cross, but not if the ground is steeply sloping. The fact that an area is open ground can be determined from the landcover classification (the **Terrain Categorization** variable), but you do not have an image that provides slope directly. However, you do have a digital elevation model (the **DEM** variable), which can be used to derive slope.

## Derive Slope Values

1. In the **Variables** tab, double-click the variable called **Slope from model**.

The Variable Props dialog updates accordingly.

## Create a Portable Knowledge Base

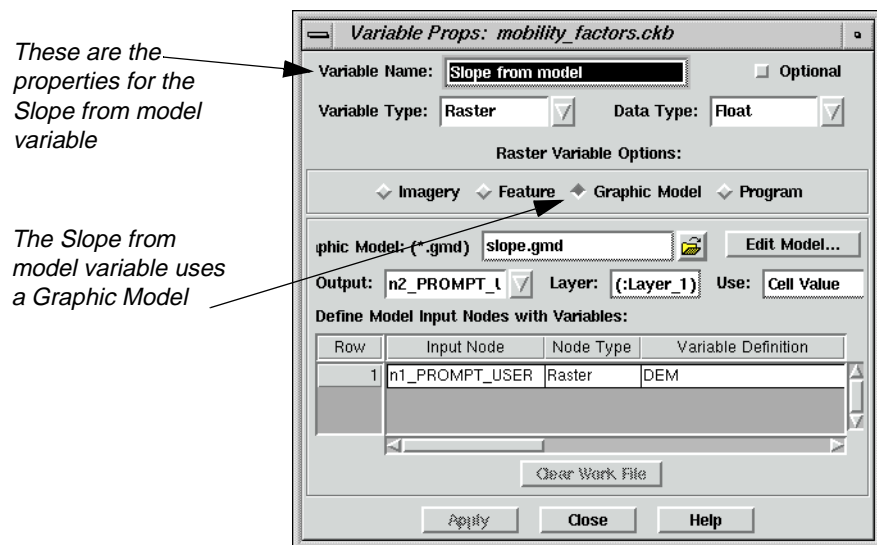

Notice that the variable is again raster in nature, so the **Variable Type** is set to **Raster**. In this case, however the **Graphic Model** option of the **Raster Variable Options** has been selected. The graphic model associated with this variable is named **slope.gmd**.

2. In the Variable Props dialog, click on the **Edit Model** button to view the graphic model.

A Spatial Modeler viewer opens, which contains the model that defines the **Slope from model** variable.



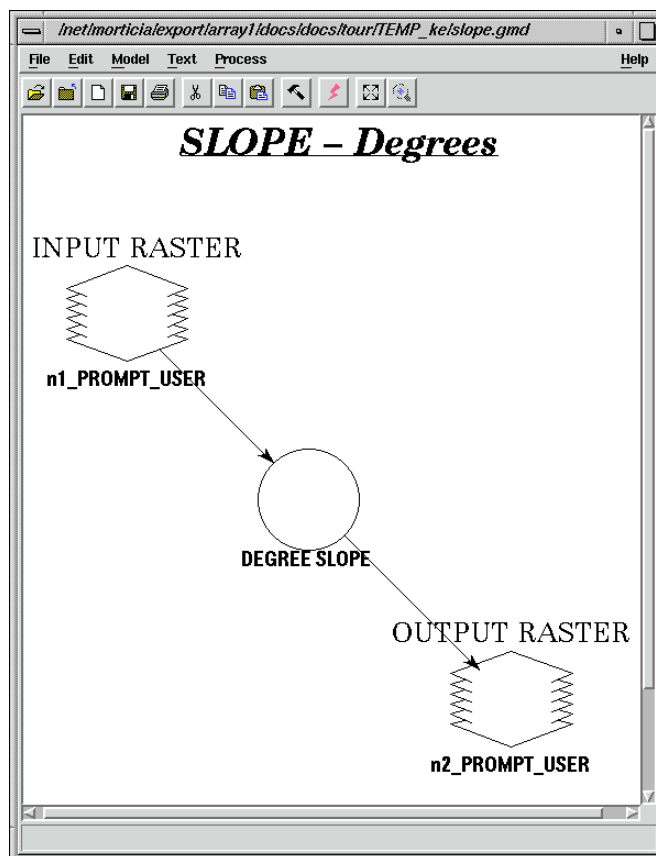

This is the model that the variable **Slope from model** uses to calculate the slope of any location.

To make the knowledge base transportable, you do not want to define actual image names in the **slope.gmd** model. Instead, the **INPUT RASTER** and the **OUTPUT RASTER** of the model have been set to **PROMPT\_USER**.

In the Variable Properties dialog, the **PROMPT\_USER Input Node** that was the output in the model has been defined as the **Output**, and the following CellArray has been used to define which variables should be used to supply which **Input Node**. In this instance, clicking in the **Variable Definition** cell gave the list of defined variables from which **DEM** was selected.

## Create a Portable Knowledge Base

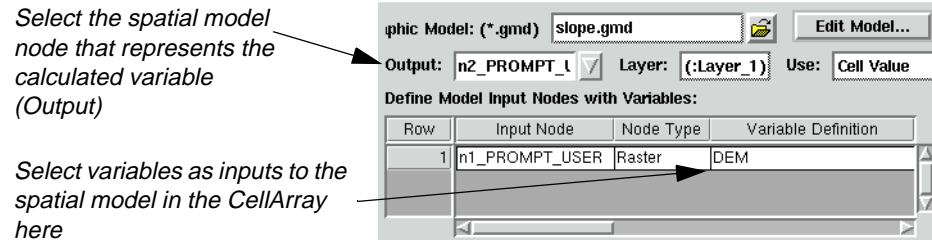

Thus, a variable has been defined that calculates values on the fly as needed from another variable (in this case, slope is derived from a DEM).

3. Click the Close Model icon, or select **File | Close** from the Spatial Modeler viewer.



The Spatial Modeler viewer closes.

4. Click **Close** in the Variable Props dialog.

### Build Hypotheses

Since you have looked at how the two main types of input variable can be defined, now you can look at how each hypothesis is built in the knowledge base.

The knowledge base **mobility\_factors.ckb** displays:



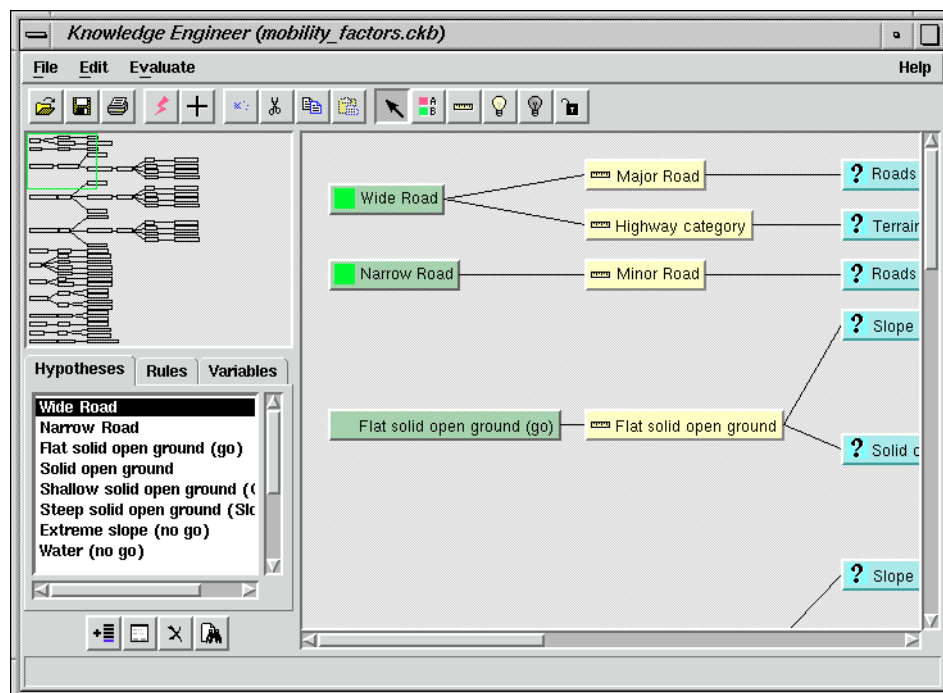

The first two hypotheses, **Wide Road** and **Narrow Road**, are fairly simple. The expert rule in these cases is that something identified as a road is going to be easily traversable by the vehicles, with major roads being better than minor roads.

Consequently, the **Wide Road** hypothesis has two rules (i.e., they each have an **OR** statement so that either needs to be true for the hypothesis to be true). The first looks for major roads (DN value 2) in the **Roads** variable (roads.img), and the second looks for pixels that are potentially identified as roads by the supervised classification.

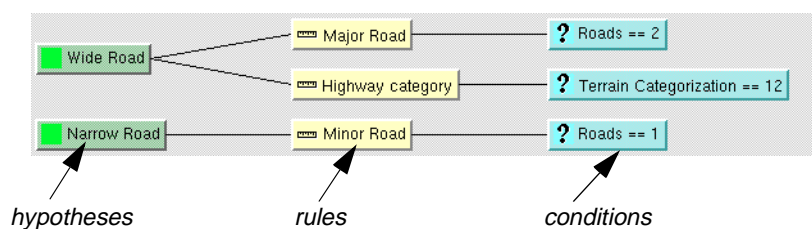

1. Double-click on the **Highway category** rule.

The Rule Props dialog opens.

## Create a Portable Knowledge Base

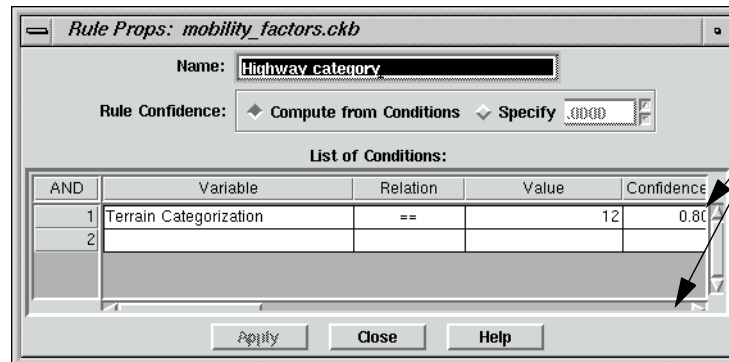

The Rule Props dialog shows how this particular rule depends on the **Terrain Categorization (supervised.img)** file.

2. In the Rule Props dialog, click the horizontal scroll bar until you can see the **Confidence** value, **0.80**.
3. In the Knowledge Engineer dialog, click on the **Major Road** rule.  
Its properties display in the Rule Props dialog.
4. Click the horizontal scroll bar until you can see the **Confidence** value, **0.98**.

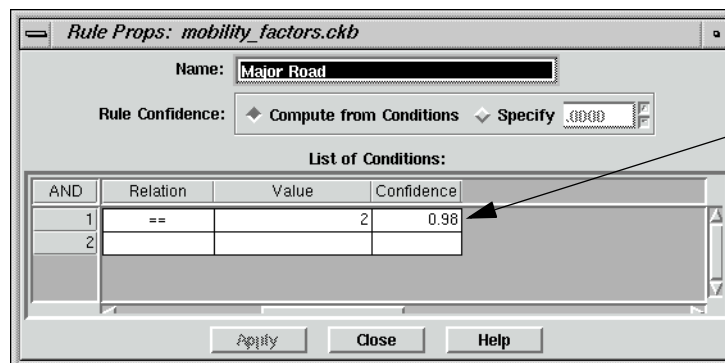

Note that the **Confidence** field for the **Highway category** rule has been set to a much lower value than the **Confidence** for the **Major Road** rule. This is because you are less certain of the results from a maximum likelihood classification than you would be from a road map.

The next four hypotheses work on the same basis. The expert rule is that open ground types are good for vehicle passage. As slopes get steeper, however, the open ground becomes less and less manageable until it becomes impassable at very steep angles.

5. Click **Close** in the Rule Props dialog.

### Set ANDing Criteria

These hypotheses also demonstrate the **ANDing** of criteria in a rule. The **Flat solid open ground (go)** hypothesis has only one rule, but that rule has two conditions. Both conditions must be true for a rule to be true.



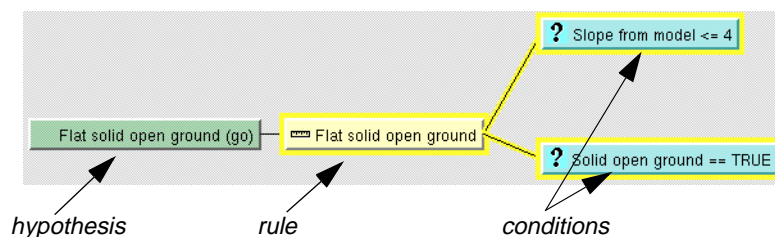

1. Double-click the **Slope from model <= 4** condition.

The Rule Props dialog opens.

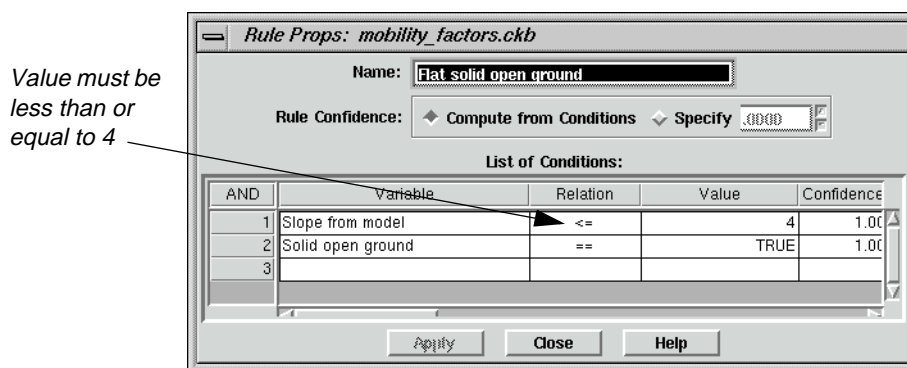

In the **List of Conditions** CellArray, the slope calculated by the **Slope from model** variable must be less than or equal to **4** degrees, and (i.e., **AND**, note the far left column of the CellArray) the **Solid open ground** variable must be true before this rule can be true.

2. Click **Close** in the Rule Props dialog.

The rule **Flat solid open ground** is defined by an intermediate hypothesis: **Solid open ground**.

3. In the Knowledge Engineer dialog, click the horizontal scroll bar and move it to the right until you can see the intermediate hypothesis **Solid open ground**.



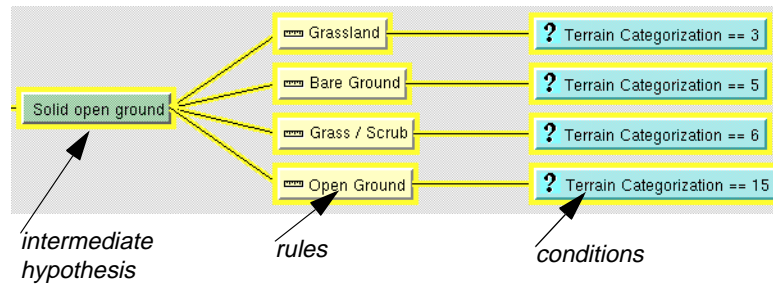

The intermediate hypothesis **Solid open ground** uses the **Terrain Categorization** variable to identify various types of open ground cover.

**Check Other Hypotheses** You can check the other hypotheses listed along the left side of the Knowledge Engineer dialog.

1. Position the horizontal scroll bar to the extreme left in the Knowledge Engineer dialog.
2. Move the vertical scroll bar down until you see the **Water (no go)** hypothesis.

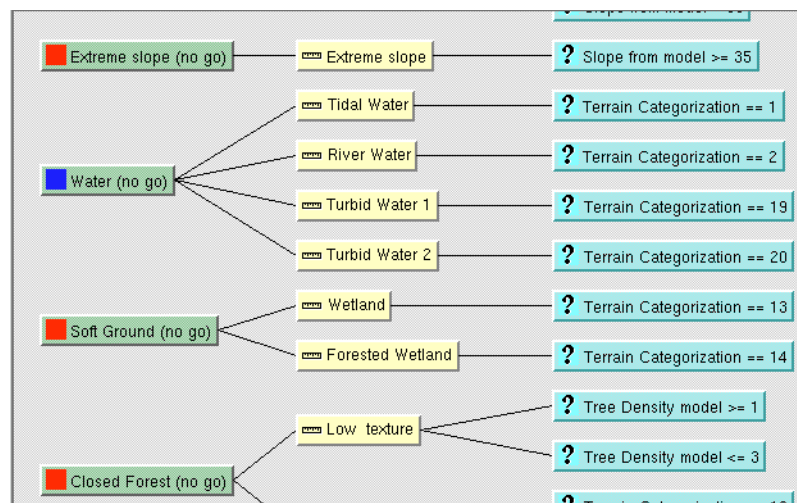

The **Water (no go)** hypothesis is a simple expert rule that states that if the **Terrain Categorization** variable shows that a location is water, it is impassable.

3. Note the hypothesis below **Water (no go)**: **Soft Ground (no go)**.

Similarly, the **Soft Ground (no go)** hypothesis is a simple expert rule that states that if the **Terrain Categorization** variable shows that a location is a type of wetland, it is impassable.

### Introduce Spatial Logic to the Knowledge Base

The three forest hypotheses are more complicated, and show how spatial operators can be used within the IMAGINE Expert Classifier to create a spatially aware classifier (rather than a traditional per-pixel classifier).

1. Use the vertical scroll bar to scroll down to the various forest hypotheses.



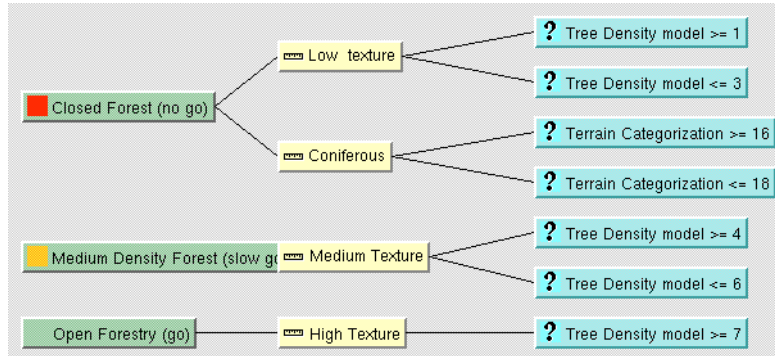

The expert rule is that open forest canopies are easier to traverse than closed forest canopies because space between trunks is not as large with a closed canopy (i.e., trees are older and have large trunks). However, it is difficult to determine canopy closure on a per-pixel basis.

To a certain degree, canopy closure can be inferred from the type of tree cover. For instance, if the cover is coniferous, then it is more likely that you have a close canopy and close trunks. However, this is more difficult to state for mixed and other types of tree cover.

Consequently, this particular hypothesis also looks at panchromatic aerial photography to try and determine crown closure. However, you cannot determine crown state on a per-pixel basis. Instead, the **Tree Density model** variable (using the **Aerial Photo** and **Terrain Categorization** variables as inputs) executes a graphical model (**texture.gmd**).

2. Click the **Variables** tab in the Knowledge Engineer dialog.

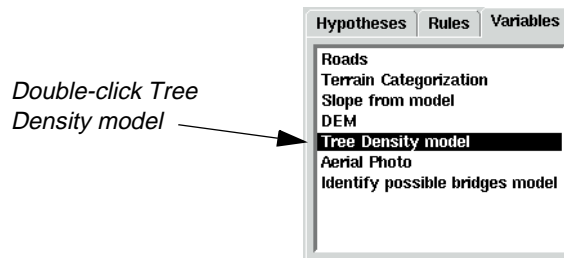

3. Double-click to select the **Tree Density model** variable.

The Variable Props dialog for the **Tree Density model** variable opens:

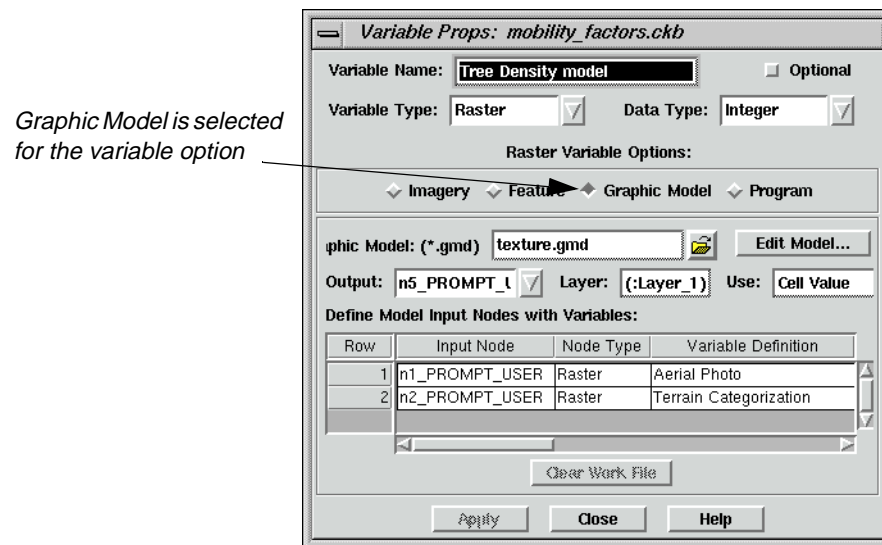

4. Note that the **Raster Variable Options** for the **Tree Density model** variable is set to **Graphic Model**.

The model that provides information for the **Tree Density model** variable is **texture.gmd**.

5. Click the **Edit Model** button in the Variable Props dialog.

The Spatial Modeler viewer opens, which displays the model **texture.gmd**.



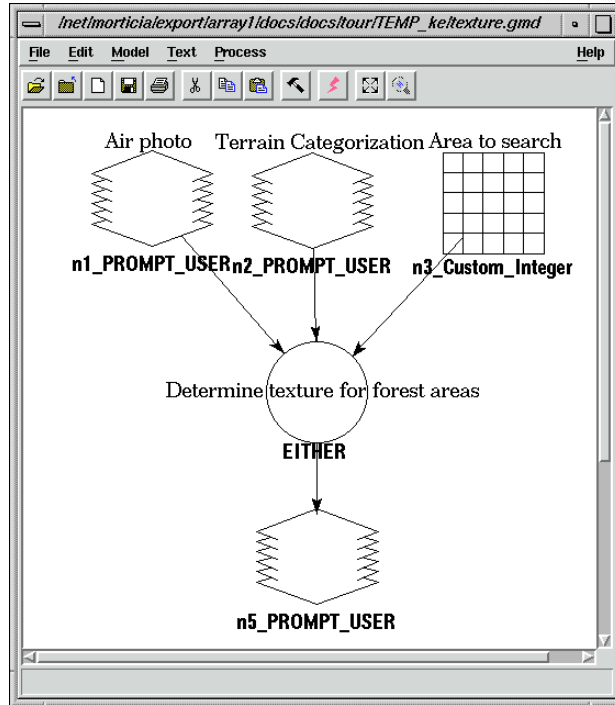

This model, **texture.gmd**, is a model that looks at every location that has been determined to be tree cover (from the **Terrain Categorization** variable), and analyzes both the air photo DN value at that location and the DN values in surrounding locations (using a  $3 \times 3$  moving window) to determine local texture. This spatial variable is then used in the **Close Forest (no go)**, **Medium Density forest (slow go)**, and **Open Forestry (go)** hypotheses to determine the relative density of the tree canopy, and thereby determine the relative ease of vehicular passage.

6. Select **File | Close** from the Spatial Modeler viewer.
7. Click **Close** in the Variable Props dialog displaying properties for the **Tree Density model** variable.

## Check Buildings Hypothesis

The **Buildings (no go)** hypothesis is a simple expert rule that states that if the **Terrain Categorization** shows that a location is a type of urban area, it is impassable.

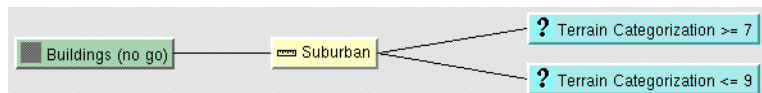

Confidences are kept low on these rules so that they do not override the **Wide Road** and **Narrow Road** hypotheses. That is, roads within urban areas are still traversable.

1. Double-click on the **Suburban** rule attached to the **Buildings (no go)** hypothesis.

The Rule Props for the **Suburban** rule open.

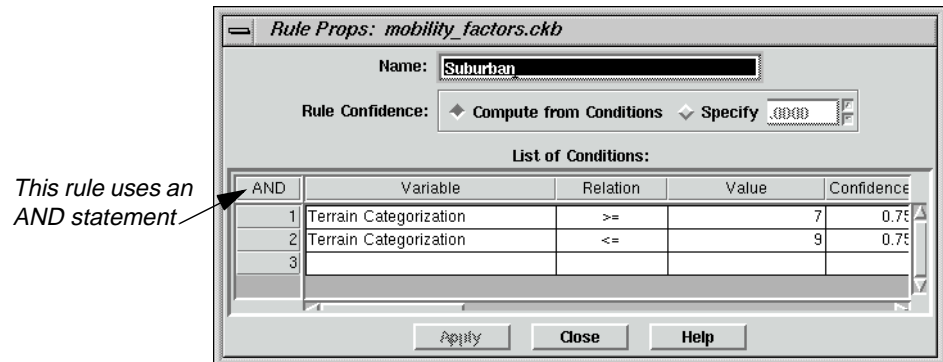

2. In the Rule Props dialog, move the horizontal scroll bar all the way to the right.
3. Notice that the **Confidence** values are set to **0.75**.
4. Click **Close** in the Rule Props dialog.

## Identify Choke Points

The final hypothesis is another good example of spatially enabling the IMAGINE Expert Classifier. This hypothesis identifies choke points in the road network—points where the road narrows considerably and traffic cannot circumnavigate, thereby representing a potential no go point. The main example of this is bridges.

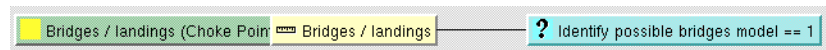

Identification of bridges might sound like an easy proposition: find roads that are on water. However, the only information we have on location of water bodies is from the landcover classification (the **Terrain Categorization** variable), which cannot identify water that flows below other features. Consequently, a more complex approach is required.

1. Click the **Variables** tab in the Knowledge Engineer dialog.

Double-click the *Identify possible bridges model* variable

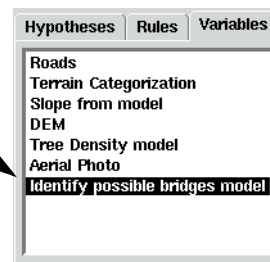

2. In the **Variables** tab, double-click **Identify possible bridges model**.

The Variable Props dialog for the variable **Identify possible bridges model** opens.



This variable also uses a Graphic Model

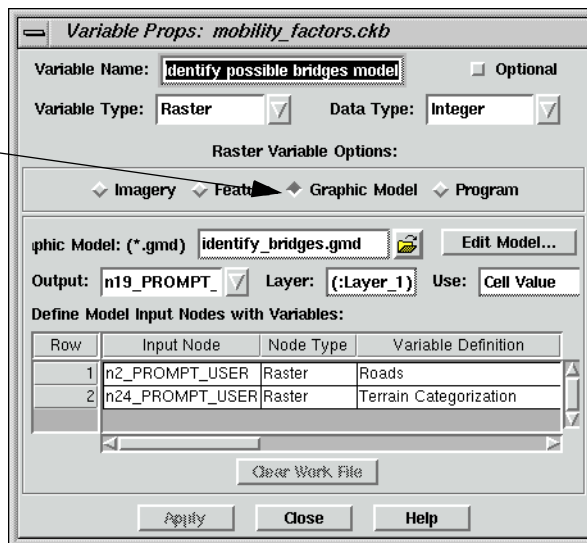

3. Click the **Edit Model** button in the Variable Props dialog.

The model used to identify potential bridges, **identify\_bridges.gmd**, shows the expert rule.

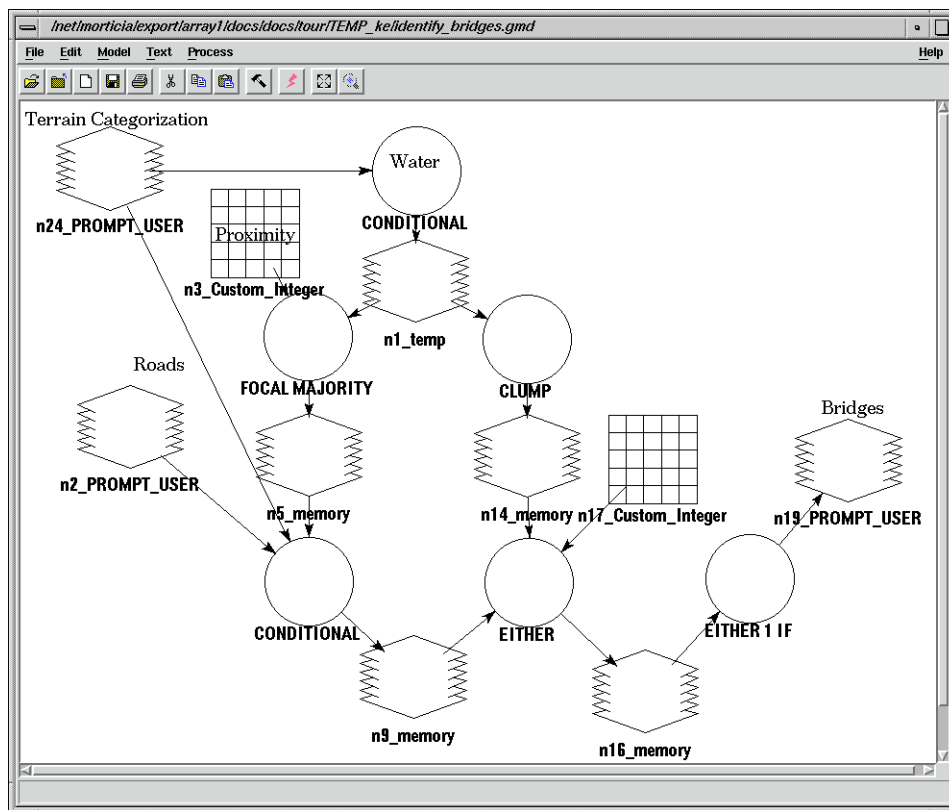

Since you cannot immediately identify roads over water, you must instead look at roads in close proximity to water. This could be done by buffering (performing a Search function) on the roads and overlaying this with the location of water pixels. However, many roads simply run alongside lakes or rivers and do not necessarily therefore constitute a choke hazard. Instead, it is better to identify roads that occur in close proximity to at least two discrete water bodies (i.e., one on either side of the bridge).

Therefore, **identify\_bridges.gmd** first identifies all water pixels from the landcover classification. These locations are fed into two processes. The first finds all locations that are in close proximity to water by using a  $5 \times 5$  circular moving window). These are then overlain with road locations (from **Roads** and **Terrain Categorization** variables) to identify roads in close proximity to water. At the same time, the water pixels are run through a Clump process to produce uniquely numbered, discrete water bodies. A Focal Diversity function is then used at each location determined to be a road in close proximity to water to determine how many of these discrete water bodies are close by. If more than two water bodies are identified, then that road is flagged as being a potential bridge or other choke point. This information is then used in the **Bridges/landings (Choke Point)** expert rule.

This provides a clear example of how the IMAGINE Expert Classifier can be used to integrate spatially aware rules. In this case, the values of neighboring pixels are analyzed to help determine the land use (bridge as opposed to road) of the target pixels.

4. Click the Close Model icon, or select **File | Close** from the Spatial Modeler viewer.



Also note that the **Bridges/landings (Choke Point)** hypothesis is always going to occur at pixel locations that have also met the requirements to be in the **Wide Road** or **Narrow Road** classes (it is extremely difficult to create expert rules that are always mutually exclusive). Consequently, the **Confidence** values on the **Bridges/landings** rule have been set higher than those for the normal road rules. In this way, the **Bridges/landings (Choke Point)** hypothesis always takes precedence in the classifications.

5. In the Knowledge Engineer dialog, double-click the **Bridges/landings** rule.

The Rule Props dialog for **Bridges/landings** opens.



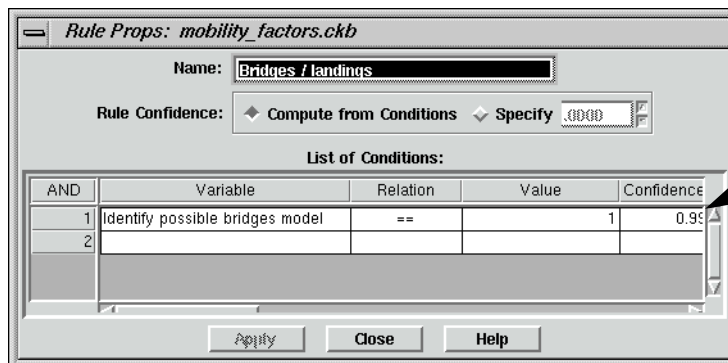

Check the Confidence value

6. Move the horizontal scroll bar to the right see the **Confidence** value.
7. Note that the **Confidence** of the variable **Identify possible bridges model** is set to **0.99**.
8. Click **Close** in the Rule Props dialog.
9. Click **Close** in the Variable Props dialog.

## Run the Expert Classification

1. In the Knowledge Engineer dialog, click the Run icon, or select Evaluate | Test Knowledge Base.



The Knowledge Classification (Test Mode) dialog opens on the **Select the Classes of Interest** panel.

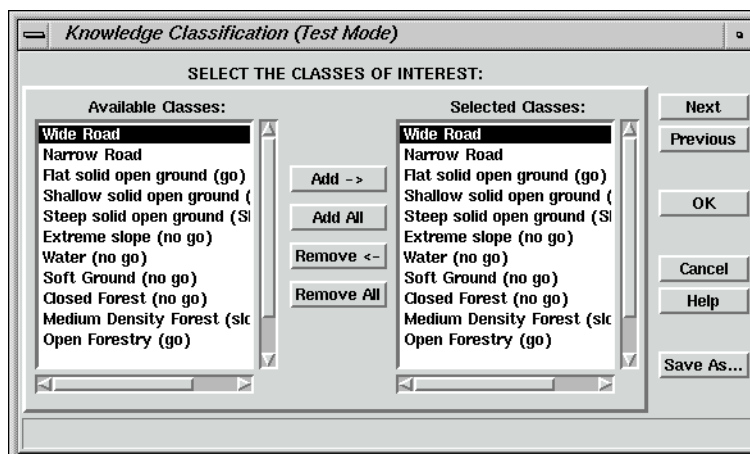



## Create a Portable Knowledge Base

You want to see results for all of the classes; therefore, you can proceed to the next panel.

2. Click the **Next** button in the Knowledge Classification (Test Mode) dialog.

The **Select the Input Data for Classification** panel opens.

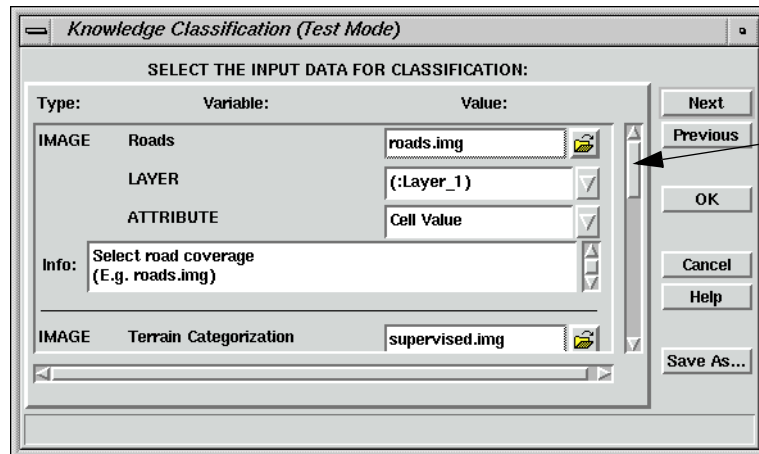

Use the scroll bar to see the values assigned to variables

This panel enables you to identify the files to be used as variables, which were set to the **Leave Undefined (Prompt Analyst)** state.

3. Use the vertical scroll bar to see the variables and their corresponding files.

In this Knowledge Base, the **Roads** variable is associated with **roads.img**, the **Terrain Categorization** variable is associated with **supervised.img**, the **DEM** variable is associated with **30meter.img**, and the **Aerial Photo** variable is associated with **mason\_ap.img**.

4. Click **Next** in the Knowledge Classification (Test Mode) dialog.

The **Select Classification Output Options** panel opens.

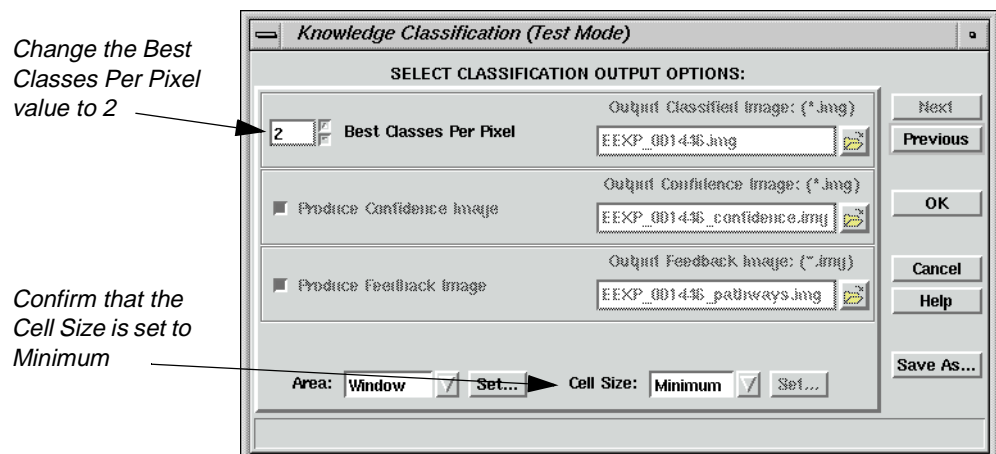

5. Change the **Best Classes Per Pixel** value to **2**.



# IMAGINE Expert Classifier™

6. Confirm that the **Cell Size** is set to **Minimum**.
7. Click **OK** in the **Select Classification Output Options** panel of the Knowledge Classification (Test Mode) dialog.

Job Status dialogs open, tracking the progress of the expert classification.

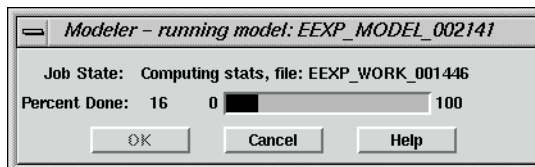

8. When the job is complete, click **OK** in the Job Status dialogs.



*You can set a preference to automatically close the Job Status dialog after computation is complete. It is located in the **User Interface & Session** category of the Preference Editor.*

When the process is complete, the classification displays in a Viewer.

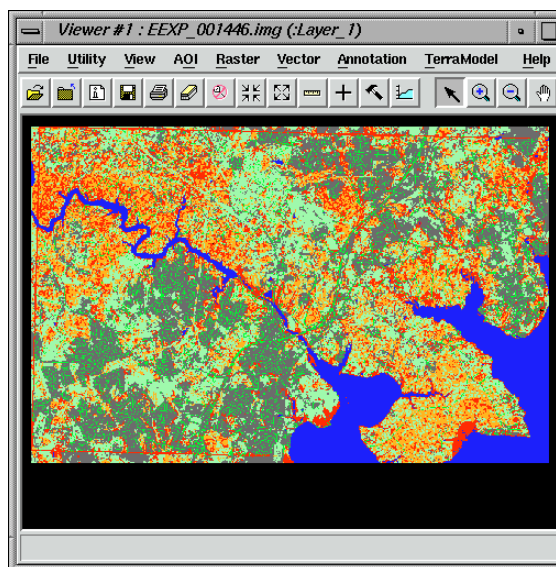

## Evaluate River Areas

Now that the classification is complete, you should zoom in and see what the IMAGINE Expert Classifier designated as potential bridges.

1. In the Viewer tool bar, click the Zoom In icon.





2. Move your mouse into the Viewer, and click on an area of the river.
3. Click as many times as necessary in order to see the detail of the area.

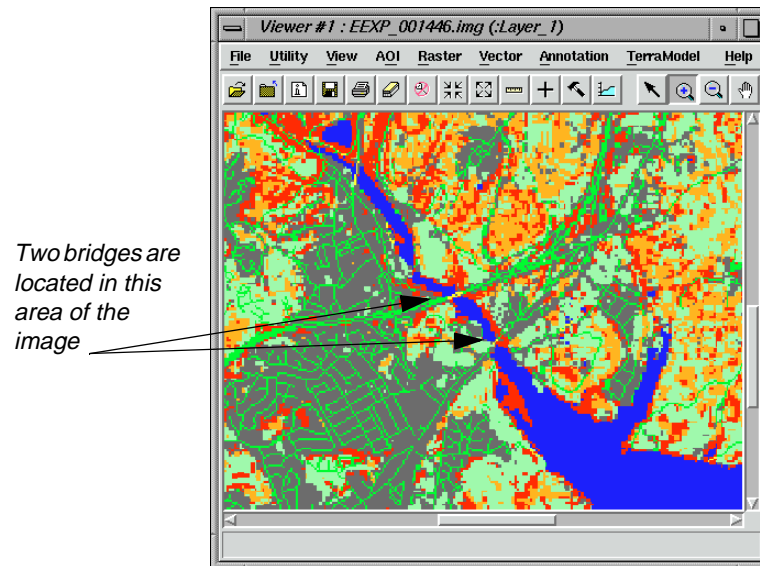

4. Zoom in further until you can see yellow pixels at bridge locations, which indicate the **Bridges/landings (Choke Point)** class.



If you refer back to the Knowledge Engineer dialog, you can see that the **Bridges/landings (Choke Point)** hypotheses has a yellow color square. Therefore, pixels in that class are also yellow.

### Use Pathway Feedback

You can use the pathway feedback cursor to analyze the classification in the Viewer.

1. Click the Classification Pathway Feedback Mode icon in the Knowledge Engineer dialog.





The Classification Path Information dialog opens.

*The class beneath the inquire cursor is identified here*

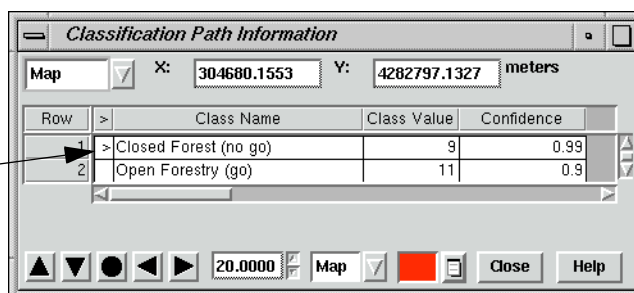

In the Classification Path Information dialog, the second row in the CellArray specifies the second most likely class (hypothesis) for this pixel (since you requested the **2 Best Classes Per Pixel** on page 537).

An inquire cursor is placed in the Viewer containing the classification, and the pathway it corresponds to is highlighted in red in the Knowledge Engineer dialog.

2. Click the Select icon from the Viewer tool bar.



3. Using your mouse click, hold, and drag the inquire cursor to a yellow pixel in the Viewer.

The Classification Path Information dialog and the Knowledge Engineer dialog update accordingly.

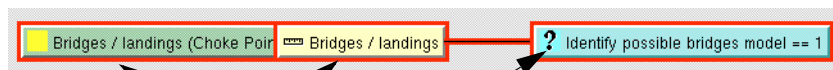

*The hypothesis, rule, and condition are outlined in red*

4. Continue to move the inquire cursor around in the Viewer, and analyze the results in the Classification Path Information dialog and the Knowledge Engineer dialog.
5. When you are finished, click **Close** in the Classification Path Information dialog.



A graphical model (**clean\_up\_mobility.gmd**) is supplied for removing the salt and pepper classification pixels from the final land-use map. This model uses a focal majority, but avoids altering the road and water classes.

Select **File | Close** in the Viewer containing the classification.

Select **File | Close** in the Knowledge Engineer dialog.

The knowledge base **mobility\_factors.ckb** is an example of how a knowledge base can be built to take into account spatial rather than (or as well as) spectral per-pixel relationships to derive land use information. It also shows how commonly repeated tasks can be automated for repeating within an organization, or to repeat the same methodology at other organizations. Instead of running several separate spatial models and trying to integrate the results, the entire process is captured in one knowledge base that can be easily applied to other data and other locations, with consistent results.





# *Section IV*

## *IMAGINE Radar Interpreter™*



## Section IV IMAGINE Radar Interpreter™





# CHAPTER 19

## IMAGINE Radar Interpreter™

---

### Introduction

Building a model, creating a map, or rectifying an image requires certain steps, regardless of the data you are using. However, processing radar data is application-driven, so there is no preset path to follow. Therefore, this tour guide shows you how the functions work, but you have to experiment on your own data files for your own applications.

The default settings in the IMAGINE Radar Interpreter module dialogs provide acceptable results. However, it is recommended that you experiment with the settings to obtain the best results.

*NOTE: The data used in this tour guide are in the <IMAGINE\_HOME>/examples directory. Replace <IMAGINE\_HOME> with the name of the directory where ERDAS IMAGINE is installed on your system.*



*Although you can use the IMAGINE Radar Interpreter functions in any order, it is recommended that you follow this tour guide in the order that it is presented. It is important to address speckle noise before any other processing.*



*See "CHAPTER 5: Enhancement" in the ERDAS Field Guide for more theoretical information about using the Radar module.*



*The IMAGINE Radar Interpreter is part of the IMAGINE Radar Mapping Suite™, which also includes IMAGINE OrthoRadar™, IMAGINE StereoSAR DEM™, IMAGINE IFSAR DEM™, and the Generic SAR Node.*



*Approximate completion time for this tour guide is 45 minutes.*

---

### Suppress Speckle Noise

In this section, you display two images—one that has been despeckled, and one raw radar image. The objective is to make the two images look alike by using the Speckle Suppression function.

With all speckle suppression filters there is a trade-off between noise reduction and loss of resolution. Each data set and each application has a different acceptable balance between these two factors. The IMAGINE Radar Interpreter module Speckle Suppression filters have been designed to be versatile and gentle in reducing noise (and resolution).

In this section, you also calculate the coefficient of variation for an image. This variable is required to fine-tune many Speckle Suppression filters.



When processing radar imagery, it is very important to use the *Speckle Suppression* functions before other image processing functions to avoid incorporating speckle into the image.

## Prepare

ERDAS IMAGINE should be running and a Viewer should be open.

1. In the Viewer menu bar, select **File | Open | Raster Layer** or click the Open icon in the tool bar.



The Select Layer To Add dialog opens.

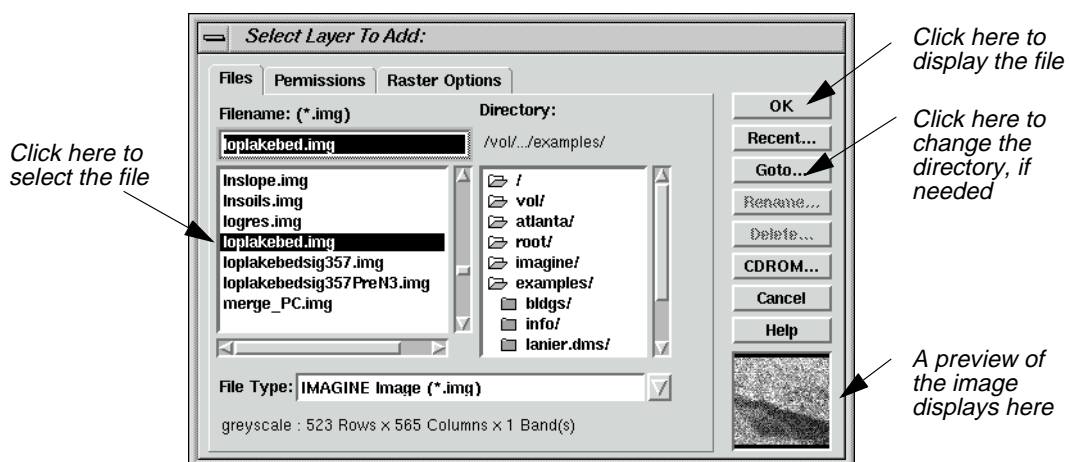

2. In the Select Layer To Add dialog under **Filename**, click on **loplakebed.img**.
3. Click **OK** in the Select Layer To Add dialog.

The **loplakebed.img** file is displayed in the Viewer.

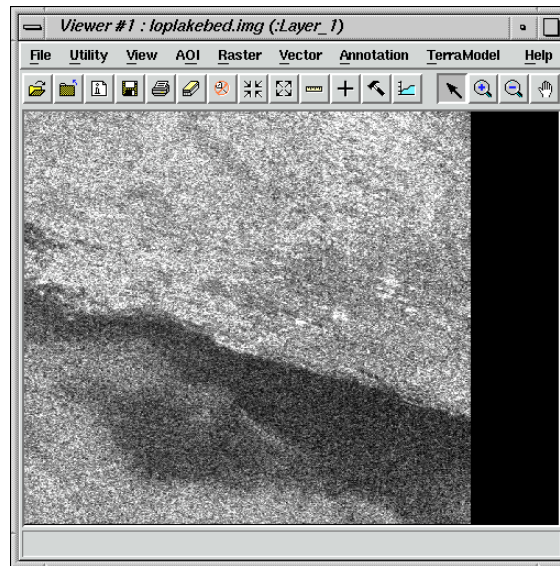

This image is a subset from imagery taken by the Shuttle Imaging Radar (SIR-A) experiment. It is L-band with 25 m pixels. This scene is the shore of Lop Nor Lake in the Xinjiang Province, Peoples' Republic of China. This is an area of desiccated overflow basins surrounded by a series of parallel, wind-scoured, sedimentary ridges. The speckle in this image is obvious.

4. In the ERDAS IMAGINE icon panel, click on the Viewer icon to open another Viewer.

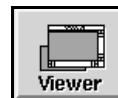

5. From the ERDAS IMAGINE menu bar, select **Session | Tile Viewers** to position and size the Viewers so that you can see the side-by-side Viewers on the screen.

This helps you to view and evaluate the resultant image after each filter pass, and then decide if another pass is needed to obtain the desired results.

6. Click on the Radar icon on the ERDAS IMAGINE icon panel.

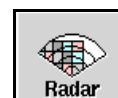

The **Radar** menu opens.



# IMAGINE Radar Interpreter™

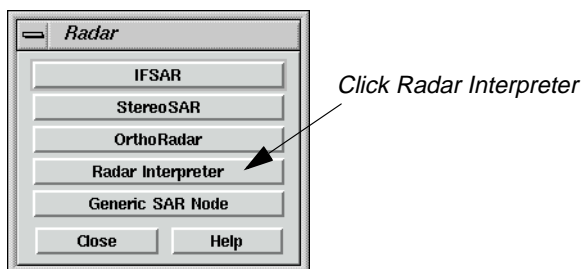

7. In the **Radar** menu, click **Radar Interpreter**.

The **Radar Interpreter** menu opens.

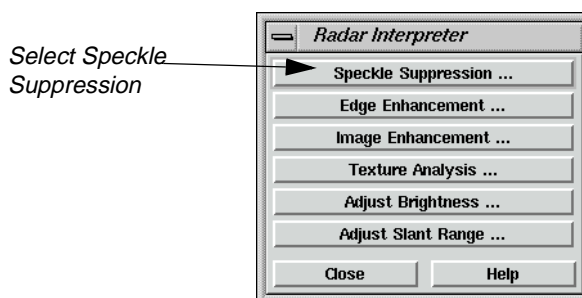

8. In the **Radar Interpreter** menu, select **Speckle Suppression**.

The Radar Speckle Suppression dialog opens.

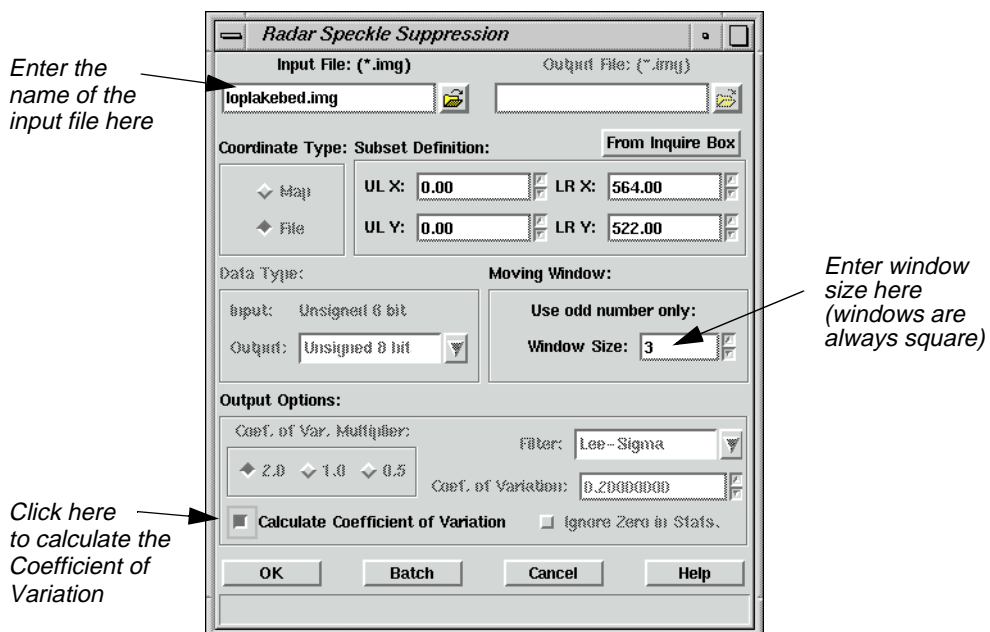

9. In the Radar Speckle Suppression dialog under **Input File**, enter the file **loplakebed.img**.

## Calculate Coefficient of Variation

Next, you calculate the coefficient of variation to be used in this function.

### Coefficient of Variation

The coefficient of variation, as a scene-derived parameter, is a necessary input parameter for many of the filters. (It is also useful in evaluating and modifying VIS/IR data for input to a 4-band composite image or in preparing a 3-band ratio color composite.)

Speckle in imaging radar can be mathematically modeled as multiplicative noise with a mean of 1. The standard deviation of the noise can be mathematically defined as:

$$\text{Standard Deviation of the noise} \Rightarrow \frac{\sqrt{\text{VARIANCE}}}{\text{MEAN}} = \text{Coefficient of Variation}$$

It is assumed that imaging radar speckle noise follows a Rayleigh distribution. This yields a theoretical value for standard deviation (SD) of .52 for 1-look radar data and SD = .26 for 4-look radar data.

The following table gives theoretical coefficient of variation values for various look-averaged radar scenes.

**Table 19-1: Coefficient of Variation Values for Look-averaged Radar Scenes**

Number of Looks (scenes)	Coefficient of Variation Value
1	.52
2	.37
3	.30
4	.26
6	.21
8	.18

1. In the Radar Speckle Suppression dialog, click the checkbox for **Calculate Coefficient of Variation**.

All the other options in the dialog are disabled, except for the **Subset Definition** and **Moving Window**. If desired, you could specify a subset area of the image for which to calculate the coefficient of variation.

2. Under **Moving Windows**, confirm that the **Window Size** is set to **3**.
3. Click **OK** in the Radar Speckle Suppression dialog.

The Radar Speckle Suppression dialog closes and a Job Status dialog displays, indicating the progress of the function.



# IMAGINE Radar Interpreter™

4. When the Job Status dialog indicates that the job is 100% complete, click **OK** (if the dialog does not close automatically).



Depending on your *eml Preferences* (under **Session | Preferences | User Interface & Session | Keep Job Status Box**), when the Job Status bar shows 100 (indicating that the job is 100% done), you must either click **OK** to close the dialog or the dialog closes automatically.

5. If it is not already displayed, open the Session Log by selecting **Session | Session Log** from the ERDAS IMAGINE menu bar.

The calculated coefficient of variation is reported in the **Session Log**, as shown in the following example.

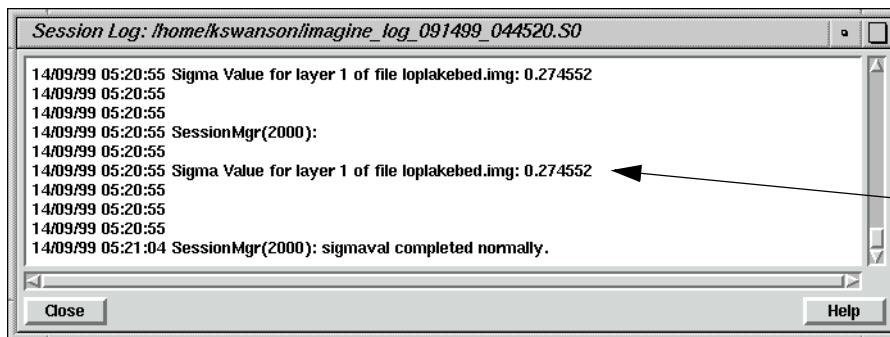

Calculated Coefficient of Variation is reported here

When using the filters in the Speckle Suppression function, you should calculate the coefficient of variation for the input image and use a number close to the calculated coefficient of variation for optimum results.

6. Click **Close** in the Session Log.

## Run Speckle Suppression Function

1. In the **Radar Interpreter** menu, select **Speckle Suppression**.

The Radar Speckle Suppression dialog opens.

2. Under **Input File**, enter the file name **loplakebed.img**.
3. Under **Output File**, enter **despeckle1.img** in the directory of your choice.

*NOTE: Be sure to remember the directory where you have saved the output file. This is important when you display the output file in a Viewer.*

4. Under **Coef. of Var. Multiplier** (under **Output Options**), click **0.5**.
5. Under **Output Options**, confirm **Lee-Sigma** is selected from the popup list next to **Filter**.



- Under **Output Options**, enter **.275** for the **Coef. of Variation** (coefficient of variation), then press Return on your keyboard.

This is the value (.275) that was reported in the Session Log when you calculated the coefficient of variation.

- Click **OK** in the Radar Speckle Suppression dialog.

The Radar Speckle Suppression dialog closes and a Job Status dialog displays, indicating the progress of the function.

- When the Job Status dialog indicates that the job is 100% complete, click **OK** (if the dialog does not close automatically).

### View Results

- In the menu bar of **Viewer #2**, select **File | Open | Raster Layer** or click the Open icon in the tool bar.



The Select Layer To Add dialog opens.

- In the Select Layer To Add dialog, select **despeckle1.img** as the file to open and click **OK**.
- Repeat steps (1. through (7. under "Run Speckle Suppression Function" to apply the Speckle Suppression function iteratively to the output images, using the following parameters for passes 2 and 3.

**Table 19-2: Speckle Suppression Parameters**

Pass	Input file	Output file	Coef. of Var.	Coef. of Var. Multiplier	Window Size
1	loplakebed.img	despeckle1.img	0.275	0.5	3 × 3
2	despeckle1.img	despeckle2.img	0.195	1	5 × 5
3	despeckle2.img	despeckle3.img	0.103	2	7 × 7



*You **MUST** enter a new output file name each time you run a speckle suppression filter. In this exercise, name each pass sequentially (e.g., **despeckle1.img**, **despeckle2.img**, **despeckle3.img**, etc.).*



## Speckle Suppression Filters

The Speckle Suppression filters can be used repeatedly in as many passes as needed. Similarly, there is no reason why successive passes must be done with the same filter. The following filtering sequence might be useful prior to a classification.

**Table 19-3: Filtering Sequence**

Filter	Pass	Sigma Value	Sigma Multiplier	Window
Lee	1	0.26	NA	3 × 3
Lee	2	0.22	NA	5 × 5
Local Region	3	NA	NA	7 × 7 or 9 × 9

## Use Histograms to Evaluate Images

Next, the ImageInfo method of histogram display is explained.

## Histograms

Viewing the histograms of an image is often helpful in determining: the need for filtering, the type of filter to use, and the results of filtering.

You can see a histogram of an image through:

- **Tools | Image Information | View | Histogram** from the ERDAS IMAGINE menu bar
- **Utility | Layer Info | View | Histogram** from the Viewer menu bar

1. Select **Tools | Image Information** from the ERDAS IMAGINE menu bar.

The ImageInfo dialog opens.

2. Select **File | Open** from the ImageInfo menu bar to select a file. You can also click on the Open icon in the ImageInfo tool bar to select a file.



3. In the Image Files dialog, click on **loplakebed.img** to select it and then click **OK**.

The information for **loplakebed.img** displays in the ImageInfo dialog.



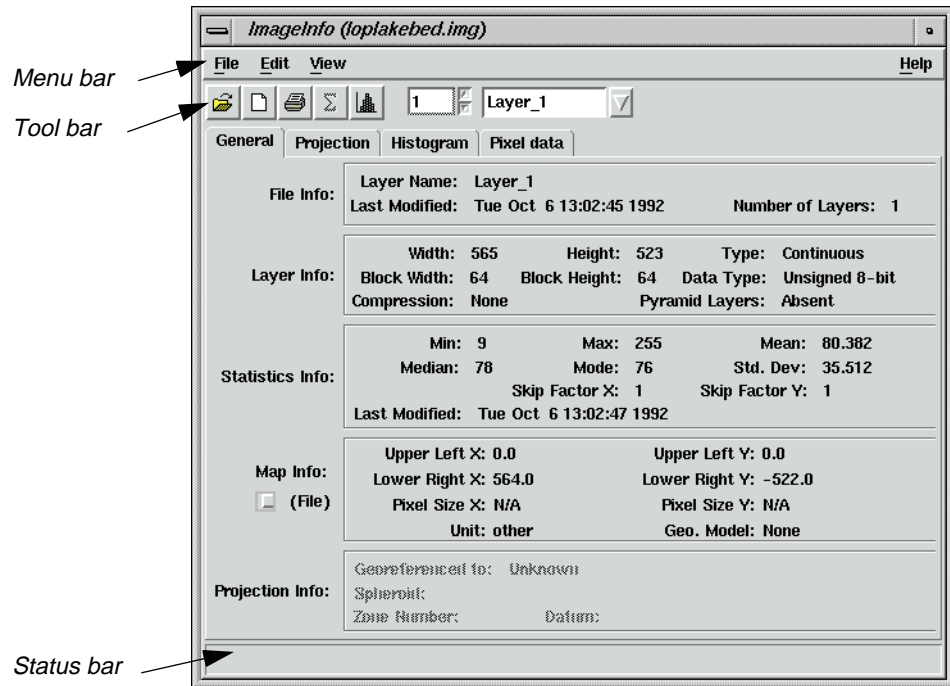

4. In the ImageInfo dialog, select **View | Histogram**, or click the Histogram icon.



The histogram for **loplakebed.img** displays.

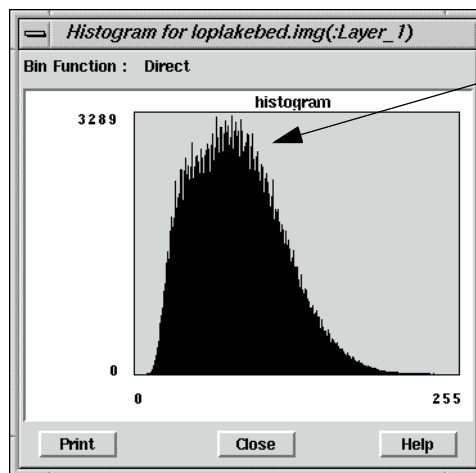

*The presence of spikes indicates the need for speckle reduction.*

5. Select **File | New** from the ImageInfo dialog menu bar to open another ImageInfo dialog.



# IMAGINE Radar Interpreter™

A second ImageInfo dialog opens.

6. Click on the Open icon in the new ImageInfo dialog.



7. In the Open File dialog, select **despeckle1.img** from the directory in which you saved it and then click **OK**.

The information for **despeckle1.img** displays in the ImageInfo dialog.

8. In the ImageInfo dialog, click the Histogram icon.

The histogram for **despeckle1.img** displays.

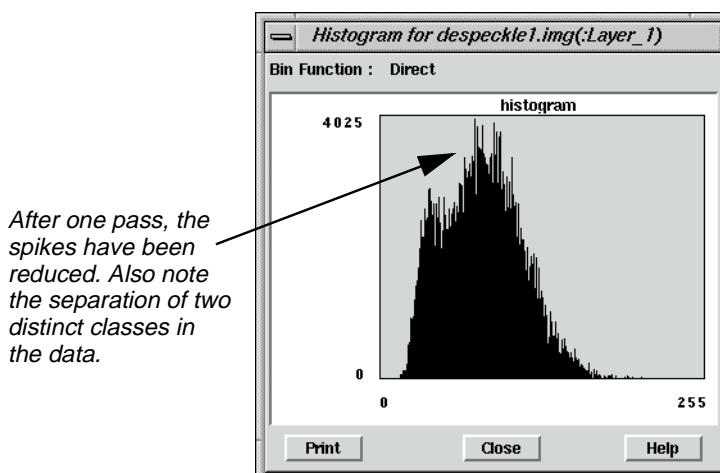

9. Repeat steps (5. through (8. of "Use Histograms to Evaluate Images" to view the subsequent passes of speckle reduction performed (**despeckle2.img**, **despeckle3.img**).
10. When finished, click **Close** in the Histogram viewers.
11. Select **File | Close** from the ImageInfo dialogs.
12. Select **File | Clear** in both Viewers.

## Enhance Edges

In this exercise, you create two images—one that is processed from the original image with the Edge Enhancement function, and one that is processed from the final result of the Speckle Suppression exercise. The objective is to demonstrate the effectiveness of Speckle Suppression prior to Edge Enhancement.

The Edge Enhancement functions in the IMAGINE Radar Interpreter module are similar to the Convolution and Neighborhood options in Image Interpreter.

*NOTE: You can use the Edge Enhancement functions on any type of image—not just radar data.*



1. From the **Radar Interpreter** menu, select **Edge Enhancement**.

The Edge Enhancement dialog opens.

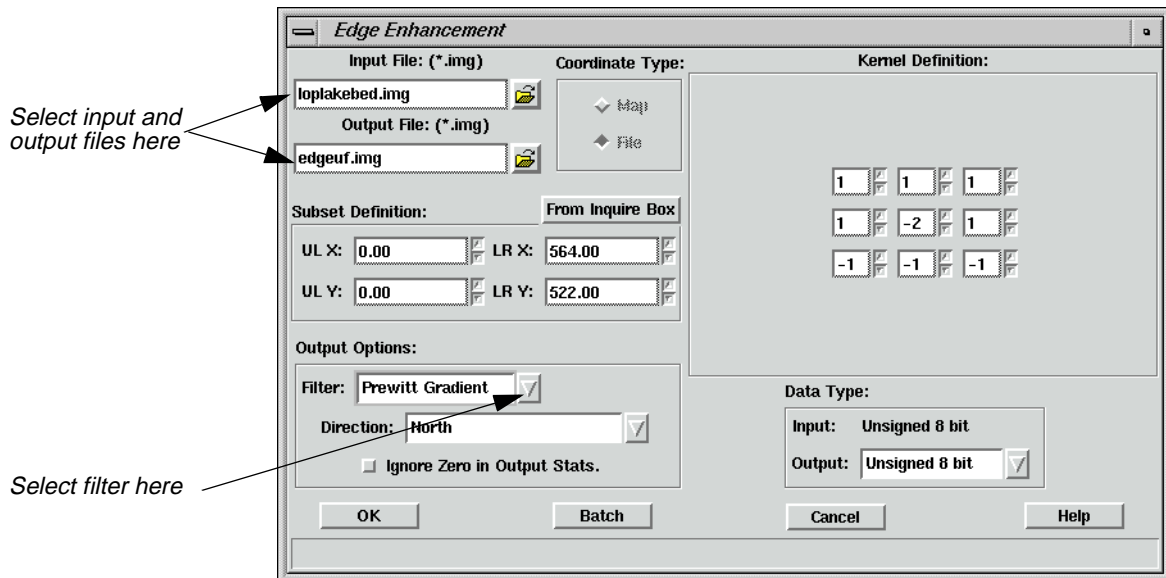

2. In the Edge Enhancement dialog under **Input File**, enter **loplakebed.img**.
3. Under **Output File**, enter **edgeuf.img** in the directory of your choice.
4. Under **Output Options**, click on the **Filter** popup list and select **Prewitt Gradient**.
5. Click **OK** in the Edge Enhancement dialog.

The Edge Enhancement dialog closes and a Job Status dialog displays, indicating the progress of the function.

6. Repeat steps (1. through (5., using **despeckle3.img** as the **Input File** and **edgess.img** as the **Output File**.

## View Results

1. In Viewer #1, select **File | Open | Raster Layer**.

The Select Layer To Add dialog opens.

2. In the Select Layer To Add dialog, click on the file **edgeuf.img**, then click **OK**.

This is the edge-filtered file derived from the unfiltered radar image file.



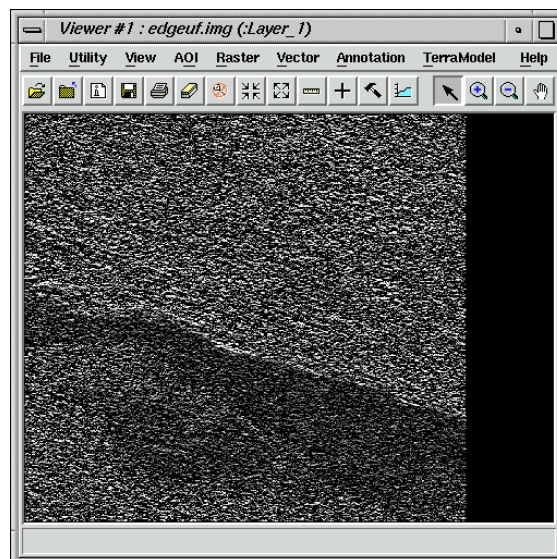

3. If necessary, start another Viewer. In Viewer #2, select **File | Open | Raster Layer**.
4. In the Select Layer To Add dialog, click the file **edgess.img**, then click **OK**.

This is the edge filtered file derived from the speckle-suppressed file.

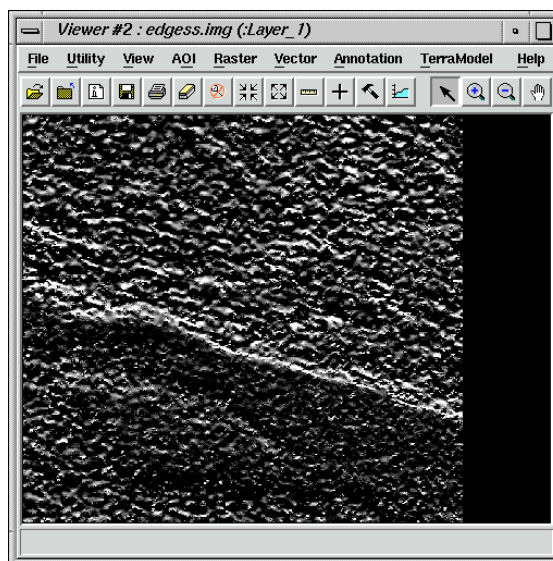

5. In the ERDAS IMAGINE menu bar, select **Session | Tile Viewers** to position and size the Viewers so that you can see both of them at once on the screen.

The results should clearly show a more visible lake bed in the image that was speckle filtered (**edgess.img**). As an experiment, you may now want to take the unfiltered, edge-enhanced image (**edgeuf.img**) and pass it through the same Speckle Suppression process done previously. Comparing the result of this experiment with **edgess.img** should show whether it is better to perform speckle suppression before or after edge enhancement.

You can experiment with other edge enhancement filters or proceed to the next section.

6. When you are finished comparing the images, select **File | Clear** in Viewer #1 and Viewer #2.

---

### Enhance Image

The IMAGINE Radar Interpreter module provides three image enhancement categories:

- Wallis Adaptive Filter
- luminance modification
- sensor merge

#### *Wallis Adaptive Filter*

The Wallis adaptive filter is designed to adjust the contrast stretch of an image using only the values within a local region (defined by the window size), which makes it widely applicable. Three possible implementations of this technique are provided: Bandwise, IHS, and PC.

- In the Bandwise operation, the adaptive filter is passed over each band sequentially.
- In the IHS implementation, the input RGB image is transformed into IHS space. The adaptive filter is only passed over the intensity (I) component. The image is then transformed back into RGB.
- In the PC implementation, the input bands are transformed into principal components. The filter is only passed over PC-1. An inverse principal component transform is then performed.

In this section, you apply the Wallis adaptive filter function to an image and observe the results.

### Wallis Adaptive Filter

#### Prepare

Make sure the IMAGINE Radar Interpreter module is running, and display the file **radar\_glacier.img** in a Viewer.



# IMAGINE Radar Interpreter™



1. In the **Radar Interpreter** menu, select **Speckle Suppression**.

The Radar Speckle Suppression dialog opens.

2. In the Radar Speckle Suppression dialog, enter **radar\_glacier.img** as the **Input File**.
3. Type in **despeckle4.img** (in the directory of your choice) as the **Output File**.
4. Select **Gamma-MAP** from the **Filter** popup list.
5. Click **OK** in the Radar Speckle Suppression dialog to filter the image.

The Radar Speckle Suppression dialog closes and a Job Status dialog displays, indicating the progress of the function.

6. Click **OK** in the Job Status dialog when the process is complete.
7. Select **Image Enhancement** from the **Radar Interpreter** menu.

The **Image Enhancement** menu opens.

Click Wallis Adaptive Filter

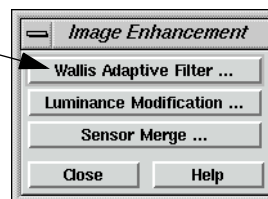

8. Click on **Wallis Adaptive Filter** in the **Image Enhancement** menu.

The Wallis Adaptive Filter dialog opens.

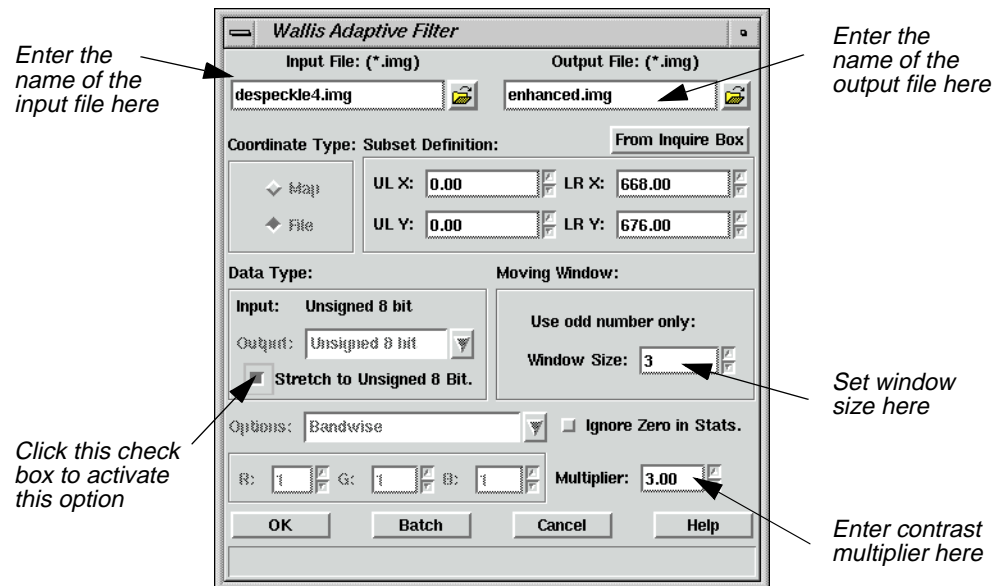

9. In the Wallis Adaptive Filter dialog under **Input File**, enter the file **despeckle4.img**.
10. Under **Output File**, enter the name **enhanced.img** in the directory of your choice.
11. Under **Data Type**, click **Stretch to Unsigned 8 Bit**.
12. Under **Moving Window**, confirm that the **Window Size** is set to **3**.

Rough images usually require smaller window sizes ( $3 \times 3$ ), whereas smooth, or cleaner, images can tolerate larger window sizes.

13. Set the **Multiplier** to **3.00**.
14. Click **OK** in the Wallis Adaptive Filter dialog.

The Wallis Adaptive Filter dialog closes and a Job Status dialog displays, indicating the progress of the function.

15. When the Job Status dialog indicates that the job is 100% complete, click **OK** (if the dialog does not close automatically).

### View Results

1. In the menu bar of Viewer #2, select **File | Open | Raster Layer**.

The Select Layer To Add dialog opens.

2. In the Select Layer To Add dialog, select the file **enhanced.img** and then click **OK**.



# IMAGINE Radar Interpreter™

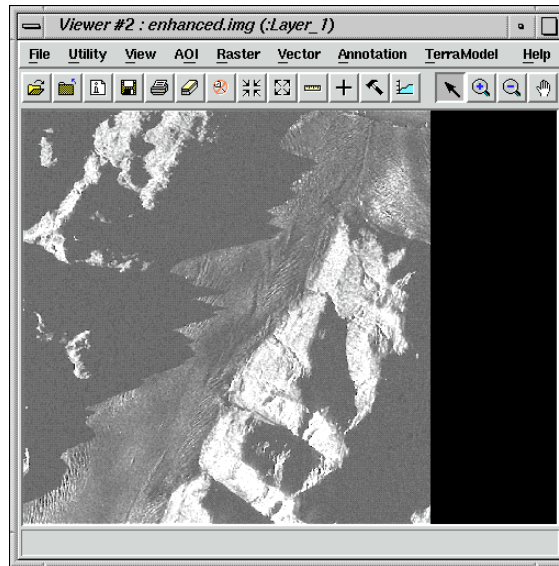

3. Examine the differences between the two files.
4. When you are finished comparing the images, select **File | Clear** in Viewer #1 and Viewer #2.

## Apply Sensor Merge

Next, you apply the **Sensor Merge** function to an image and observe the results.

This package of algorithms enables you to combine imagery from different sensors. Examples of this would be radar with TM imagery or multifrequency radar with aeromagnetic data. Three different families of techniques are available: Principal Component, IHS, and Multiplicative (these are similar to those in the Wallis Adaptive Filter option).



### Principal Component

In using the **Principal Component** techniques, you have the option to modify the gray scale image in any of the following ways.

- **Remap**—rescales the gray scale image to the range of PC-1.
- **Hist. Match**—matches the histogram of the gray scale image to PC-1.
- **Multiply**—rescales the gray scale image into the 0-1 range and then multiplies the gray scale by PC-1.
- **None**—replaces PC-1 with the input gray scale image.

### IHS

Using the **IHS** family, two options exist.

- **Intensity**—rescales the gray scale image to the numerical range of the intensity (I) and then substitutes it for I.
- **Saturation**—rescales the gray scale image to the numerical range of saturation (S) and then substitutes it for S.

### Multiplicative

The **Multiplicative** technique remaps the gray scale image to a 0-1 range. Each band is then sequentially multiplied by the remapped gray scale image.

1. If it is not already open, open the **Image Enhancement** menu by selecting **Image Enhancement** from the **Radar Interpreter** menu.
2. In the **Image Enhancement** menu, select **Sensor Merge**.

The Sensor Merge dialog opens.



# IMAGINE Radar Interpreter™

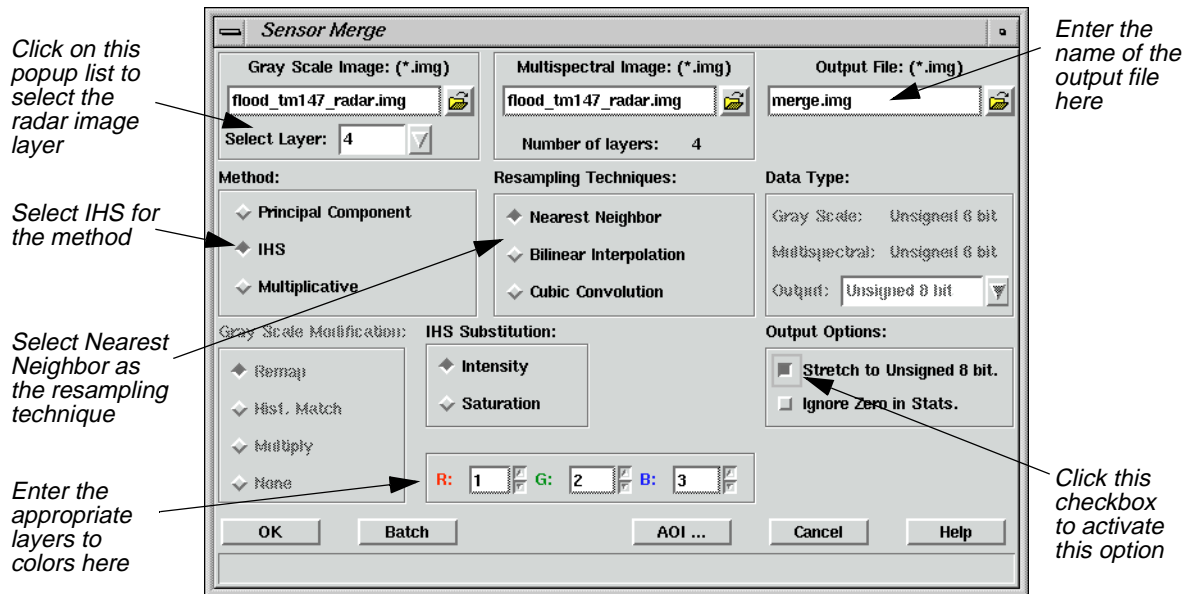

3. In the Sensor Merge dialog under **Gray Scale Image**, enter **flood\_tm147\_radar.img**.
4. Click on the **Select Layer** popup list and select **4** (the radar image layer).
5. Enter **flood\_tm147\_radar.img** under **Multispectral Image**.
6. Enter **merge.img** as the **Output File** (in the directory of your choice).
7. Under **Method**, click **IHS**.
8. Under **Resampling Techniques**, click **Nearest Neighbor**.
9. Make sure that **Intensity** is selected under **IHS Substitution**.
10. In the **R**, **G**, and **B** boxes, enter **1** for **R**, **2** for **G**, and **3** for **B** (the TM image layers).
11. Under **Output Options**, click **Stretch to Unsigned 8 bit**.
12. Click **OK** in the Sensor Merge dialog.

The Sensor Merge dialog closes and a Job Status dialog displays, indicating the progress of the function.

13. When the Job Status dialog indicates that the job is 100% complete, click **OK** (if the dialog does not close automatically).

## View Results

1. In the menu bar of Viewer #1, select **File | Open | Raster Layer**.

The Select Layer To Add dialog opens.

2. In the Select Layer To Add dialog, click on the file **flood\_tm147\_radar.img**.
3. Click the **Raster Options** tab at the top of the Select Layer To Add dialog.
4. Under **Layers to Colors**, select **1** for **Red**, **2** for **Green**, and **3** for **Blue**.
5. Click **OK** in the Select Layer To Add dialog.

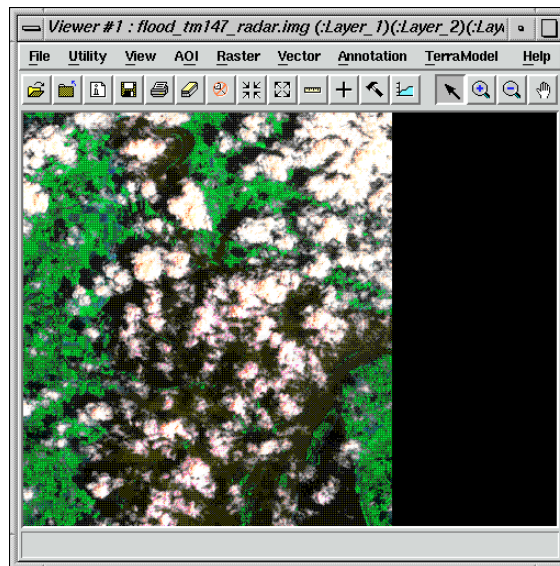

6. In Viewer #2, select **File | Open | Raster Layer**.  
The Select Layer To Add dialog opens.
7. In the Select Layer To Add dialog, click the file **merge.img**.
8. Click the **Raster Options** tab at the top of the Select Layer To Add dialog.
9. Under **Layers to Colors**, select **1** for **Red**, **2** for **Green**, and **3** for **Blue**.
10. Click **OK**.



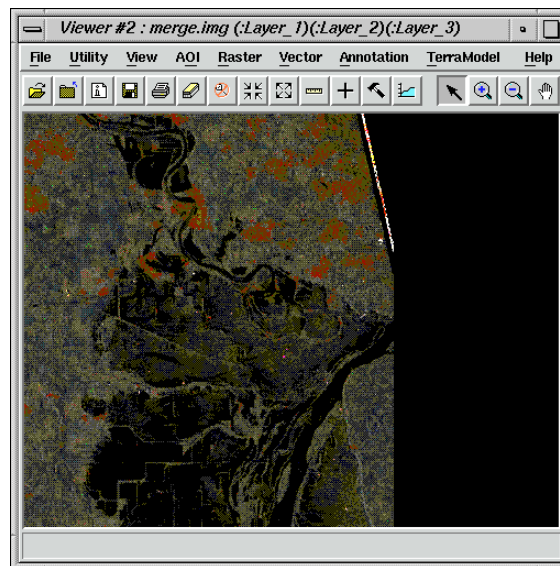

11. Examine the difference between the two files.
12. When you are finished comparing the images, select **File | Clear** in Viewer #1 and Viewer #2.
13. Click **Close** in the **Image Enhancement** menu.

## Apply Texture Analysis

Next, apply the **Texture Analysis** function to an image and observe the results.

The radar data's sensitivity to texture is an advantage over other types of imagery where texture is not a quantitative characteristic.

*NOTE: Texture analysis has been shown to be useful for geologic discrimination and vegetation classification.*

1. From the **Radar Interpreter** menu, select **Texture Analysis**.

The Texture Analysis dialog opens.

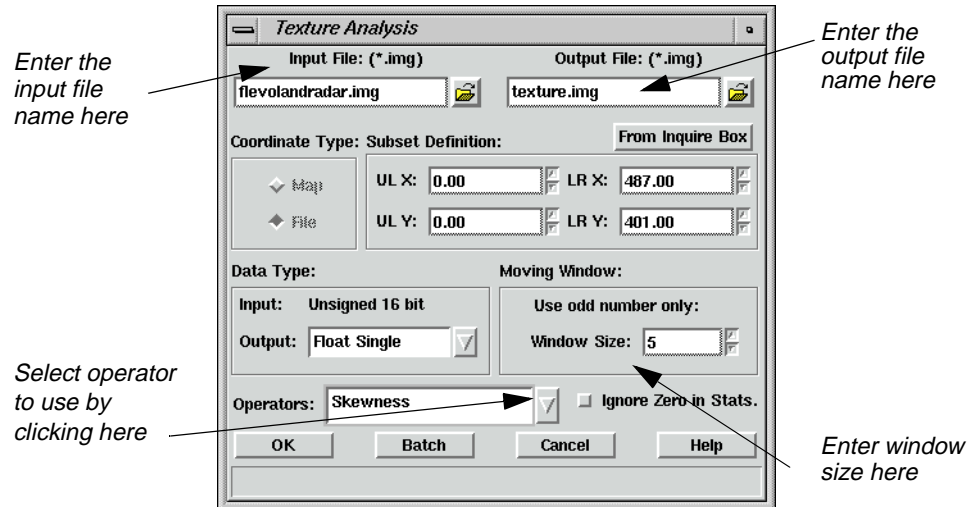

2. In the Texture Analysis dialog, enter **flevolandradar.img** as the **Input File**.
3. Enter **texture.img** (in the directory of your choice) as the **Output File**.
4. Click on the **Operators** popup list and select **Skewness**.
5. Under **Moving Window**, enter a **Window Size** of **5**.
6. Click **OK** in the Texture Analysis dialog.

The Texture Analysis dialog closes and a Job Status dialog displays, indicating the progress of the function.

7. When the Job Status dialog indicates that the job is 100% complete, click **OK** (if the dialog does not close automatically).

### View Results

1. In the menu bar of Viewer #1, select **File | Open | Raster Layer**.
2. In the Select Layer To Add dialog, click on the file **flevolandradar.img**. This is an agricultural subscene from Flevoland, Holland. This image is from the ERS-1 satellite in C-band with 20-meter pixels.



# IMAGINE Radar Interpreter™

3. Click **OK** in the Select Layer To Add dialog.

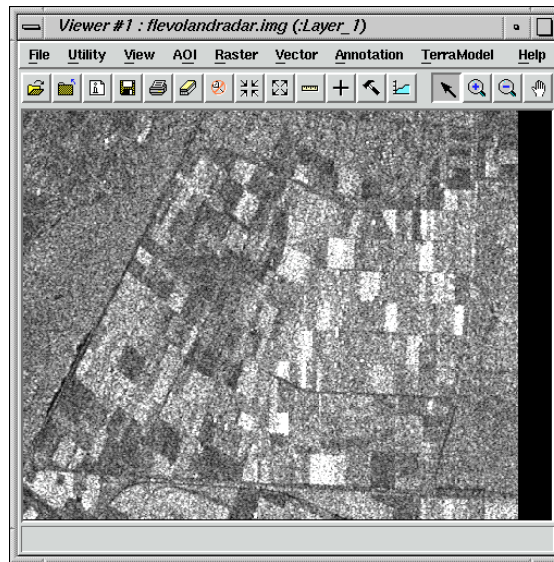

4. In Viewer #2, select **File | Open | Raster Layer**.
5. In the Select Layer To Add dialog, click the file **texture.img**, then click **OK**.

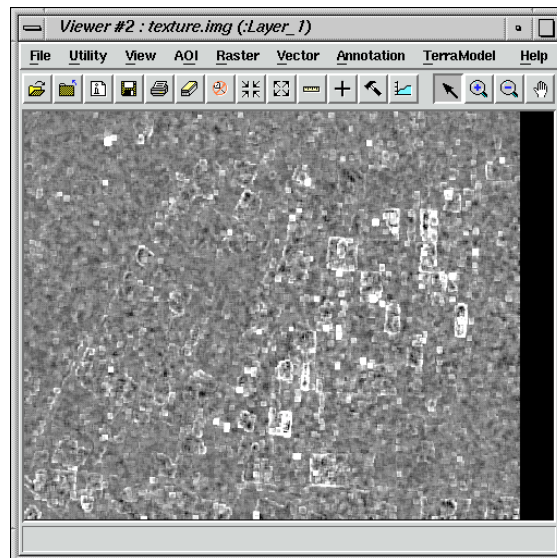

6. Examine the difference between the two files.
7. When you are finished comparing the images, select **File | Clear** in Viewer #1 and Viewer #2.

## Adjust Brightness

The **Brightness Adjustment** function works by adjusting pixel DN values so that each line of constant range has the same average. In this way, the image is adjusted to have an overall, even brightness. Therefore, you must tell ERDAS IMAGINE whether the lines of constant range are stored in rows or columns. This depends on the flight path of the sensor and the output raster it produces.

1. Select **Adjust Brightness** from the **Radar Interpreter** menu.

The Brightness Adjustment dialog opens.

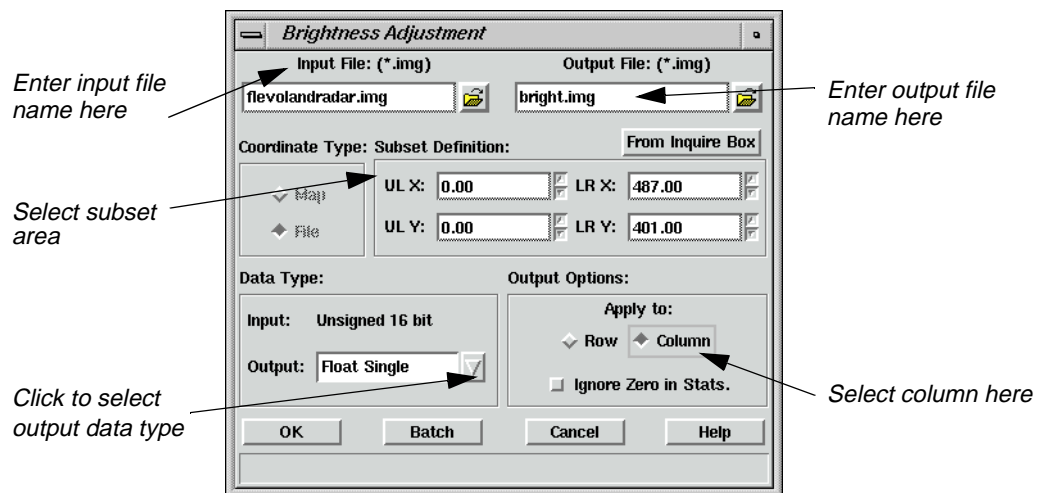

2. In the Adjust Brightness dialog under **Input File**, enter the name of the input file, **flevolandradar.img**.
3. Under **Output File**, enter the name of the output file, **bright.img**, in the directory of your choice.
4. Under **Subset Definition**, select a subset of the file if you want to apply the function to a portion of the image rather than the entire image.
5. Select the **Data Type** under **Output** file. The default is **Float Single**, which is recommended to save disk space.
6. Under **Apply to** in the **Output Options**, select **Column**.

You can often tell whether the data are stored in rows or columns by looking at the image header data or by consulting documentation supplied with the data.



Use the **Data View** option from the **Import/Export** dialog or **Tools | View Binary Data** from the **ERDAS IMAGINE** menu bar to read the image header data.

7. Click **OK** in the Adjust Brightness dialog.



# IMAGINE Radar Interpreter™

The Adjust Brightness dialog closes and a Job Status dialog displays, indicating the progress of the function.

8. When the Job Status dialog indicates that the job is 100% complete, click **OK** (if the dialog does not close automatically).
9. Select **File | Open | Raster layer** in the Viewer menu bar.
10. Navigate to the appropriate directory, then select **bright.img**.

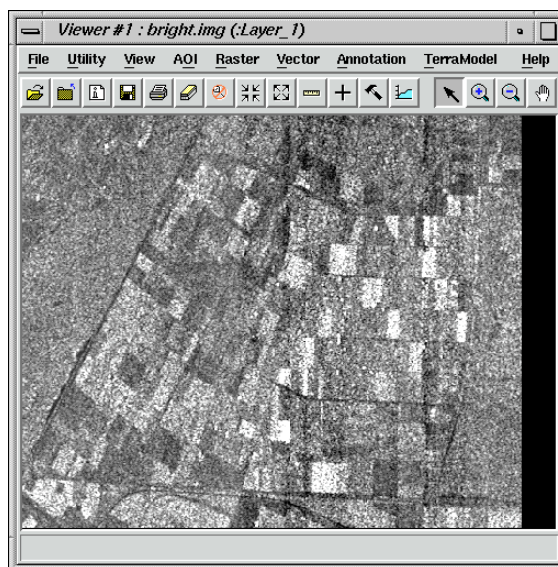

11. After processing is completed, you must view and evaluate the resultant image and decide if another pass is needed to obtain the results you want.



See "CHAPTER 5: Enhancement" in the *ERDAS Field Guide for theoretical information*.

## Adjust Slant Range

This section does not take you through an actual demonstration of the **Slant Range Adjustment** function, since the full image is required. However, when using this function, you follow the next series of steps.



*The Slant Range Adjustment function applies only to radar data.*

1. Select **Adjust Slant Range** from the **Radar Interpreter** menu.

The Slant Range Adjustment dialog opens.



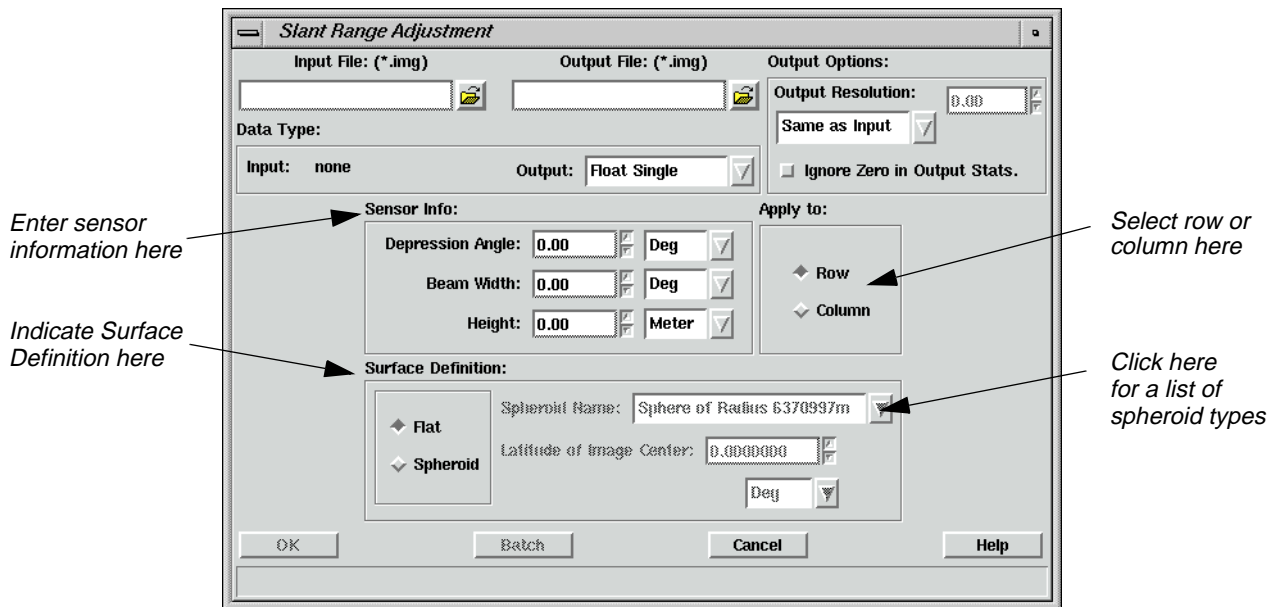

2. In the Slant Range Adjustment dialog under **Input File**, enter the name of the input file.
3. Under **Output File**, enter the name of the output file in the directory of your choice.
4. Under **Data Type**, select the data type for the **Output File** by clicking on the popup menu. The default is **Float Single**, which is recommended to save disk space but still retain precision.
5. Under **Sensor Info**, you must enter sensor-specific information that is obtained either from the data header information or from the data distributor.



Use the **Data View** option from the Import/Export dialog or **Tools | View Binary Data** from the ERDAS IMAGINE menu bar to read the image header data.

6. Under **Apply to**, select **Row** or **Column**. See the previous section on “Adjust Brightness” for information about row and column selection.
7. Under the **Surface Definition** section:
  - select **Flat** for shuttle or aircraft data, such as SIR-A or B, or AIRSAR, or
  - select **Spheroid** for satellite data (ERS-1, Fuyo (JERS-1), RADARSAT, etc.)
8. Click **OK** in the Slant Range Adjustment dialog.

A Job Status dialog displays, indicating the progress of the function.

9. When the Job Status dialog indicates that the job is 100% complete, click **OK** (if the dialog does not close automatically).
10. After processing is completed, you must view and evaluate the resultant image and decide if another pass is needed to obtain the desired results.





# *Section V*

## *IMAGINE Vector™*



## Section V IMAGINE Vector™



# CHAPTER 20

## IMAGINE Vector™

### Introduction

The IMAGINE Vector capabilities are designed to provide you with an integrated GIS package for raster and vector processing. The vector tools in ERDAS IMAGINE are based on the ESRI vector data model, therefore ArcInfo vector coverages, ESRI shapefiles, and ESRI SDE vectors can be used in ERDAS IMAGINE with no conversion.

By integrating raster and vector data into one system, you can compile a complete data base of your study area. You can overlay vectors onto current and accurate raster layers to update your vector information, including attributes. You can also use vectors to define an area of interest for an operation, such as classification or enhancement.

The IMAGINE Vector capabilities are divided into these levels:

- **Native**—vector capabilities that are native to ERDAS IMAGINE. These functions provide vector and attribute display and query using multiple selection tools, as well as vector creation and editing.
- **IMAGINE Vector module**—an add-on module for ERDAS IMAGINE that provides you with additional vector utility tools and importers/exporters of various vector formats. The utility tools include coverage clean, build, transform, create-label, raster to vector and vector to raster conversion, and a table tool for an INFO database. The importers/exporters handle the following data formats: DFAD, DGN, DLG, DXF, ETAK, IGES, SDTS, TIGER, and VPF.



---

*This tour guide mainly discusses the IMAGINE Vector module. Depending on the package you are using, you may not be able to perform all of the steps. The **Native** capabilities are discussed in "CHAPTER 5: Vector Querying and Editing" on page 109.*

This tour guide covers the following topics:

- copying vector data
- manipulating information attributes
- displaying vector layers
- changing vector symbology
- building and cleaning layers



---

*The data used in this tour guide are in the <IMAGINE\_HOME>/examples directory. Replace <IMAGINE\_HOME> with the directory where ERDAS IMAGINE is installed on your system (e.g., /usr/imagene/850).*



---

*A Digitizing Template is supplied in the information packet for ERDAS IMAGINE V8.5.*



The vector data provided with ERDAS IMAGINE do not have write permission, therefore you need to copy them to another directory so that you can edit them. However, vector layers are not simple files. They are stored in directories called workspaces. Using the simple UNIX copy commands does not copy all of the necessary files. You must use the **Copy** utility provided with ERDAS IMAGINE.

*NOTE: If you do not have the full IMAGINE Vector module, you do not need to move the data, since you cannot edit it.*



*Approximate completion time for this tour guide is 55 minutes.*

## Copy Vector Data

### Prepare

Move to the directory where you want to create your workspace. Start ERDAS IMAGINE from this directory. Make sure this is a directory in which you have read/write permissions.

1. Click on the Vector icon from the ERDAS IMAGINE icon panel.



The **Vector Utilities** menu opens.

*Click here to copy sample vector layer*

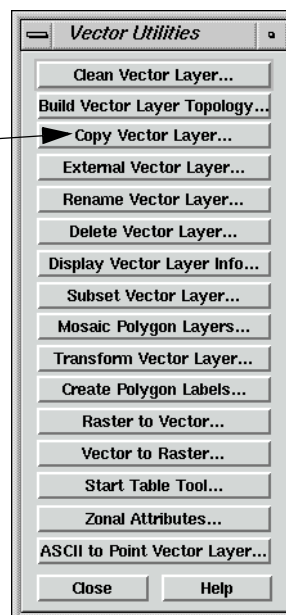

Depending on the package you have, you may not see all of these utilities.

## IMAGINE Vector

This menu lists most of the tools of the IMAGINE Vector module. Through simple dialogs generated from this menu, you can:

- **Clean** a vector coverage
- **Build** topology
- **Copy, Rename, Delete,** and **Externalize** vector layers (native functions)
- **Subset** vector layers
- **Mosaic** polygon layers
- **Transform** vector coverages from digitizer units to real-world units
- Create polygon **Labels**
- Convert **Raster to Vector** layers and **Vector to Raster** layers
- Manipulate information tables using the **Table Tool**
- Generate polygon attributes from a background image (**Zonal Attributes**)
- Convert an **ASCII File to a Point Layer**

*NOTE: Creating vector layers and vector editing tools are available through the Viewer. If you have the IMAGINE Vector module, you can also use the Import icon to access various external vector data types, such as DFAD, DGN, DLG, DXF, SDTS, TIGER, and VPF.*



*The vector utilities in the **Vector Utilities** menu should not be run on open vector layers. Close the layer you are using before running the utility, and do not attempt to open the layer until the process is complete.*

2. Select **Copy Vector Layer** from the **Vector Utilities** menu.

The Copy Vector Layer dialog opens.

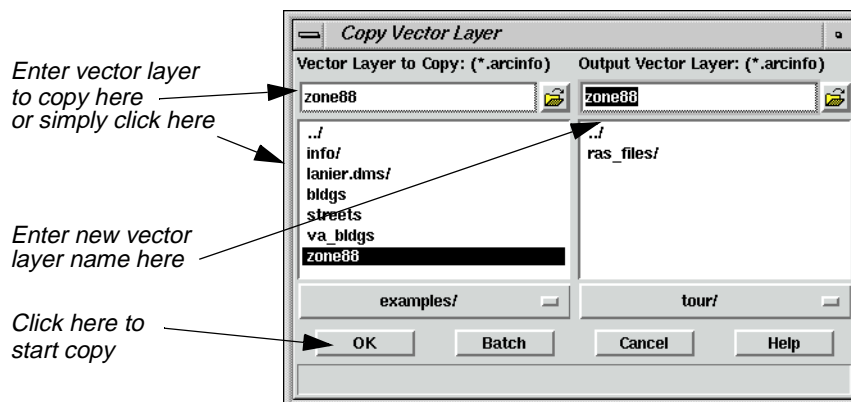

3. In the Copy Vector Layer dialog under **Vector Layer to Copy**, enter the file name **zone88**.



4. Under **Output Vector Layer**, enter **zone88** in the directory of your choice.
5. Click **OK** in the Copy Vector Layer dialog.

A Job Status dialog displays to track the progress of the function. When copying is complete, you are ready to proceed with this tour guide.

6. Click **OK** in the Job Status dialog (if it does not dismiss automatically).

The Copy Vector Layer dialog automatically closes.

7. Click **Close** in the **Vector Utilities** menu to dismiss it.

---

## Manipulate Info Files

The Table Tool is a utility for managing INFO files. It allows you to view, edit, relate, import/export, copy, rename, delete, merge, and create INFO tables.

### Prepare

ERDAS IMAGINE must be running and you must have completed the previous section, “Copy Vector Data”.

### Start Table Tool

1. Click the Vector icon in the ERDAS IMAGINE icon panel.



The **Vector Utilities** menu opens.

2. In the **Vector Utilities** menu, click on **Start Table Tool**.



The Table Tool opens.

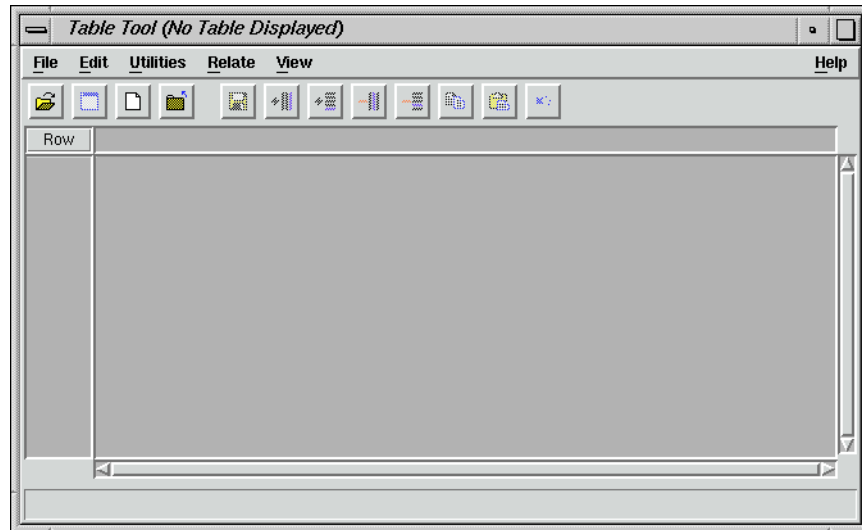

3. Click **Close** in the **Vector Utilities** menu to clear it from the screen.

### Display an INFO File

4. In the Table Tool, click the Open icon or select **File | Open** from the menu bar.



The Open Info Table dialog displays.

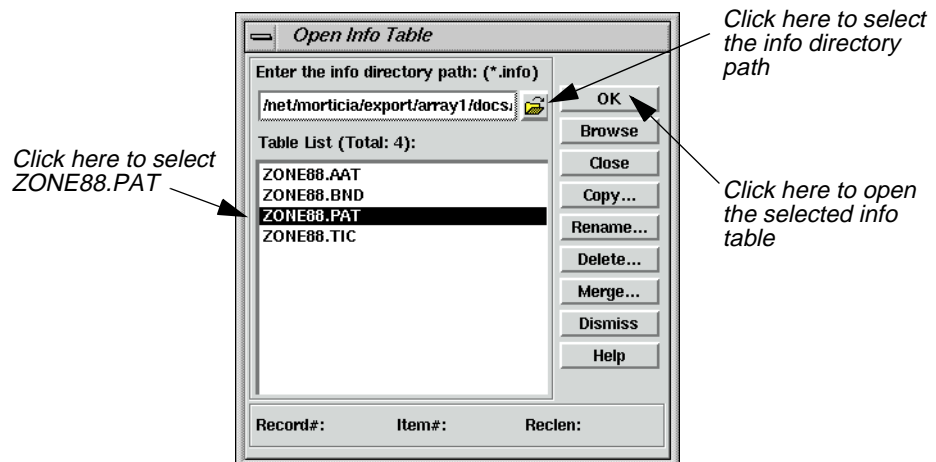

5. In the Open Info Table dialog, click the Open icon to select the **info directory path**.



The Enter the info directory path dialog opens.

- Under **Directory**, check to be sure that the directory to which you copied **ZONE88** is listed. If it is not, type that directory path in under **Filename** and press Return on your keyboard.
- In the file list under **Filename**, click **info** and then click **OK**.

The directory path and table list for **info** display in the Open Info Table dialog.

*NOTE: You can double-click on any table name to browse the table contents before clicking **OK** to open that table.*

- In the Open Info Table dialog under **Table List**, click **ZONE88.PAT** and then click **OK**.

The information for **ZONE88.PAT** displays in the Table Tool CellArray.

Row	AREA	PERIMETER	ZONE88#	ZONE88-ID	ZONING
1	-470535232.000	120641.367	1	0	0
2	18165996.000	22991.404	2	1	3
3	20490174.000	30434.029	3	2	2
4	39786940.000	48641.965	4	3	23
5	55378640.000	47938.059	5	4	15
6	3267097.500	10388.367	6	5	1
7	2791427.000	7177.106	7	6	1
8	12369503.000	20993.100	8	7	4
9	4282449.500	10005.494	9	8	8
10	9044407.000	24284.061	10	9	7
11	70444104.000	106172.047	11	10	4
12	72101.367	1212.358	12	11	21
13	2407814.250	6937.226	13	12	22

### Create a New Table

- In the Table Tool, click on the New icon.



A second Table Tool displays. The new Table Tool CellArray is blank.

- In the new Table Tool, select **File | New**.

The Create New Table dialog opens.

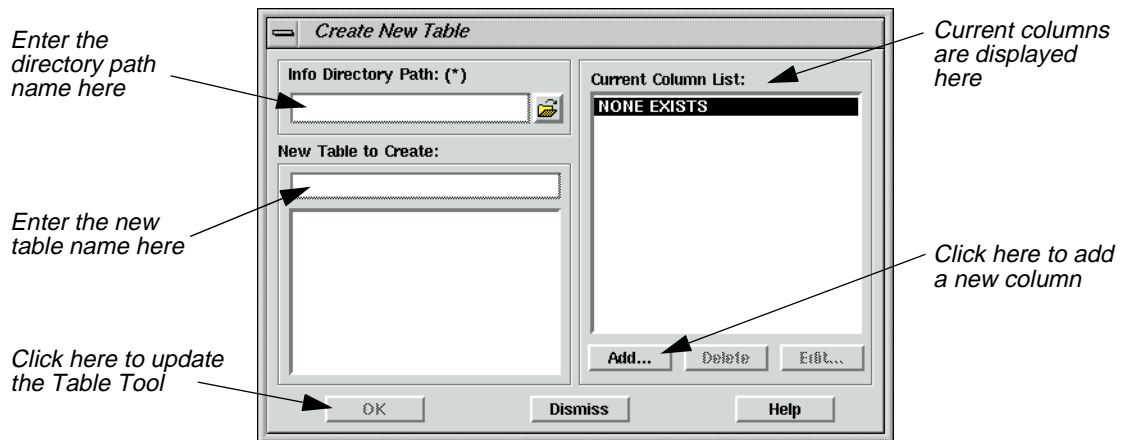

3. In the Create New Table dialog, enter the name of an **Info Directory Path** in which you have write permission, or click on the Open icon to select the directory to put the new table in.

The table list for the path you selected displays in the Create New Table dialog.

4. In the Create New Table dialog under **New Table to Create**, enter the name **ZONE88\_NEW.PAT**, and then click **Add**.

The New Column dialog opens.

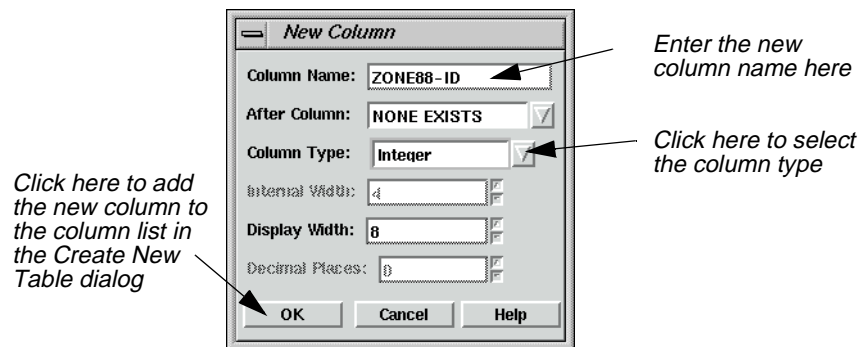

5. In the New Column dialog next to **Column Name** enter **ZONE88-ID**.
6. Next to **Column Type** click on the popup list to select **Integer**.
7. Click **OK** in the New Column dialog.
8. Click **OK** in the Create New Table dialog.

The new table is entitled **ZONE88\_NEW.PAT** and has a column entitled **ZONE88-ID**.



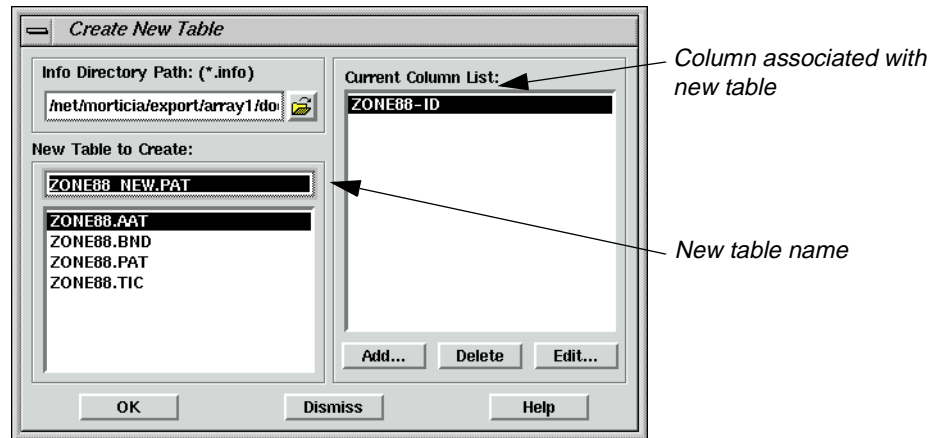

*NOTE: If you create a new table by clicking **File | New** in an existing table, the existing table is used as a template and the column definitions of the existing table are listed in the Create New Table dialog as the default columns of the new table.*

### Copy From One Table to Another

1. In the **ZONE88.PAT** Table Tool, click in the column title of **ZONE88-ID** to select that column.  
The column is highlighted in blue.
2. In the **ZONE88.PAT** Table Tool, right-hold in the column title **ZONE88-ID** to select **Column Options | Copy**.
3. In the **ZONE88\_NEW.PAT** Table Tool, click on the column title **ZONE88-ID** to select it and then right-hold **Column Options | Paste**.

The ID numbers for **ZONE88-ID** are entered into the new table, and the **ZONE88-ID** column is highlighted in blue.

### Add a Column to the Table

1. In the **ZONE88\_NEW.PAT** Table Tool, select **Edit | Add A Column** from the menu bar.  
The Add Column dialog opens. This dialog is similar to the New Column dialog.
2. In the Add Column dialog next to **Column Name** enter **NEW\_ZONING**.
3. Next to **Column Type** click on the popup list to select **Integer**.
4. Click **OK** in the Add Column dialog.

The **NEW\_ZONING** column is added to **ZONE88\_NEW.PAT**.

### Relate the Tables

Let's say that you want to compare the **Zoning** information in **ZONE88.PAT** with some new zoning information that you have just received. First, you would need to enter the new zoning information in the **NEW\_ZONING** column of the **ZONE88\_NEW.PAT** Table Tool.

1. Follow the example and enter imaginary numbers, which somewhat differ from the **ZONING** numbers, into the **NEW\_ZONING** column. (Enter the numbers by clicking in each cell, typing the number, and pressing Return on your keyboard.)

*NOTE: For this example, it would suffice to only enter numbers for rows 1 through 13. To enter numbers, select **Edit | Enable Editing**.*

Enter the new Zoning info in this column

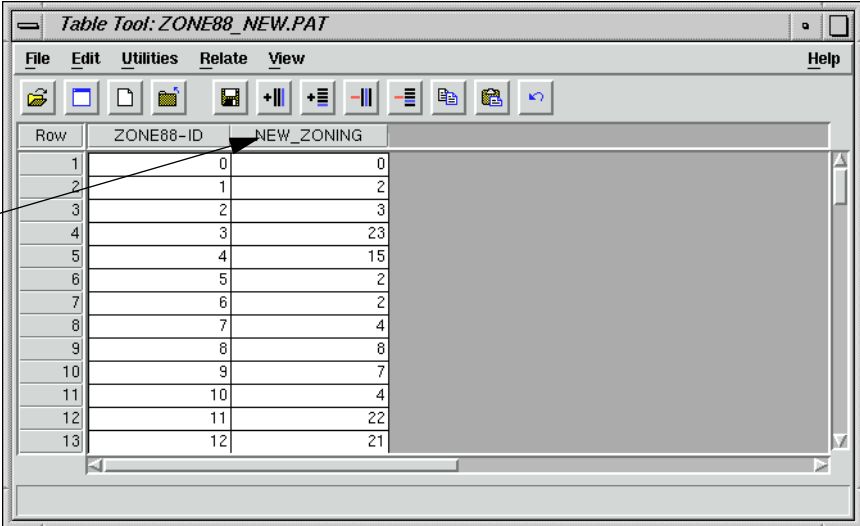

Row	ZONE88-ID	NEW_ZONING
1	0	0
2	1	2
3	2	3
4	3	23
5	4	15
6	5	2
7	6	2
8	7	4
9	8	8
10	9	7
11	10	4
12	11	22
13	12	21



If you had an ASCII file with the new data in it, you could use the **Column Options | Import** option.

2. In the **ZONE88\_NEW.PAT** Table Tool, click the Save icon to save your changes.



3. In the **ZONE88\_NEW.PAT** Table Tool, select **File | Close** from the menu bar.
4. In the **ZONE88.PAT** Table Tool, select **Relate | Relate** from the menu bar.  
The Relate Manager dialog opens.
5. In the Relate Manager dialog, click **New**.  
The Creating New Relate dialog opens.



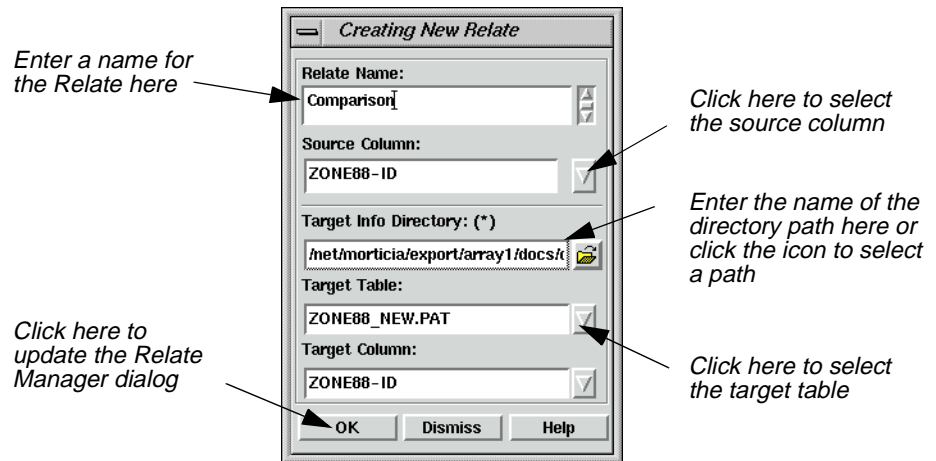

6. In the Creating New Relate dialog under **Relate Name**, enter the name **Comparison**.
7. Under **Source Column**, click on the popup list and select **ZONE88-ID**.
8. Under **Target Info Directory**, enter the path in which you saved the **ZONE88\_NEW.PAT** Table Tool (if it is not already listed).
9. Under **Target Table**, click on the popup list and select **ZONE88\_NEW.PAT**.
10. Click **OK** in the Creating New Relate dialog.

The Creating New Relate dialog closes and the information is displayed in the Relate Manager dialog.

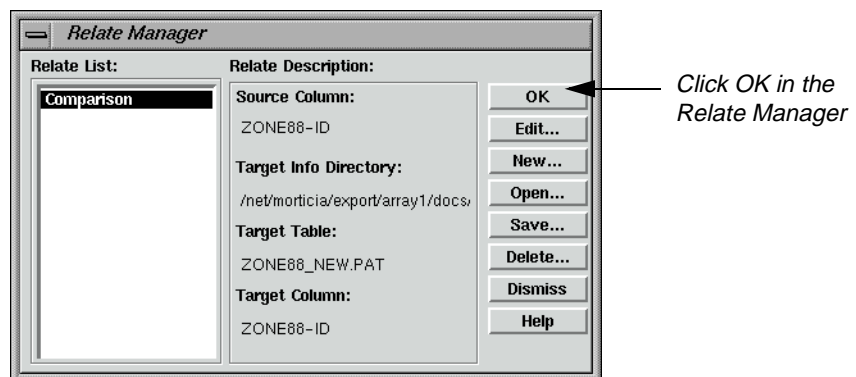

*NOTE: At this point, you can click **Save** in the Relate Manager dialog to save the relates to a table for future use.*

11. Click **OK** in the Relate Manager dialog.

**ZONE88.PAT** is now related to **ZONE88\_NEW.PAT**.

Row	ZONE88#	ZONE88-ID	ZONING	R//ZONE88-ID	R//NEW_ZONING
1	1	0	0	0	0
2	2	1	3	1	2
3	3	2	2	2	3
4	4	3	23	3	23
5	5	4	15	4	15
6	6	5	1	5	2
7	7	6	1	6	2
8	8	7	4	7	4
9	9	8	8	8	8
10	10	9	7	9	7
11	11	10	4	10	4
12	12	11	21	11	22
13	13	12	22	12	21

This relationship makes it possible for you to compare the different zoning information.

*NOTE: Selecting **Utilities | Table Merge** enables you to permanently merge the two tables together.*

12. Select **Relate | Drop** in the related Table Tool to drop the related columns.

## Change Vector Symbology

### Prepare

ERDAS IMAGINE must be running and a Viewer open.

### Display a Layer

1. In the Viewer menu bar select **File | Open | Vector Layer**.

The Select Layer To Add dialog opens.

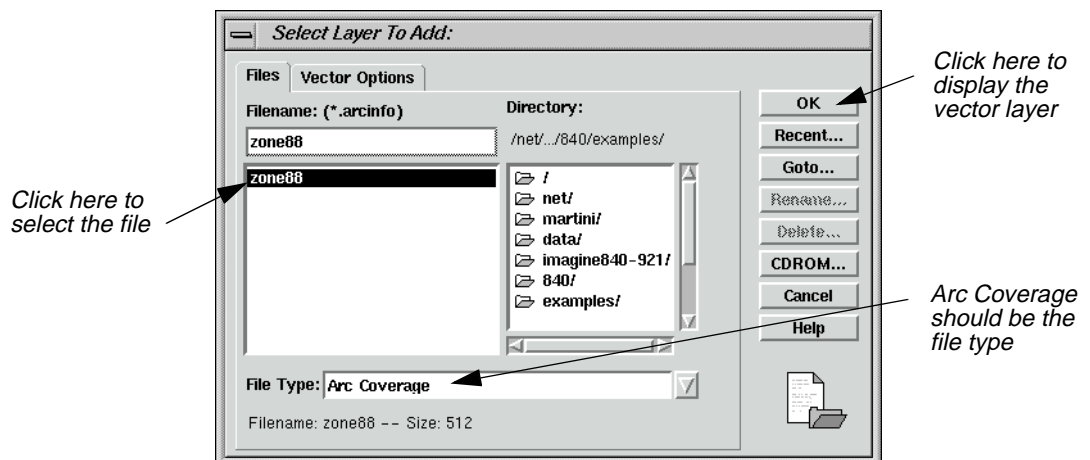

2. In the Select Layer To Add dialog, confirm that the **File Type** selected is **Arc Coverage**.
3. Under **Filename**, select **zone88**.
4. Click **OK** in the Select Layer To Add dialog to display the layer in the Viewer.

The **zone88** polygon layer is displayed in the Viewer, similar to the following example.

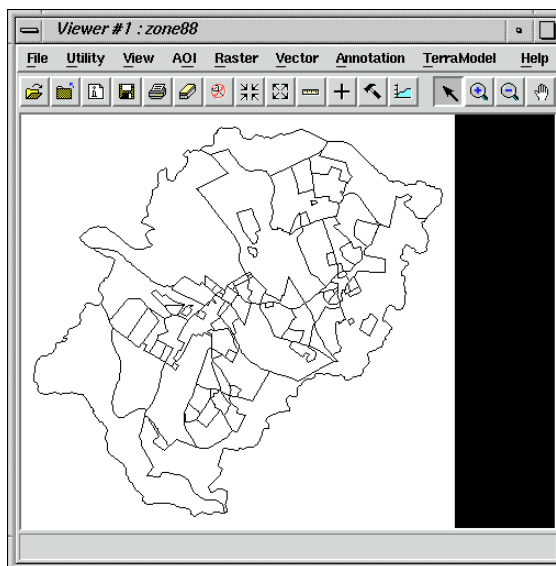

5. In the Viewer menu bar, select **Vector | Symbology**.

The Symbology dialog opens.

*Use these menu bar options to create, edit, and view symbology*

*Symbology is displayed here*

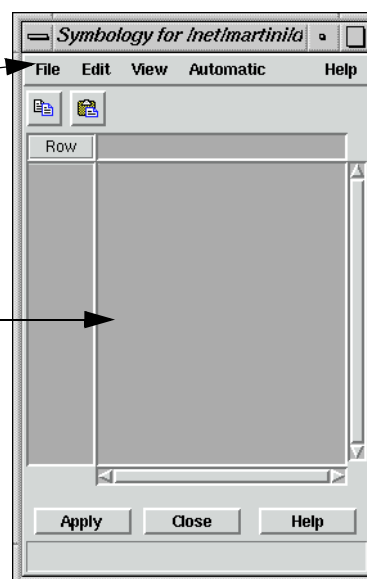

The Symbology dialog has a CellArray, but it does not yet contain any records.



## Change Vector Symbology

6. In the Symbology dialog, select **Automatic | Unique Value**.

The Unique Value dialog opens.

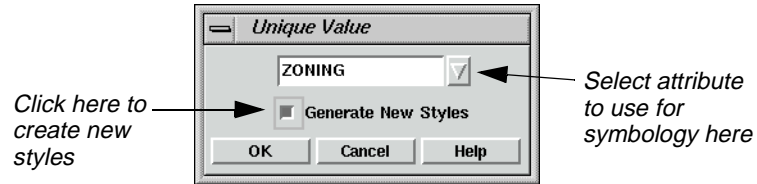

In this example, you want each zone to have a different symbology.

7. In the Unique Value dialog, click on the popup list and select **ZONING**.
8. Click the **Generate New Styles** checkbox to enable it.
9. Click **OK** in the Unique Value dialog.

The Unique Value dialog closes and the CellArray of the Symbology dialog fills with the newly generated styles.

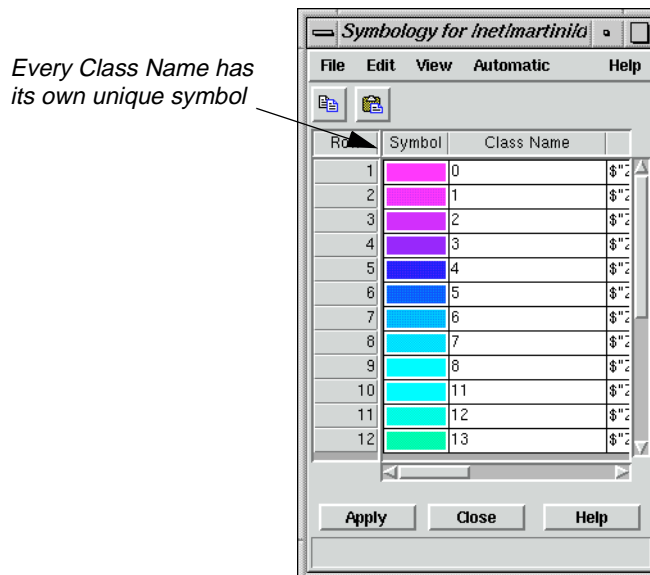

10. Click **Apply** in the Symbology dialog to apply this new symbology to the displayed layer.

The vector layer is redrawn with the new symbology. As the Symbology CellArray indicates, red areas are zone 23, green are zone 15, dark blue are zone 4, etc.



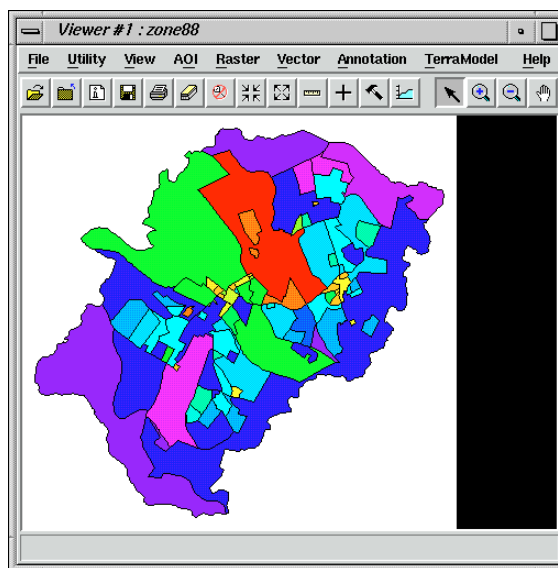

**Add Pattern Polygon Fill** Now, change the style of zone 15 (green) from a plain solid to a pattern fill over a solid.

1. In the Symbology dialog, hold in the **Symbol** column for **Zone 15 (Row number 14)** and select **Other**.

The Fill Style Chooser dialog opens.

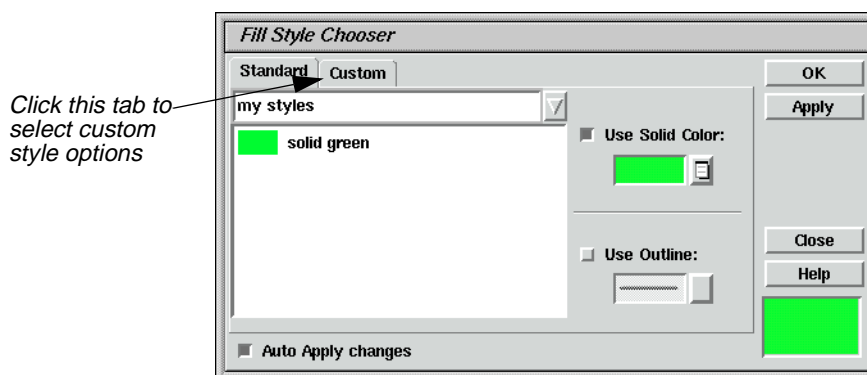

2. In the Fill Style Chooser dialog, click the **Custom** tab at the top of the dialog.
3. Click the **Use Pattern** checkbox to activate it.
4. Hold on the **Symbol** popup list and select **Other**.

The Symbol Chooser dialog opens.

## Change Vector Symbology

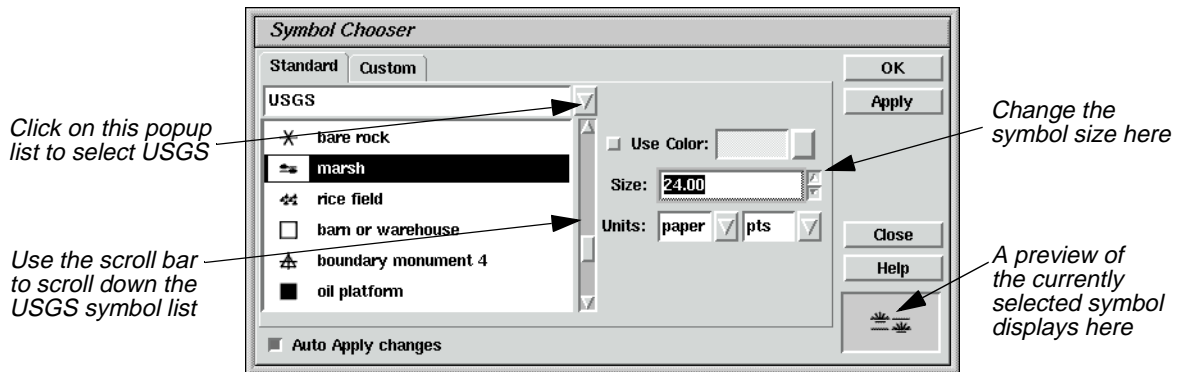

5. Click the popup list and select **USGS** to display the available USGS symbols.
6. Scroll through the symbol list under **USGS** and click on the **marsh** symbol.

*NOTE: This zone is not really marsh; this example is simply to show you how the pattern fill option works.*

7. Change the symbol **Size** to **24.00** points.

The preview window in the Symbol Chooser dialog displays the symbol and the symbol size you have selected.

8. Click **Apply** and then **Close** in the Symbol Chooser dialog.

The preview window in the Fill Style Chooser dialog displays the symbol and the symbol size you selected in the Symbol Chooser dialog.

9. In the Fill Style Chooser dialog, change both the **X Separation** and **Y Separation** to **10.00** points.

The new style is reflected in the preview window.

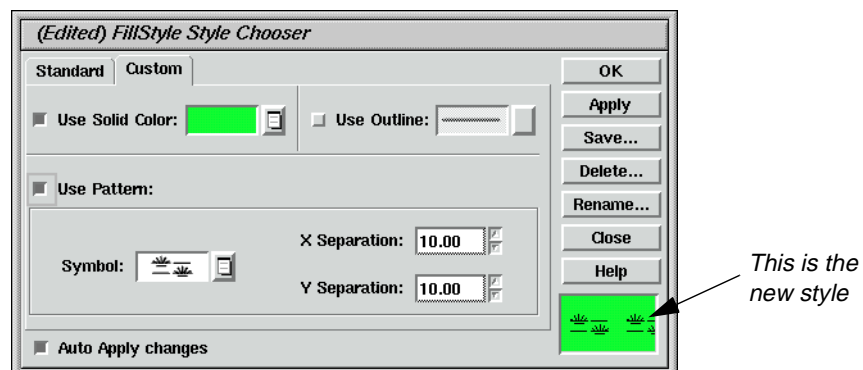

10. Click **Apply** and then **Close** in the Fill Style Chooser dialog.



The Fill Style Chooser dialog closes and the new style displays in the Symbology dialog.

11. Click **Apply** in the Symbology dialog to apply this new style to the vector layer in the Viewer.

The polygons in Zone 15 are redrawn with the pattern fill, as in the following example:

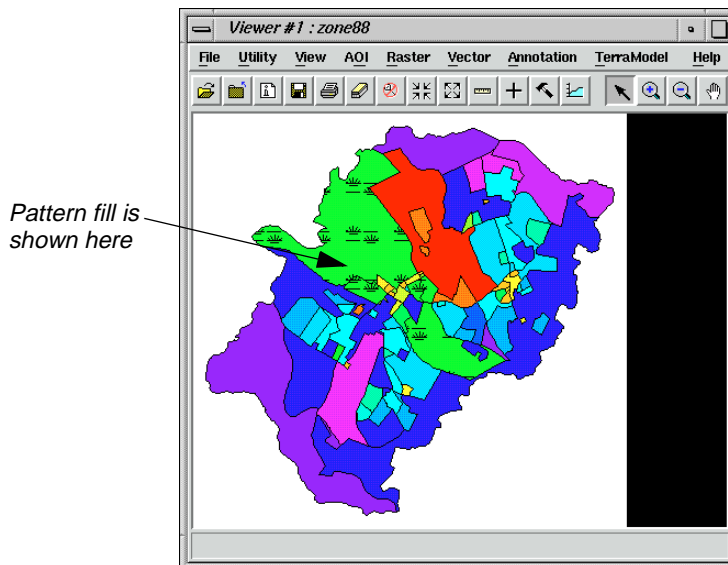

12. In the Symbology dialog, select **File | Save As**.

The Save Symbology As dialog opens.

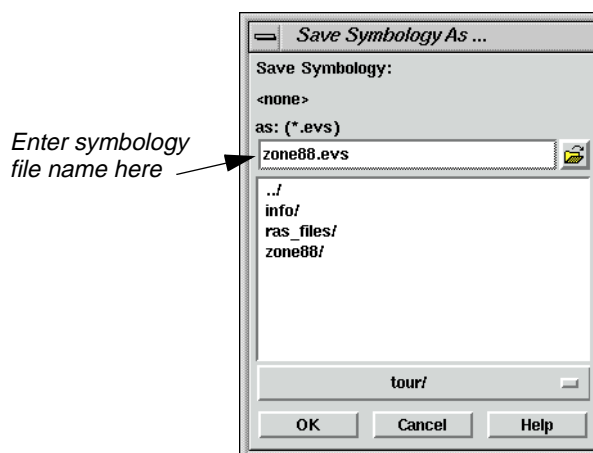

13. In the Save Symbology As dialog, enter a name for the symbology file, such as **zone88.evs**, in the directory of your choice.

If you use the same root name as your coverage, then this is the default symbology file when you open this vector layer later.

14. Click **OK** to save the file.
15. Click **Close** in the Symbology dialog.
16. Select **File | Clear** from the Viewer menu bar.

---

### Build Topology

After you have created or edited a vector layer, you must clean or build it to create or maintain the topology and reset the tabular information. If possible, it is always better to run Build instead of Clean. Clean is required only if lines intersect at locations other than nodes, or if there are dangling lines that you wish to automatically delete. This is not the case in this exercise, so you run Build on the new vector layer you just created.

The instructions for running Clean are included at the end of this tour guide for your reference.



---

*Do not clean or build an open vector layer and do not attempt to open a layer that is being cleaned or built.*



---

*In order to complete this section, you must have already completed the exercises in "CHAPTER 5: Vector Querying and Editing" on page 109. A file you created there, **zone88subset**, is used in this example.*

1. Click the Vector icon in the ERDAS IMAGINE icon panel.



The **Vector Utilities** menu opens.

2. Select **Build Vector Layer Topology** from the **Vector Utilities** menu.

The Build Vector Layer Topology dialog opens.



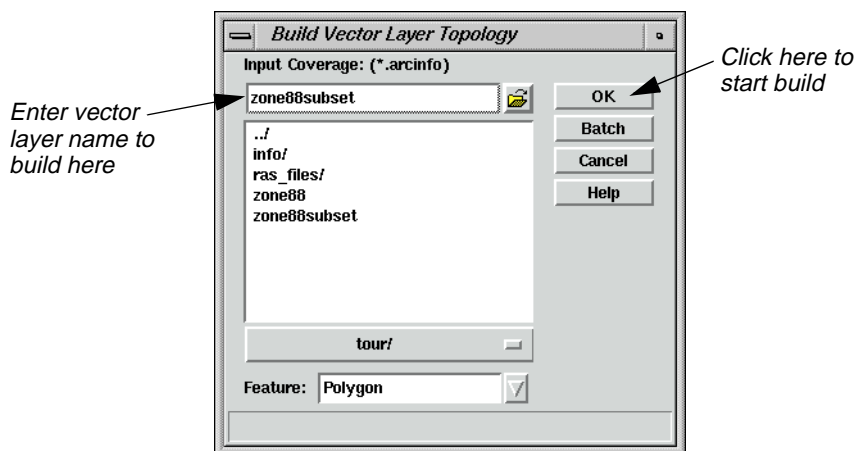

3. In the Build Vector Layer Topology dialog under **Input Coverage**, enter **zone88subset** (or the name you used for the subset in "CHAPTER 5: Vector Querying and Editing" on page 109), making sure you are in the proper directory.
4. The **Feature** should be **Polygon**.
5. Click **OK** in the Build Vector Layer Topology dialog.

A Job Status dialog displays, indicating the progress of the function.

6. Click **OK** in the Job Status dialog when the build is complete (unless your Preferences are set to clear the Job Status dialog upon job completion).



*If you get error messages when trying to display a vector layer in ERDAS IMAGINE, build or clean the layer, then try displaying it again. Do not build or clean an open vector layer and do not attempt to open a layer that is being cleaned or built.*

7. Display the vector layer and attribute information to verify that the build ran successfully.

---

## Clean Vector Layer

1. In the **Vector Utilities** menu, click **Clean Vector Layer**.

The Clean Vector Layer dialog opens.

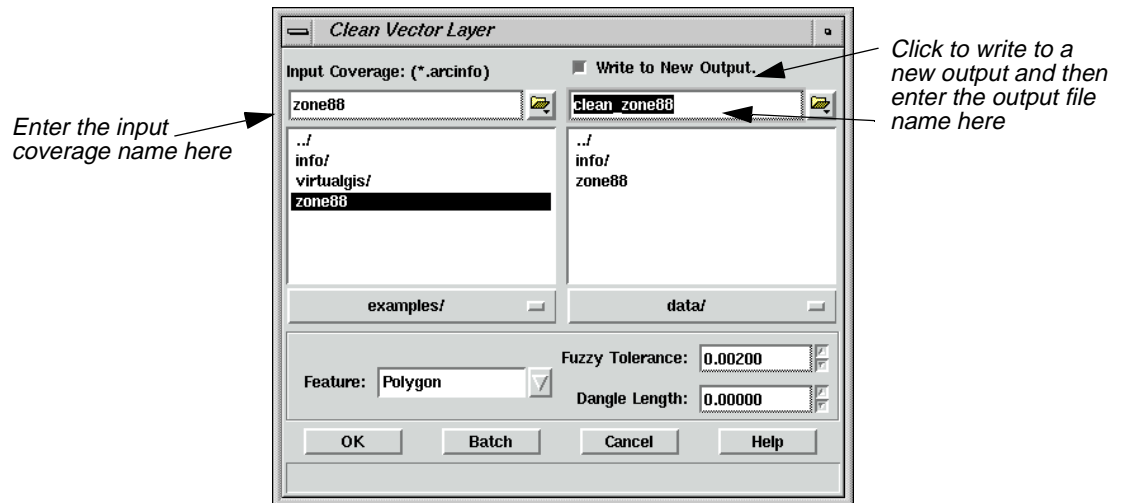

2. In the Clean Vector Layer dialog under **Input Coverage**, enter the name of the layer to be cleaned (e.g., **zone88**).
3. Click the **Write to New Output** checkbox and enter a name for the new file. This file name must not be longer than 13 characters.

*NOTE: Although creating a new file is not necessary, it is recommended.*

4. The **Feature** should be **Polygon**.
5. For this example, accept the default values for **Fuzzy Tolerance** and **Dangle Length**.

### Fuzzy Tolerance and Dangle Length

In general, fuzzy tolerance can be calculated using this formula:

$$\left( \frac{\text{scale}}{\text{\# of inches per coverage unit}} \right) \times 0.002$$

For example, an input source map at a scale of 1:600 with coverage units in feet would have a fuzzy tolerance of .1:

$$\left( \frac{600}{12} \right) \times 0.002 = 0.1$$

The dangle length value is based on the length, in map units, of the longest overshoot that exists in the coverage. The value specified removes any dangling lines that are less than, or equal to, the value you specify. Any lines longer than the length specified remain in the coverage. To measure the dangle length needed for your coverage, you can use the Measurement Tool to measure lines in the coverage.



6. Click **OK** in the Clean Vector Layer dialog.

A Job Status dialog displays, indicating the progress of the function.

7. When the clean is completed, click **OK** in the Job Status dialog (unless your Preferences are set to clear the Job Status dialog upon job completion).



---

*For more information about IMAGINE Vector, see "APPENDIX A: Additional Information" on page 595.*



# *Section VI*

## *Appendix*



## Section VI Appendix



# APPENDIX A

## Additional Information

### Classification

This section describes menus and tools you use with Classification.



*The tour guide, "CHAPTER 4: Classification", starts on page 101.*



*For an explanation of supervised and unsupervised classification, see "Supervised vs. Unsupervised Classification" on page 455.*

### Flow Chart

The basic steps for both supervised and unsupervised classification are similar.

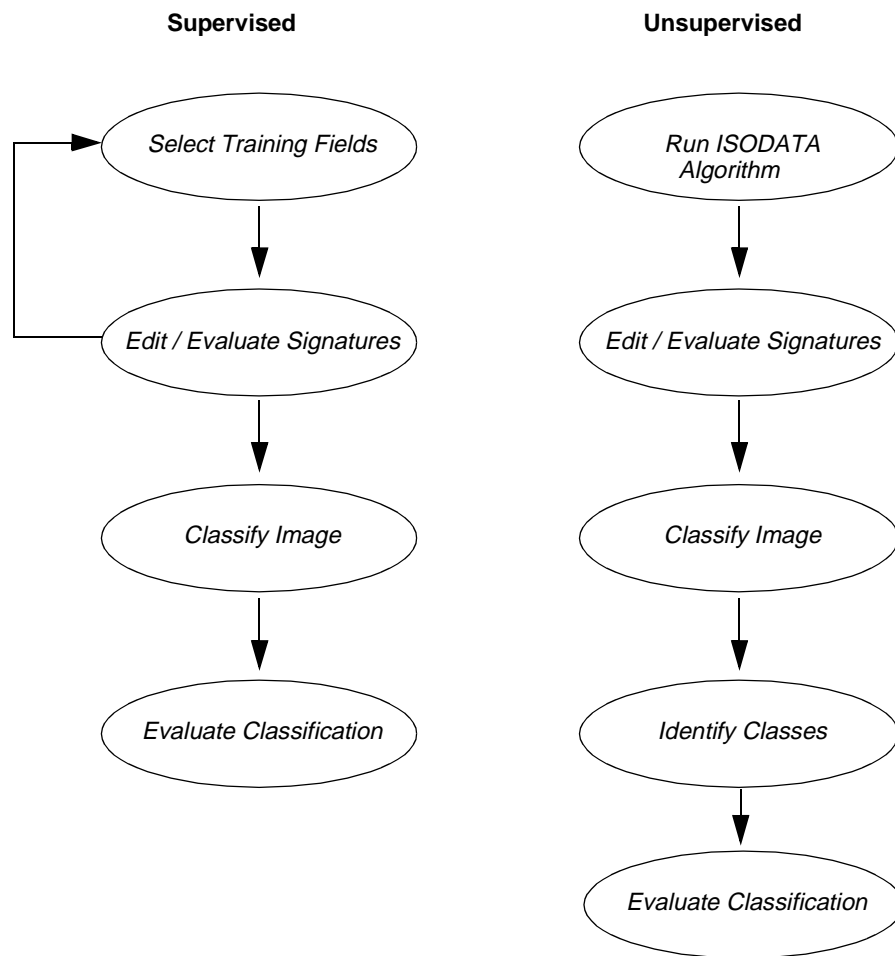

## Advanced Classification

This section describes the advanced classification functions.



*The tour guide, "CHAPTER 17: Advanced Classification", begins on page 455. The tour guide, "CHAPTER 18: IMAGINE Expert Classifier™", begins on page 503.*

## Signature Editor

The columns in the Signature Editor are discussed in the following table.

**Table A-1 Signature Editor**

<b>Class #</b>	Shows you the signature in the corresponding row.
<b>&gt; (Current Signature)</b>	The > symbol identifies the current signature.
<b>Signature Name</b>	Identifies the signature and is used as the class name in the output thematic raster layer. The default signature name is <b>CLASS &lt;number&gt;</b> . You can easily change the name by entering a new one in this column. The signature names must be unique.
<b>Color</b>	This is the color for the signature. It is used as the color for the class in the output thematic raster layer as well as other signature visualization functions, such as alarms, masking, ellipses, etc. The color can be changed from the third mouse button menu. If you select <b>Other</b> , the Color Chooser utility opens. Colors may also be set by selecting <b>Colors</b> from the <b>Edit</b> menu of the Signature Editor.
<b>Red, Green, and Blue</b>	These are the R, G, and B values used to create the color for the signature and class.
<b>Value</b>	This is the output classified class value for the signature. The output class value does not necessarily need to be the class number of the signature. This value should be a positive integer.
<b>Order</b>	This is the order to process the signatures for order-dependent processes, such as signature alarms and parallelepiped classifications.
<b>Count</b>	The number of pixels in the sample.
<b>Prob.</b>	This is the probability (a priori) or weight of the signature to be used for functions such as maximum likelihood and separability.
<b>P - Parametric</b>	Identifies whether or not the signature is parametric (i.e., a mean vector and covariance matrix exist).
<b>I - Inverse Covariance Matrix</b>	Identifies whether or not the covariance matrix can be inverted, which is necessary for such functions as maximum likelihood and divergence.
<b>H - Histogram</b>	Identifies whether or not histograms exist for the signature.
<b>A - Area of Interest</b>	Identifies whether or not the signature is associated with an area of interest in the image.
<b>FS - Feature Space</b>	Identifies whether or not the signature was created from a Feature Space image and indicates the layer pair used.



## Fourier Transform Editor

This section describes the menus and tools you use with the Fourier Transform Editor.



*The tour guide, "CHAPTER 10: Fourier Transform Editor", begins on page 215.*

## Fourier Editor Menu Bar

The Fourier Editor menu bar contains the following options.





**Table A-2 Fourier Editor Menu Bar**

File	Edit	Mask
New	Undo	Filters...
Open...	Filter Options...	Circular Mask...
Revert		Rectangular Mask...
Save		Wedge Mask...
Save All		
Save As...		
Inverse Transform...		
Clear		
Close		
Close All		

## Fourier Editor Tool Bar







The Fourier Editor tool bar contains the following icons.

**Table A-3 Fourier Editor Tool Bar**

<b>Open</b> 	Click to open an .fft layer.
<b>Create</b> 	Click to create a new Fourier Editor.
<b>Save</b> 	Click to save the currently displayed .fft layer.
<b>Clear</b> 	Click to clear the Fourier Editor.
<b>Select</b> 	Click to use the Select tool to get coordinate information from the .fft layer.



**Table A-3 Fourier Editor Tool Bar**

<p><b>Low-Pass Filter</b></p> 	<p>Click to perform a low-pass filtering operation. The window used is the one selected under <b>Edit   Filter Options...</b></p>
<p><b>High-Pass Filter</b></p> 	<p>Click to perform a high-pass filtering operation. The window used is the one selected under <b>Edit   Filter Options...</b></p>
<p><b>Circular Mask</b></p> 	<p>Click to use a circular mask. The window used is the one selected under <b>Edit   Filter Options...</b></p>
<p><b>Rectangular Mask</b></p> 	<p>Click to use a rectangular mask. The window used is the one selected under <b>Edit   Filter Options...</b></p>
<p><b>Wedge Mask</b></p> 	<p>Click to use a wedge mask. The window used is the one selected under <b>Edit   Filter Options...</b></p>
<p><b>Run</b></p> 	<p>Click to perform the Inverse Fourier Transform of the displayed layer.</p>

All operations performed using the tool bar icons can also be performed with the menu bar options. The mouse-driven tools are more interactive and may be easier to use. On the other hand, the menu options allow you to enter precise coordinates.

## Image Catalog

This section describes some of the menus and tools you work with using the Image Catalog.



*The tour guide, "CHAPTER 2: Image Catalog", begins on page 61.*

The ERDAS IMAGINE Image Catalog is used to record information about images for easy access and viewing.

Image Catalog functions are available via:

- the Image Catalog menu bar across the top of the window
- the Image Catalog tool bar below the Image Catalog menu bar
- a **Quick View** menu that opens when you right-hold the mouse cursor in the number column of the Image Catalog window

Some functionality is duplicated in these areas. For example, to open an existing catalog, you can:

- select **File | Open Catalog** from the Image Catalog menu bar

- click the Open Existing Catalog icon on the viewer tool bar



### Image Catalog Menu Bar

The menu bar across the top of the Image Catalog window has the following options:







**Table A-4 Image Catalog Menu Bar**

File	Edit	View
Open Catalog...	Catalog Layout...	Graphical Query Viewer...
New Catalog...	Catalog Image...	Form View...
Archive...	Manual Entry...	View Image (same Viewer)
Restore...	Delete Image	View Image (new Viewer)
Close		Image Info...
		Use Custom Layout...

### Image Catalog Tool Bar





The following icons are present in the Image Catalog tool bar:

**Table A-5 Image Catalog Tool Bar**

<b>Open</b> 	Click to open an existing catalog.
<b>Display Single</b> 	Click to display the selected image in a single Viewer. A new Viewer is created the first time an image is displayed. Thereafter, any new image displayed replaces the one in the original Viewer.
<b>Display Another</b> 	Click to display the selected image in another Viewer. A new Viewer is created for each image displayed.
<b>Info</b> 	Click to invoke the ImageInfo utility for the selected image.
<b>Add Image</b> 	Click to add one or more images to the catalog.
<b>Visual Query</b> 	Click to display the Image Catalog Graphical Viewer.



**Table A-5 Image Catalog Tool Bar (Continued)**

<b>Catalog Default</b> 	Click to display the catalog information for the selected image in a form view.
<b>Archive External</b> 	Click to archive the selected image to an external storage device.
<b>Archive Retrieval</b> 	Click to retrieve the selected image from the archive.
<b>Manual Insert</b> 	Click to manually insert a record into the current catalog.
<b>Delete</b> 	Click to delete the selected image(s) from the catalog. The actual image file on the disk is not deleted.

**Image Catalog CellArray**

The Image Catalog keeps a record of the data in each of the image files you have added. The default fields of data characteristics are listed in the following table:

**Table A-6 Image Catalog Data Characteristics**

Characteristic	Description
<b>Filename</b>	The name of the image file minus the path.
<b>Layers</b>	The number of layers in the file. For a thematic image, this is almost always 1. For continuous images, this is the number of spectral bands.
<b>Rows</b>	The number of rows of pixels in the image.
<b>Columns</b>	The number of columns of pixels in the image.
<b>Type</b>	Data can be thematic or athematic. Thematic data is GIS-type data where each pixel value has a categorical meaning. Athematic data is continuous data where the pixel value is a measure.
<b>Pixel</b>	The type of storage used for each pixel. See the <i>ERDAS Field Guide</i> for more information on pixel types.
<b>Projection</b>	The name of the projection that was used to georeference the image. If this cell is blank, then the image is not georeferenced and its footprint cannot be displayed in the Graphical Query viewer.
<b>Ulx</b>	The upper left map coordinate of the file. Based on the amount of projection information available for the image, this can be presented in latitude/longitude, map coordinates, or pixel coordinates. If map coordinates or pixel coordinates are displayed, then there is insufficient projection information available to display the image footprint in the Graphical Query viewer.
<b>Uly</b>	The upper left Y coordinate (see Ulx).



Table A-6 Image Catalog Data Characteristics (Continued)

Characteristic	Description
Lrx	The lower right X coordinate (see Ulx).
Lry	The lower right Y coordinate (see Uly).
Units	The units used for the Ulx, Uly, Lrx, and Lry coordinates. If <b>dd</b> does not display here, then there is insufficient information to convert the units to lat/lon.
Cellsize	The size in the horizontal direction for each pixel in the image.
CenterX	The lat/lon X coordinate of the center of the image.
CenterY	The lat/lon Y coordinate of the center of the image.
Catuser	The user name of the person who cataloged the image.
Logdate	The date on which the image was logged into the catalog
Status	Indicates whether an image is on-line, off-line, or archived. If an image is archived, then the Arc fields describe its archive information.
Arclabel	The label which identifies the particular archive media label.
Arcmedia	The type of media is identified, which is either tape_8mm or tape_9_track.
Arcuser	The user name of the person who archived the data.
Arcdate	The date on which the file was archived.
Arcsize	The number of bytes that the image occupies on the archive media.
Arcpos	The position of the archived file on the media.
Arcloc	The location of the archive media.
Path	The complete path that specifies the directory in which the image is found on-line.

### Adding Custom Maps

The maps which are displayed in the Image Catalog are Arc/Info coverages. The coverages are arranged in four groups:

- global
- regional
- subregional
- local

The intent of these arbitrary groupings is to group the coverages in a small scale (world) to a large scale (local) fashion.

1. Edit \$IMAGINE\_HOME/etc/catalog.cov or create it and put it in a directory in ERDAS\_ETC\_PATH.
2. Refer to the following information regarding syntax.



ArcInfo coverages to be used for Image Catalog backdrops are specified in the file `catalog.cov`, which is found in a directory in the `ERDAS_ETC_PATH` (the current directory, `$HOME/.imagine830`, or `$IMAGINE_HOME/etc`). In this file, you can specify a vector symbology (EVS) file to be used for the style of the coverages in that group. Within each group, you can specify global, regional, subregional, and local coverages to be displayed, depending on the level of detail appropriate for the area being viewed.

When using EVS files with Catalog backdrops:

- Attributes-based symbology in the EVS file is not used. All features are drawn with the default style defined in the EVS file.
- For the fill style specified in the EVS file for polygons, only the solid color and outline is used—the pattern fill is not used. If there is not a solid color or outline specified, the polygons are drawn in the preference style.
- For line styles specified in the EVS file for lines or polygon outlines, only the outer color and line width is used. No double lines or mark/gap patterns is used. The line width should be specified in paper units. As a rule of thumb, you can assume that 1 point = 1/72 inch is approximately 1 screen pixel.
- For symbol styles specified in the EVS file for points, the symbol, size, and color is used. The symbol size should be specified in paper units.

In the syntax of the `catalog.cov` file that follows, the conventions used are:

- **coverpath**—the name of the coverage file (including path).
- **evspath**—the optional name of the vector symbology file to be used for the style of the coverages in the group.
- **#**—the beginning of an optional comment line.
- **[...]**—a key word (including the square brackets).
- **|**—indicates that you should use one of the key words specified.
- **...**—indicates that there may be multiple coverages specified.

The file must contain at least one coverage name.

### Syntax 1: A single coverage

Enter the following commands for a single coverage:

```
#  
# The single coverage to be used as the backdrop at all times.  
#  
coverpath
```



For example:

```
#
# The single coverage to be used as the backdrop at all times. It is
# rendered using the catalog default area styles specified in the catalog
# preferences.

$IMAGINE_HOME/etc/backdrops/world
```

### Syntax 2: Detail-level coverages

Enter the following commands for detail-level coverages:

```
#
# The coverage to be used as the backdrop for global detail
#
coverpath
[endglobal]
#
# The coverages to be used as the backdrop for regional detail
#
coverpath
...
[endregional]
#
# The coverages to be used as the backdrop for subregional detail
#
coverpath
...
[endsubregional]
#
# The coverages to be used as the backdrop for local detail
#
coverpath
...
[endlocal]
```

For example:

```
#
# The area coverage to be used as the backdrop. Depending on the level of
# detail appropriate and the area being viewed, one coverage will be
# drawn. It is rendered using the catalog default area styles specified in
# the catalog preferences.
#
# The coverage to be used as the backdrop for global detail
#
$IMAGINE_HOME/etc/backdrops/world
[endglobal]
#
# The coverages to be used as part of the backdrop for regional detail
#
$IMAGINE_HOME/etc/backdrops/central
```



```

$IMAGINE_HOME/etc/backdrops/usa
$IMAGINE_HOME/etc/backdrops/africa
$IMAGINE_HOME/etc/backdrops/asia
$IMAGINE_HOME/etc/backdrops/australia
$IMAGINE_HOME/etc/backdrops/europe
$IMAGINE_HOME/etc/backdrops/southamerica
[endregional]
#
# The coverages to be used as part of the backdrop for local detail
#
[endlocal]

```

### Syntax 3: Multiple coverage types

Enter the following commands for multiple coverage types:

```

#
# A group of area, line, or point coverages to be used as part of the
# backdrop. Any number of these groups may be present in the file. Based
# on the appropriate level of detail and area being viewed, one coverage
# from each group will be drawn.
#
[areas | lines | points] evspath
#
# The coverage to be used as part of the backdrop for global detail
#
coverpath
[endglobal]
#
# The coverages to be used as part of the backdrop for regional detail
#
coverpath
...
[endregional]
#
# The coverages to be used as part of the backdrop for subregional detail
#
coverpath
...
[endsubregional]
#
# The coverages to be used as part of the backdrop for local detail
#
coverpath
...
[endlocal]
[endareas | endlines | endpoints]

```

For example:

```
#
# A group of area coverages to be used as part of the backdrop. Depending
# on the level of detail appropriate and the area being viewed, one
# coverage from this group will be drawn. It will be rendered using the
# default area styles specified in the catalog preferences.
#
[areas]
#
#The coverage to be used as part of the backdrop for global detail
#
$IMAGINE_HOME/etc/backdrops/world
[endglobal]
#
# The coverages to be used as part of the backdrop for regional detail
#
$IMAGINE_HOME/etc/backdrops/central
$IMAGINE_HOME/etc/backdrops/usa
$IMAGINE_HOME/etc/backdrops/africa
$IMAGINE_HOME/etc/backdrops/asia
$IMAGINE_HOME/etc/backdrops/australia
$IMAGINE_HOME/etc/backdrops/europe
$IMAGINE_HOME/etc/backdrops/southamerica
[endregional]
#
# The coverages to be used as part of the backdrop for subregional detail
#
$IMAGINE_HOME/etc/backdrops/midwest
$IMAGINE_HOME/etc/backdrops/northcentral
$IMAGINE_HOME/etc/backdrops/northeast
$IMAGINE_HOME/etc/backdrops/northwest
$IMAGINE_HOME/etc/backdrops/south
$IMAGINE_HOME/etc/backdrops/southcentral
$IMAGINE_HOME/etc/backdrops/southwest
[endsubregional]
#
# The coverages to be used as part of the backdrop for local detail
#
[endlocal]
[endareas]
#
# A single area coverage to be used as part of the backdrop at all times. It
# will be rendered with the default area (polygon) style in
# /data/backdrops/political.evs.
#
[areas] /data/backdrops/political.evs
/data/backdrops/political
[endareas]
#
# A single area coverage to be used as part of the backdrop at all times. It
#will be rendered with the default area (polygon) style in
```



```

# /data/backdrops/vegetation.evs.
#
[areas] /data/backdrops/vegetation.evs
/data/backdrops/vegetation
[endareas]
#
# A single area coverage to be used as part of the backdrop at all times. It
# will be rendered with the default area (polygon) style in
# /data/backdrops/drainage.evs.
#
[areas] /data/backdrops/drainage.evs
/data/backdrops/drainage
[endareas]
#
# A single line coverage to be used as part of the backdrop at all times. It
# will be rendered with the default line style in /data/backdrops/roads.evs.
#
[lines] /data/backdrops/roads.evs
/data/backdrops/roads
[endlines]
#
# A single point coverage to be used as part of the backdrop at all times. It
# will be rendered with the default point style in
# /data/backdrops/political.evs.
#
[points] /data/backdrops/political.evs
/data/backdrops/political
[endpoints]

```

## Image Interpreter

This section describes some of the functions and tools you use with the Image Interpreter.



*The tour guide, "CHAPTER 11: Image Interpreter", begins on page 239.*

## Image Interpreter Functions

The functions in Image Interpreter are briefly described in the following table:

**Table A-7 Image Interpreter Functions**

Function	Description
<b>SPATIAL ENHANCEMENT</b>	<b>These functions enhance the image using the values of individual and surrounding pixels.</b>
Convolution*	Uses a matrix to average small sets of pixels across an image.
Non-directional Edge	Averages the results from two orthogonal 1st-derivative edge detectors.
Focal Analysis	Allows you to perform one of several analyses on class values in an image file, using a process similar to convolution filtering.



Table A-7 Image Interpreter Functions (Continued)

Function	Description
Texture*	Defines texture as a quantitative characteristic in an image.
Adaptive Filter*	A filter that “adapts” the contrast stretch to the region of interest (the area within the moving window).
Statistical Filter*	Improves pixel values that fall outside the user-selected statistical range.
Resolution Merge	Merges imagery of different spatial resolutions.
Crisp	Sharpens the overall scene luminance without distorting the thematic content of the image.
<b>RADIOMETRIC ENHANCEMENT</b>	<b>These functions enhance the image using the values of individual pixels.</b>
LUT (Lookup Table) Stretch	Creates an output image that contains the data values as modified by a lookup table.
Histogram Equalization	Applies a nonlinear contrast stretch that redistributes pixel values so that there are approximately the same number of pixels with each value within a range.
Histogram Match	Mathematically determines a lookup table that converts the histogram of one image to resemble the histogram of another.
Brightness Inversion	Allows both linear and nonlinear reversal of the image intensity range.
Haze Reduction*	De-hazes Landsat 4 and 5 Thematic Mapper data and panchromatic data.
Noise Reduction*	Removes noise using an adaptive filter.
Destripe TM Data	Removes striping from a raw TM4 or TM5 data file.
<b>SPECTRAL ENHANCEMENT</b>	<b>These functions enhance the image by transforming the values of each pixel on a multiband basis.</b>
Principal Components	A method of compressing redundant data values into fewer bands, which are often more interpretable than the source data.
Inverse Principal Components	Performs an inverse principal components analysis.
Decorrelation Stretch	Applies a contrast stretch to the principal components of an image.
Tasseled Cap	Rotates the data structure axes to optimize data viewing for vegetation studies.
RGB to IHS	Transforms red, green, blue values to intensity, hue, saturation values.
IHS to RGB	Transforms intensity, hue, saturation values to red, green, blue values.
Indices	Commonly used mineral and vegetation ratios and indices.



**Table A-7 Image Interpreter Functions (Continued)**

Function	Description
Natural Color	Simulates natural color for multispectral data.
<b>HYPERSPECTRAL TOOLS</b>	<b>These functions enhance the image by helping to compensate for atmospheric contamination of the spectra.</b>
Automatic Relative Reflectance	Implements the following algorithms: Normalize, IAR Reflectance, and Rescale.
Automatic Log Residuals	Implements the following algorithms: Normalize, Log Residuals, and Rescale.
Normalize	Shifts each (pixel) spectrum to the same overall average brightness.
IAR Reflectance	Internal Average Relative Reflectance—Calculates a relative reflectance by dividing each spectrum (pixel) by the scene average spectrum.
Log Residuals	Corrects the image for atmospheric absorption, systemic instrumental variation, and illuminance differences between pixels.
Rescale	Maintains the 3-dimensional integrity of the data values.
Spectrum Average	Enables you to average any set of pixels you define; they do not need to be contiguous, and there is no limit on the number of pixels averaged.
Signal to Noise	Commonly used to evaluate the usefulness or validity of a particular band.
Mean per Pixel	Outputs a single band, regardless of the number of input bands, for sensor evaluation.
Spectral Profile	Enables you to view the reflectance spectrum of a designated pixel.
Spatial Profile	Enables you to view the reflectance(s) of the pixels along a user-defined polyline.
Surface Profile	Enables you to view any layer (band) or subset in the data cube as a relief surface.
Spectral Library	Laboratory measured reflectance spectra of reference minerals, often of high purity and defined particle size.
<b>FOURIER ANALYSIS</b>	<b>These functions enhance the image by applying a Fourier Transform to the data and enable you to edit a Fourier image.</b>
Fourier Transform*	A highly efficient version of the Discrete Fourier Transform (DFT).
Fourier Transform Editor*	Enables you to edit Fourier images using many interactive tools and filters.
Inverse Fourier Transform*	Computes the inverse two-dimensional Fast Fourier Transform of the spectrum stored.



Table A-7 Image Interpreter Functions (Continued)

Function	Description
Fourier Magnitude*	Converts the Fourier Transform image into an image file, which can be opened in the Viewer.
Periodic Noise Removal*	Automatically removes striping and other periodic noise from images.
Homomorphic Filter*	Enhances imagery using an illumination/reflectance model.
<b>TOPOGRAPHIC ANALYSIS</b>	<b>These functions provide tools for enhancing and analyzing topography in images.</b>
Slope	Allows you to calculate slope.
Aspect	Allows you to calculate aspect.
Level Slice	Divides the data values in a user-defined number of bins.
Shaded Relief*	Allows you to produce grayscale topographical relief images.
Painted Relief*	Allows you to produce colorized topographical images
Topographic Normalize	Allows you to reduce topographic effect in digital imagery by applying transformations such as the Lambertian or Non-Lambertian reflectance models.
Raster Contour*	Creates contour lines from an input elevation layer.
Surface	Generates a raster surface from various data types.
Viewshed*	Allows you to display hidden or visible areas within a set range.
Anaglyph*	Generates a color anaglyph image from a raster image and a DEM image.
DEM Height Converter*	Converts elevation data in a DEM from one set of units to another set of units.
<b>GIS ANALYSIS</b>	<b>These functions provide functions for simple GIS analysis.</b>
Neighborhood	Evaluates the region surrounding the pixel of interest.
Clump	Identifies clumps, which are contiguous groups of pixels in one thematic class.
Sieve	Filters clumps of specific sizes.
Eliminate	Eliminates small areas or classes and fills them based on the values of neighboring pixels.
Perimeter	Finds the perimeter of each clump. Use only on a file which is the output of the clump analysis.
Search	Performs a proximity analysis on an input thematic layer and creates an output thematic layer. The resulting output contains new class values that are assigned based on proximity to user-specified input class values.
Index	Creates a composite image file by adding together the class values of two to four “weighted” input raster files.



**Table A-7 Image Interpreter Functions (Continued)**

Function	Description
Overlay	Creates a composite output image file by combining two to four input image files based on the minimum or maximum values of the input files.
Matrix	Analyzes two input raster files and produces a new file. The new file contains class values that indicate how the class values from the original files overlap.
Recode	Assigns a new class value number to any or all classes of an existing image file, creating an output file using the new class numbers.
Summary*	Produces cross-tabulation statistics that compare class value areas between two thematic files.
Zonal Attributes	Computes statistics about a raster layer for each polygon in a polygon coverage.
<b>UTILITIES</b>	<b>These functions provide basic image processing utilities.</b>
Change Detection	Allows you to compute and highlight the differences between two images.
Functions	Allows you to use a specific Spatial Modeler function for processing.
Operators	Provides six mathematical operations: addition (+), subtraction (-), division (/), multiplication (*), square root (POWER), and modulus (MOD).
RGB Clustering*	Applies a simple classification and data compression technique to 24-bit data.
Adv. RGB Clustering	Performs RGB clustering on one or more input image files.
Layer Stack	Allows you to rearrange or remove layers of data in a file.
Subset*	Allows you to copy a selected portion, or subset, of an input data file into an output data file.
Create File	Allows you to create a file of specified size, data type, etc.
Rescale	Allows ERDAS IMAGINE to utilize any data type as input and output.
Mask	Uses a image file to select (mask) specific areas from a corresponding raster file and use those areas to create one or more new files. The areas to mask are selected by class value.
Degrade*	Enables you to reduce the resolution of an image.
Replace Bad Lines	Replaces bad lines with the line above, below, or an average.
Vector to Raster	Allows you to convert a vector coverage to a raster coverage.
Reproject*	Allows you to reproject or transform raster image data from one map projection to another.

\* Indicates functions that are *not* graphical models.



**Import/Export**

This section describes the menu and tools used with the Import/Export function.



*The tour guide, "CHAPTER 8: Import/Export", begins on page 161*

**Data View Menu Bar**

The Data View menu bar contains access to these functions:





**Table A-8 Data View Menu Bar**

File	Edit	Help
New	Copy	Help for Data View
Open File...	Rewind	
Open Tape...	Define Data Structure...	
Save Tape/File Structure		
Save Record		
Close		
Close All		

**Data View Tool Bar**

The Data View tool bar contains icons that provide quick access to these functions:

**Table A-9 Data View Tool Bar**

<b>Open</b> 	Open a File. This allows you to select the file to view in the Data Viewer dialog.
<b>Data View</b> 	Start a new Data View window. This allows you to open an additional Data Viewer dialog without closing the current Data Viewer dialog.
<b>Copy</b> 	Copy selected text from data field or Tape Structure to a paste buffer. Text can be pasted in a Text Editor document.
<b>Rewind</b> 	Rewind to the beginning of tape.

## ImageInfo Menu Bar

The ImageInfo menu bar contains access to these functions:

**Table A-10 ImageInfo Menu Bar**





File	Edit	View	Help
Open	Change Layer Name	Histogram	Help for Image Info
New	Change Layer Type	Pixels	
Print Options	Delete Current Layer		
Print	Compute Statistics		
Close	Compute Pyramid Layers		
Close All	Delete Pyramid Layers		
	Add/Change Map Info		
	Delete Map Info		
	Add/Change Projection		
	Delete Projection		
	Delete Calibration		
	Raster Attribute Editor		

Keyboard shortcuts to access these menu options are indicated by underlines. For example, to access the **File** menu from the keyboard, press the Meta key and f. Once the **File** menu is displayed, use the arrow keys to select an option and then press the Return or Enter key.



## ImageInfo Tool Bar

The ImageInfo tool bar contains icons that provide quick access to these functions:

**Table A-11 ImageInfo Tool Bar**

<b>Open</b> 	Open a File. This allows you to select the image file containing the information you want to display in the ImageInfo dialog.
<b>ImageInfo</b> 	Start a new ImageInfo dialog. This allows you to open an additional ImageInfo dialog to display information for another image file without closing the current ImageInfo dialog.
<b>Print</b> 	Print the image information currently displayed.
<b>Calculate</b> 	Compute statistics for the file based on the current image information. This is useful if you make changes in the dialog and need to recompute the statistics based on these changes.

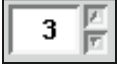
**Table A-11 ImageInfo Tool Bar (Continued)**

<p><b>Histogram</b></p> 	<p>Display the histogram for the current layer.</p>
<p><b>Layer by Number</b></p> 	<p>Select a layer by number. Edit the displayed number or use the nudgers to increment or decrement.</p>
<p><b>Layer by Name</b></p> 	<p>Select a layer by name. Click to display a popup list of names.</p>

---

**Map Composer**

This section describes some things to consider when using the Map Composer.



*The tour guide, "CHAPTER 3: Map Composer", begins on page 73.*

When you create a map or a presentation graphic using Map Composer, you need to have a plan or a blueprint to follow. You must know the output size, annotation required, etc. This information determines the steps needed to create and output your map in ERDAS IMAGINE.

For this exercise, the specifications of the map are planned for you, but in the future, you need to do this groundwork before starting your composition. The map you create in this tutorial resembles the following illustration:



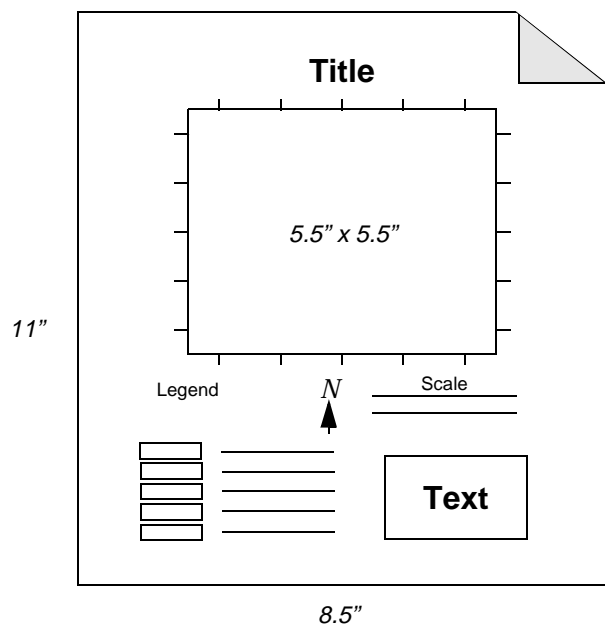

In the drawing, it is indicated that the map should have tick marks, scale bars, a north arrow, legend, title, and other descriptive text.

Maps are created and displayed in Map Composer viewers, appearing similar to the following example.

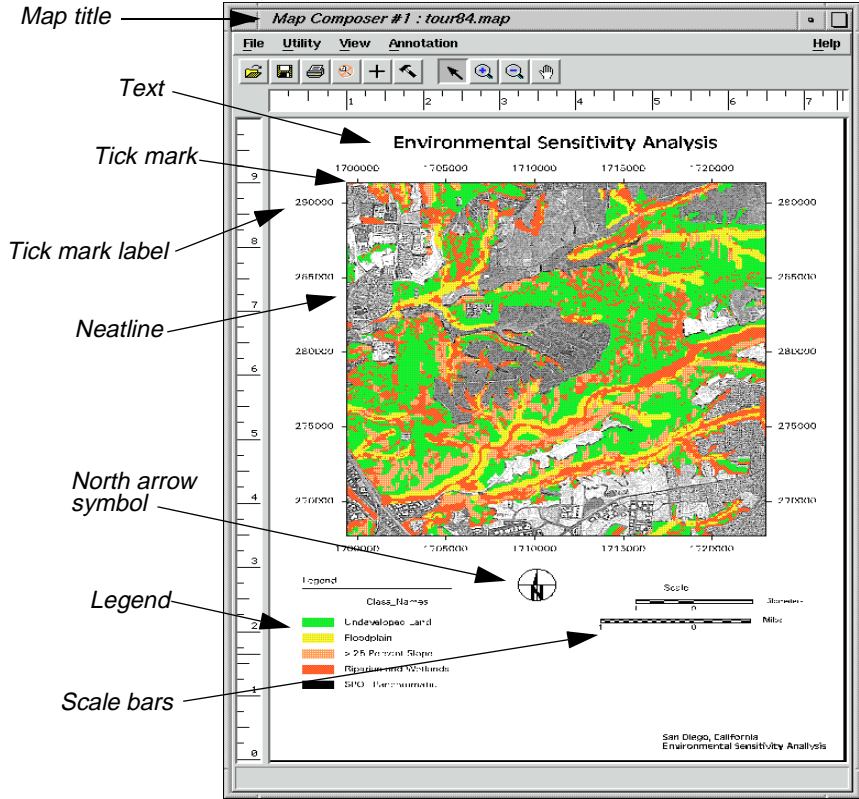

**Map Composer Menu Bar**

The menu bar across the top of the Map Composer viewer has the following options:

**Table A-12 Map Composer Menu Bar**

<b>File</b>	<b>Utility</b>	<b>View</b>	<b>Annotation</b>
New...	Inquire Cursor...	Arrange Layers ...	Tools ...
Open...	Inquire Box...	Zoom	Undo
Save	Inquire Color...	Scale	Cut
Print...	Inquire Shape...	Background Color...	Copy
Close	Inquire Home	Map Size...	Paste
		Status Bar	Group
		Scroll Bars	Ungroup
		Menu Bar	Reshape
		Tool Bar	Raise
		Borders	Lower
		Layout Mode	Distribute
			Flip
			Align Object North
			Alignment...
			Element Properties...
			Styles...
			Attributes





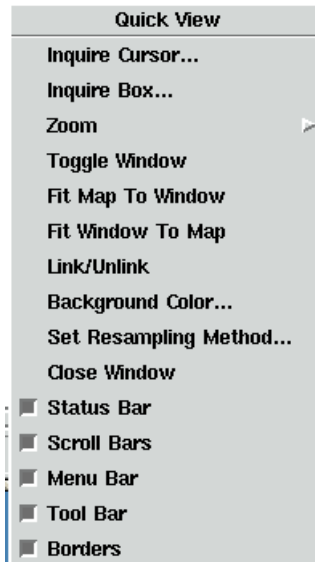



There is also another menu of options, called the **Quick View** menu, that is available when you right-hold while your cursor is in the Map Composer viewer.





## Map Composer Tool Bar

The Map Composer tool bar includes the following icons:

**Table A-13 Map Composer Tool Bar**

<b>Open</b> 	Click to open an existing map composition.
<b>Save</b> 	Click to save the map composition.
<b>Print</b> 	Click to print the map composition.
<b>Reset Zoom</b> 	Click to reset the zoom to the default.
<b>Inquire Cursor</b> 	Click to start or update the Inquire cursor.
<b>Tools</b> 	Click to bring up the Annotation tool palette.
<b>Select</b> 	Click to select and reposition objects in the map.

**Table A-13 Map Composer Tool Bar**

<b>Zoom In</b> 	Click to zoom in by two.
<b>Zoom Out</b> 	Click to zoom out by two.
<b>Roam</b> 	Click to roam in the map composition.





**Annotation Tool Palette**

The Annotation tools are available from the Viewer menu bar or from the Map Composer menu bar. These tools allow you to place rectangles, squares, polygons, lines, circles, scale bars, legends, map frames, grid lines, tick marks, text, and more in an annotation layer or in a map composition.













When you create a new map in Map Composer, the tools are automatically displayed for you. To display the tools at other times, select **Annotation | Tools** from the Map Composer menu bar or click the Tool icon in the Map Composer tool bar. Your tool palette may look different from the one pictured on page 75, depending upon how the **Tool Palette Size** and the **Combine Tools and Commands** preferences are set in the Viewer category.

The functions of each of the major icons in the Annotation tool palette are described in the following table:

**Table A-14 Annotation Tool Palette**

<b>Select</b> 	The Select tool is used to select and reposition objects in the map. Click on an object to select it. Shift-click to add to a selection.
<b>Marquee</b> 	Use the Marquee tool to select multiple elements. This is also a useful tool when selecting very small elements.
<b>Rectangle</b> 	The Rectangle tool is used to draw filled or unfilled rectangles and squares. Press the shift key while drawing to create a perfect square.
<b>Ellipse</b> 	Use the Ellipse tool to draw filled or unfilled ellipses and circles. Press the shift key while drawing to create a perfect circle.
<b>Polygon</b> 	Draw filled or unfilled polygons with as many vertices as needed.

**Table A-14 Annotation Tool Palette (Continued)**

<p><b>Polyline</b></p> 	<p>Draw polylines with as many vertices as needed.</p>
<p><b>Arc</b></p> 	<p>Draw elliptical arcs. Press the shift key while drawing to create a perfectly circular arc.</p>
<p><b>Symbol</b></p> 	<p>Use the Symbol tool to place symbols such as north arrows.</p>
<p><b>Text</b></p> 	<p>Use the Annotation Text tool to indicate where to place text. Text strings are typed in another dialog.</p>
<p><b>Region Grow</b></p> 	<p>Use the Region Growing tool to select a single pixel from which a polygonal area “grows” based on the parameters set in the Region Growing Properties dialog.</p>
<p><b>Map Frame</b></p> 	<p>The Map Frame tool is used in a map composition for the placement and definition of images.</p>
<p><b>Select Map Frame</b></p> 	<p>Use the Select Map Frame tool in a Map Composer viewer only to select a map frame. Use this tool when you need to edit or reposition a map frame.</p>
<p><b>Grid/Tick</b></p> 	<p>Use the Grid/Tick tool in a map composition or a Viewer to add grid lines, tick marks, and a neatline.</p>
<p><b>Scale Bar</b></p> 	<p>Use the Scale Bar tool in a map composition to add a scale bar(s) to a composition.</p>
<p><b>Legend</b></p> 	<p>Use the Legend tool to add a legend to a map composition.</p>
<p><b>Help</b></p> 	<p>Click to see the On-Line Help document for Annotation tools.</p>
<p><b>Lock</b></p> 	<p>Use the Lock tool to lock and unlock the currently selected tool for repeated use.</p>
<p><b>Close</b></p>	<p>Click to close the tool palette.</p>

## Ungroup Elements in Map Composer

Situations may arise in which you need to edit one or more individual elements of a complex object (like the one you have just created). Since grids and ticks are groups of elements, they can be ungrouped and the elements edited individually or copied, cut, or pasted.



---

*Because of the large number of elements composing such an object, engaging in this level of editing can be a time-consuming process.*

### Preparation

The set of elements that you want to ungroup must be selected.

1. In the Map Composer menu bar, select **Annotation | Ungroup** to ungroup the selected elements.

Selection boxes are drawn around each component that makes up the group.

*NOTE: You may need to use the Ungroup function several times consecutively in order to achieve the desired separation.*

2. In the Map Composer viewer, click outside any of the selection boxes to deselect everything.
3. Select any one part of the original group by clicking on it.

You can now edit, cut, paste, copy, etc.

### Regrouping Elements

4. To regroup elements, select all elements you want included in the group by clicking the first element, then Shift-clicking the others until all the elements you want included in the group are selected. Then select **Annotation | Group** from the Map Composer menu bar.

*NOTE: You can also select multiple elements at once using the Marquee tool in the Annotation tool palette.*

---

## Mosaic

This section describes some of the menus and tools you work with using the Mosaic tool.



---

*The tour guide, "CHAPTER 14: Mosaic", starts on page 291.*

**Mosaic Tool Menu Bar**

The Mosaic Tool menu bar contains access to these functions:

**Table A-15 Mosaic Tool Menu Bar**







File	Edit	Process
New...	Image List...	Run Mosaic...
Open...	Add Images...	Preview Mosaic
Save	Delete Image(s)	
Save As...	Image Matching...	
Annotation...	Intersection List...	
Close	Set Overlap Function...	
Close All	Output List...	
	Output Options...	
	Delete Outputs	

Some of the functionality of these menu items is duplicated in the tool bar, as explained in the next section.

**Mosaic Tool Tool Bar**

The Mosaic Tool tool bar contains these icons:

**Table A-16 Mosaic Tool Tool Bar**

<b>Add Images</b> 	Click to display the Add Images for Mosaic dialog, which allows you to add images to the Mosaic Tool viewer.
<b>Input</b> 	Allows you to set the mode for input images.
<b>Intersection</b> 	Allows you to preview the stitched image of the files in a Viewer window.
<b>Output</b> 	Allows you to set the mode for output images.
<b>Reset Canvas</b> 	Allows you to change the canvas size in the Mosaic Tool viewer so that it fits the displayed image.
<b>Scale Canvas</b> 	Allows you to scale the canvas in the Mosaic Tool viewer to fit selected objects.
<b>Select</b> 	Allows you to select a single point in the displayed image for querying.



**Table A-16 Mosaic Tool Tool Bar (Continued)**

























<p><b>Query Select</b></p> 	<p>Allows you to select an area of the displayed image for querying.</p>
<p><b>Zoom In</b></p> 	<p>Allows you to zoom a selected portion of the image in by 2.</p>
<p><b>Zoom Out</b></p> 	<p>Allows you to zoom a selected portion of the image out by 2.</p>
<p><b>Select Area for Zoom</b></p> 	<p>A tool which allows you to draw a box in the image to select an area to zoom in on.</p>
<p><b>Roam</b></p> 	<p>A tool which allows you to view different parts of the image by dragging to manipulate the image in the canvas.</p>
<p><b>Image List</b></p> 	<p>Depending upon which mode you are in, click to display the Add Images for Mosaic dialog, the Mosaic Intersection List, or the Mosaic Output List.</p>
<p><b>Image Resample</b></p> 	<p>Click to display the Image Resample Options dialog. This tool is available when you are using the Input mode.</p>
<p><b>Image Matching</b></p> 	<p>Allows you to perform contrast matching on files in the file list. Although this step is not required, it can help to reduce the spectral differences among the images.</p>
<p><b>Send to Top</b></p> 	<p>Click to send selected image(s) to the top in the stacking order. This tool is available when you are using the Input mode.</p>
<p><b>Send Up One</b></p> 	<p>Click to send selected image(s) up one in the stacking order. This tool is available when you are using the Input mode.</p>
<p><b>Send to Bottom</b></p> 	<p>Click to send selected image(s) to the bottom in the stacking order. This tool is available when you are using the Input mode.</p>
<p><b>Send Down One</b></p> 	<p>Click to send selected image(s) down one in the stacking order. This tool is available when you are using the Input mode.</p>
<p><b>Reverse Order</b></p> 	<p>Click to reverse the order of selected image(s) in the stacking order. This tool is available when you are using the Input mode.</p>

Table A-16 Mosaic Tool Tool Bar (Continued)

<b>Next Intersection</b> 	Click to select the next intersection. This tool is available when you are using the Intersection mode.
<b>Previous Intersection</b> 	Click to select the previous intersection. This tool is available when you are using the Intersection mode.
<b>Function</b> 	Click to display the Overlap Function dialog. This tool is available when you are using the Intersection mode.
<b>Default Cutline</b> 	Click to set default cutlines for intersections. This tool is available when you are using the Intersection mode.
<b>AOI Cutline</b> 	Click to set user-defined AOI cutlines for intersections. This tool is available when you are using the Intersection mode.
<b>Toggle Cutline</b> 	Click to toggle the cutline application (keep other side). This tool is available when you are using the Intersection mode.
<b>Delete Cutline</b> 	Click to delete the cutlines for intersections. This tool is available when you are using the Intersection mode.
<b>Cutline Selection viewer</b> 	Click to open the Cutline Selection viewer. This tool is available when you are using the Intersection mode.
<b>Auto Cutline</b> 	Click to access the Cutline Selection viewer Auto mode. This tool is available when you are using the Intersection mode.
<b>Output Image</b> 	Click to set the Output Image Options dialog. This tool is available when you are using the Output mode.
<b>Run Mosaic</b> 	Click to run the mosaicking process. This tool is available when you are using the Output mode.
<b>Preview Mosaic</b> 	Click to generate and view a review of the results of the mosaicking process. The preview will open in a temporary Viewer. This tool is available when you are using the Output mode.

The icons in the tool bar provide quick access to the most frequently used mosaic functions.



The tour guides, "CHAPTER 6: Polynomial Rectification" and "CHAPTER 12: Orthorectification", start on page 135 and page 267, respectively.

## Input and Reference Images

Two types of GCPs are:

- input GCPs, which are in the coordinate system of the source image and are digitized in the Viewer from which you started the GCP Tool (the source Viewer).
- reference GCPs, which are the known reference coordinates of the corresponding input GCPs.

The input Viewer always opens the data *to be rectified* to the reference coordinate system. In this instance, the input image is **tmAtlanta.img** and the reference image is **panAtlanta.img**.

With the GCP Tool and its Automatic Transform Calculation mode turned on, you can interactively edit GCPs and calculate and edit the transformation matrix until the RMS error is acceptably low.

The residuals, RMS error, Contribution and Match fields in the GCP Tool are not editable. These automatically update as you edit the GCPs and recalculate the transformation (when the Automatic Transform Calculation mode is turned on).

The GCP Tool looks like the following:

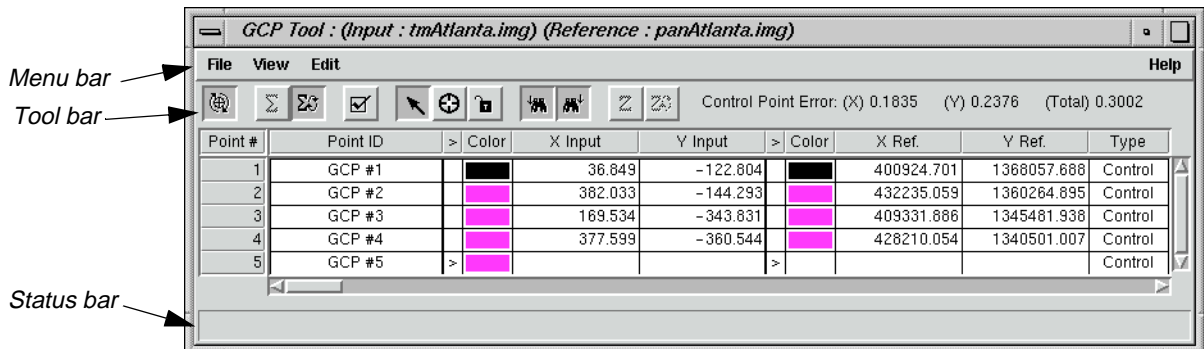



GCP Tool Menu Bar

The menu bar across the top of the GCP Tool has the following options:







**Table A-17 GCP Tool Menu Bar**

File	View	Edit
Load Input...	View Only Selected GCPs	Set Point Type
Save Input	Show Selected GCP in Table	Reset Reference Source...
Save Input As...	Arrange Frames on Screen	Reference Map Projection...
Load Reference...	Tools...	Point Prediction...
Save Reference	Start Chip Viewer	Point Matching...
Save Reference As...		
Close		

*NOTE: Not all options are always available. Invalid options appear shaded.*





GCP Tool Bar

**Table A-18 GCP Tool Bar**

<b>Toggle</b> 	Click to toggle the fully automatic GCP editing mode.
<b>Calculate</b> 	Click to solve the geometric model with GCPs.
<b>Automatic</b> 	Click to set automatic transformation calculation. When this is set, the transformation is updated automatically as points change.
<b>Compute Error</b> 	Click to compute the error for checkpoints.
<b>Select</b> 	Click to activate the GCP selection tool. This tool allows you to select a GCP symbol displayed in a viewer by clicking on it.  This is the default tool.
<b>Create</b> 	Click to create a GCP in a Viewer.
<b>Lock</b> 	Click to lock and unlock the current tool for repeated use.



**Table A-18 GCP Tool Bar**

<p><b>Find in Input</b></p> 	<p>Click to locate the selected point in the input image. This option finds the point selected in the GCP Tool CellArray and highlights it in the input Viewer.</p>
<p><b>Find in Reference</b></p> 	<p>Click to locate the selected point in the reference image. This option finds the point selected in the GCP Tool CellArray and highlights it in the reference Viewer.</p>
<p><b>Z Value</b></p> 	<p>Click to automatically update Z values based on an identified elevation source.</p>
<p><b>Automatic Z Value</b></p> 	<p>Click to automatically update Z Values.</p>

**Record Ground Control Points**

A ground control point (GCP) is a location within an image for which the map coordinates are known. To be useful in rectification, the coordinates of a GCP must be known in the system to which the data are being rectified. GCPs can be recorded from a Viewer, digitizing tablet, or from an ASCII file.

**Corresponding GCPs**

Any ERDAS IMAGINE image can have one GCP set associated with it. The GCP set is stored in the data file along with the raster layers. If a GCP set exists for the top raster layer that is shown in the Viewer, then those GCPs are shown when you bring up the GCP Tool.

In the CellArray of GCP data, located in the GCP Tool, one column shows the point ID of each GCP. The point ID is a name given to GCPs in separate files that represent the same geographic location. Such GCPs are called corresponding GCPs.

A default ID string is provided (something like “GCP #1”), but you can enter your own unique ID strings to set up corresponding GCPs as needed. Even though only one set of GCPs is associated with a raster layer, one GCP layer can include GCPs for a number of rectifications by changing the point IDs for different sets of corresponding GCPs.

**GCPs in ERDAS IMAGINE Files**

GCPs that are digitized in a Viewer are stored with the raster data that are listed in the Viewer. However, GCPs can also be recorded from a digitizing tablet or straight from the keyboard. In these cases, they are stored alone in ERDAS IMAGINE files with the extension .gcc.

**Spatial Modeler**

This section describes the menus and tools you use with Spatial Modeler.



*The tour guide, "CHAPTER 16: Spatial Modeler", starts on page 341.*

**About Model Maker**

A model is a set of instructions for performing geoprocessing operations. Models can be created graphically with Model Maker or in text form. Modeling with Model Maker is similar to drawing a flow chart.

Model Maker is not only very easy to use, it is also powerful—providing access to over 200 functions and operators in 24 categories, including:

- analysis
- arithmetic
- bitwise
- boolean
- color
- conditional
- data generation
- descriptor
- distance
- exponential
- focal (scan)
- focal apply opts
- focal use opts
- global
- matrix
- other
- relational
- size
- stack statistical
- statistical
- string
- surface
- trigonometric
- zonal

You can manipulate raster layers, vector layers, matrices, tables, and scalars. In doing so, you can create your own algorithms to best address the goals of your project and data set.





All of the data used in this tour guide are in the <IMAGINE\_HOME>/examples directory. Replace <IMAGINE\_HOME> with the directory where IMAGINE is installed on your system.

## Creating Graphical Models

All of the graphical models you create in Model Maker have the same basic structure: input, function, output. The number of inputs, functions, and outputs can vary, but the overall form remains constant. All components must be connected to one another before the model can be run.

In the following graphic, the model on the left is the most basic form. The model on the right illustrates a more complex model, but as you can see, it retains the same input/function/output flow.

Basic Model

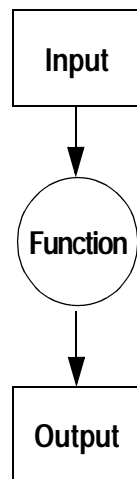

Complex Model

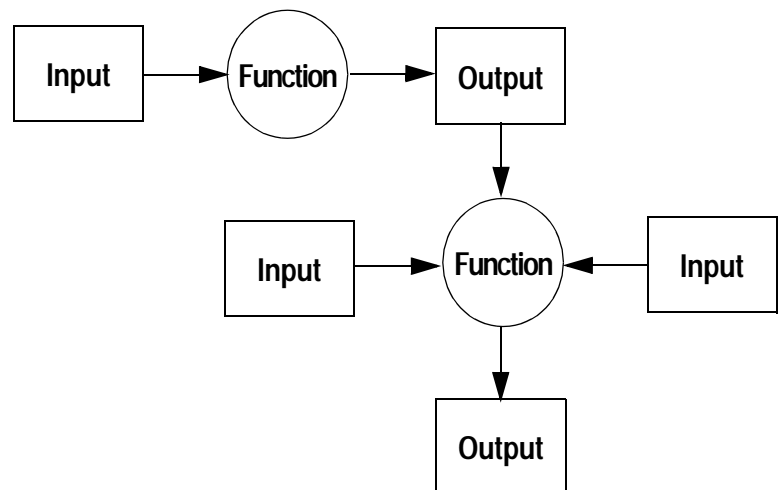

## Defining Model Files and Parameters

Once you have placed graphics in the Model Maker viewer, you must define what each of those graphics represents. A question mark underneath a graphic tells you that the element is not yet defined. All elements must be defined before the model can be run.

Double-click on a graphic (or click on it once and select **Edit | Properties**) to bring up a dialog in which you enter file names, functions, or other specifications. For example, when you double-click on the raster graphic, the Raster dialog opens.

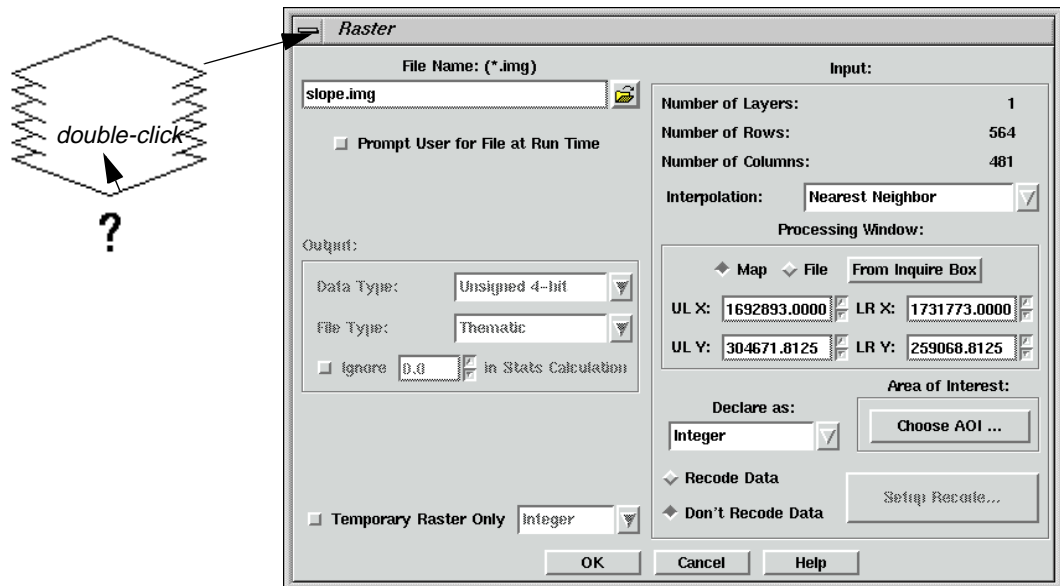

**Solving Problems**

When you use Model Maker to solve real-world problems, such as site selection, land use planning, resource management, etc., you perform these basic steps:

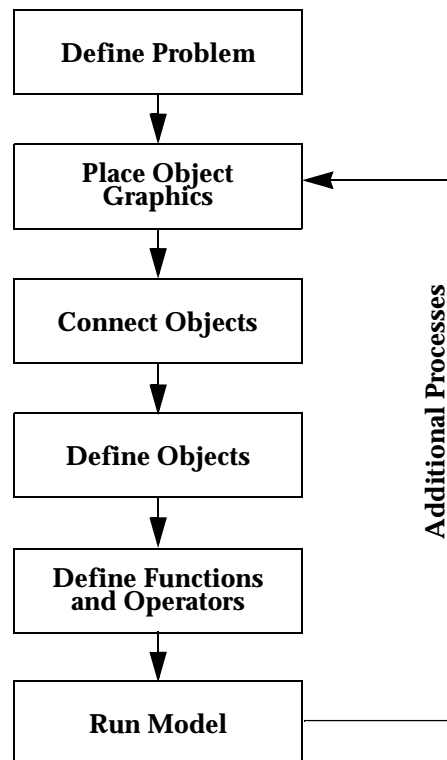

The order you use may vary from the linear method outlined here, but all of these steps must be completed to create a syntactically correct model.

The example that follows illustrates these steps in detail.

### Define Problem

Before you can begin creating a model, you should have a desired goal in mind. Once you know what your final product should be, you can work back from there to determine what inputs you need and what functions can be applied to those inputs.

In this example, envision yourself as an environmental planner in Del Mar, California. You want to identify the most environmentally sensitive areas in the region so that they can be protected. To give these sensitive areas perspective, you can overlay them onto a satellite image.

### Determine Input Data

Based on the goal of this project, you first need a satellite image of the area and thematic layers that are used for determining environmental sensitivity.

#### *What kind of satellite data should you use?*

Because the satellite image is used as a reference, you use SPOT panchromatic data. The 10 meter resolution provides good spatial detail. In addition, the black-and-white image does not detract from the colors in the overlaid sensitivity analysis.

#### *What thematic layers are required?*

Environmental sensitivity in this study is based on the following three factors:

- flood plain—low lying areas, or flood plains, are not suitable for development due to their fragile and changeable condition. This layer was generated by identifying buffers around first- through fourth-order streams to approximate the actual flood plain.
- land cover—a land cover classification of the area was produced using Landsat Thematic Mapper data. The Riparian and Wetlands classes are the most environmentally sensitive land cover types.
- slope—slopes greater than 25 percent should be protected because of erosion potential.

### Determine Functions

This model incorporates three phases. Each phase includes a simple model, with inputs, a function, and an output. The output layers derived from the first two phases are the inputs in the last phase to create the final product. These three steps are combined into one graphical model.

The three phases are:

- Create sensitivity layer—the first phase of the model is to combine the three thematic layers into one sensitivity layer.
- Enhance SPOT data—to increase the sharpness and contrast of the SPOT layer, you run a convolution kernel over it.
- Combine sensitivity layer with SPOT data—create the final product by combining the thematic sensitivity layer and the SPOT satellite data.

Model Maker Viewer and Tool Palette

Following is a sample Model Maker viewer and tool palette.

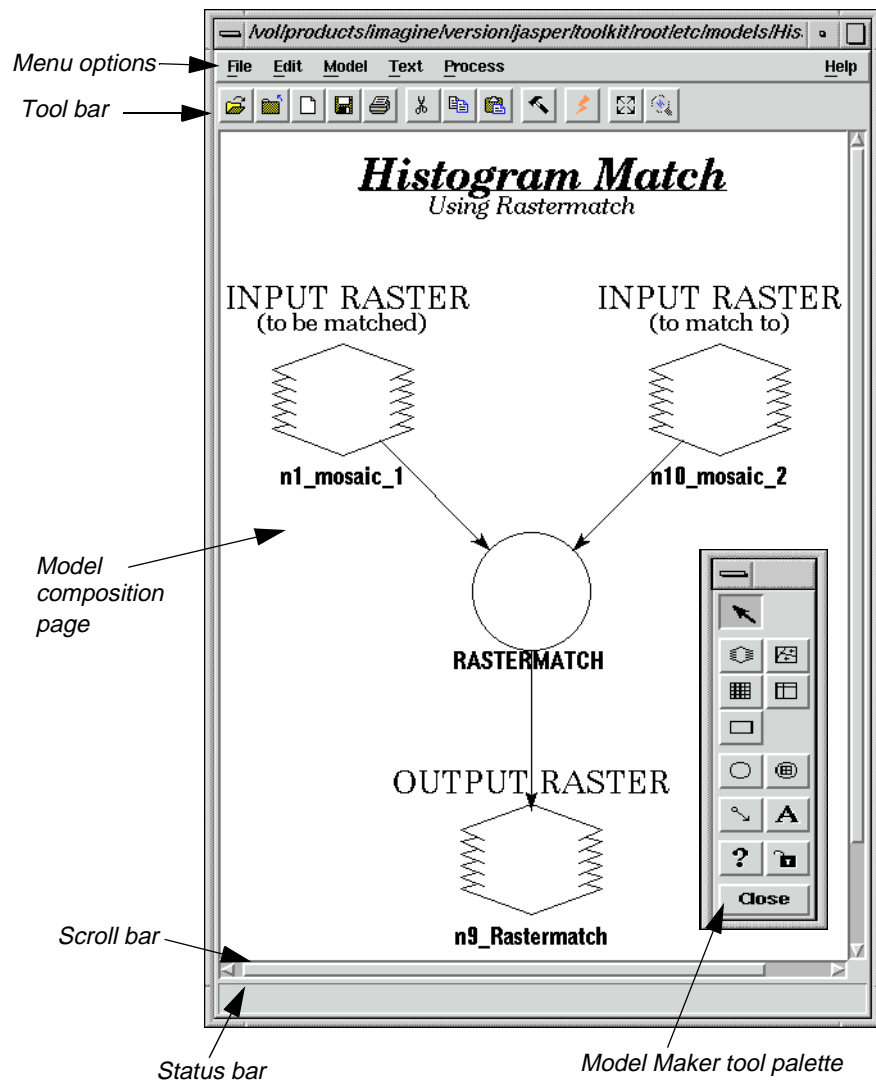

### Model Maker Viewer Menu Bar

The menu bar across the top of the Model Maker viewer has the following options:





**Table A-19 Model Maker Viewer Menu Bar**

File	Edit	Model	Text	Process	Help
New	Cut	Set Cell Size ...	Font	Run	Help for ModelMaker
Open ...	Copy	Set Window...	Size	Generate Script...	Help For This Model
Close	Paste	Set Projection...	Style		Imagine Version
Save	Clear	Area of Interest ...			
Save As ...	Select All	Snap to Grid			
Revert to Saved	Invert Selection	Overview			
Page Setup ...	Properties ...	Optimize			
Show Page Breaks	Tools ...				
Print ...					
Close All					

### Model Maker Viewer Tool Bar







All viewers in ERDAS IMAGINE contain tool bars. These tool bars allow you to access commonly used functions quickly. Simply click on the icon to perform that action. The Model Maker viewer tool bar includes the following icons:

**Table A-20 Model Maker Viewer Tool Bar**

<b>Open</b> 	Click to open an existing graphical model.
<b>Close</b> 	Click to close the model.
<b>New Window</b> 	Click to open a new Model Maker viewer.
<b>Save</b> 	Click to save the model to a file.
<b>Print</b> 	Click to print the model.





**Table A-20 Model Maker Viewer Tool Bar**

<p><b>Cut</b></p> 	<p>Click to cut selected object(s) from the model.</p>
<p><b>Copy</b></p> 	<p>Click to copy the selected object(s) to the paste buffer.</p>
<p><b>Paste</b></p> 	<p>Click to paste the buffer contents into the model. The option should be used only after using the Copy option.</p>
<p><b>Tools</b></p> 	<p>Click to bring up the Model Maker tool palette.</p>
<p><b>Run</b></p> 	<p>Click to run the model. This icon is not active until the model is defined completely.</p>
<p><b>Overview</b></p> 	<p>Click to fit the entire model in the current window. This is useful for graphically arranging your model. Annotation elements are not moved with other elements.</p> <p>NOTE: Since Model Maker does not use scalable fonts, annotation is not displayed in this format. However, the annotation is not lost; it redisplayes when the model is enlarged to full size.</p>
<p><b>Zoom In</b></p> 	<p>Click to zoom back to full resolution, and the image is centered about the point clicked.</p>









**Model Maker Tool Palette**

The Model Maker tools allow you to place input and output objects, define functions, specify criteria, connect components, and annotate models. Click on a tool to use it.

**Table A-21 Model Maker Tool Palette**

<p><b>Select</b></p> 	<p>Used to select and reposition objects in a model. Simply click on a graphic in the Model Maker viewer to select it. Middle-click or Shift-click to add to a selection. Double-click on an graphic in the Model Maker viewer to bring up that tool's definition dialog. Drag and draw a rectangle over several objects to select them as a group.</p>
<p><b>Raster</b></p> 	<p>Used to place an input or output raster object in a model, such as satellite data or thematic layers. The raster is undefined until you double-click on the Raster graphic in the Model Maker viewer to open the Raster dialog.</p>
<p><b>Vector</b></p> 	<p>Used to place an input vector object in a model. The vector layer is undefined until you double-click on the Vector graphic in the Model Maker viewer to bring up the Vector dialog.</p>

**Table A-21 Model Maker Tool Palette (Continued)**

<p><b>Matrix</b></p> 	<p>Used to place an input or output matrix object in a model, such as a convolution kernel. The matrix is undefined until you double-click on the Matrix graphic in the Model Maker viewer to bring up the Matrix Definition dialog.</p>
<p><b>Table</b></p> 	<p>Used to place a table object in a model, such as a color table. The table is undefined until you double-click on the Table graphic in the Model Maker viewer to bring up the Table dialog.</p>
<p><b>Scalar</b></p> 	<p>Used to place a scalar object in a model, such as a weighting factor. The scalar is undefined until you double-click on the Scalar graphic in the Model Maker viewer to bring up the Scalar dialog.</p>
<p><b>Function</b></p> 	<p>Used to place a function object in a model, such as arithmetic operators, conditional statements, distance functions, and more. The function is undefined until you double-click on the Function graphic in the Model Maker viewer to bring up the Function Definition dialog.</p>
<p><b>Criteria</b></p> 	<p>Used to simplify the process of creating a conditional function. The criteria are undefined until you double-click on the Criteria graphic in the Model Maker viewer to bring up the Criteria dialog.</p>
<p><b>Connect</b></p> 	<p>Used to define connections between data objects and functions. Simply click and drag from a Data Object icon to a Function icon to connect the two. All objects and functions must be connected before the model can be run.</p>
<p><b>Text</b></p> 	<p>Used to place descriptive text on the model diagram. Click on the model page where you want the text to be, and a dialog opens where you type the text.</p>
<p><b>Help</b></p> 	<p>Click to see the On-Line Help document for the Model Maker tool palette.</p>
<p><b>Lock</b></p> 	<p>Use the Lock tool to lock and unlock the currently selected tool for repeated use.</p>
<p><b>Close</b></p>	<p>Click to close the tool palette.</p>

**Table Tool**













This section describes the menus and tools you use with the Table Tool located in the IMAGINE Vector module. The Vector tour guide starts on page 573.

**Table Tool Menu Bar**

**Table A-22 Table Tool Menu Bar**

File	Edit	Utilities	Relate	View
Open...	Enable Edit	Table Copy...	Relate...	New Window...
New...	Add Rows...	Table Rename...	Drop	
Clear	Add A Column...	Table Delete...		
Save	Delete Selected Rows	Table Merge...		
Save As...	Delete Selected Columns			
Close	Undo Last Edit			
Close All	Create New Table...			
	Copy			
	Paste			
	Select All Columns			
	Deselect All Columns			
	Select All Rows			
	Deselect All Rows			
	Select Rows by Criteria...			

**Table A-23 Table Tool Tool Bar**

<p><b>Open</b></p> 	<p>Click to open a table to view.</p>
<p><b>Clear</b></p> 	<p>Click to close the current table and clear the CellArray display.</p>
<p><b>New</b></p> 	<p>Click to start another Table Tool window.</p>
<p><b>Close</b></p> 	<p>Click to close this Table Tool.</p>
<p><b>Save</b></p> 	<p>Click to save your edits.</p>
<p><b>Add Column</b></p> 	<p>Click to add a column to the table.</p>
<p><b>Add Row</b></p> 	<p>Click to add a row to the end of the table.</p>
<p><b>Delete Column</b></p> 	<p>Click to delete the selected column(s) from the table.</p>
<p><b>Delete Row</b></p> 	<p>Click to delete the selected row(s) from the table.</p>
<p><b>Copy</b></p> 	<p>Click to copy the currently selected columns to a buffer.</p>
<p><b>Paste</b></p> 	<p>Click to paste the buffer into the selected columns.</p>
<p><b>Undo</b></p> 	<p>Click to undo the last edit.</p>

**Terrain Surface Editor**

This section describes the menus and tools you use with the Terrain Surface Editor.



*The Terrain Surface Editor tour guide, "CHAPTER 13: Terrain Surface Interpolation", starts on page 283.*



**3D Surfacing Dialog Menu Bar**

**Table A-24 3D Surfacing Dialog Menu Bar**

File	Row	Surface
Read...	Use Only Selected Rows	Surfacing...
Save As...	Add Selected Rows To Used Rows	
Close	Append New Rows To Bottom	

**3D Surfacing Dialog Tool Bar**

**Table A-25 3D Surfacing Dialog Tool Bar**

<b>Read Points</b> 	Click to read data from a file.
<b>Save Points</b> 	Click to save the output to a new file.
<b>Perform Surfacing</b> 	Click to start the surfacing program.



## Vector

This section describes the menus and tools you use in IMAGINE Vector.



*The tour guides, "CHAPTER 5: Vector Querying and Editing" and "CHAPTER 20: IMAGINE Vector™" begin on page 109 and page 573, respectively.*

## Vector Tools

The main Vector tools are described briefly in the following table:

**Table A-26 Vector Tools**

















<b>Select</b> 	Use the Select tool to select features. To add to a selection, Shift-click. To deselect everything, click outside of the selection.
<b>Point</b> 	Use the Point tool to place a point feature in a Vector layer. Editing must be enabled.
<b>Tic</b> 	Use the Tic tool to place a tic feature in a vector layer. Editing must be enabled.
<b>Line</b> 	Use the Line tool to draw new lines in a vector layer. Click to place points along the line where it changes direction. Double-click or middle-click to terminate the line (depending on how your Preferences are set). Editing must be enabled.
<b>Split</b> 	This tool enables you to split a line into two lines. Click at the point where you want to split the line. Editing must be enabled.
<b>Replace</b> 	The Replace tool allows you to replace a portion of a line. Editing must be enabled.
<b>Polygon</b> 	The Polygon tool allows you to create a simple polygon in a vector layer. Double-click or middle-click to close the polygon (depending on how your Preferences are set). Editing must be enabled.
<b>Region Growing</b> 	The Region Growing tool allows you to create a closed polygon in a vector layer being displayed on top of an image. Editing must be enabled.
<b>Split Polygon</b> 	The Split Polygon tool allows you to split an existing polygon into two new polygons. This tool is used when editing shapefiles.
<b>Replace Polygon</b> 	The Replace Polygon tool allows you to add or remove a portion of a polygon. This tool is used when editing shapefiles.

Table A-26 Vector Tools

<b>Append Polygon</b> 	The Append Polygon tool allows you to create a new polygon that shares a border with an existing polygon. This tool is used when editing shapefiles.
<b>Marquee</b> 	The Marquee tool enables you to select multiple features by drawing a rectangle, in which features that are either contained in or intersect the marquee are selected.
<b>Ellipse Marquee</b> 	The Ellipse Marquee tool enables you to select multiple features by drawing an ellipse, in which features that are either contained in or intersect the marquee are selected.
<b>Polygon Marquee</b> 	The Polygon Marquee tool enables you to select multiple features by drawing a polygon, in which features that are either contained in or intersect the marquee are selected.
<b>Line Selection</b> 	The Line Selection tool enables you to select features that intersect a line.
<b>Help</b> 	Click to see the On-Line Help document for these tools.
<b>Lock</b> 	Click the Lock tool to retain the selected tool until another tool is selected. Click again to unlock.
<b>Close</b>	Click to close the Vector tools.

---

**Viewer**

The following section provides information about the Viewer.



*The Viewer tour guide, "CHAPTER 1: Viewer", starts on page 3.*

**About the Viewer**

The Viewer is the main window for displaying raster, vector, annotation, and AOI (area of interest) data. You can open as many Viewer windows as can fit on your screen and your window manager supports.

Viewer functions are available via:

- the Viewer menu bar across the top of the window
- the Viewer tool bar below the Viewer menu bar
- a **Quick View** menu that displays when you right-hold the mouse cursor in a Viewer window



**Viewer Menu Bar**

The menu bar across the top of the Viewer window has the following options:

**Table A-27 Viewer Menu Bar**

<u>F</u> ile	<u>U</u> tility	<u>V</u> iew	<u>A</u> OI
<u>N</u> ew	Inquire <u>C</u> ursor...	<u>A</u> rrange Layers...	<u>T</u> ools...
<u>O</u> pen	Inquire <u>B</u> ox...	Create <u>M</u> agnifier...	<u>U</u> ndo
<u>S</u> ave	Inquire <u>C</u> olor...	<u>T</u> ile Viewers	<u>C</u> ut
View to <u>.I</u> MG File...	Inquire <u>S</u> hape...	<u>W</u> indow Information...	<u>D</u> elete Raster Mask
<u>P</u> rint...	Inquire <u>H</u> ome	<u>S</u> plit	<u>G</u> roup
<u>C</u> lear	<u>M</u> easure...	<u>Z</u> oom	<u>U</u> ngroup
<u>C</u> lose	Selector <u>P</u> roperties...	<u>S</u> cale	<u>R</u> eshape
Close Other Viewers	<u>B</u> lend...	<u>R</u> otate...	<u>I</u> nvert Polygon
	<u>S</u> wipe...	Rotate/ <u>F</u> lip/ <u>S</u> tretch...	<u>E</u> lement Properties...
	<u>F</u> licker...	<u>N</u> orth Arrow	<u>S</u> tyles...
	Enable Hyperlinks	<u>S</u> cale Bar	<u>S</u> eed Properties...
	<u>L</u> ayer Info...	<u>V</u> irtual Roaming	<u>C</u> opy Selection to AOI...
	<u>H</u> FA Info...	<u>L</u> ink/ <u>U</u> nlink Viewers	<u>L</u> ink
	<u>I</u> mage Drape...	<u>B</u> ackground Color...	<u>T</u> ablet Input
	<u>V</u> irtual GIS...	<u>S</u> tatus Bar	
		<u>S</u> croll Bars	
		<u>M</u> enu Bar	
		<u>T</u> ool Bar	
		<u>B</u> orders	



NOTE: The underlined letters indicate keyboard shortcuts (see page 643).

**Table A-28 Viewer Menu Bar, Continued**

<u>R</u> aster	<u>V</u> ector	<u>A</u> nnotation	<u>T</u> erraModel	<u>H</u> elp
Tools...	<u>E</u> nable Editing	Tools...	<u>P</u> alette...	<u>H</u> elp for Viewer
<u>U</u> ndo	T <u>o</u> ols...	<u>U</u> ndo	<u>S</u> elect Layer...	
<u>C</u> opy	<u>U</u> ndo	C <u>u</u> t		
<u>P</u> aste...	C <u>u</u> t	<u>C</u> opy		
<u>B</u> and Combinations...	<u>C</u> opy	<u>P</u> aste		
<u>P</u> ixel Transparency...	<u>P</u> aste	<u>G</u> roup		
Data <u>S</u> caling...	<u>D</u> elete	<u>U</u> ngroup		
<u>C</u> ontrast	Res <u>h</u> ape	Res <u>h</u> ape		
<u>F</u> iltering	Spl <u>i</u> ne	<u>R</u> aise		
<u>R</u> ecode...	Densify	<u>L</u> ower		
<u>F</u> ill...	<u>G</u> eneralize	D <u>i</u> stribute		
Offset <u>V</u> alues...	<u>J</u> oin	<u>F</u> lip		
<u>I</u> nterpolate...	Group/Ungroup	Align Object North		
Recompute Statistics	<u>A</u> tttributes...	Align <u>m</u> ent...		
Recompute Statistics on Window	<u>V</u> iewing Properties...	<u>E</u> lement Properties...		
<u>A</u> tttributes...	<u>S</u> ymbology...	<u>S</u> tyles...		
<u>G</u> eometric Correction...	<u>O</u> ptions...	<u>A</u> tttributes...		
<u>S</u> et Drop Point...	<u>S</u> eed Properties...	<u>S</u> eed Properties...		
Profile Tools...	Copy Selection to Vector...	Copy Selection to Annotation...		
Relief <u>S</u> hading Tool...	Tablet Input	Tablet Input		

**Viewer Tool Bar**

The following icons are located in the Viewer tool bar:

**Table A-29 Viewer Tool Bar**



















<p><b>Open</b></p> 	<p>Click to open a raster file.</p>
<p><b>Close</b></p> 	<p>Click to close the top layer displayed in the Viewer without closing the Viewer.</p>
<p><b>Info</b></p> 	<p>Click to display the ImageInfo or Vector Info dialogs.</p>
<p><b>Save</b></p> 	<p>Click to save the top, nonAOI layer to a file.</p>
<p><b>Print</b></p> 	<p>Click to print the contents of the Viewer.</p>
<p><b>Erase</b></p> 	<p>Click to close all layers in a Viewer without closing the Viewer.</p>
<p><b>Reset Zoom</b></p> 	<p>Click to reset the image to the original zoom.</p>
<p><b>Zoom In</b></p> 	<p>Click to zoom in by two from the center of the displayed portion of the image.</p>
<p><b>Zoom Out</b></p> 	<p>Click to zoom out by two from the center of the displayed portion of the image.</p>
<p><b>Measure</b></p> 	<p>Click to measure points, lines, and areas in the displayed layer. The Measurement tool displays.</p>
<p><b>Inquire Cursor</b></p> 	<p>Click to start/update the inquire cursor. The Inquire Cursor dialog displays.</p>
<p><b>Tools</b></p> 	<p>Click to display the AOI, Annotation, or Vector tool palette for the top layer.</p>

Table A-29 Viewer Tool Bar (Continued)

<b>Profile</b> 	Click to start the Profile tools.
<b>Select Tool</b> 	Click to reset the cursor to an arrow.
<b>Zoom In</b> 	Click to zoom in by 2. You must click in the Viewer to indicate the center of the zoomed area.
<b>Zoom Out</b> 	Click to zoom out by 2. You must click in the Viewer to indicate the center of the reduced area.
<b>Roam</b> 	Click to roam the image. Simply drag the hand over the image to pan up, down, left, and right.
<b>GPS Tool</b> 	(PC Only) Click to start using the GPS tool, if it is installed.

### Duplicated Functionality

Some functionality is duplicated in these areas. For example, when starting up an **Inquire Cursor** to obtain information on individual image pixels, you can:

- click **Utility | Inquire Cursor** on the Viewer menu bar
- right-hold in the Viewer window and drag to select **Inquire Cursor...** from the **Quick View** menu
- click the Inquire Cursor icon on the Viewer tool bar:



### Keyboard Shortcuts

You can access some Viewer options using the keyboard.

*NOTE: Keyboard shortcuts for use on Sun workstations use the **Meta** key in the place of **Alt**.*

- Display the **File** menu by typing **Alt-f**.
- Display the **View** menu by typing **Alt-v**.
- Open a raster file by typing **Ctrl-r**.
- Open a vector coverage by typing **Ctrl-v**.
- Open an annotation file by typing **Ctrl-a**.



- Save a layer by typing **Ctrl-s**.



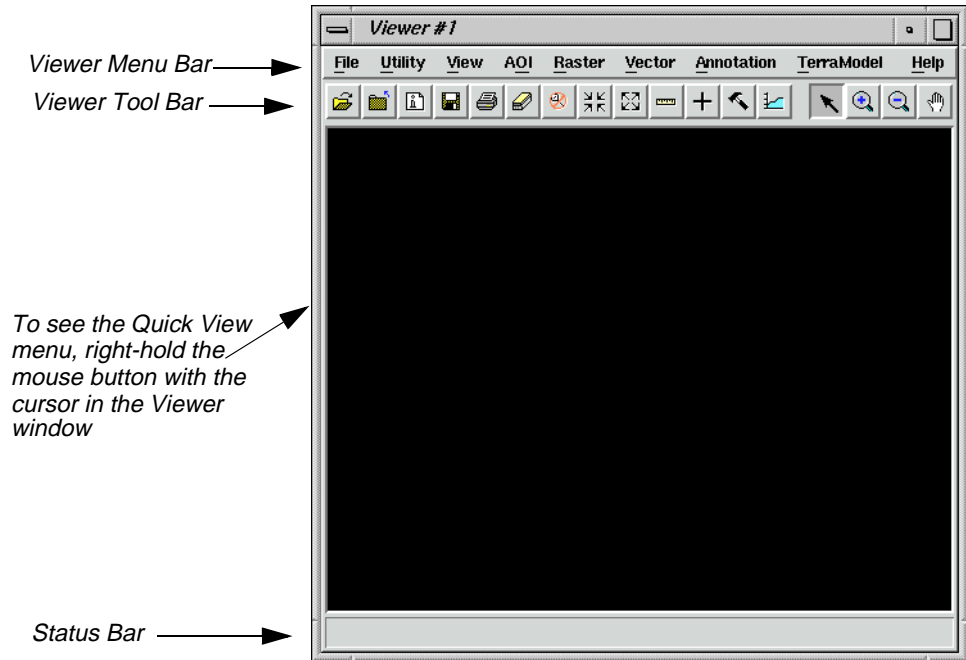

Following is an example of the Viewer:



## Histogram Edit Tools

Five icons in the Breakpoint Editor make up the Histogram Edit tools:

**Table A-30 Histogram Edit Tools**

<b>Insert Breakpoint</b> 	Click to add a breakpoint to the active lookup table graph. Click on the graph where you want to add the breakpoint.
<b>Cut Breakpoint</b> 	Click to delete a breakpoint from the active lookup table graph. Click on the breakpoint that you want to delete.
<b>Left-Right Curve</b> 	Click to create a curve from left-to-right between two breakpoints on the active graph. Click on the graph where you want the curve to begin. The curve is redrawn from the new point to the left-most point in the graph. All points in between are deleted.
<b>Right-Left Curve</b> 	Click to create a curve from right-to-left between two breakpoints on the active graph. Click on the graph where you want the curve to begin. The curve is redrawn from the new point to the right-most point in the graph. All points in between are deleted.
<b>Reference Line</b> 	Click to draw a dashed reference line showing the position of the breakpoint line before editing begins. Click again to turn it off and reset the reference line.

**Histogram Numbers**

When the mouse cursor is in a histogram, other numbers display near the graph to show you values that are represented by the cursor location:

- At the bottom center, the data value represented by the cursor location is shown.
- At center left, the frequency (number of pixels) of that data value is shown, followed by the cursor Y position.

**Manipulating Lookup Table Breakpoints**

The lookup table (LUT) graph can be edited by moving, adding, or deleting breakpoints. Breakpoints are the vertices of the lookup table graph. There is a breakpoint each time the slope of the line changes. Breakpoints are represented by small boxes along the graph line. You can manipulate breakpoints in the following ways:

- hold on a breakpoint and drag it to a new location
- add a breakpoint with a Shift-click in the desired location
- remove a breakpoint with a Ctrl-click on the breakpoint that you want to delete
- copy a lookup table from one color gun to another using the **Graph Options** menu (this menu opens when you right-hold inside the X,Y axis of a histogram)
- use the Histogram Edit tools from the tool bar











**Image Drape Menu Bar**

**Table A-31 Image Drape Menu Bar**

File	Utility	View	Position	Raster
New	Options...	Update Display	Current Position...	Band Combinations
Open	Dump Contents to Viewer	LOD Control...	Reset Position	Toggle Transparency
Save	Layer Info...	Arrange Layers...	Save Position	
View to .IMG File...	HFA Info	Sun Positioning...	Goto Last	
Print...		Link/Unlink with Viewer	Positions Editor...	
Close Top Layer		Show Coverage in Viewer		
Clear Scene		Background Color...		
Close Image Drape				

Image Drape Tool Bar

**Table A-32 Image Drape Tool Bar**

<p><b>Open</b></p> 	<p>Click to open a file.</p>
<p><b>Close</b></p> 	<p>Click to close the top feature layer.</p>
<p><b>ImageInfo</b></p> 	<p>Click to open the Image Information dialog.</p>
<p><b>Update</b></p> 	<p>Click to update (refresh) the image in the Image Drape viewer.</p>
<p><b>Print</b></p> 	<p>Click to print the image in the Image Drape viewer.</p>
<p><b>Clear</b></p> 	<p>Click to remove all layers from Image Drape.</p>
<p><b>Save Current Position</b></p> 	<p>Click to save the current position of the Eye and Target.</p>
<p><b>Goto</b></p> 	<p>Click to return to the original position of the Eye and Target.</p>
<p><b>Observer Positioning</b></p> 	<p>Click to open the Position Parameters dialog.</p>
<p><b>Dump to Viewer</b></p> 	<p>Click to dump the contents of the Image Drape viewer (3-D) to a Viewer (2-D).</p>
<p><b>Sun Position</b></p> 	<p>Click to open the Sun Positioning dialog.</p>

# Index

## Symbols

.gen file (generic data) 177  
 .preview.img file (import preview) 165  
 .sig file (signature file) 456

## Numerics

3D Surfacing dialog 284  
 3X3 Edge Detect 249  
 3X3 Edge Detect dialog 249

## A

Accuracy assessment 497  
 Accuracy Assessment dialog 498  
 Add Image icon 63, 599  
 Add Images for Mosaic dialog 296  
 Add intermediate hypothesis 510  
 Add Random Points dialog 500  
 Affine Model Properties dialog 150  
 Air photo images 291  
 AIRSAR 569  
 Animated Zoom 18  
 Annotation 73
 

- borders 73
- color 73
- copy 620
- cut 620
- deselect 86
- edit 97
- grid lines 73, 83
- group elements 83, 620
- legend 73
- line style 73
- lines 85
- neatline 619
- paste 620
- scale bar 73
- select 618
- style 85
  - change 85

symbol 73  
 text 73, 85
 

- font 73
- point size 85

 tools 618, 619
 

- ellipse 618
- grid line 83, 619
- legend 88, 619
- map frame 77, 619
- marquee 618, 620
- pointer 618
- polygon 618
- polyline 619
- rectangle 618
- scale bar 87, 619
- select 617
  - select map frame 82, 619
  - symbol 94, 619
  - tick mark 73, 83, 619
- ungroup elements 620

 Annotation Text dialog 91, 94  
 AOI 22, 456, 473
 

- selecting signatures 458

 AOI Cutline icon 301  
 AOI Styles dialog 24  
 AOI tool palette 23, 294, 301, 458  
 Arc icon 619  
 Archive dialog 69  
 Archive External icon 600  
 Archive Retrieval 600  
 Archive Retrieval icon 600  
 ArcInfo
 

- vector coverage 109, 573

 Area Definition dialog 67  
 Area Fill dialog 36  
 Arrange Layers dialog 15, 23, 39, 82, 463, 468, 472  
 ASCII file 626  
 Attention dialog 122  
 Attribute Options dialog 482  
 Attributes viewer 115, 125, 127

# Index

## B

Band Combinations dialog 51  
Band-to-color gun assignment 3  
Batch  
    add multiple files 192  
    create new variable 204  
    modify commands automatically 205  
    modify commands manually 187  
    multiple files/multiple commands 195  
    multiple files/single command 185, 190  
    process later 190  
    process now 185  
    save/load options 209  
    single file/single command 183  
    use commands as they are 184

Batch scheduler NT 182

Box Zoom 19

Breakpoint Editor 29

Breakpoints 645

Brightness 28  
    adjust 27

Brightness Adjustment dialog 567

Brightness Inversion dialog 255

Build 589

Build Vector Layer Topology dialog 589

## C

Camera Model 267

Camera Model Properties dialog 270

Canvas 297

Catalog Default icon 600

Catalog icon 62

Catalog Image dialog 63

CellArray 38, 116, 626

    add columns 127

    column

        adjust size 41

    Column Options menu 41, 42

    GCP Tool 143

    report 44

    Row Selection menu 41, 116, 118, 347

    select columns 41

    select rows 41

        using criteria 43

    selection criteria 43

    statistics 42

Change Colors 499

Change Colors dialog 499

Chart Options dialog 48

Chip extraction 17

Chip Extraction Viewer 140, 272, 277

Choose AOI dialog 297, 301

Circular Mask dialog 228

Circular Mask icon 598

Class color

    change 38

Class name

    edit 368

Classification 101, 104, 455, 487, 573

    decision rule 480

        feature space 481

        Mahalanobis distance 481

        maximum likelihood 481

        minimum distance 481

        parallelepiped 481

    distance file 481

    output file 481

    overlay 104, 487

    steps 595

    supervised 455

    unsupervised 101, 455, 484

Classification icon 503

Classification menu 457, 485, 504

Classification tools 378

Classified Image dialog 498

Classifier icon 457, 485, 493

Clean 589

Clean Vector Layer dialog 590

Clear icon 597

Close icon 632, 642

Coefficient of variation 550, 551

    calculating 549

color balancing





- mosaic 314
- Color Chooser dialog 38, 40, 367
- Color printer 95
- Colorwheel (see Color Selector dialog)
- Column Attributes dialog 127
- Column icon 41
- Column Properties dialog 41, 105, 367, 489
- Composer icon 74, 95, 97
- Compositions dialog 95, 98
- Conditions
  - copy 512
- Connect icon 634
- Constant value 36
- Contingency matrix 473
- Contingency Matrix dialog 473
- Contrast 28
  - adjust 26, 47, 48, 50, 51, 52
  - shift/ bias 32
- Contrast matching 310
- Contrast stretch
  - linear 26
  - piecewise linear 27
- Contrast Tool (piecewise) dialog 27
- Contrast Tool dialog 27
- Convolution dialog 248
- Convolution kernel 354
  - define 356
  - summary 356
- Coordinate
  - reference 624
- Copy icon 359, 633
- Copy rules and conditions 512
- Copy Vector Layer dialog 110, 575
- Create Feature Space Maps dialog 464
- Create Frame Instructions dialog 78
- Create GCP tool 143
- Create icon 597
- Create New Signature icon 460
- Create New Table dialog 578
- Create Rule Graphic icon 506
- Create Sensitivity Layer 342
- Creating New Relate dialog 581

- Crisp dialog 251
- Criteria (see Selection Criteria dialog)
- Criteria dialog 380, 634
- Criteria icon 634
- Cursor box 17, 78, 80
  - rotate 79
- Cut icon 633
- Cutline 300
- Cutline Selection viewer icon 300

## D

- Dangle length 591

## Data

- ASCII 126
- display 135
  - annotation 639
  - AOI 639
  - preference 3, 61
  - raster 639
  - vector 639
- export (see Export)
- flood plain 349, 630
- georeferenced 87
- import (see Import)
- land cover 349, 630
- Landsat MSS 3
- Landsat TM 3, 6, 135, 630
- raster 573
- satellite 630
- sensitivity 366
  - combine with SPOT 360, 365
- slope 344, 630
- SPOT 3
- SPOT panchromatic 135, 342, 354, 361, 630
  - enhance 354–359
- subset 345
- thematic 73
- transparent 39
- vector 73, 573
  - build 589
  - clean 589



## Index

- copy 110, 126, 574, 575
- create 123
- edit 119
  - undo 123
- select 115, 116
- style 112
- symbolology 584
- Data file value
  - frequency 645
- Data Preparation menu 102, 283
- Data View 174, 567, 569
  - icons 611
  - menu bar 611
  - tool bar 611
- Data Viewer dialog 174
- DataPrep icon 102, 307
- Default symbol 93
- Defined Areas dialog 68
- Delete icon 600
- DEM 34
  - edit 34
- Dialog xxx
  - 3D Surfacing 284
  - 3X3 Edge Detect 249
  - Accuracy Assessment 498
  - Add Images for Mosaic 296
  - Add Random Points 500
  - Affine Model Properties 150
  - Annotation Text 91, 94
  - AOI Styles 24
  - Archive 69
  - Area Definition 67
  - Area Fill 36
  - Arrange Layers 15, 23, 39, 82, 463, 468, 472
  - Attention 122
  - Attribute Options 482
  - Band Combinations 51
  - Brightness Adjustment 567
  - Brightness Inversion 255
  - Build Vector Layer Topology 589
  - Camera Model Properties 270
  - Catalog Image 63
  - Chart Options 48
  - Choose AOI 297, 301
  - Circular Mask 228
  - Classified Image 498
  - Clean Vector Layer 590
  - Color Chooser 38, 40, 367
  - Column Attributes 127
  - Column Properties 41, 105, 367, 489
  - Compositions 95, 98
  - Contingency Matrix 473
  - Contrast Tool 27
  - Contrast Tool (piecewise) 27
  - Convolution 248
  - Copy Vector Layer 110, 575
  - Create Feature Space Maps 464
  - Create Frame Instructions 78
  - Create New Table 578
  - Creating New Relate 581
  - Crisp 251
  - Criteria 380, 634
  - Data Viewer 174
  - Defined Areas 68
  - Edge Enhancement 555
  - Export Column Data 126
  - Export ERDAS 7.5 LAN Data 168
  - Eye/Target Edit 57
  - Feature Space to Image Masking 474
  - Fill Style Chooser 586
  - Filter Options 232
  - Form View 67
  - Formula 106, 491
  - Fourier Transform 217
  - Function Definition 351, 357, 361, 634
  - GCP Matching 146
  - GCP Tool Reference Setup 277
  - Generate Script 374
  - Geo Correction Tools 138, 148, 270
  - Histogram 477
  - Histogram Plot Control 477
  - Hypo Props 505
  - IHS to RGB 263



- Image Files 179
- ImageInfo 67, 179, 280, 552
- IMAGINE Radar Interpreter module 545
- Import Column Data 128
- Import Generic Binary Data 174
- Import Options 165, 285
- Import SPOT 162
- Import/Export 161, 167, 567, 569
- Indices 261
- Inquire Box Coordinates 166, 347
- Inquire Color 11
- Inquire Cursor 10, 28, 150, 463, 642
- Inquire Shape 12
- Interpolate 35
- Inverse Fourier Transform 224
- Job Status 164, 250, 305, 312, 323, 465, 576
- Knowledge Base Editor 504
- Legend Properties 89
- Limits 470
- Line Style Chooser 86, 113, 121
- Link/Unlink Instructions 20, 370
- Linked Cursors 466
- List of Recent Files 7
- Low/High Pass Filter 221
- Map Frame 78, 82
- Map Frame Data Source 77
- Matching Options 299, 310, 317, 321
- Matrix 356, 634
- Measurement Tool 642
- Model Librarian 375
- New Column 579
- New Map Composition 74
- New Vector Layer 124, 129
- Open FFT Layer 219
- Open Files 494
- Open Info Table 577
- Options 55, 116, 124
- Output Image Options 303
- Overlay True Color on Surface 53
- Page Setup 376
- Polynomial Model Properties 138, 145, 148
- Position Parameters 58
- Preview Options 163, 164
- Print 14, 377
- Print Map Composition 96
- Projection Chooser 276
- Properties 112, 120
- Radar Speckle Suppression 548, 550, 558
- Raster 342, 344, 347, 349, 352, 356, 380, 629, 633
- Read Points 284
- Recode 347, 349
- Rectangular Mask 229
- Red Mouse Linear Mapping 32
- Reference GCC File 277
- Region Grow Options 461
- Region Growing Properties 25, 461
- Relate Manager 581
- Report Format Definition 44
- Resample 148, 151, 279
- RGB to IHS 262
- Rule Props 507
- Run Mosaic 304, 311, 322
- Save AOI As 26, 295
- Save As 46
- Save Layer As 223, 234
- Save Model 353, 359, 383
- Save Options File 177
- Save Signature File As 468
- Save Symbology As 588
- Scalar 361, 634
- Scale Bar Instructions 87
- Scale Bar Properties 87
- Select A Directory 7
- Select Layer To Add 4, 7, 15, 20, 47, 76, 96, 104, 111, 119, 123, 129, 136, 215, 250, 256, 288, 345, 365, 456, 488, 546, 555, 559, 562, 583
- Select Profile Tool 47
- Selection Criteria 43, 118, 347
- Sensor Merge 561



## Index

- Set Geometric Model 137, 150, 270
  - Set Grid/Tick Info 83
  - Set Overlap Function 302, 311, 322
  - Set Parallelepiped Limits 470
  - Set Window 344, 383
  - Shift/Bias Adjustment 31
  - Signature Alarm 470
  - Signature Objects 475
  - Signature Separability 478
  - Slant Range Adjustment 568
  - Spectral Statistics 49
  - Statistics 42, 480
  - Styles 85
  - Sun Positioning 56
  - Supervised Classification 481
  - Surfacing 287
  - Symbol Chooser 93, 121, 586
  - Symbol Properties 94
  - Symbology 584
  - Table 634
  - Tasseled Cap 258
  - Tasseled Cap Coefficients 259
  - Text Properties 92
  - Text String 370, 371
  - Text Style Chooser 86
  - Texture Analysis 564
  - Threshold 493
  - Threshold to File 497
  - Unique Value 585
  - Unsupervised Classification 485
  - Unsupervised Classification (Isodata)
    - 102
  - Vector 633
  - View Extent 9
  - View Signature Columns 458
  - Viewer Flicker 107, 491, 496
  - Wallis Adaptive Filter 558
  - Wedge Mask 230
  - Digitize Points icon 35
  - Digitizing tablet 626
  - Display Another icon 599
  - Display options 8
  - Display Single icon 66, 599
  - Display thematic data 15
  - Divergence 478
- ### E
- Edge Enhancement dialog 555
  - Electrostatic plotter 95
  - Ellipse icon 34, 618
  - Ellipse measurement 12
  - Enhancement 573
    - in graphical models 354
    - radiometric 254
    - spatial 247
    - spectral 258
  - Erase icon 46, 642
  - ERDAS Field Guide 281, 545, 568
  - ERDAS IMAGINE
    - start 109, 574
  - ERDAS IMAGINE icon panel xxi, 74, 97, 102,
    - 161, 342, 457, 485, 493
  - ERDAS IMAGINE Viewer 76, 78, 365, 639
  - ERS-1 569
  - Evaluate 104, 487
  - Export
    - LAN data 167
    - statistics 169
  - Export Column Data dialog 126
  - Export ERDAS 7.5 LAN Data dialog 168
  - Eye/Target Edit dialog 57
- ### F
- Feature space 456
    - to image masking 474
  - Feature Space image 464
    - display image 466
  - Feature Space to Image Masking dialog 474
  - Feature Space viewer 466
  - Field of View (FOV) 58
  - Fill Style Chooser dialog 586
  - Filter 249
    - Prewitt Gradient 555
  - Filter Options dialog 232



Form View dialog 67  
 Formula dialog 106, 491  
 Fourier Analysis menu 217  
 Fourier Editor 218  
 Fourier Transform  
     create 215  
     Editor 215  
     start 218  
     using tool bar icons 232  
 Fourier Transform dialog 217  
 Frame area 77  
 FS to Image Masking 474  
 Function Definition dialog 351, 357, 361,  
     634  
 Function icon 302, 634  
 Fuyo 569  
 Fuzzy tolerance 591

## G

.gen file (generic data) 177  
 GCP 17, 626  
     calculating 145  
     corresponding 626  
     delete 144  
     input 624  
     number required 145  
     placement 143  
     point ID 626  
     reference 624  
     select 144  
 GCP Matching dialog 146  
 GCP Tool 277, 624  
     CellArray 143  
     edit GCPs 624  
     tool bar 625  
 GCP Tool Reference Setup dialog 277  
 Generate Script dialog 374  
 Geo Correction Tools dialog 138, 148, 270  
 Geologic discrimination 564  
 Geometric correction 137, 270  
 Geometric Correction Tool  
     starting 137

Georeferencing 135, 267  
 Global value 37  
 Graph Options menu 645  
 Graphical model 252  
     adjust class colors 366  
     annotation  
         add 370  
         edit 371  
         select 372  
         style 371  
     create 628, 630  
     define function 351, 357, 361  
     define input 344, 356, 361  
     define output 352, 358, 363  
     display output 365  
     edit 253  
     generate text script from 373  
     print 376  
     run 354, 359  
     save 359  
     title 370  
     using scalars in 360  
     view 252  
 Graphical Query viewer 64  
 Graphics  
     presentation 73, 613  
 Grid/Tick icon 619  
 Ground control point (see GCP)

## H

Help icon 619, 634  
 High-Pass Filter icon 233, 598  
 Histogram 552  
 Histogram dialog 477  
 Histogram graphic 30  
 Histogram icon 477  
 Histogram manipulation 29  
 Histogram Plot Control dialog 477  
 Hypothesis  
     add intermediate 510  
     rules for 506  
 Hypothesis properties dialog 505



# Index

## I

### Icons

- Add Image 63, 599
- AOI Outline 301
- Arc 619
- Archive External 600
- Archive Retrieval 600
- Catalog 62
- Catalog Default 600
- Circular Mask 598
- Classification 503
- Classifier 457, 485, 493
- Clear 597
- Close 632, 642
- Column 41
- Composer 74, 95, 97
- Connect 634
- Copy 359, 633
- Create 597
- Create New Signature 460
- Create Rule Graphic 506
- Criteria 634
- Cut 633
- Cutline Selection viewer 300
- DataPrep 307
- Delete 600
- Digitize Points 35
- Display Another 599
- Display Single 66, 599
- Ellipse 34, 618
- Erase 46, 642
- Function 302, 634
- Grid/Tick 619
- Help 619, 634
- High-Pass Filter 233, 598
- Histogram 477
- Image Interpreter 217, 241, 247
- Image Matching 299
- Import 161, 575
- Info 599, 642
- Input 299
- Inquire Cursor 617, 642
- Intersection 299
- Legend 619
- Line Selection 117
- Lock 35, 619, 634
- Low-Pass Filter 233, 598
- Manual Insert 600
- Map Frame 619
- Marquee 117, 618
- Matrix 634
- Measure 642
- Measurement 12
- Modeler 342, 374
- Mouse Linear Mapping 32
- New Window 632
- Open 7, 15, 76, 119, 136, 137, 256, 305, 323, 342, 345, 552, 554, 597, 599, 617, 632, 642
- Open Existing Catalog 599
- Output 303
- Output Image 303
- Overview 633
- Paste 360, 633
- Polygon 618
- Polyline 13, 51, 619
- Print 14, 377, 617, 632
- Profile 643
- Query 65
- Radar 547
- Raster 633
- Rectangle 618
- Rectangular Mask 598
- Region Grow 461, 619
- Reset Zoom 617
- Roam 21, 618, 643
- Run 33, 224, 354, 359, 598, 633
- Save 95, 353, 359, 597, 617, 632, 642
- Scalar 634
- Scale Bar 619
- Select 597, 617, 618, 633, 643
- Select Area for Zooming 64
- Select Map Frame 619
- Shift/Bias 31

- Statistics 480
- Symbol 619
- Table 634
- Text 90, 619, 634
- Tools 23, 114, 130, 617, 633, 642
- Vector 110, 574, 589, 633
- Viewer 123, 128, 135, 250, 292, 305, 323, 547
- Visual Query 64, 599
- Wedge Mask 598
- Window 354
- Zoom 633
- Zoom In 16, 618, 642
- Zoom Out 618, 642, 643
- IHS 39
- IHS to RGB 262, 263
- IHS to RGB dialog 263
- Image
  - invert 255
  - reverse 255
- Image Catalog 62
  - add information 63
  - create 61
  - menu bar 599
  - tool bar 599
- Image Commands tool 153
- Image Drape viewer 55
- Image Enhancement menu 558
- Image Files dialog 179
- Image Interpreter 9, 239, 341, 497
  - functions 606
    - Convolution 554
    - Neighborhood 554
- Image Interpreter icon 217, 241, 247
- Image Interpreter menu 217, 241, 248
- Image matching 310
- Image Matching icon 299
- Image resampling 9
- Image Stacking 310
- ImageInfo
  - icons 612
  - menu bar 612
  - tool bar 612
- ImageInfo dialog 67, 179, 280, 552
- ImageInfo utility 178
  - edit 178
- IMAGINE Radar Interpreter module
  - using the IMAGINE Radar Interpreter module 545
- IMAGINE Radar Interpreter module dialogs 545
- IMAGINE Radar Interpreter module functions
  - Brightness Adjustment 567
  - Edge Enhancement 554
  - Luminance Modification 557
  - Sensor Merge 557
  - Slant Range Adjustment 568
  - Speckle Suppression 545
  - Wallis Adaptive Filter 557
- Import
  - binary data 173
  - column data 128
  - decimated image 164
  - generic data 173
  - Landsat TM 164
  - SPOT data 161
  - subset 166
- Import Column Data dialog 128
- Import Generic Binary Data dialog 174
- Import icon 161, 575
- Import Options dialog 165, 285
- Import SPOT dialog 162
- Import/Export dialog 161, 167, 567, 569
- Index 261
- Indices dialog 261
- Info icon 599, 642
- Input icon 299
- Input Slope Layer 344
- Inquire Box Coordinates dialog 166, 347
- Inquire Color dialog 11
- Inquire Cursor 150, 643
  - icon 643
  - style 11



## Index

Inquire Cursor dialog 10, 28, 150, 463, 642  
Inquire Cursor icon 617, 642  
Inquire Shape dialog 12  
Interpolate dialog 35  
Intersection icon 299  
Inverse Fourier Transform dialog 224  
ISODATA 101, 484

### J

Jeffries-Matusita 478  
JERS-1 569  
Job Status dialog 164, 250, 305, 312, 323, 465, 576

### K

Kernel 249  
    CellArray 250  
    library 249  
Keyboard shortcut 6  
Knowledge Base  
    test 514  
Knowledge Base Editor dialog 504  
Knowledge engineer 503  
    add hypothesis 504  
    add intermediate hypothesis 510  
    ANDing criteria 527  
    copy and edit rules/conditions 512  
    enter rules for hypothesis 506  
    enter variable for rule 507  
    graphic model option 523  
    pathway feedback 539  
    prompt analyst 537  
    set up output classes 503  
    test knowledge base 514  
    use with spatial logic 529

### L

Label point 114  
Land use planning 629  
LANDSAT images 306  
Legend 88  
    columns 90

    position 89, 90  
    specify contents 89  
Legend icon 619  
Legend Properties dialog 89  
Level of Detail 326  
Limits dialog 470  
Line  
    join 123  
    reshape 123  
    split 122  
Line measurement 12  
Line of constant range 567  
Line Selection icon 117  
Line Style Chooser dialog 86, 113, 121  
Link box tool 140  
Link symbol 21  
Link/Unlink Instructions dialog 20, 370  
Linked Cursors dialog 466  
List of Recent Files dialog 7  
Lock icon 35, 619, 634  
Lookup table (LUT) graph 645  
    breakpoints 645  
    copy 645  
    rotate 33  
    shift 33  
Lookup table (LUT) values  
    change 26  
    modify 29  
    reset 29  
Low/High Pass Filter dialog 221  
Low-Pass Filter icon 233, 598

### M

Magnifier window 16  
Magnify image (see Zoom)  
Manual insert 600  
Manual Insert icon 600  
Map  
    area 77  
    create 74  
    prepare data layers 76  
    steps 73





- edit 97
- file (.map) 97
- name 75
- output size 613
- outside margin 84
- planning 613
- print 95
  - to file 96
- sample 615
- save 95
- scale 75
- size 75
- title 90
- units 75, 77
  - page 77
- Map Composer
  - components 615
  - icon 74, 97
  - menu bar 616, 618
  - start 74
  - tool bar 617
  - viewer 75
- Map Composer menu 74, 97
- Map frame 77
  - adjust size 79
  - create 76
  - delete 82
  - dimensions 77
  - edit 81
  - position 78, 80
  - reference to image in Viewer 80
  - scale 78, 80
  - select 82
  - size 78
- Map Frame Data Source dialog 77
- Map Frame dialog 78, 82
- Map Frame icon 619
- Map Path Editor 98
- Map projection 10, 135, 162, 169, 267, 600, 625
  - State Plane 135
- Marquee icon 117, 618
- Mask 474
- Matching Options dialog 299, 310, 317, 321
- Matrix dialog 356, 634
- Matrix icon 634
- Measure icon 642
- Measurement icon 12
- Measurement Tool dialog 642
- Measurement Tool viewer 12
- Menu
  - Classification 457, 485, 504
  - Data Preparation 102
  - Fourier Analysis 217
  - Graph Options 645
  - Image Enhancement 558
  - Image Interpreter 217, 241, 248
  - Map Composer 74, 97
  - Radar 547
  - Radar Interpreter 548
  - Radiometric Enhance 254
  - Session xxii
  - Spatial Enhancement 248
  - Spatial Modeler 342, 374
  - Spectral Enhancement 258
  - Tools xxiv
  - Utilities xxv
  - Vector Utilities 110, 574, 576, 589
- Mineral ratio 261
- Model 626
  - using conditional statements 351
  - working window 344, 383
- Model Librarian dialog 375
- Model Maker 239, 252, 341
  - functions 362
    - Analysis 362
    - Conditional 362
    - CONVOLVE 358
    - Criteria 378
    - EITHER 362
    - STRETCH 362, 363
  - start 342
  - tool palette 633
  - viewer



## Index

- menu bar 632
- tool bar 632
- Model Maker viewer 631
- Modeler icon 342, 374
- Modify commands automatically 205
- Modify commands manually 187
- Modify variables 200
- Mosaic 291
  - color balancing 314
  - cutline 300
  - display 305
  - input 294
  - intersection 299
  - output 303
  - run 304, 311
- Mosaic Image List 297
- Mosaic Tool
  - menu bar 621
  - tool bar 621
  - viewer 293, 308
- Mouse linear mapping 32
- Mouse Linear Mapping icon 32

**N**

- Neatline 83, 84
- New Column dialog 579
- New Map Composition dialog 74
- New variable 204
- New Vector Layer dialog 124, 129
- New Window icon 632
- No Link symbol 21
- North arrow 92

**O**

- Observer 58
- On-Line Help xxvii
- Opacity 40
- Open Existing Catalog icon 599
- Open FFT Layer dialog 219
- Open Files dialog 494
- Open icon 7, 15, 76, 119, 136, 137, 256, 305, 323, 342, 345, 552, 554, 597, 599, 617,

- 632, 642
- Open Info Table dialog 577
- Options dialog 55, 116, 124
- Orthorectification 267
- Output icon 303
- Output Image icon 303
- Output Image Options dialog 303
- Overlay thematic data 53
- Overlay True Color on Surface dialog 53
- Overview icon 633

**P**

- .preview.img file (import preview) 165
- Page Setup dialog 376
- Paste icon 360, 633
- Pattern Polygon Fill 586
- Point measurement 12
- Polygon icon 618
- Polygon measurement 12
- Polyline icon 13, 51, 619
- Polynomial Model Properties dialog 138, 145, 148
- Position Parameters dialog 58
- PostScript 377
- PostScript device 95
- Preference Editor 3, 243
  - eml 3
  - saving changes 6
  - viewer 4
- Preview Options dialog 163, 164
- Preview window xxx, 34, 39, 91, 93, 587
- Prewitt Gradient filter 555
- Print dialog 14, 377
- Print icon 14, 377, 617, 632
- Print Map Composition dialog 96
- Profile icon 643
- Projection Chooser dialog 276
- Properties dialog 112, 120

**Q**

- Query
  - coordinates 11



- pixel information 10
- Query icon 65
- Quick View menu 16, 28, 150, 256, 598, 617, 639

**R**

- Radar icon 547
- Radar Interpreter menu 548
- Radar menu 547
- Radar Speckle Suppression dialog 548, 550, 558
- RADARSAT 569
- Radiometric Enhance menu 254
- Raster Attribute Editor 34, 38, 40, 41, 104, 105, 366, 483, 487, 489, 497
- Raster dialog 342, 344, 347, 349, 352, 356, 380, 629, 633
- Raster icon 633
- Raster options 292
- Rayleigh distribution 549
- Read Points dialog 284
- Real Time Zoom 19
- Recode 342, 347, 349, 497
  - using Criteria 347
- Recode dialog 347, 349
- Rectangle icon 618
- Rectangle measurement 12
- Rectangular Mask dialog 229
- Rectangular Mask icon 598
- Rectification 17
  - image to image 135, 267
  - steps 135, 267
  - verifying 149
- Red Mouse Linear Mapping dialog 32
- Reference GCC File dialog 277
- Region Grow icon 461, 619
- Region Grow Options dialog 461
- Region Growing Properties dialog 25, 461
- Relate Manager dialog 581
- Report Format Definition dialog 44
- Resample 9, 148, 278
  - Bilinear Interpolation 148, 278

- Cubic Convolution 148, 278
  - Nearest Neighbor 148, 278
- Resample dialog 148, 151, 279
- Reset Zoom icon 617
- Resource management 629
- RGB 39
- RGB to IHS 262
- RGB to IHS dialog 262
- RMS error 145, 624
  - residuals 624
- Roam 19
- Roam icon 21, 618, 643
- Rotate/Magnify Instructions box 120, 129
- Rotation box (rot box) 120, 122, 129
- Rule Properties dialog 507
- Rules
  - copy 512
- Rules for hypothesis 506
- Run icon 33, 224, 354, 359, 598, 633
- Run Mosaic dialog 304, 311, 322

**S**

- .sig file (signature file) 456
- Save AOI As dialog 26, 295
- Save As dialog 46
- Save icon 95, 353, 359, 597, 617, 632, 642
- Save Layer As dialog 223, 234
- Save Model dialog 353, 359, 383
- Save Options File dialog 177
- Save Signature File As dialog 468
- Save Symbology As dialog 588
- Scalar dialog 361, 634
- Scalar icon 634
- Scale 77
- Scale bar 87
- Scale Bar icon 619
- Scale Bar Instructions dialog 87
- Scale Bar Properties dialog 87
- Script model
  - annotation in 376
  - delete 375
  - edit 375



## Index

- run 375
  - Select A Directory dialog 7
  - Select Area for Zooming icon 64
  - Select icon 597, 617, 618, 633, 643
  - Select Layer To Add dialog 4, 7, 15, 20, 47, 76, 96, 104, 111, 119, 123, 129, 136, 215, 250, 256, 288, 345, 365, 456, 488, 546, 555, 559, 562, 583
  - Select Map Frame icon 619
  - Select Profile Tool dialog 47
  - Selection Criteria dialog 43, 118, 347
  - Sensor Merge 560
    - IHS 561
    - Multiplicative 561
    - Principal Component 561
  - Sensor Merge dialog 561
  - Session Log 161, 550
  - Session menu xxii, 3
  - Set Geometric Model dialog 137, 150, 270
  - Set Grid/Tick Info dialog 83
  - Set Overlap Function dialog 302, 311, 322
  - Set Parallelepiped Limits dialog 470
  - Set up scheduler 182
  - Set Window dialog 344, 383
  - Shadow
    - enhance 28
  - Shift/Bias Adjustment dialog 31
  - Shift/Bias icon 31
  - Signature
    - alarm 470
    - contingency matrix 473
    - ellipse 476
    - evaluate 468
    - feature space to image masking 474
    - histogram 477
    - merge 468
    - non-parametric 456, 481
    - parametric 456, 481
    - separability 478
    - statistics 475
  - Signature Alarm dialog 470
  - Signature Editor 456, 457
    - CellArray 596
  - Signature Objects dialog 475
  - Signature Separability dialog 478
  - SIR-A 547, 569
  - SIR-B 569
  - Site selection 629
  - Slant Range Adjustment dialog 568
  - Space resection 267
  - Spatial Enhancement menu 248
  - Spatial Modeler 239, 497
    - Library 374
  - Spatial Modeler Language 239, 341, 373
  - Spatial Modeler menu 342, 374
  - Spatial Profile viewer 50
  - Speckle noise 545
  - Spectral Enhancement menu 258
  - Spectral Profile viewer 47
  - Spectral Statistics dialog 49
  - Stacking 310
  - Statistics dialog 42, 480
  - Statistics icon 480
  - Styles dialog 85
  - Subset 240
  - Sun Positioning dialog 56
  - Supervised Classification dialog 481
  - Surface Profile viewer 52
  - Surfacing dialog 287
  - Symbol Chooser dialog 93, 121, 586
  - Symbol icon 619
  - Symbol Properties dialog 94
  - Symbology dialog 584
  - Symbols 92
- ## T
- Tab 216, 456
  - Table dialog 634
  - Table icon 634
  - Table Tool 576
    - CellArray 578
  - Tasseled Cap Coefficients dialog 259
  - Tasseled Cap dialog 258
  - Tasseled Cap transformation 258

Test Knowledge Base 514  
 Text 94
 

- align 92
- default style 94
- deselect 92
- edit 92
- fonts 91
- position 92
- style 91

 Text Editor 45, 474, 479
 

- ERDAS IMAGINE 375
- menu bar 46

 Text entry fields 98  
 Text icon 90, 619, 634  
 Text Properties dialog 92  
 Text String dialog 370, 371  
 Text Style Chooser dialog 86  
 Texture 564  
 Texture Analysis dialog 564  
 Threshold 482, 492  
 Threshold dialog 493  
 Threshold to File dialog 497  
 Tick label 85  
 Tick mark 73, 83
 

- length 84
- select 85
- spacing 84

 Tool palette
 

- AOI 294, 301, 458
- Vector 114, 122, 130

 Tools icon 23, 114, 130, 617, 633, 642  
 Tools menu xxiv, 567, 569  
 Transformation
 

- automatic calculation 146
- changing the order of 145
- coefficients 145

 Transformation matrix
 

- calculate and edit 624
- compute 145

 Transformed divergence 478

## U

Unique Value dialog 585  
 Unlink cursor 22  
 Unsupervised Classification (Isodata) dialog 102  
 Unsupervised Classification dialog 485  
 Utilities menu xxv  
 Utility menu 174

## V

Variable 204  
 Vector dialog 633  
 Vector icon 110, 574, 589, 633  
 Vector tool palette 114, 122, 130  
 Vector Utilities menu 110, 574, 576, 589  
 Vegetation classification 564  
 View Extent dialog 9  
 View Signature Columns dialog 458  
 Viewer 3
 

- Attributes 115, 125, 127
- Chip Extraction 272, 277
- Feature Space 466
- Image Drape 55
- Measurement Tool 12
- Model Maker 631
- Mosaic Tool 293, 308

 Viewer (ERDAS IMAGINE) 76, 78, 291, 365, 639
 

- AOI menu 22
- arrange layers in 15
- close 17, 22
- link 19, 150
- menu bar 6, 345, 618, 639, 640
- number allowed 639
- open new 20
- Quick View menu 150
- resize 16, 293
- source 624
- split 256
- title bar 10
- tool bar 114, 130, 639, 642
- unlink 21



## Index

Viewer Flicker dialog 107, 491, 496  
Viewer icon 123, 128, 135, 250, 292, 305,  
323, 547  
Viewshed Analysis 325  
Viewshed dialog 328, 330  
viewshed layer 329, 331  
Visual Query icon 64, 599

## W

Wallis Adaptive Filter 557  
Wallis Adaptive Filter dialog 558  
Warning box 280  
Wedge Mask dialog 230  
Wedge Mask icon 598  
Window icon 354

## Z

Zoom 16  
Zoom icon 633  
Zoom In icon 16, 618, 642  
Zoom Out icon 618, 642, 643

