



Long Term Evolution (LTE)

Long Term Evolution Advanced (LTE-A)



What is LTE ?

- In Nov. 2004, 3GPP began a project to define the long-term evolution (LTE) of Universal Mobile Telecommunications System (UMTS) cellular technology
 - Higher performance
 - Backwards compatible
 - Wide application



Standards organizations and other related bodies have agreed to co-operate for the production of **a complete set of globally applicable Technical Specifications** for a 3rd Generation Mobile System based on the **evolved GSM** core networks and the radio access technologies supported by 3GPP partners (i.e., UTRA both FDD and TDD modes).

The Project is entitled the “Third Generation Partnership Project” and may be known by the acronym “3GPP”.

3GPP has been established for the preparation and maintenance of the above mentioned Technical Specifications, and is not a legal entity.



3GPP comprises of:

- Partners:
 - Organizational Partners
 - 3GPP is open to all standards organizations irrespective of the geographical location.
 - Market Representation Partners
- Individual Members



3GPP is characterized by the following attributes:

- **Minimum production time** for Technical Specifications from conception to approval
- Fast, **electronic based approval** process
- Maximum use of **modern (electronic) working methods**
- **Minimum number of hierarchical levels** with decision making taking place at the lowest appropriate levels



Internal structure of 3GPP

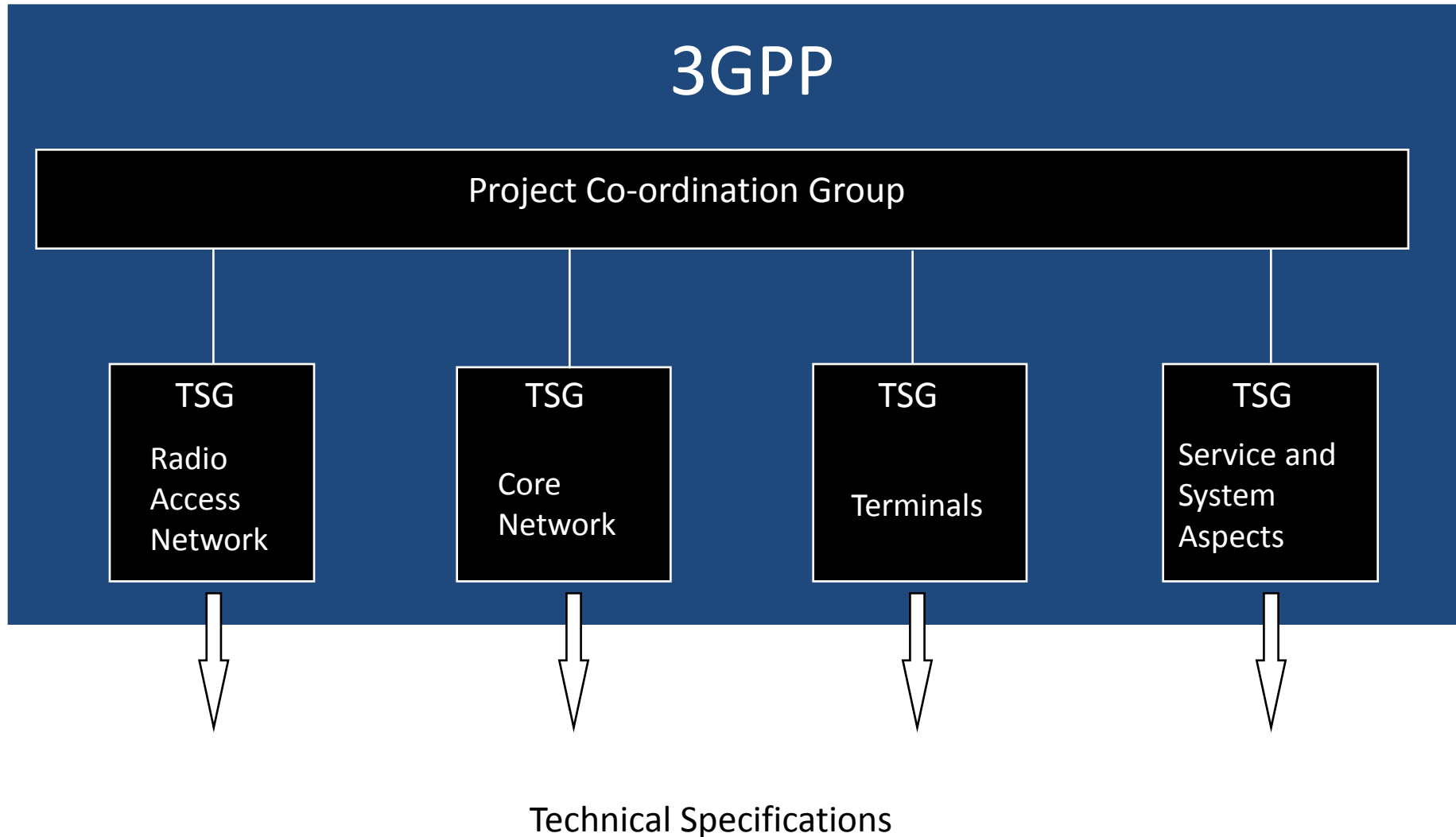



3GPP meetings





- **ARIB**

The Association of Radio Industries and Businesses, Japan

- **ATIS**

The Alliance for Telecommunications Industry Solutions, USA

- **CCSA**

China Communications Standards Association

- **ETSI**

The European Telecommunications Standards Institute

- **TTA**

Telecommunications Technology Association, Korea

- **TTC**

Telecommunication Technology Committee, Japan





Evolution of Radio Access Technologies

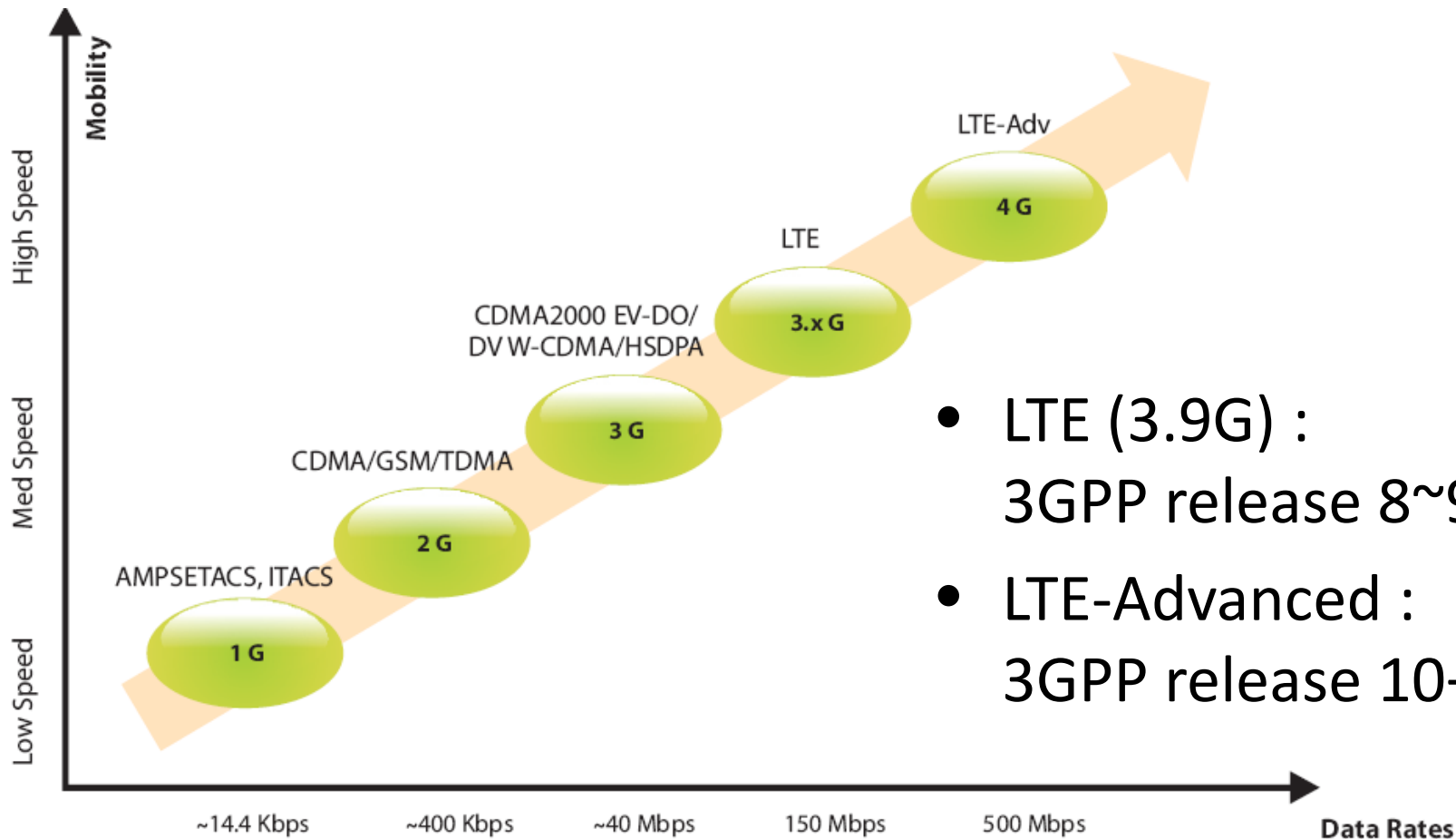



2G (GSM)



GSM

- Abbreviation for **Global System for Mobile Communications**
- In the mid 1980's, most of Europe didn't have a cellular network
 - They weren't committed to analog
- After many years of research, GSM was proposed around 1990
 - Covered Germany, France, England, and Scandinavia
 - In Greece GSM started in 1993
- Goals:
 - Roaming throughout all of Europe
 - Low power and inexpensive devices
 - All digital to offer 64kbps throughput
 - Never achieved



GSM Services

- Voice, 3.1 kHz
- Some data transmission is possible with **very low speeds** (originally 9.6kbps) – e.g. fax.
- Short Message Service (SMS)
 - 1985 GSM standard that allows messages of at **most 160 chars** (incl. spaces) to be sent between handsets and other stations
 - SMS is the most widely used data application in the world, with **3.6 billion active users**, or 78% of all mobile phone subscribers (2011).

GSM Frequencies

- Originally designed on **900MHz range**, later available on **800MHz, 1800MHz and 1900 MHz** ranges.
- Separate Uplink and Downlink frequencies
 - One example channel on the 1800 MHz frequency band, where RF carriers are spaced every 200 kHz

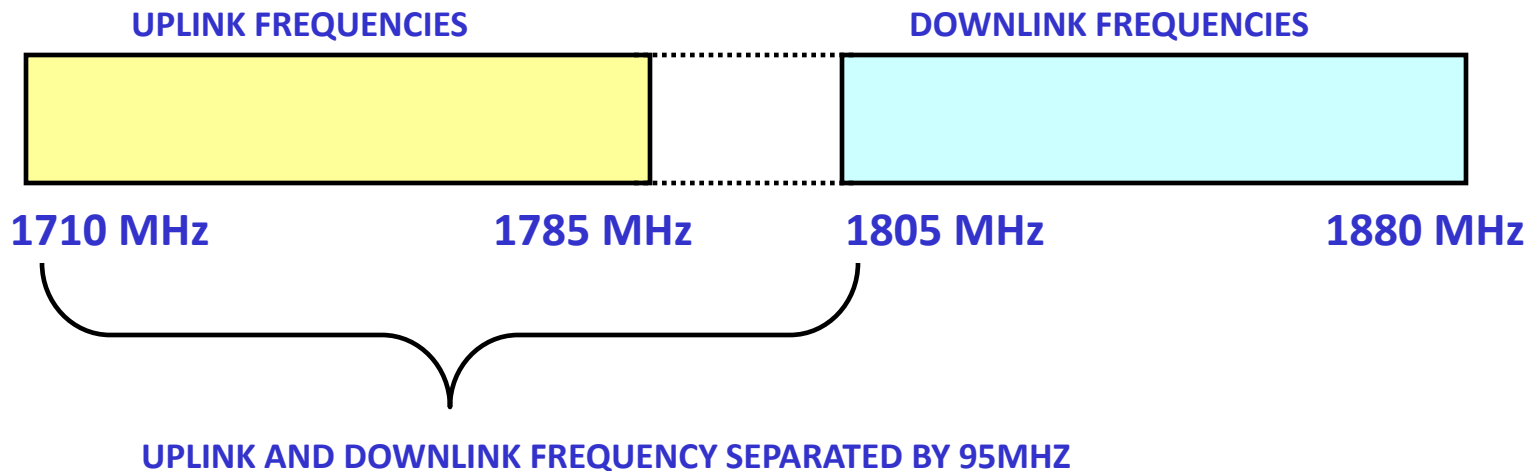



Uplink/Downlink frequency channels

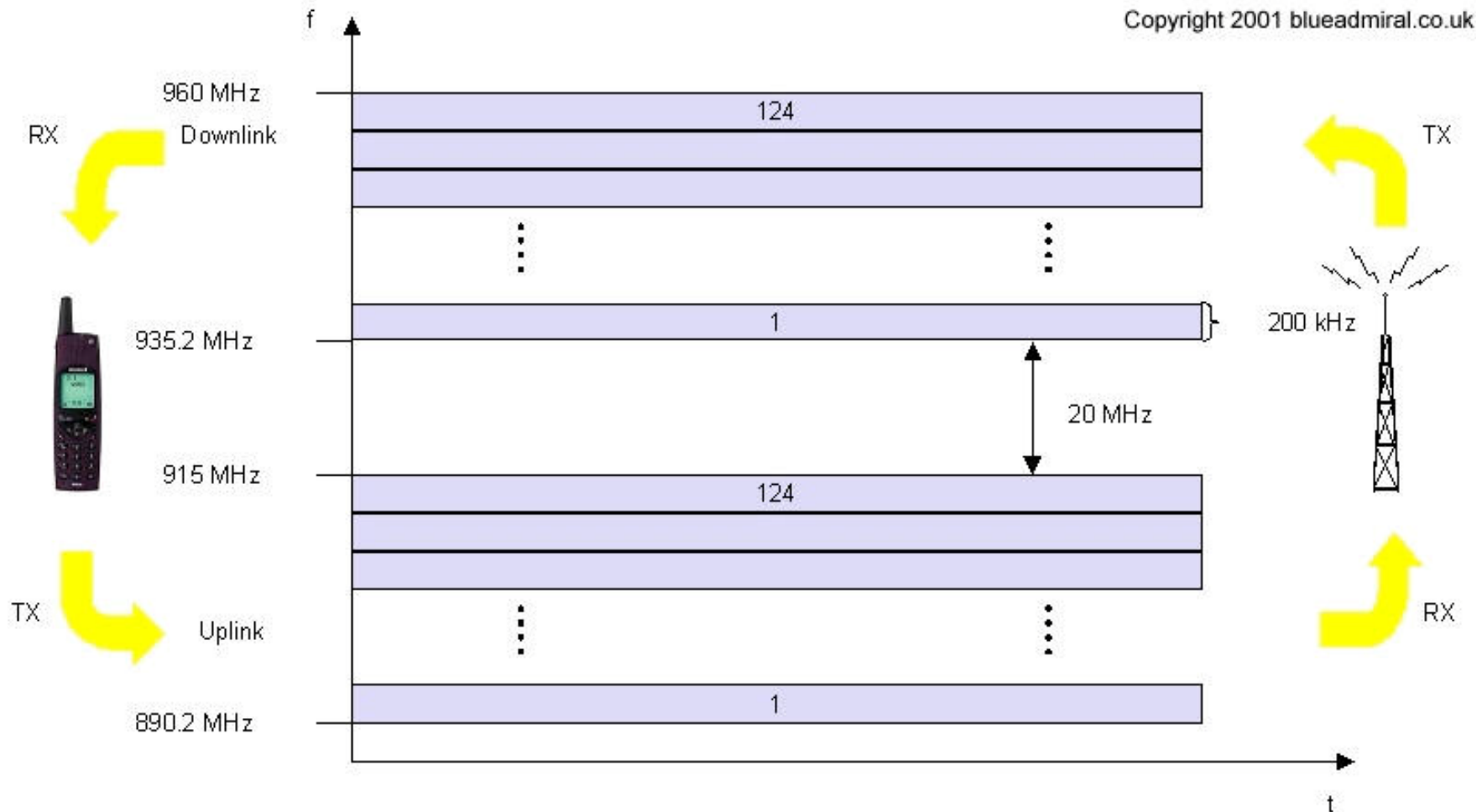



GSM resource allocation

Copyright 2001 blueadmiral.co.uk

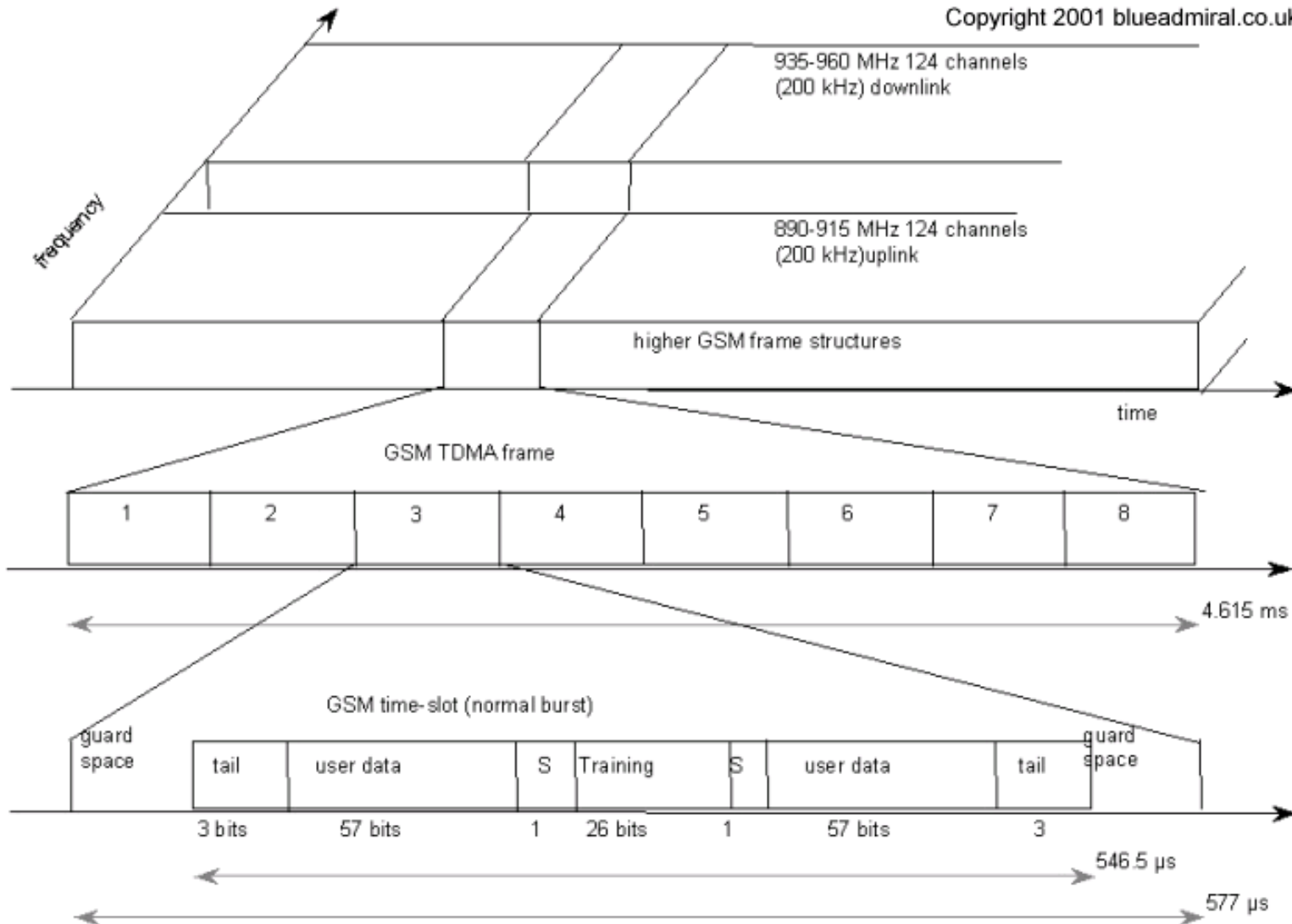



GSM System – Multiple Access

Time Division Multiple Access (TDMA)

992 voice channels/cell

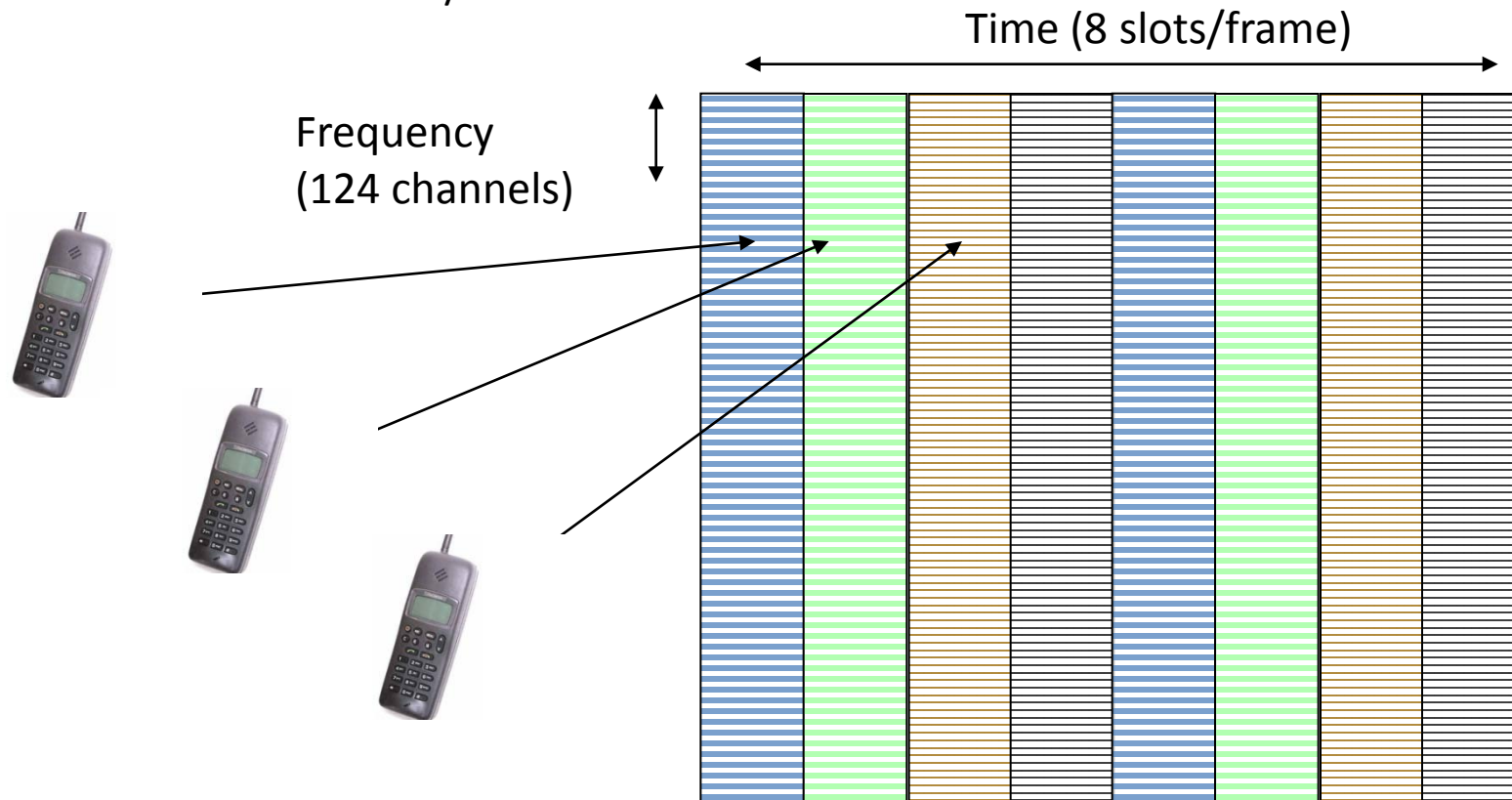



GSM architecture

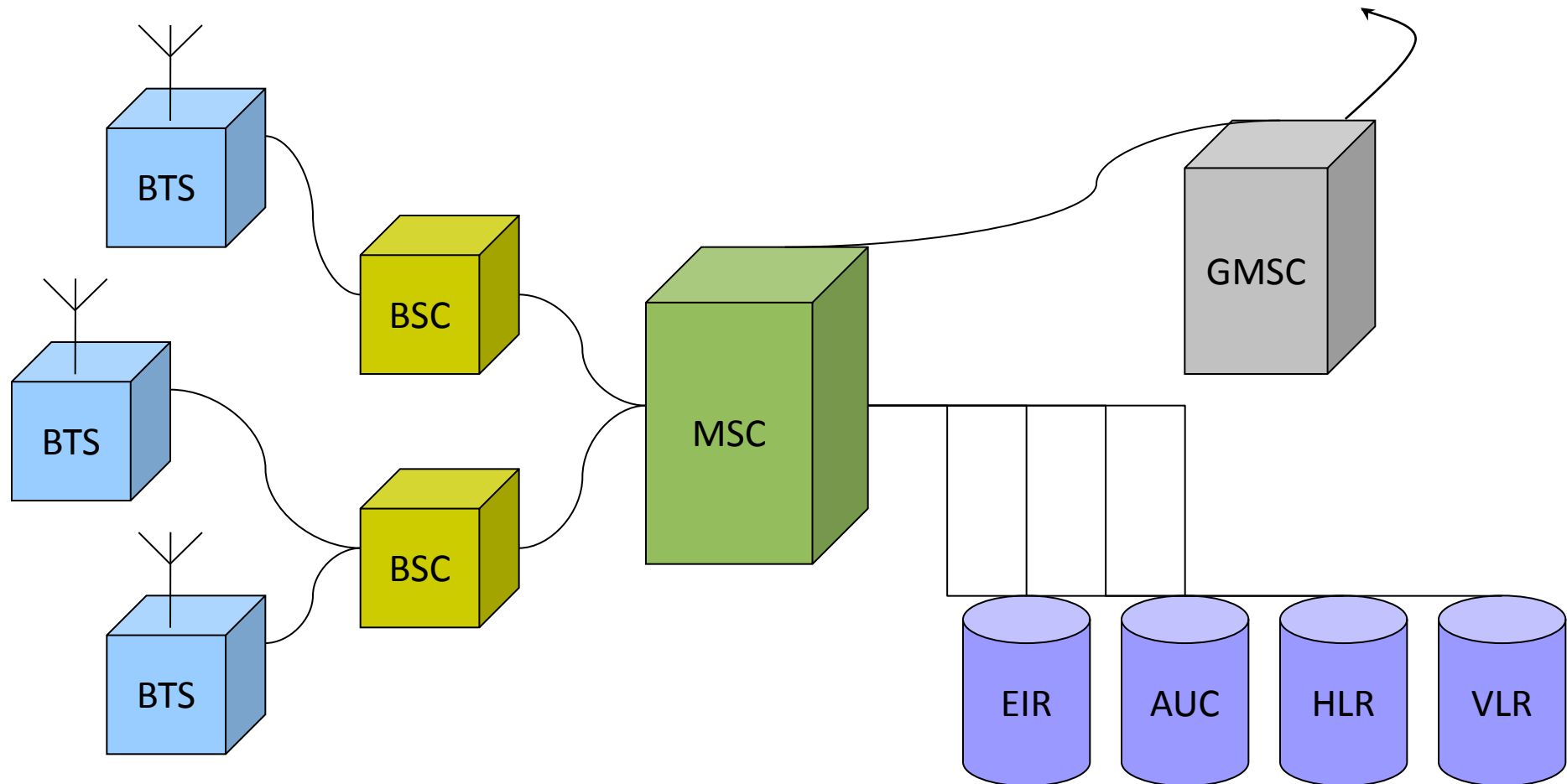



GSM main components

Base Transceiver Station (BTS): Encodes, encrypts, multiplexes, modulates and feeds the **RF signals to the antenna**.

Base Station Controller (BSC): **Manages Radio resources for BTSs**, assigns frequency and time slots for all mobile terminals in its area.

Mobile Switching Center (MSC): **Heart of the network**, call setup function and basic switching, call routing, billing information and collection, mobility management.

Home/Visiting Location Registers (HLR/VLR): permanent/temporary **database about mobile subscribers** in a large service area.

Authentication Center (AUC): Protects against intruders in air interface, maintains **authentication keys and algorithms**.

Equipment Identity Register (EIR): Database that is used to **track handsets** using the IMEI (International Mobile Equipment Identity).



GPRS (General Packet Radio Service)

- GSM upgrade that provides IP-based packet **data transmission up to 171 kbps (never allowed)**
- Users can “simultaneously” make **calls and send data**
- GPRS provides “always on” **Internet access and the Multimedia Messaging Service (MMS)**
- Performance degrades as number of users increase
- GPRS is an example of 2.5G telephony



GPRS Architecture

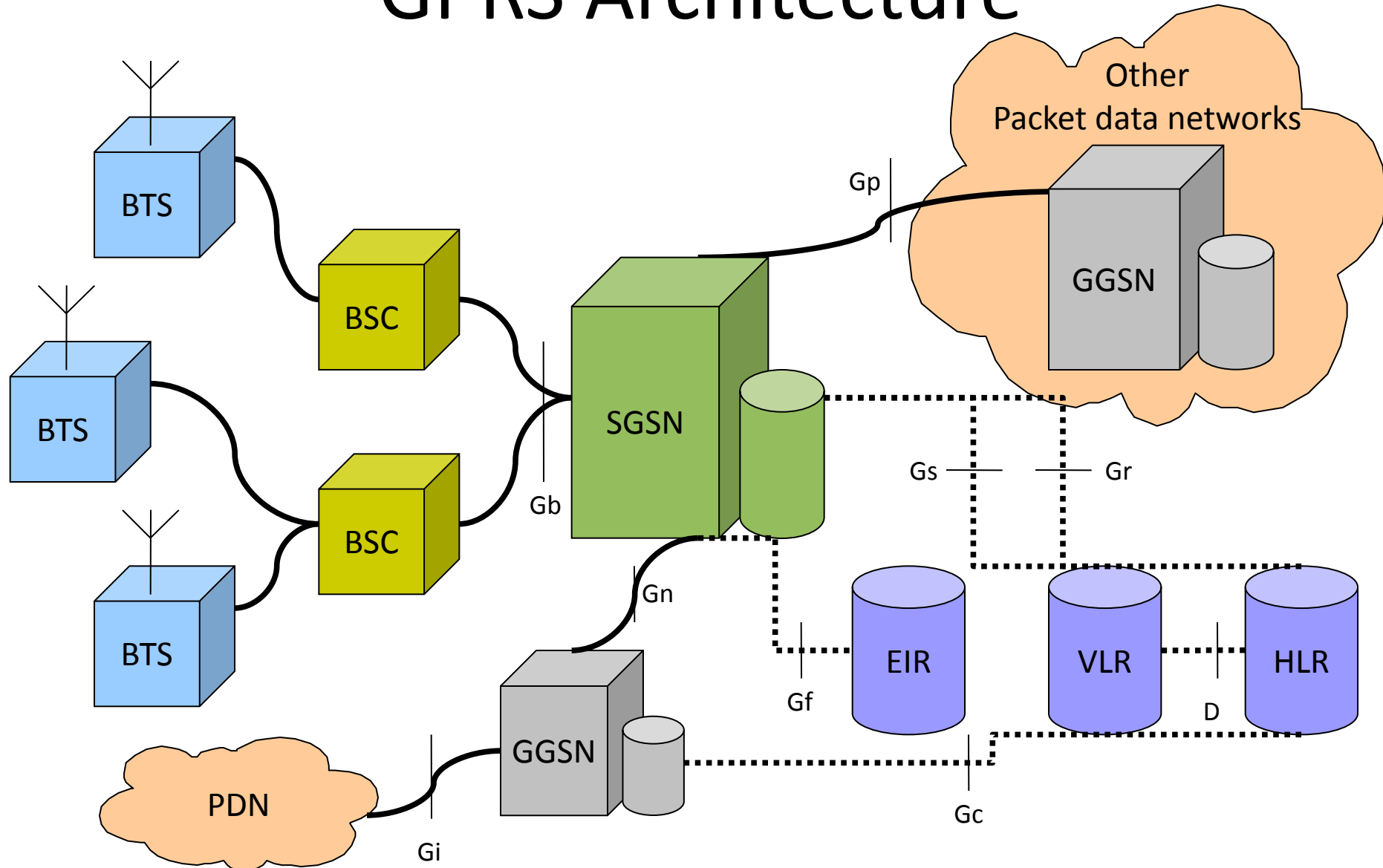



Main difference with GSM

SGSN (Serving GPRS Support Node): Packet switching with mobility management capabilities. Responsible for the **delivery of data packets from and to the mobile stations** within its geographical service area.

GGSN (Gateway GPRS Support Node): Packet switch **interworking with other data networks** (Internet). Converts the GPRS packets coming from the SGSN into the appropriate packet data protocol format (e.g., IP)

Routing in GPRS

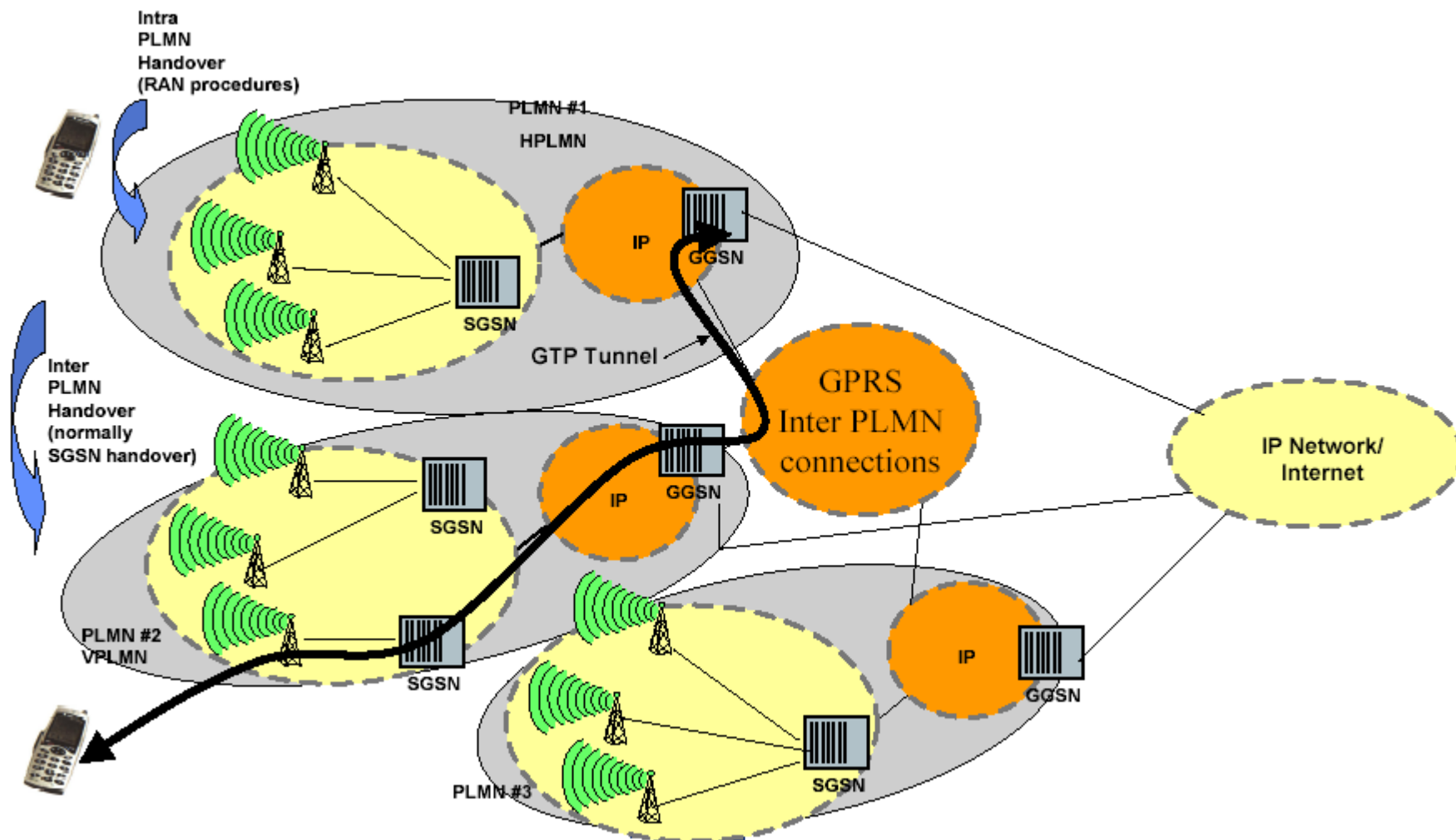



GPRS System – Multiple Access

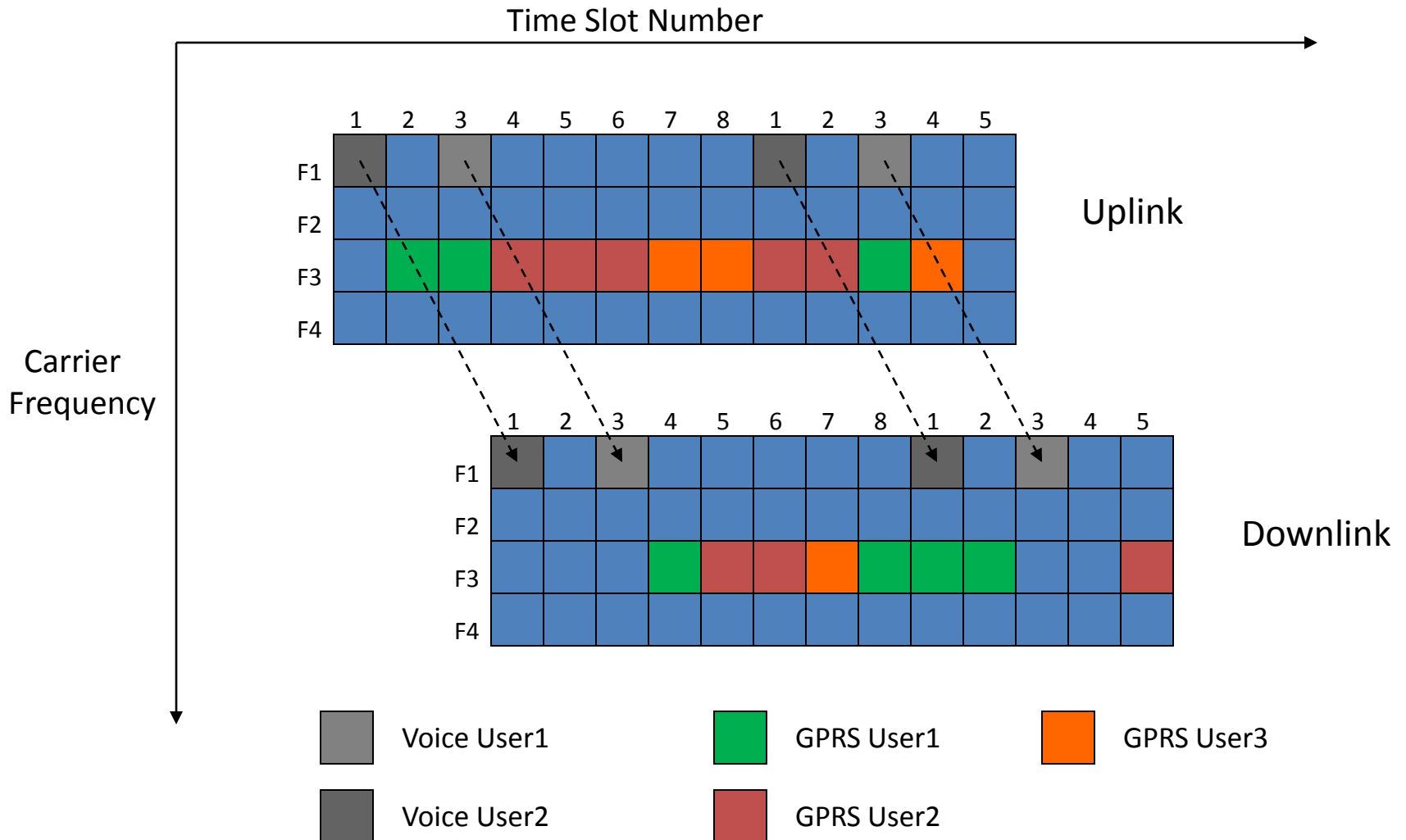



3G

- 3G refers to a **set of standards** that comply to IMT-2000 specifications by ITU
- The following standards are typically branded 3G:
 - the **UMTS system**, first offered in 2001, standardized by **3GPP**, used primarily in Europe
 - the **CDMA2000** system, first offered in 2002, standardized by **3GPP2**, used especially in North America



IMT-2000 Vision Includes LAN, WAN and Satellite Services

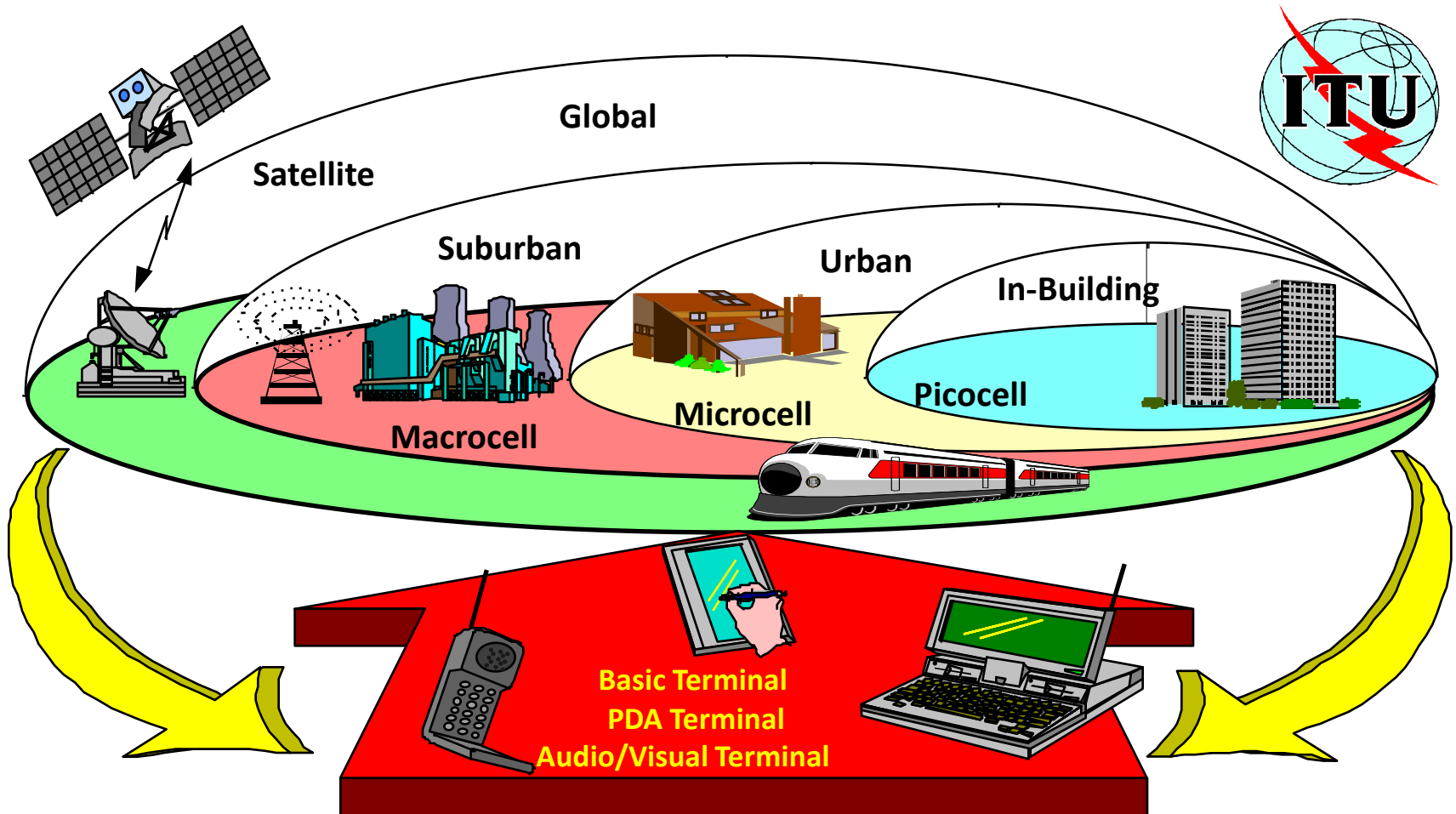



UMTS (Universal Mobile Telecommunications System)

- Voice quality comparable to the **public switched telephone** network
- **144 Kbps/user** in high-speed motor vehicles
- **384 Kbps/pedestrian** standing or moving slowly over small areas
- **Up to 2 Mbps** for fixed applications like office use
- Symmetrical/asymmetrical data transmission rates
- Support for both **packet switched and circuit switched data** services like Internet Protocol (IP) traffic and real time video

UMTS Frequency Spectrum

- UMTS Band
 - 1900-2025 MHz and 2110-2200 MHz for 3G transmission
 - In the US, 1710–1755 MHz and 2110–2155 MHz is used instead, as the 1900 MHz band was already used.

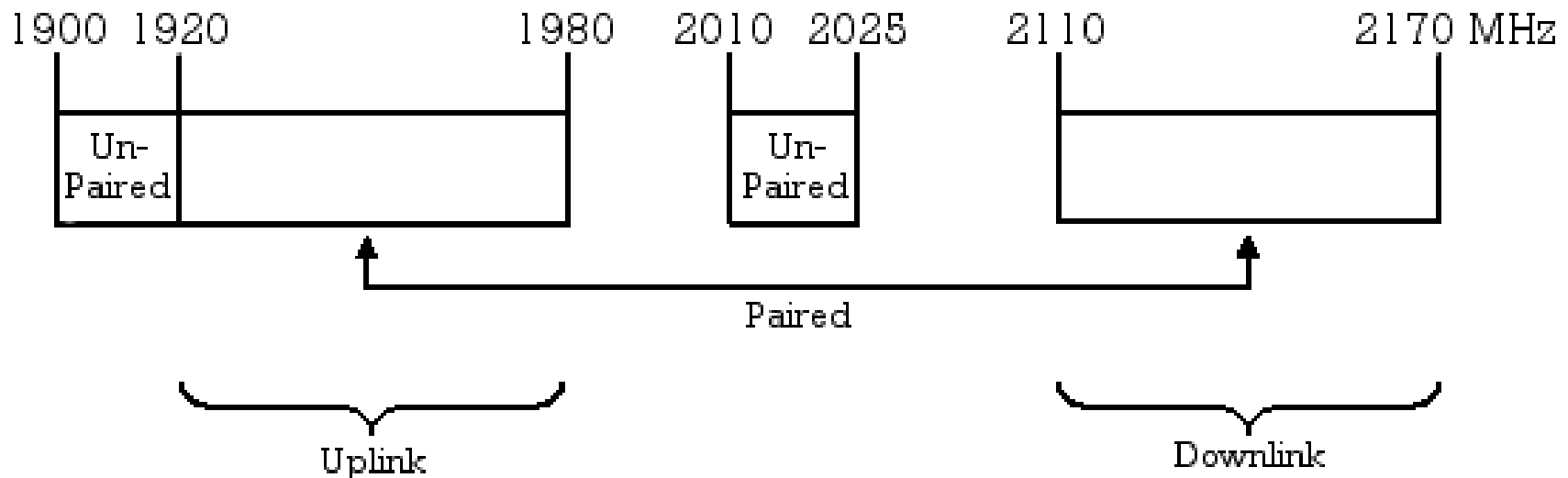

UMTS Architecture

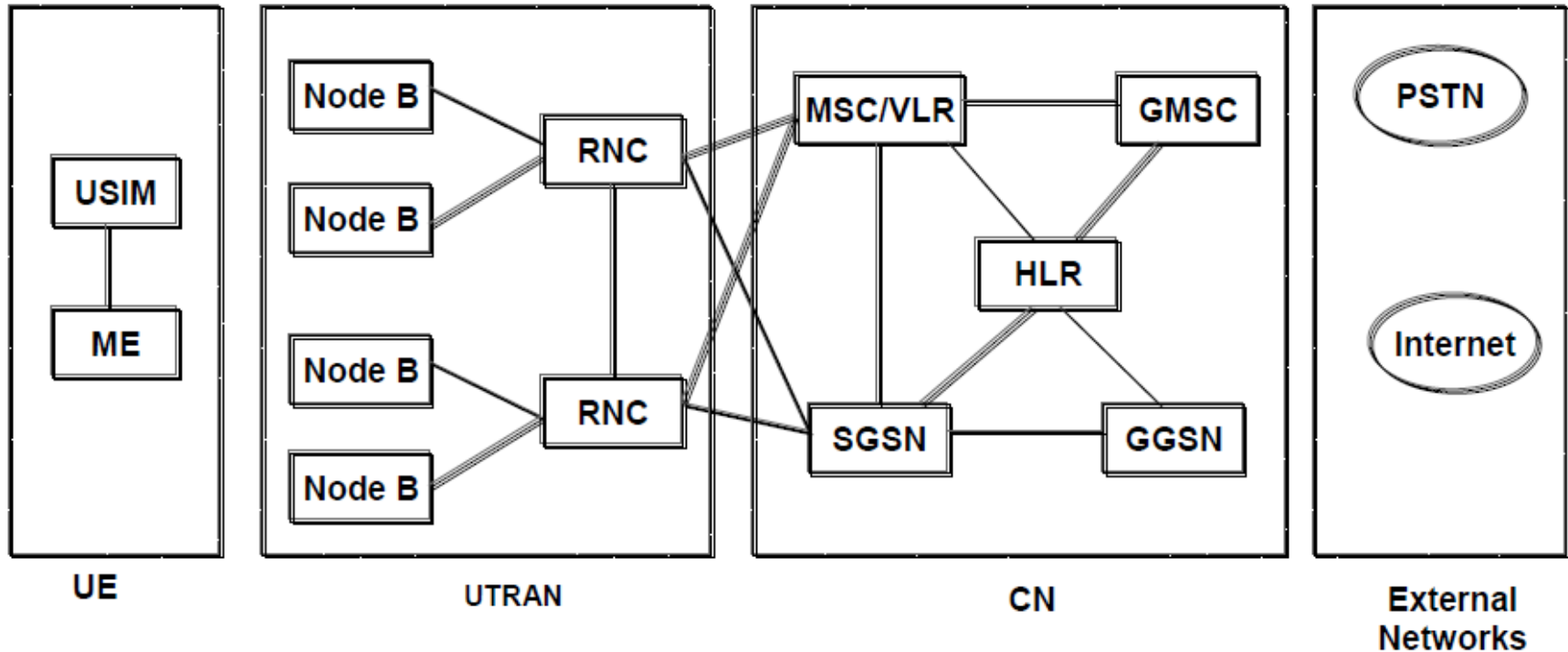

- UE (User Equipment) that interfaces with the user
- UTRAN (UMTS Terrestrial Radio Access Network) handles all radio related functionality – WCDMA is radio interface standard here.
- CN (Core Network) is responsible for transport functions such as switching and routing calls and data, tracking users



UMTS Network Architecture

- UMTS network architecture consists of three domains
 - **Core Network (CN)**: Provide switching, routing and transit for user traffic
 - **UMTS Terrestrial Radio Access Network (UTRAN)**: Provides the air interface access method for user equipment.
 - **User Equipment (UE)**: Terminals work as air interface counterpart for base stations.



UMTS Bearer Services

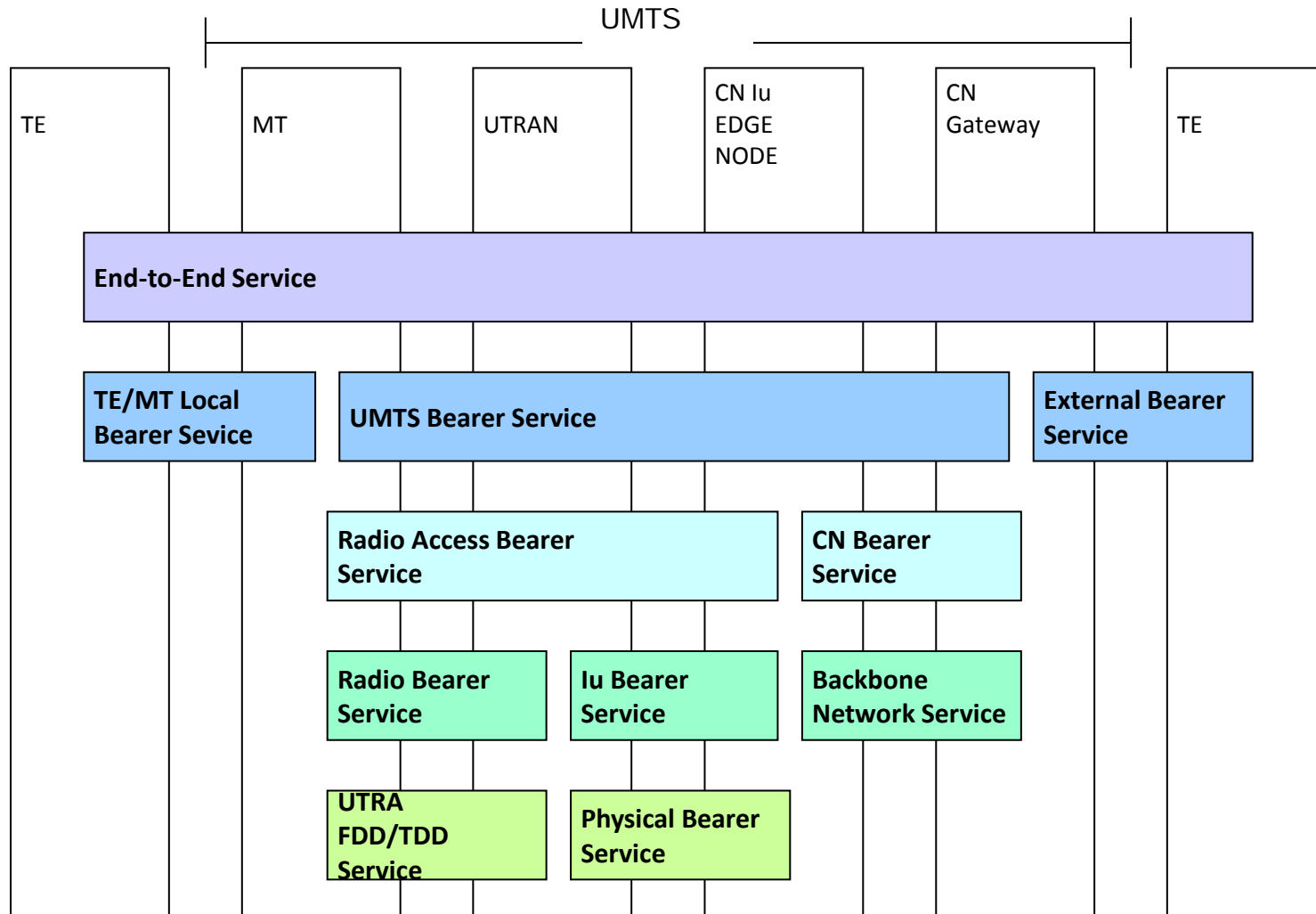



UMTS QoS Classes

Traffic class	Conversational class	Streaming class	Interactive class	Background
Fundamental characteristics	Preserve time relation between information entities of the stream Conversational pattern (stringent and low delay)	Preserve time relation between information entities of the stream	Request response pattern Preserve data integrity	Destination is not expecting the data within a certain time Preserve data integrity
Example of the application	Voice, videotelephony, video games	Streaming multimedia	Web browsing, network games	Background download of emails



UMTS In Detail

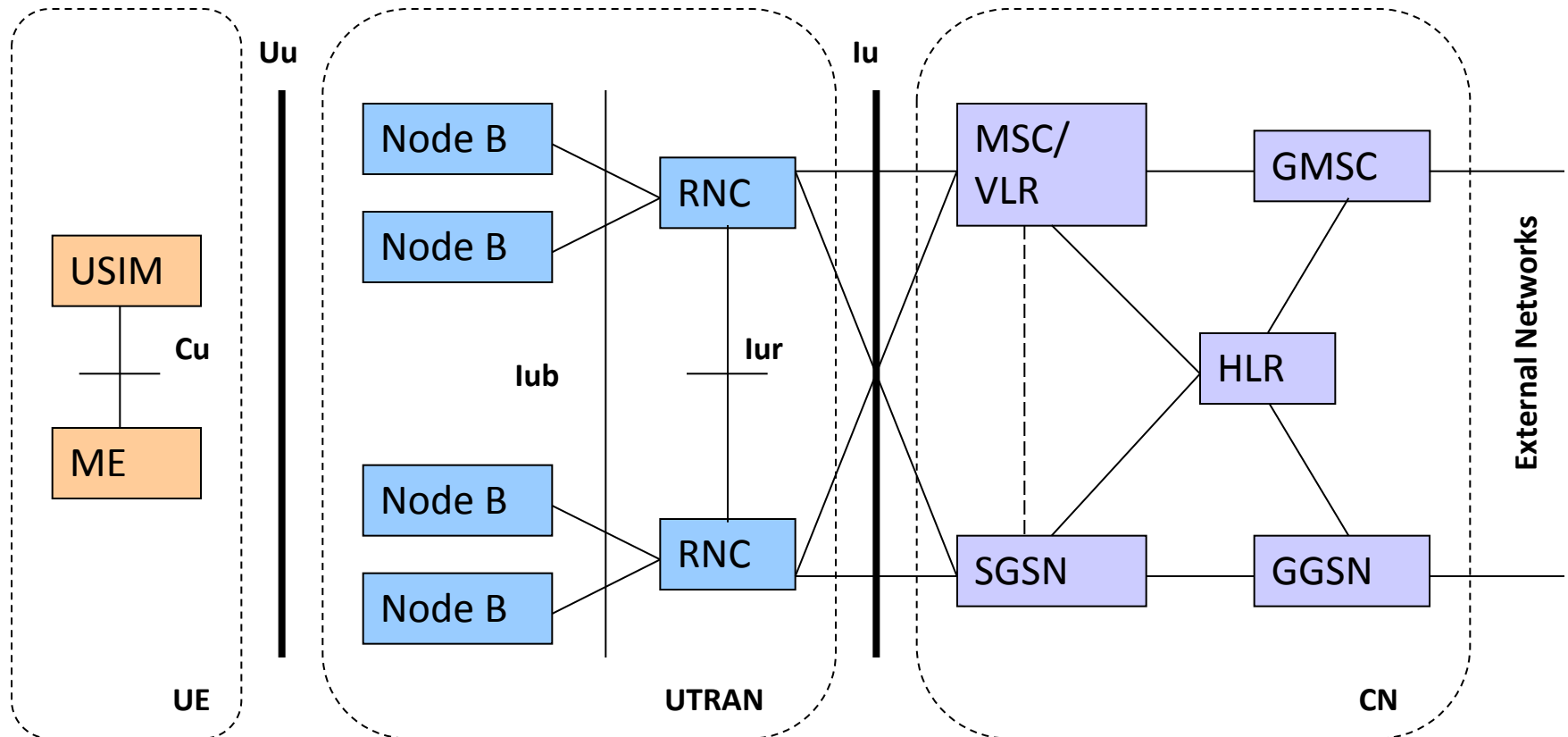

UTRAN: Different types of channels

- Paging Channel (PCH)
- Forward Link Access Channel (FACH)
- Random Access Channel (RACH)
- Uplink Common Packet Channel (CPCH)
- Downlink Shared Channel (DSCH)

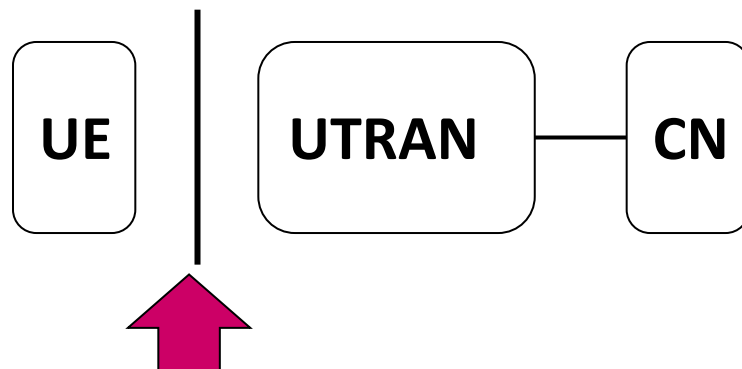



UTRAN

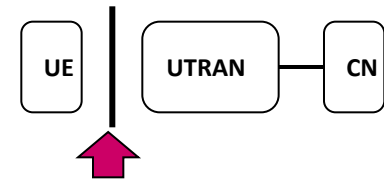

Common Channels - RACH (uplink) and FACH (downlink)

- Random Access, No Scheduling
- Low Setup Time
- No Feedback Channel, No Fast Power Control, Use Fixed Transmission Power
- Poor Link-level Performance and Higher Interference
- Suitable for Short, Discontinuous Packet Data

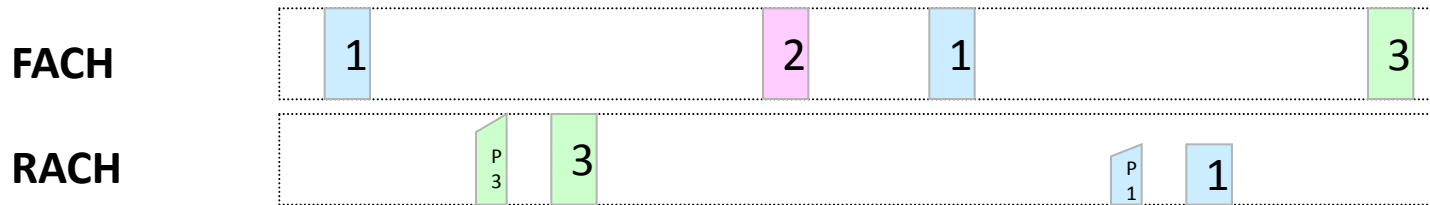

Common Channel - CPCH (uplink)

- Extension for RACH
- Reservation across Multiple Frames
- Can Utilize Fast Power Control, Higher Bit Rate
- Suitable for Short to Medium Sized Packet Data



UTRAN

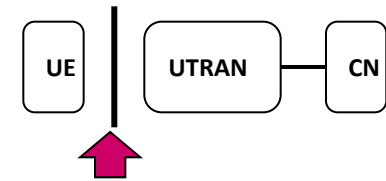

Dedicated Channel - DCH (uplink & downlink)

- Dedicated, Requires Long Channel Setup Procedure
- Utilizes Fast Power Control
- Better Link Performance and Smaller Interference
- Suitable for Large and Continuous Blocks of Data, up to 2Mbps
- Variable Bitrate in a Frame-by-Frame Basis

DCH (User 1)



DCH (User 2)



Shared Channel - DSCH (downlink)

- Time Division Multiplexed, Fast Allocation
- Utilizes Fast Power Control
- Better Link Performance and Smaller Interference
- Suitable for Large and Bursty Data, up to 2Mbps
- Variable Bitrate in a Frame-by-Frame Basis

DSCH

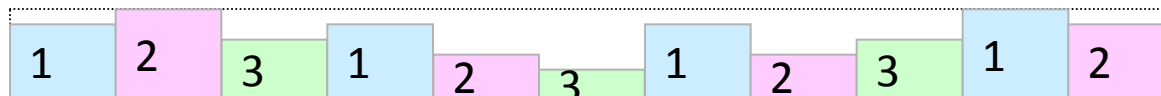

Core Network

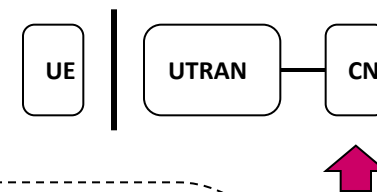

○ CS Domain :

- Mobile Switching Centre (MSC)
 - Switching CS transactions
- Visitor Location Register (VLR)
 - Holds a copy of the visiting user's service profile, and the precise info of the UE's location
- Gateway MSC (GMSC)
 - The switch that connects to external networks

○ PS Domain :

- Serving GPRS Support Node (SGSN)
 - Similar function as MSC/VLR
- Gateway GPRS Support Node (GGSN)
 - Similar function as GMSC

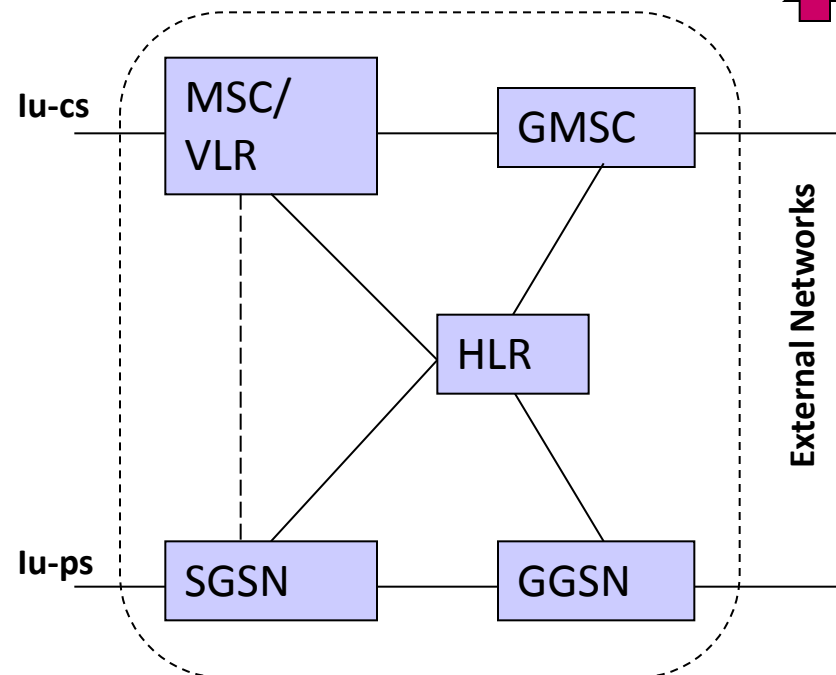

○ Register :

- Home Location Register (HLR)
 - Stores master copies of users service profiles
 - Stores UE location on the level of MSC/VLR/SGSN

UTRAN

- **Wide band CDMA** technology is selected for UTRAN air interface (instead of FDMA/TDMA in GSM and GPRS)
- Advanced **mobility support** (e.g., soft handover)

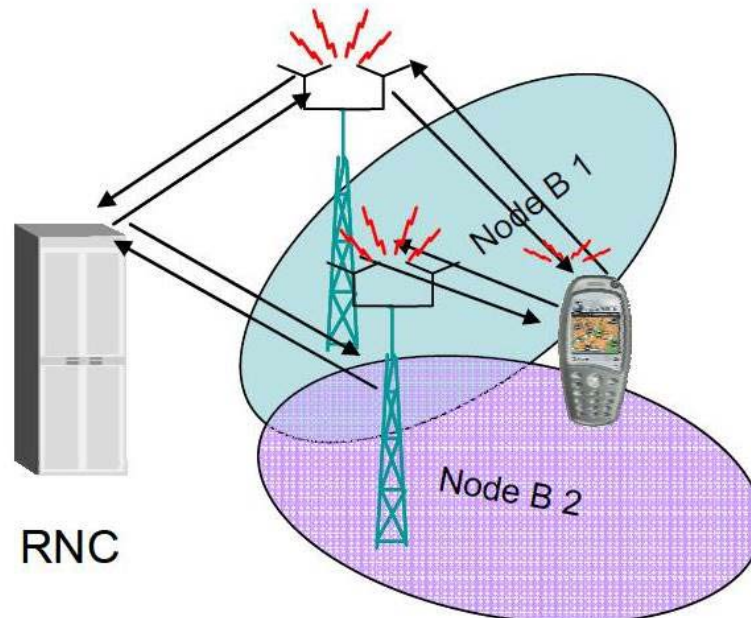



3.5G (HSPA)

High Speed Packet Access (HSPA) is an amalgamation of two mobile telephony protocols, High Speed Downlink Packet Access (**HSDPA**) and High Speed Uplink Packet Access (**HSUPA**), that extends and improves the performance of existing WCDMA protocols

3.5G introduces many new features that enhance the UMTS technology. These include:

- Adaptive Modulation and Coding
- Fast Scheduling
- Backward compatibility with 3G
- Enhanced Air Interface



Service Roadmap

Improved performance, decreasing cost of delivery

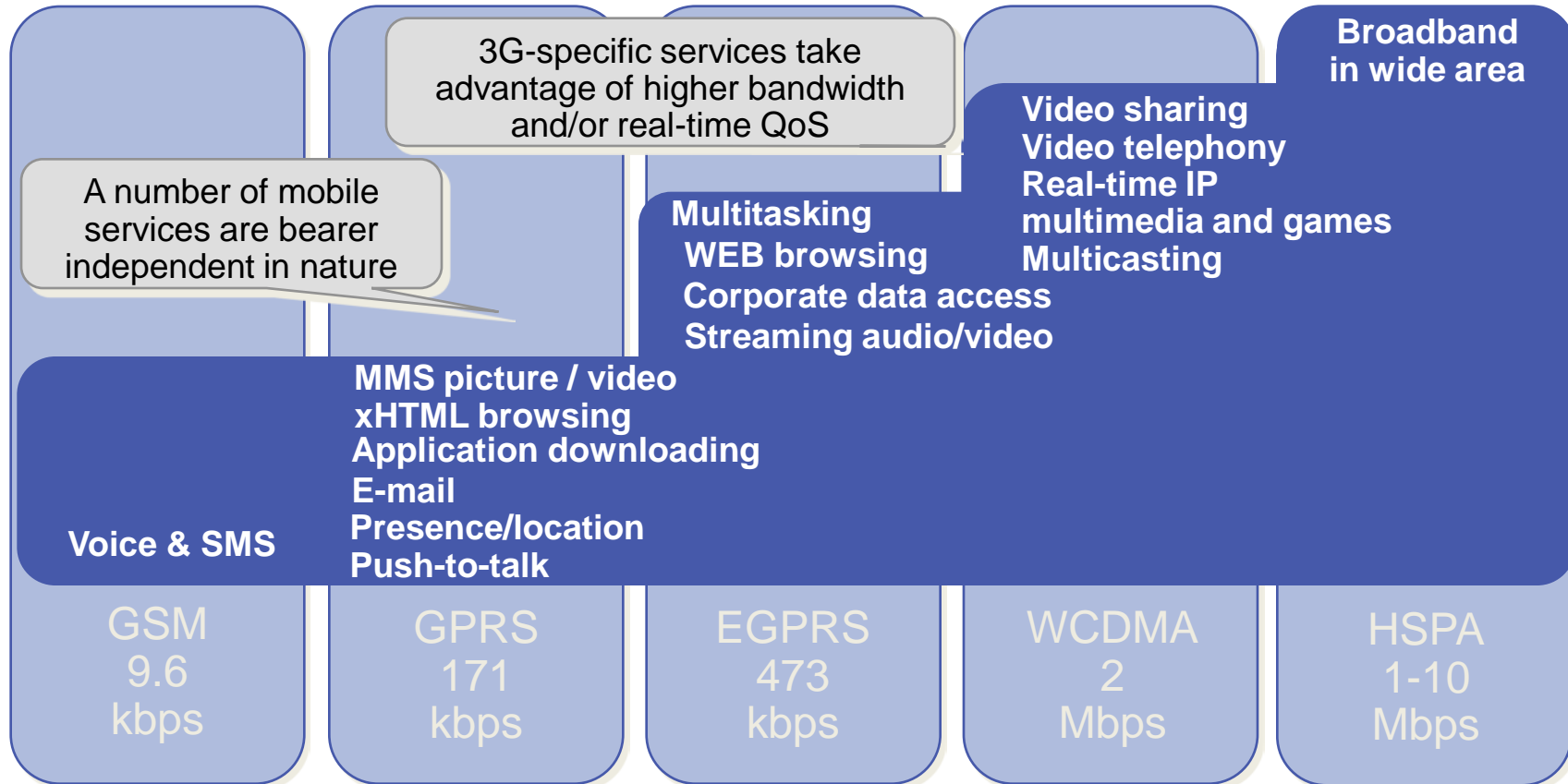
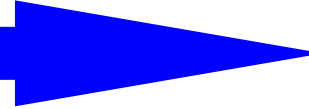

LTE - Towards 4G

- LTE stands for **Long Term Evolution** (... of UMTS)
- Next Generation mobile broadband technology
- Promises data transfer rates of 100 Mbps
- Based on UMTS 3G technology
- Optimized for All-IP traffic

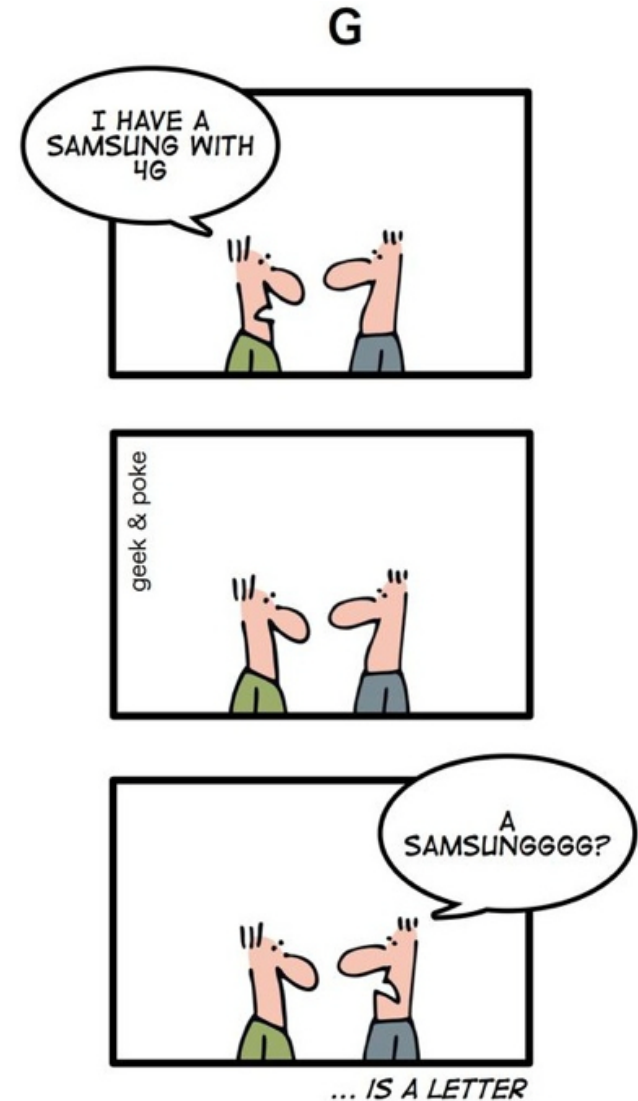



Motivation for LTE

- Need for higher data rates and greater spectral efficiency
 - Can be achieved with HSDPA/HSUPA
 - and/or new air interface defined by 3GPP LTE
- Need for Packet Switched optimized system
 - Evolve UMTS towards packet only system
- Need for high quality of services
 - Use of licensed frequencies to guarantee quality of services
 - Always-on experience (reduce control plane latency significantly)
 - Reduce round trip delay
- Need for cheaper infrastructure
 - Simplify architecture, reduce number of network elements



Advantages of LTE

- ▶ High network throughput
- ▶ Low latency
- ▶ Plug & Play architecture
- ▶ Low Operating Costs
- ▶ All-IP network
- ▶ Simplified upgrade path from 3G networks

for Network Operators

- ▶ Faster data downloads/uploads
- ▶ Improved response for applications
- ▶ Improved end-user experience

for End Users



Comparison of LTE Speed

2G – 4G Data download rates

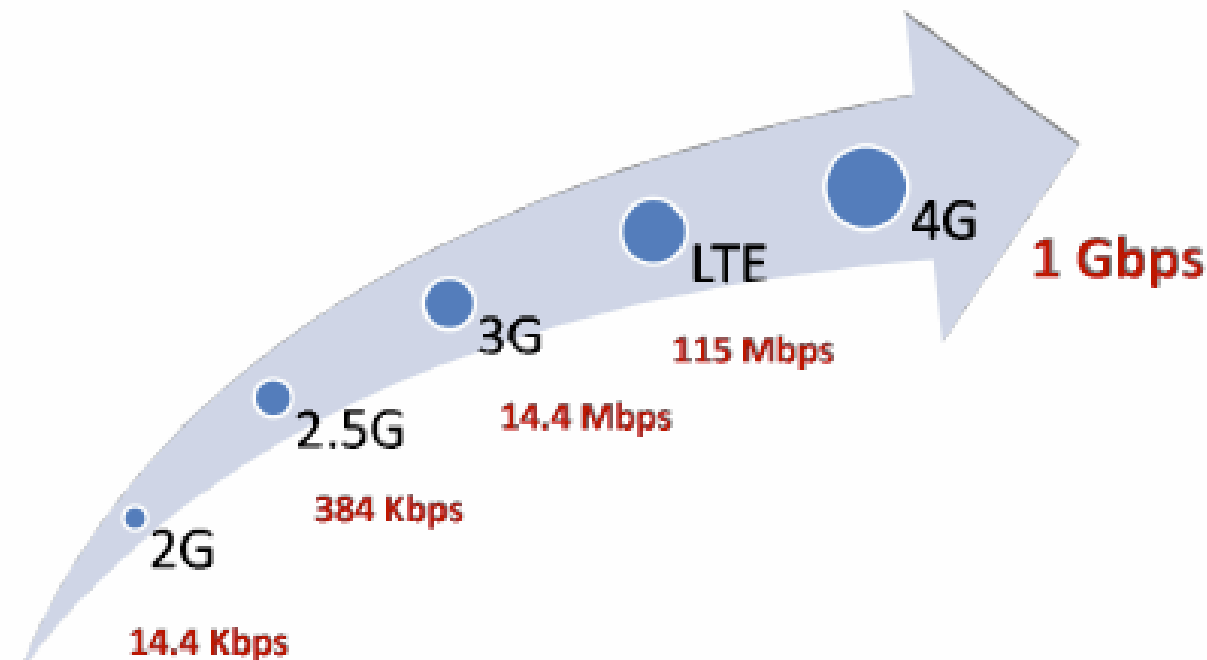

• 2.5G speed is based on the maximum offered by EDGE

• 3G speed is based on the maximum offered by HSDPA



Data traffic growth forecast

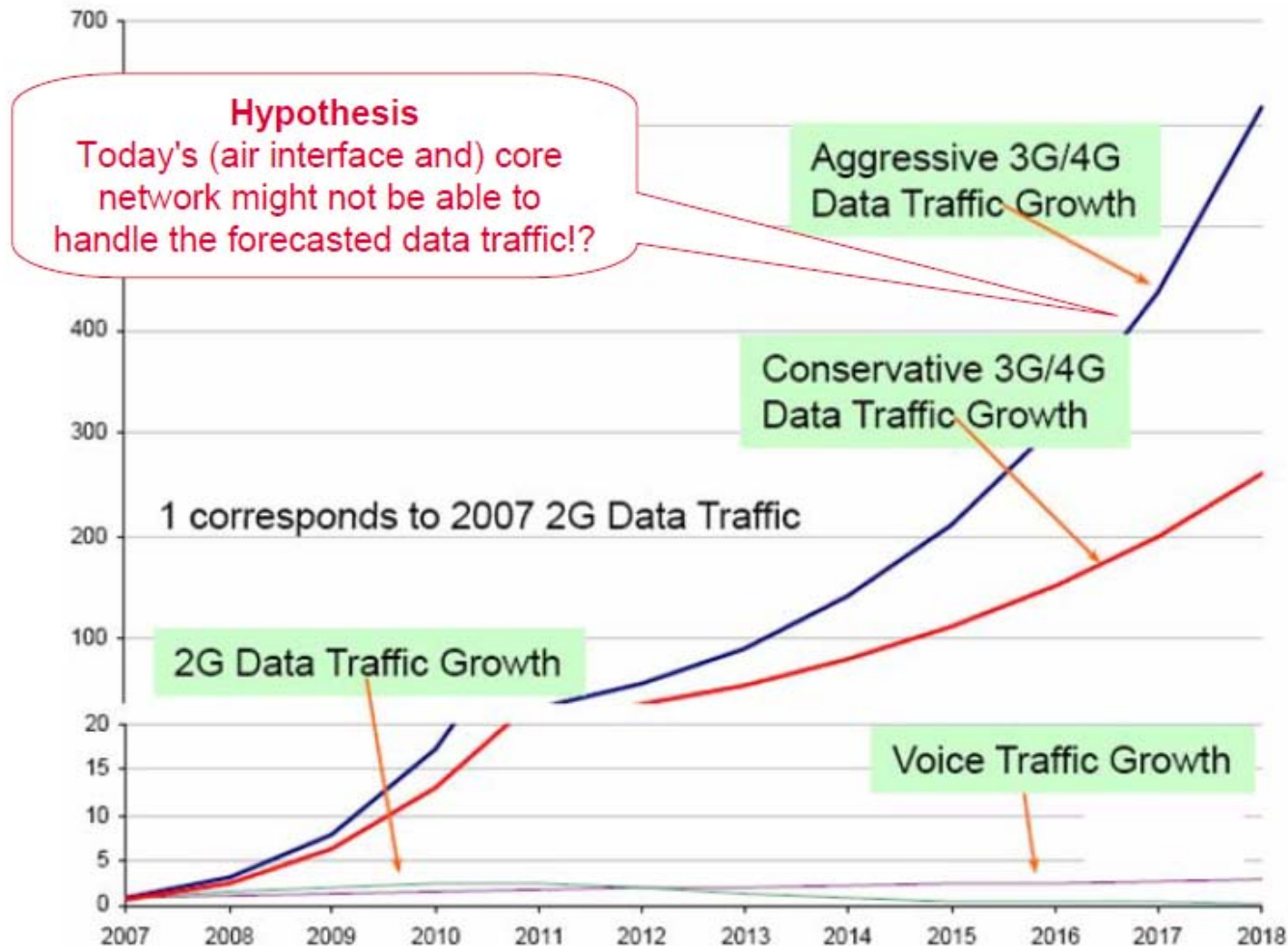

Towards an All-IP Fixed-Mobile Network

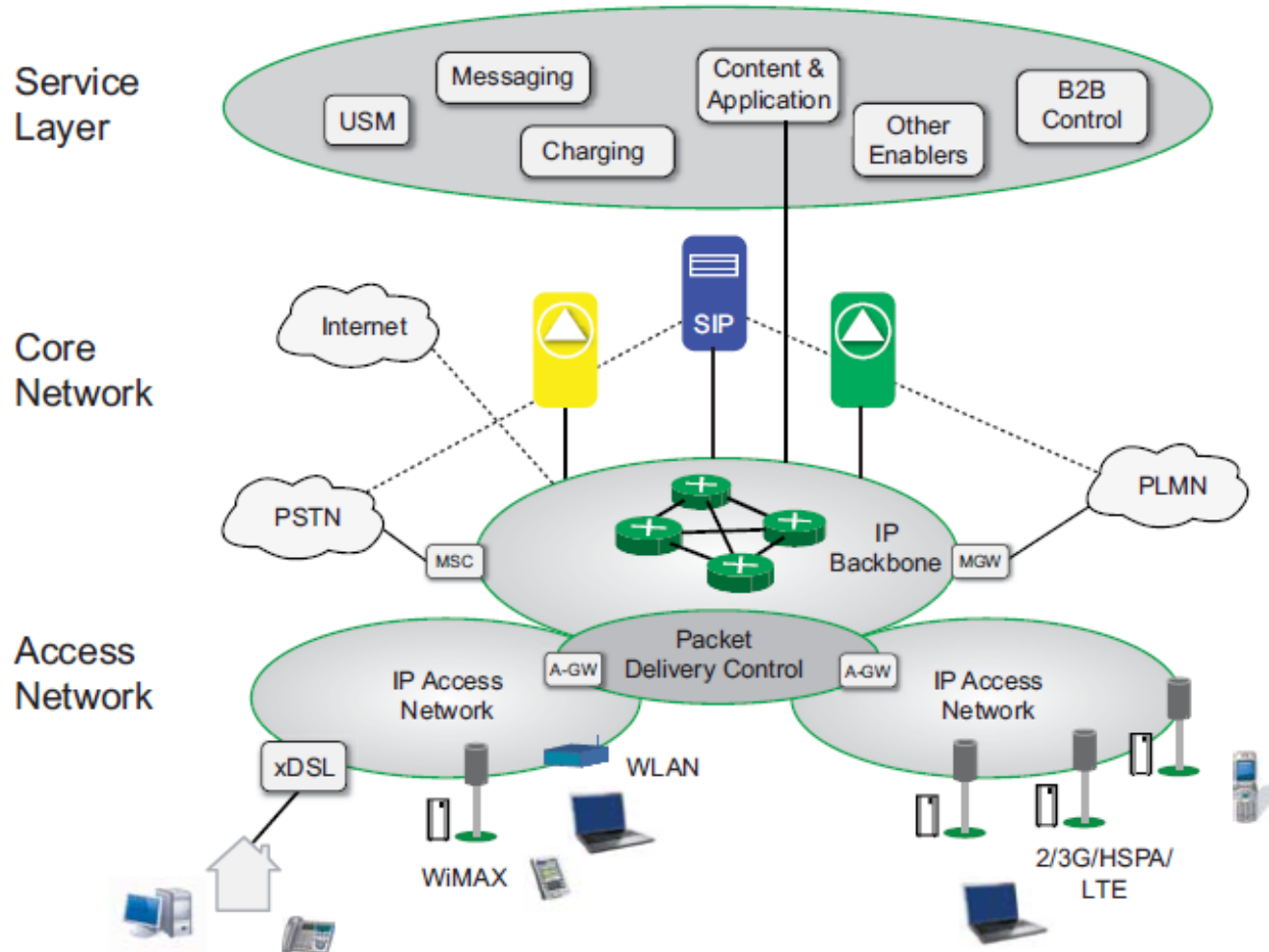



LTE Evolution

- Specification managed by 3GPP organization
 - 3rd Generation Partnership Project
 - UMTS (Universal Mobile Telephone System) Rel 99
 - HSDPA (High Speed Downlink Packet Access) Rel 5
 - HSUPA (High Speed Uplink Packet Access) Rel 6
 - HSPA+ Rel 7, enhancements in Rel 8-10
- New LTE specification in Release 8-9
- LTE-A in Release 10



	WCDMA (UMTS)	HSPA HSDPA / HSUPA	HSPA+	LTE	LTE ADVANCED (IMT ADVANCED)
Max downlink speed (bps)	384k	14 M	28 M	100 M	1 G
Max uplink speed (bps)	128 k	5.7 M	11 M	50 M	500 M
Latency round trip time (approx.)	150 ms	100 ms	50 ms (max)	~10 ms	Less than 5 ms
3GPP releases	Rel 99/4	Rel 5/6	Rel 7	Rel 8/9	Rel 10
Approx years of initial roll out	2003/4	2005/6 HSDPA 2007/8 HSUPA	2008/9	2009/10	
Access methodology	CDMA	CDMA	CDMA	OFDMA/SC- FDMA	OFDMA/SC- FDMA



LTE performance requirements

- **Data Rate:**
 - Instantaneous downlink peak data rate of 100Mbit/s in a 20MHz downlink spectrum (i.e. 5 bit/s/Hz)
 - Instantaneous uplink peak data rate of 50Mbit/s in a 20MHz uplink spectrum (i.e. 2.5 bit/s/Hz)
- **Cell range**
 - 5 km - optimal size
 - 30km sizes with reasonable performance
 - up to 100 km cell sizes supported with acceptable performance
- **Cell capacity**
 - up to 200 active users per cell(5 MHz) (i.e., 200 active data clients)



LTE performance requirements

- Mobility
 - Optimized for low mobility(0-15km/h) but supports high speed
- Latency
 - user plane < 5ms
 - control plane < 50 ms
- Improved spectrum efficiency
- Improved broadcasting
- IP-optimized
- Scalable bandwidth of 20, 15, 10, 5, 3 and 1.4MHz
- Co-existence with legacy standards



Key parameters of LTE

Frequency Range	UMTS FDD bands and UMTS TDD bands					
Channel bandwidth 1 Resource Block (RB) =180 kHz	1.4 MHz	3 MHz	5 MHz	10 MHz	15 MHz	20 MHz
	6 RB	15 RB	25 RB	50 RB	75 RB	100 RB
Modulation Schemes	Downlink	QPSK, 16QAM, 64QAM				
	Uplink	QPSK, 16QAM, 64QAM (⇒ optional for handset)				
Multiple Access	Downlink	OFDMA (Orthogonal Frequency Division Multiple Access)				
	Uplink	SC-FDMA (Single Carrier Frequency Division Multiple Access)				
MIMO technology	Downlink	Wide choice of MIMO configuration options for transmit diversity, spatial multiplexing, and cyclic delay diversity (max. 4 antennas at base station and handset)				
	Uplink	Multi-user collaborative MIMO				
Peak Data Rate	Downlink	150 Mbps (UE category 4, 2x2 MIMO, 20 MHz) 300 Mbps (UE category 5, 4x4 MIMO, 20 MHz)				
	Uplink	75 Mbps (20 MHz)				



Multiple modulations

- QPSK (Quadrature Phase Shift Keying) = 4 phase shifts, 1 amplitude level, 2 bits/symbol
- QAM-16 = 4 phase shifts, 4 amplitude levels, 4 bits/symbol
- QAM-64 = 4 phase shifts, 16 amplitude levels, 6 bits/symbol

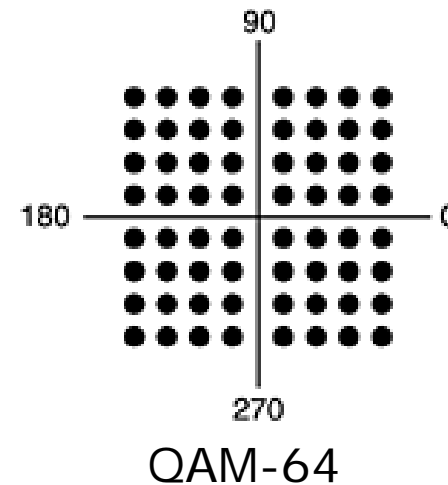
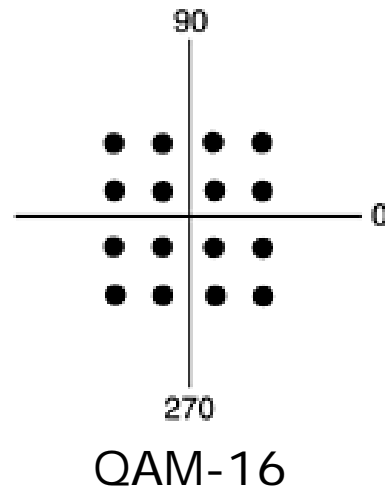
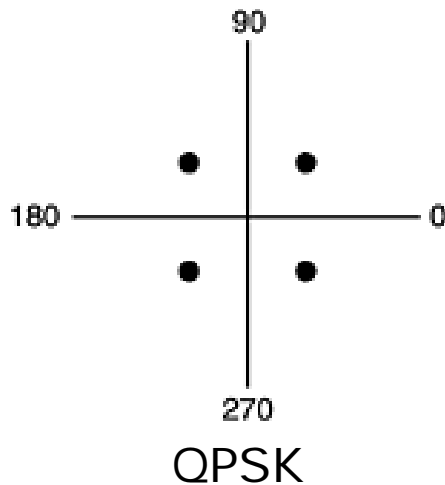

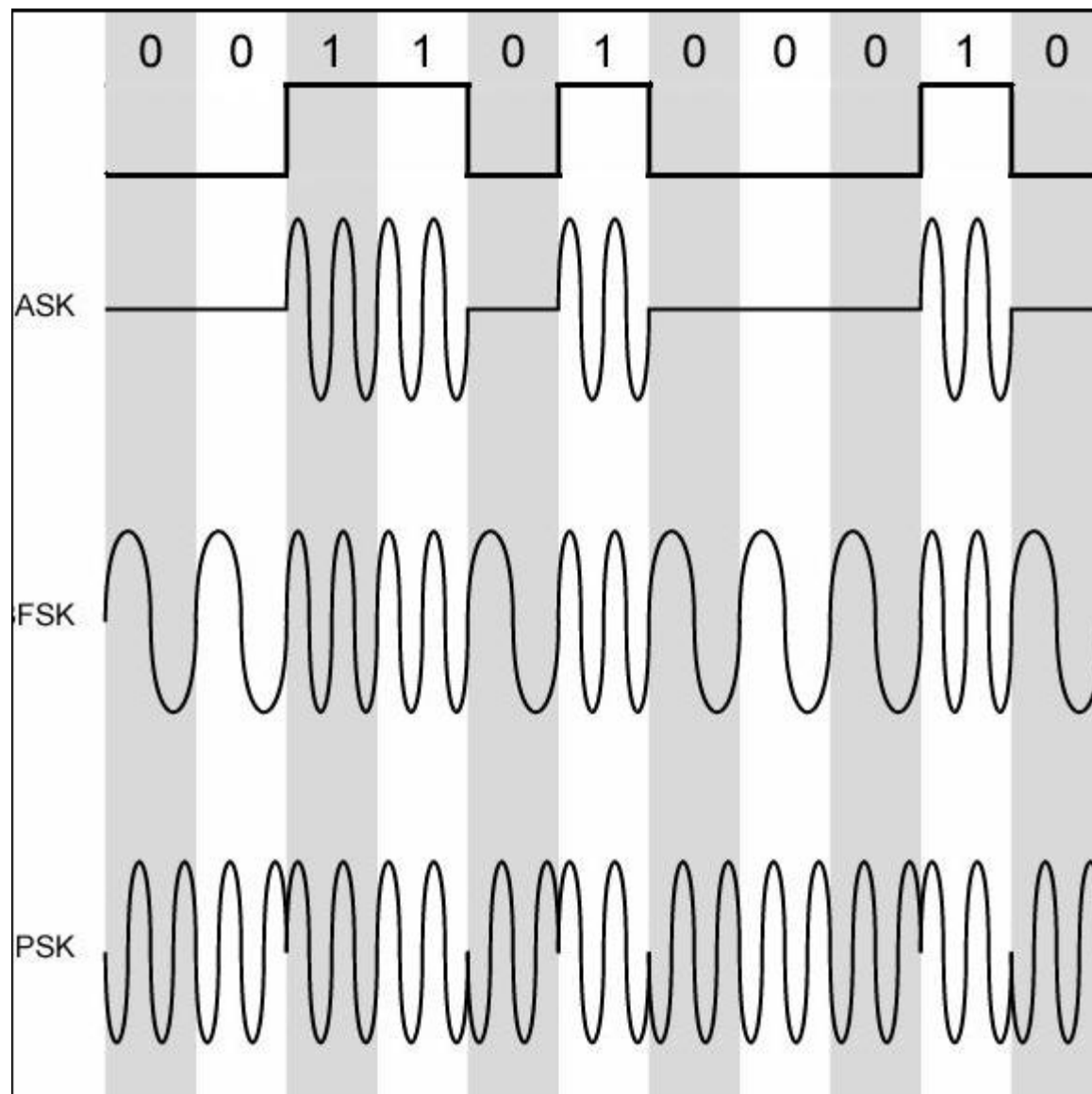

Adaptive modulation

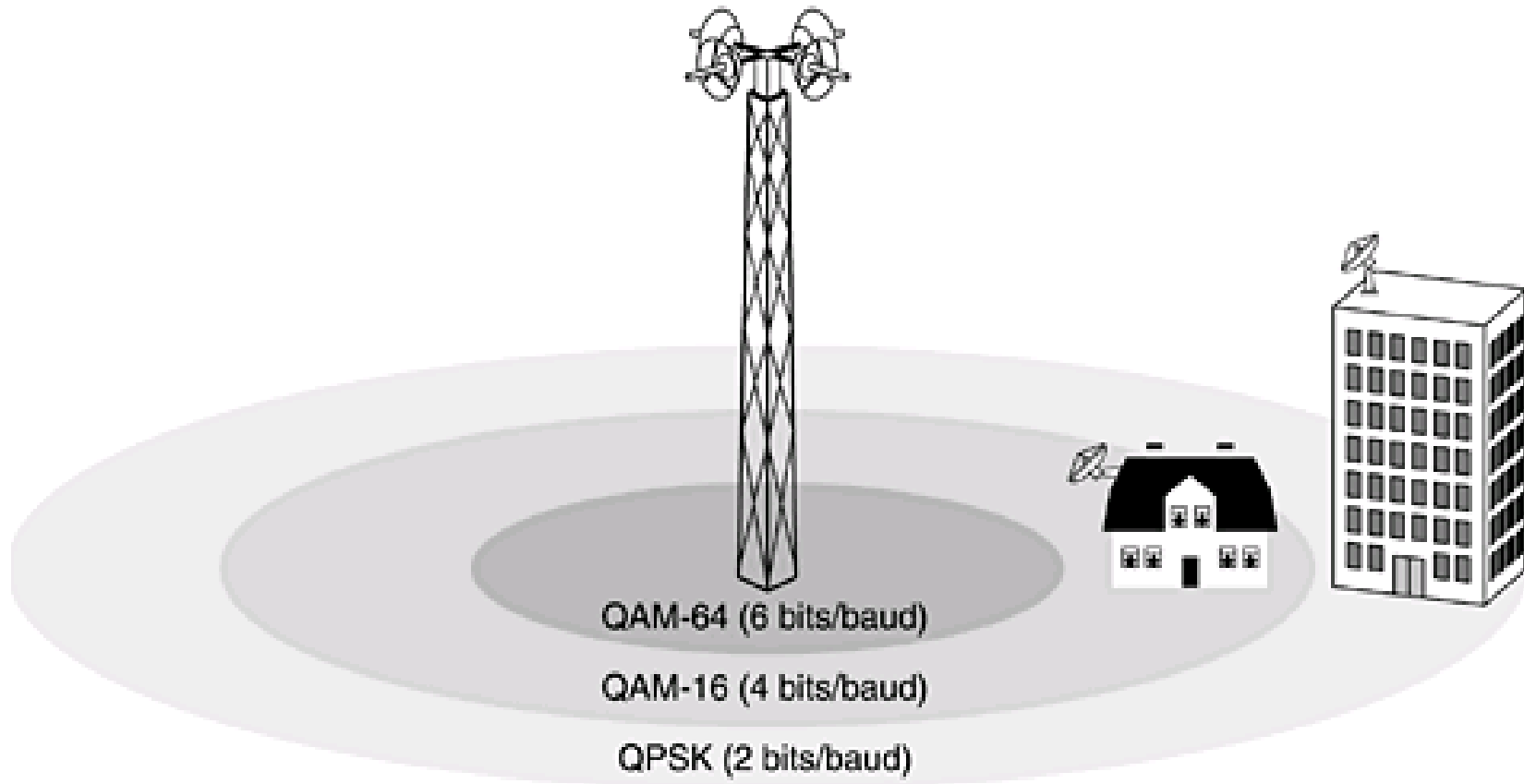



LTE frequency bands





LTE Architecture

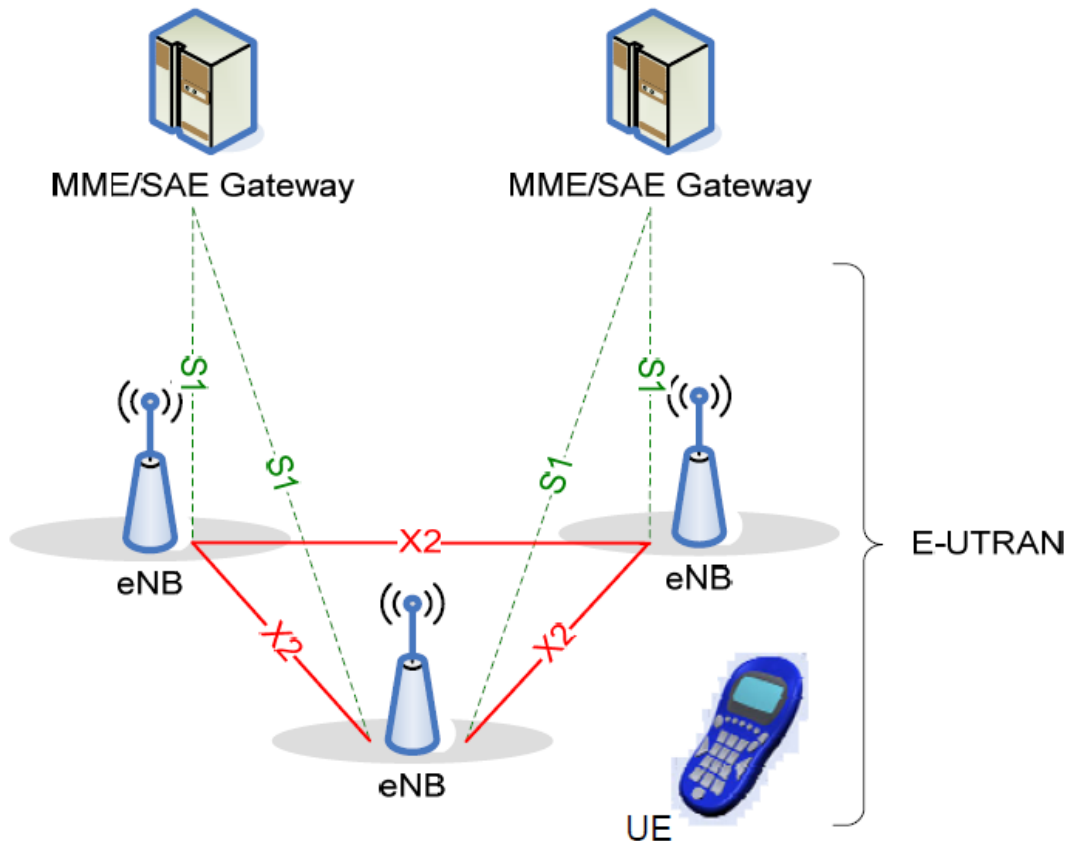

- **eNB**: Enhanced Node B, or base station
- **UE**: User Equipment
- **EPC**: Evolved Packet Core
 - **MME**: Mobility Management Entity (Control Plane)
 - **SAE**: System Architecture Evolved (User Plane)
- **E-UTRAN**: Evolved Universal Terrestrial Radio Access Network



LTE Transmission Techniques

- LTE employs Orthogonal Frequency Division Multiple Access (**OFDMA**) for downlink data transmission and Single Carrier FDMA (**SC-FDMA**) for uplink transmission

LTE-Downlink (OFDM)

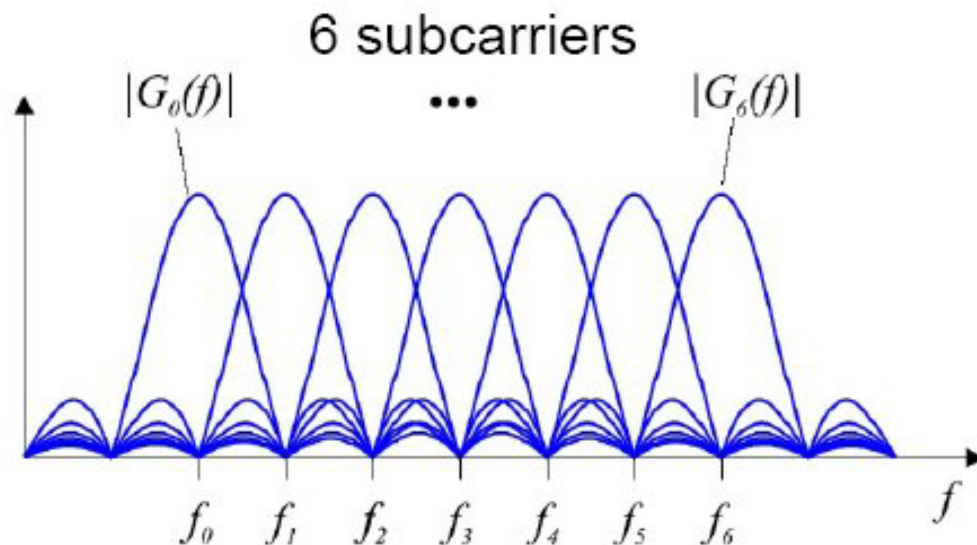
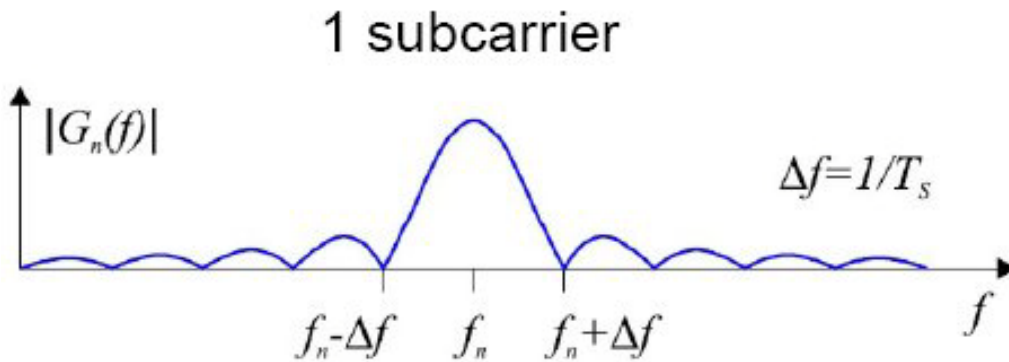

- Improved spectral efficiency
- Reduce ISI effect by multipath
- Against frequency selective fading

OFDM: Orthogonal Frequency Division Multi-Carrier

Thus OFDM simply places the next carrier exactly in the first null point of the previous one.

With this we don't need any pulse-shaping.

Between OFDM carriers using the same symbol duration T_s , no guard bands are required.

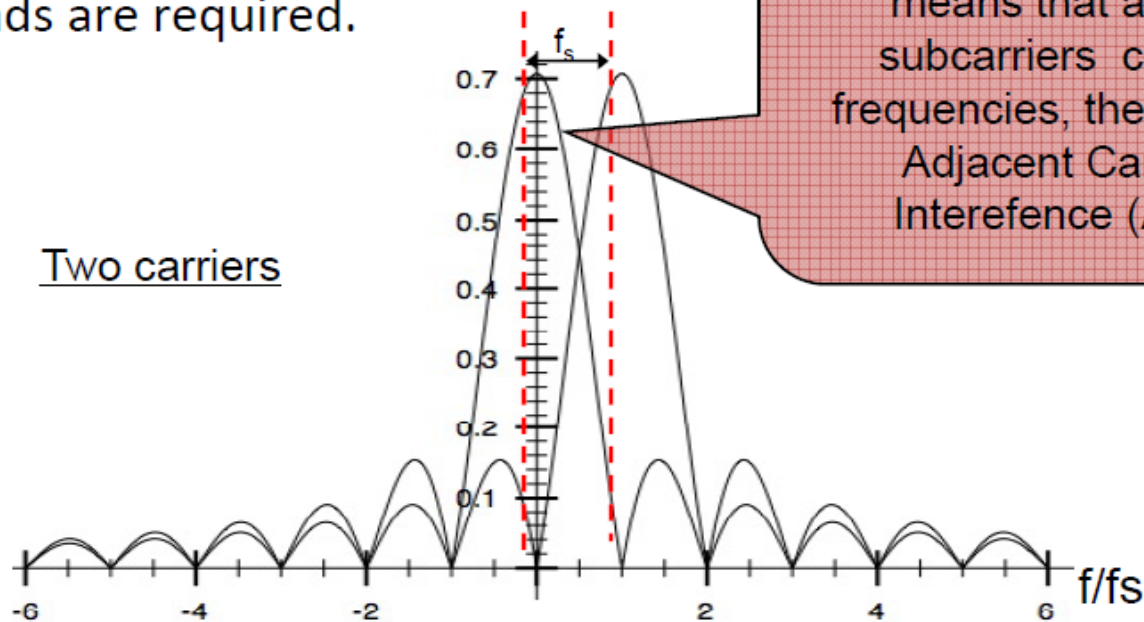

Orthogonal Subcarriers: it means that at the subcarriers center frequencies, there is no Adjacent Carrier Interference (ACI)

Spectrum Overlapping of multiple OFDM carriers

$$f_n = f_0 + n f_s = f_0 + n \frac{1}{T_s} \quad n = \dots -1, 0, 1, 2 \dots$$

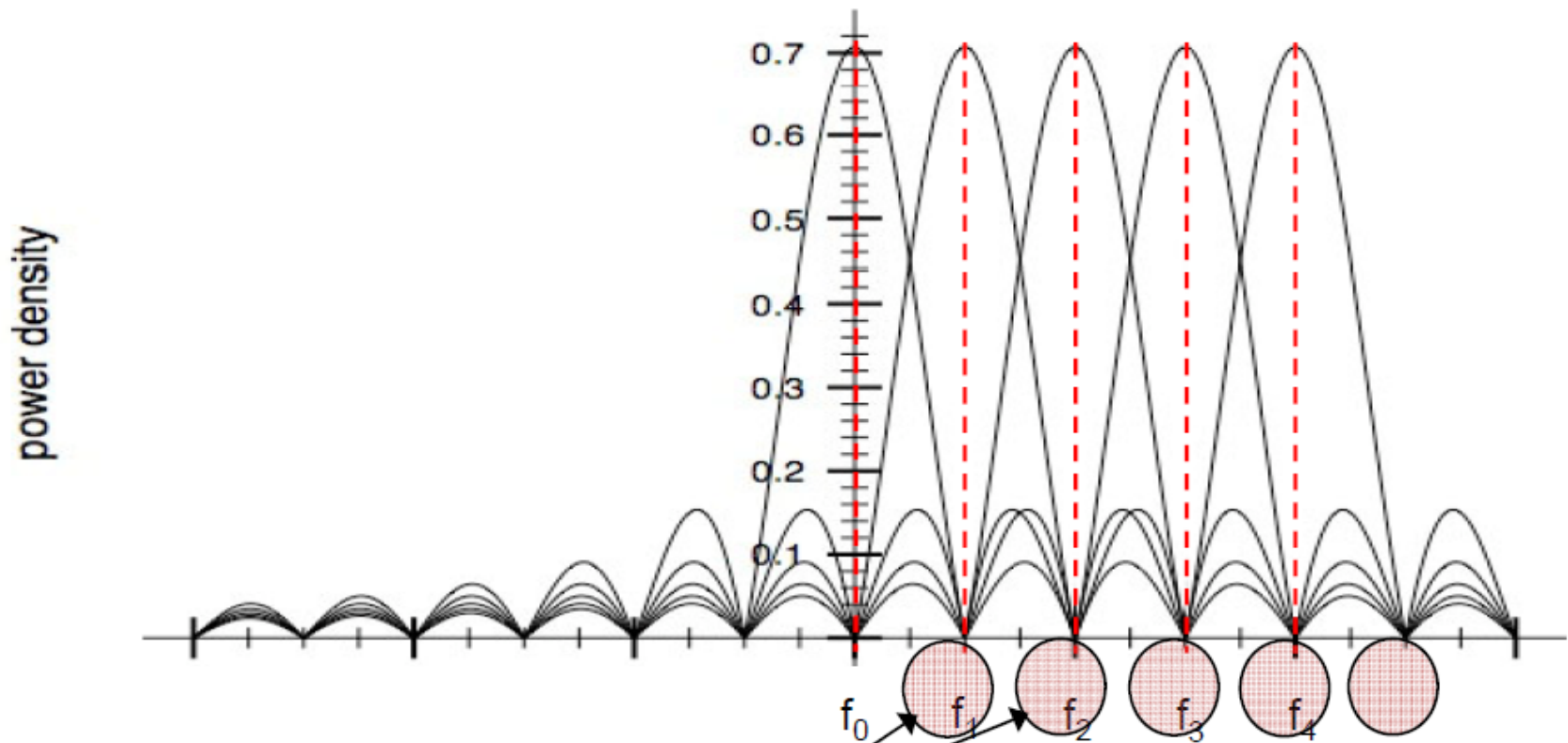

No ACI (Adjacent Carrier Interference)

OFDM pros and cons

Pros

- Spectral **efficiency**
- **Robust** against narrow-band co-channel **interference**
- Higher **throughput** in the same frequency band (more subcarriers)

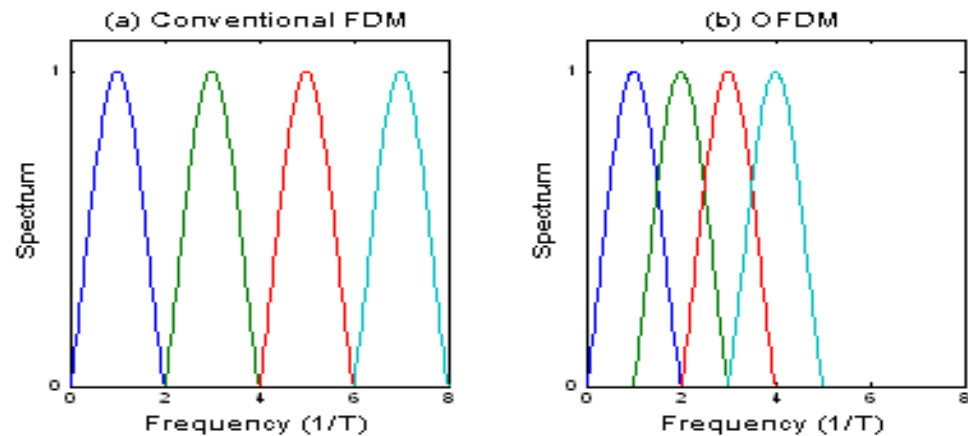

Cons

- It is more sensitive to **carrier frequency offsets**
- More **energy requirements** due to high peak-to-average power ratio (PAPR)



SC/OFDM/OFDMA

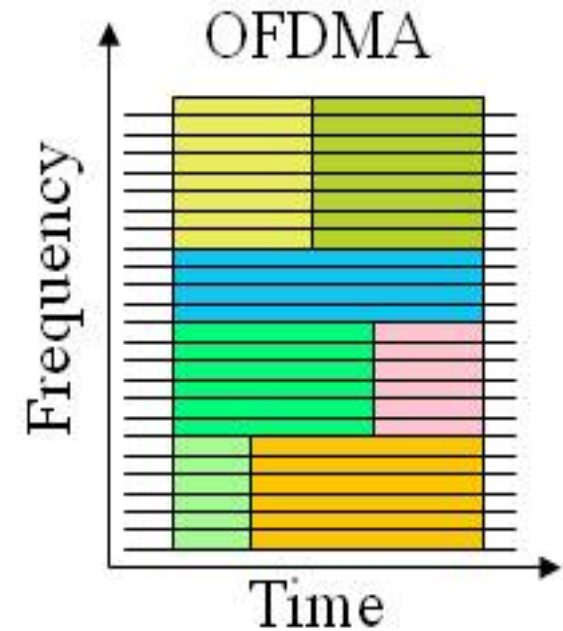
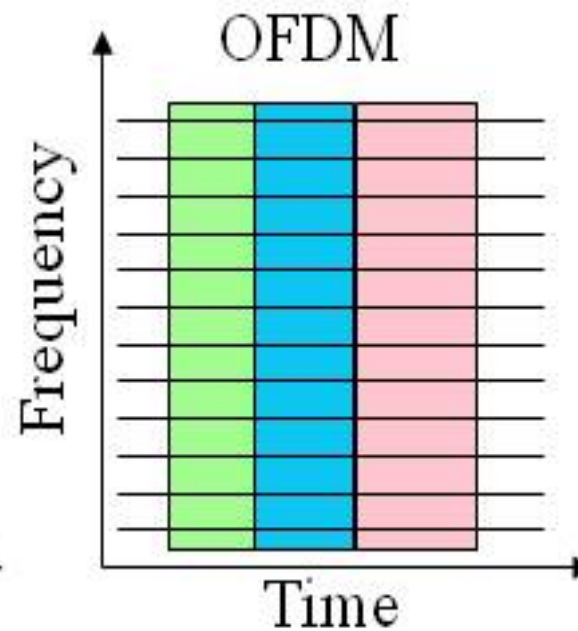
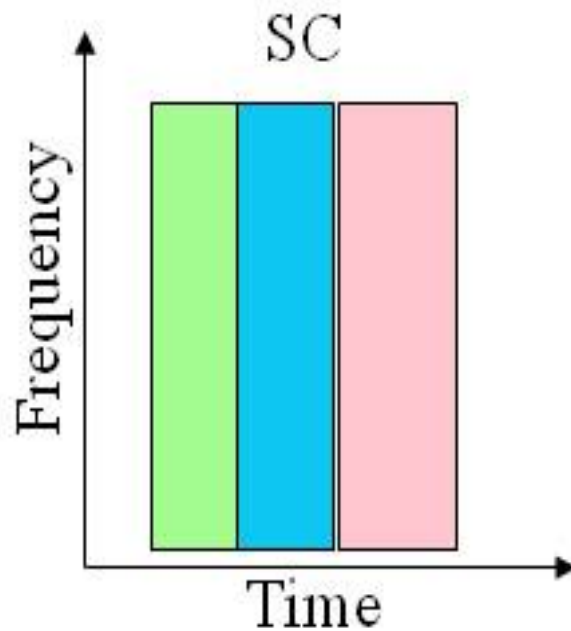



OFDMA allocation

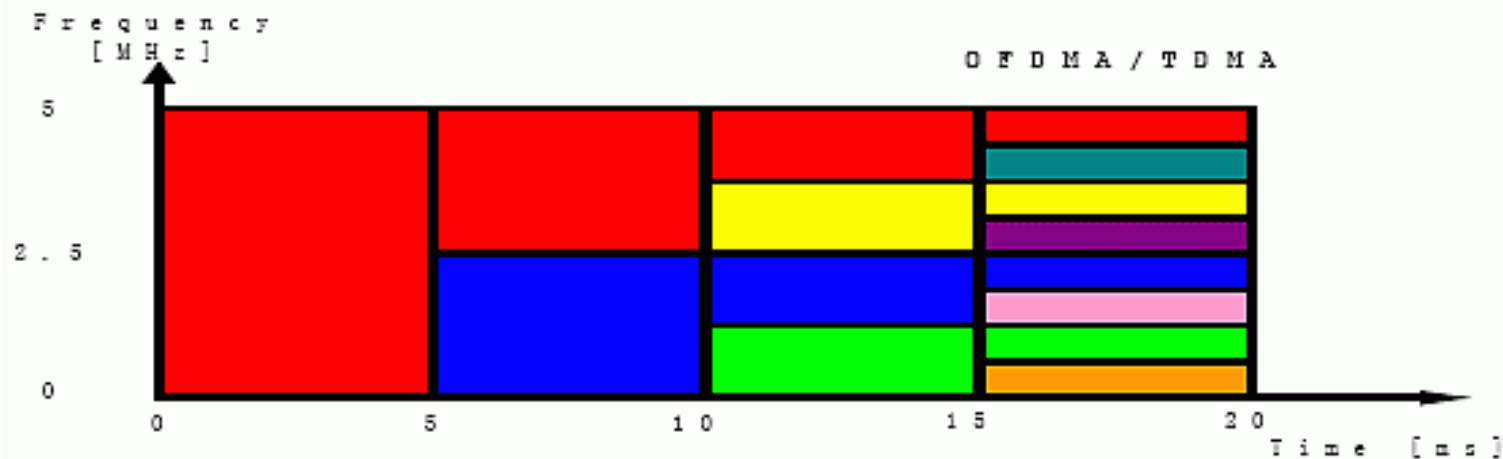
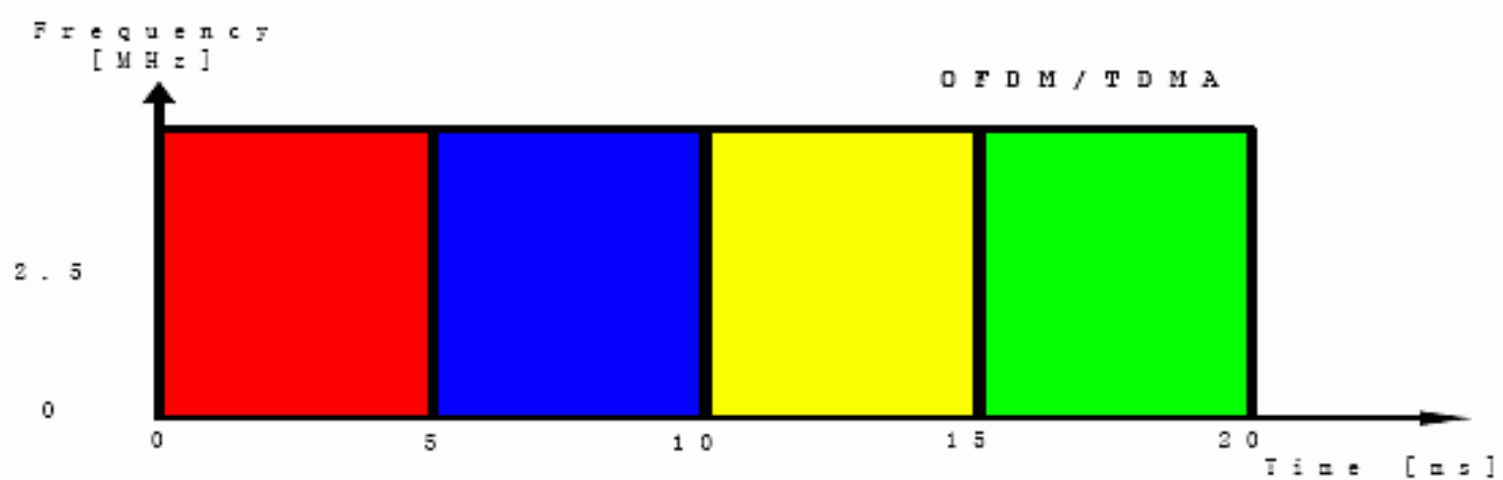

LTE Uplink (SC-FDMA)

- SC-FDMA is a new single carrier multiple access technique which has similar structure and performance to OFDMA
- More complex, but consumes less power

OFDMA transmits the four QPSK data symbols in parallel, one per subcarrier

SC-FDMA transmits the four QPSK data symbols in series at four times the rate, with each data symbol occupying $N \times 15$ kHz bandwidth.

Visually, the OFDMA signal is clearly multi-carrier and the SC-FDMA signal looks more like single-carrier, which explains the “SC” in its name.

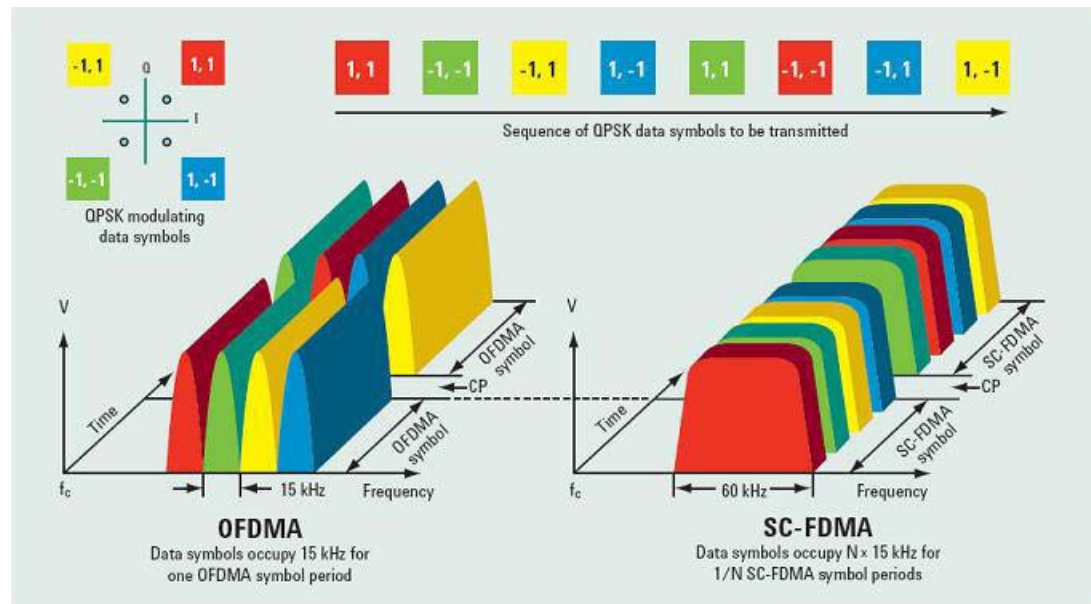



LTE spectrum flexibility

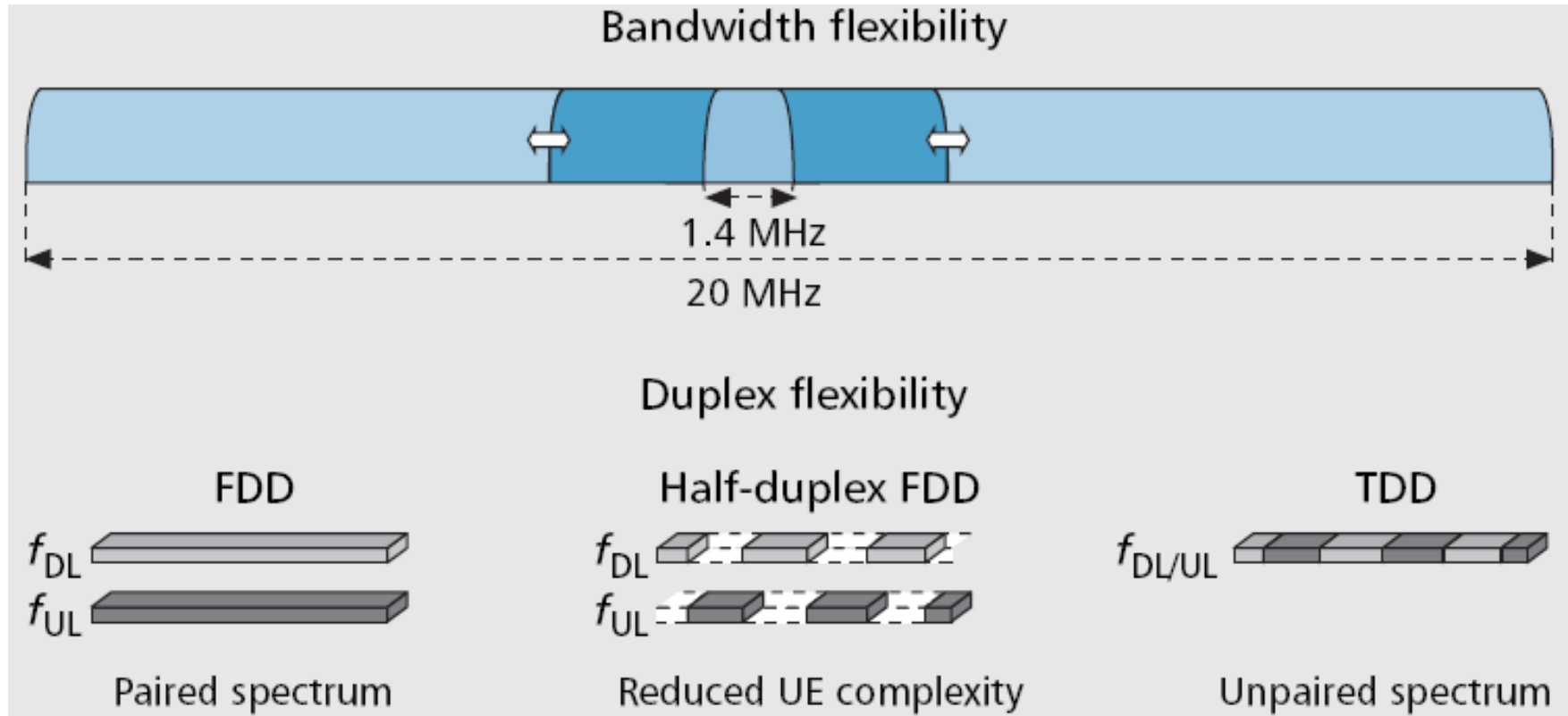



Generic Frame Structure

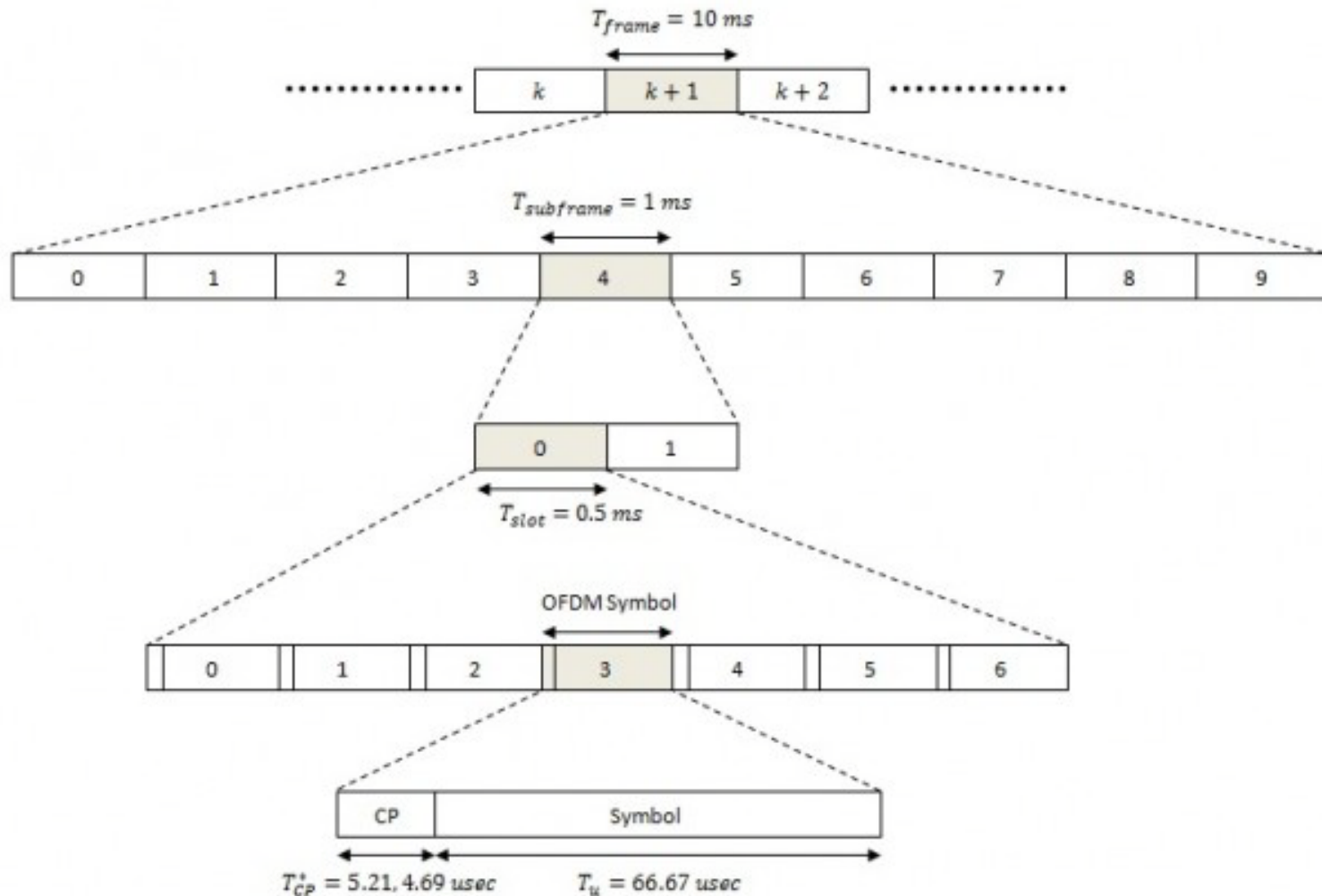



Both TDD and FDD support

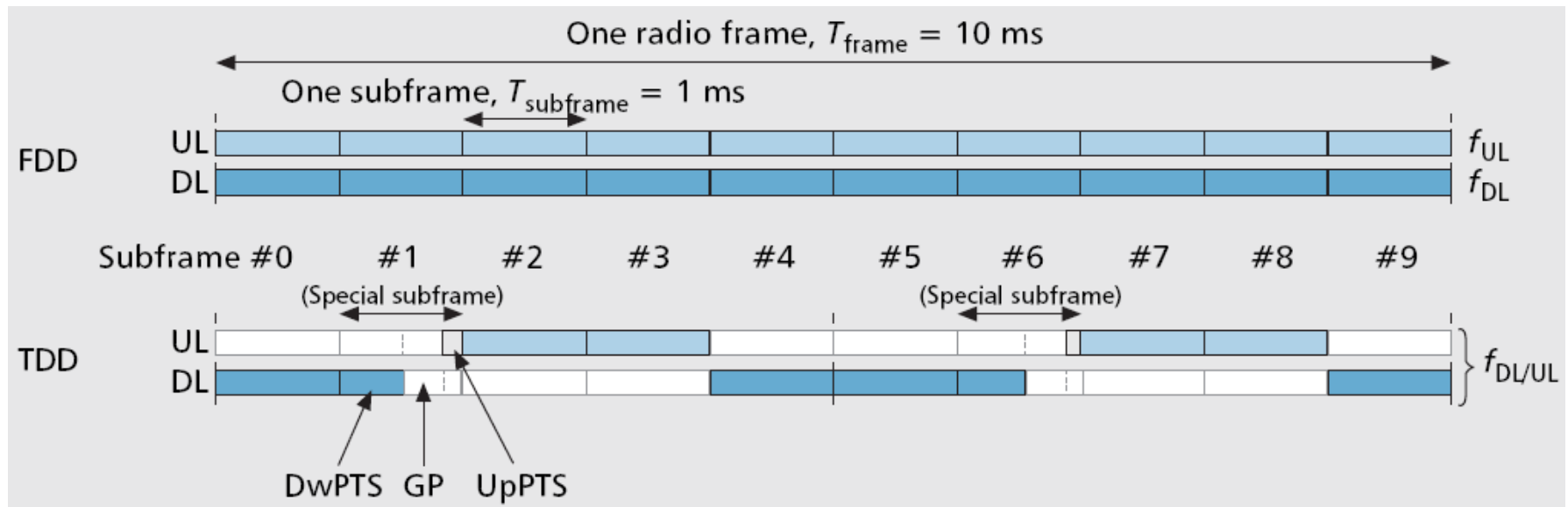

Resource Grid

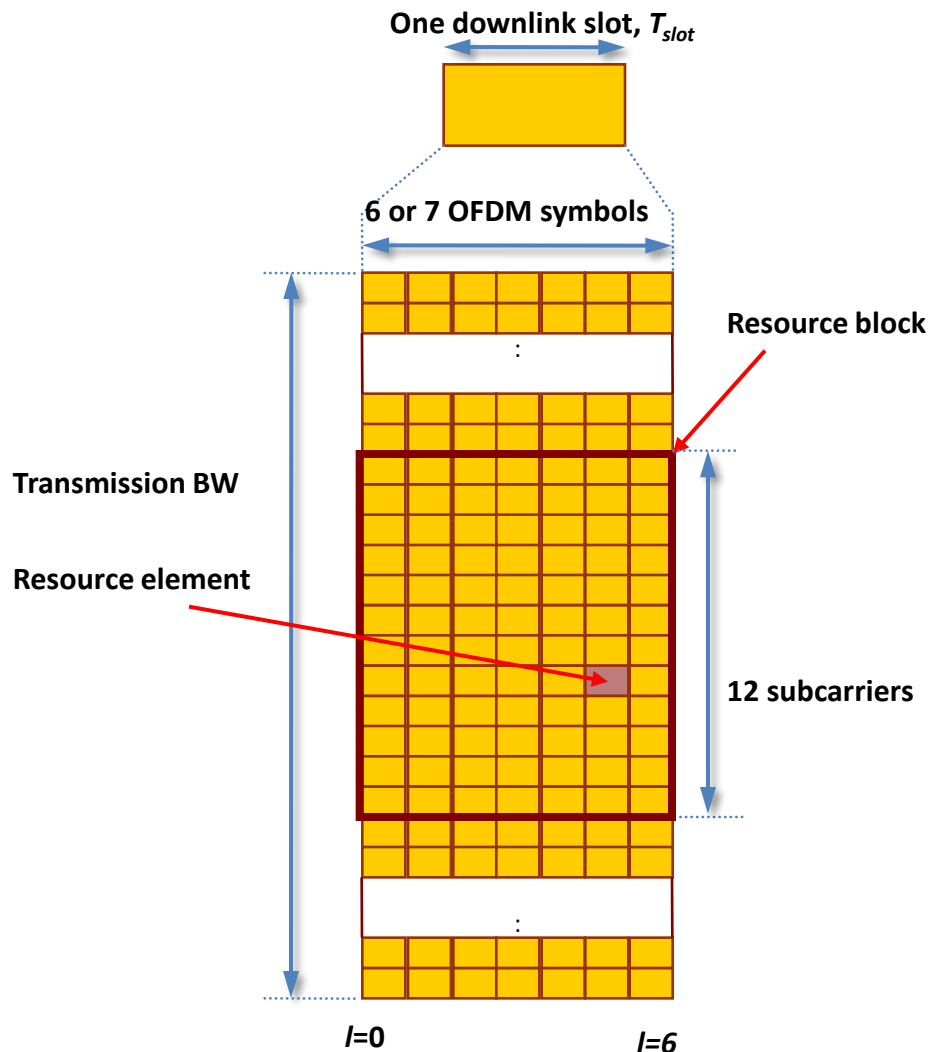

- 6 or 7 OFDM symbols in 1 slot
- Subcarrier spacing = 15 kHz
- Block of 12 SCs in 1 slot = 1 RB
 - $0.5\text{ ms} \times 180\text{ kHz}$
 - Smallest unit of allocation



Resource grid 2D

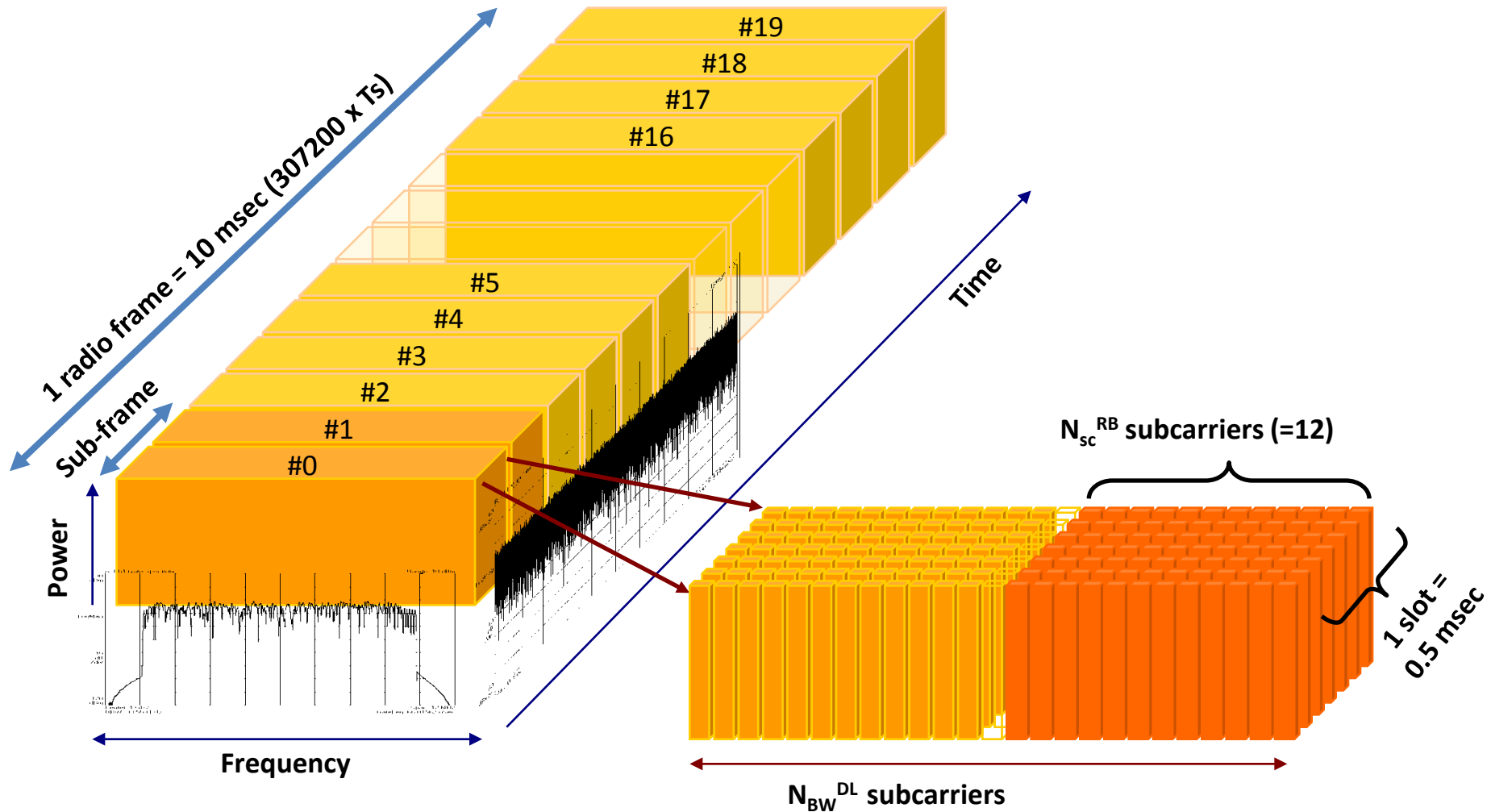

- Allocation of physical resource blocks (PRBs) is handled by a scheduling function at the 3GPP base station (eNodeB)

One resource element

QPSK, 2bits
16QAM, 4bits
64QAM, 6bits

$\Delta f = 15\text{kHz}$

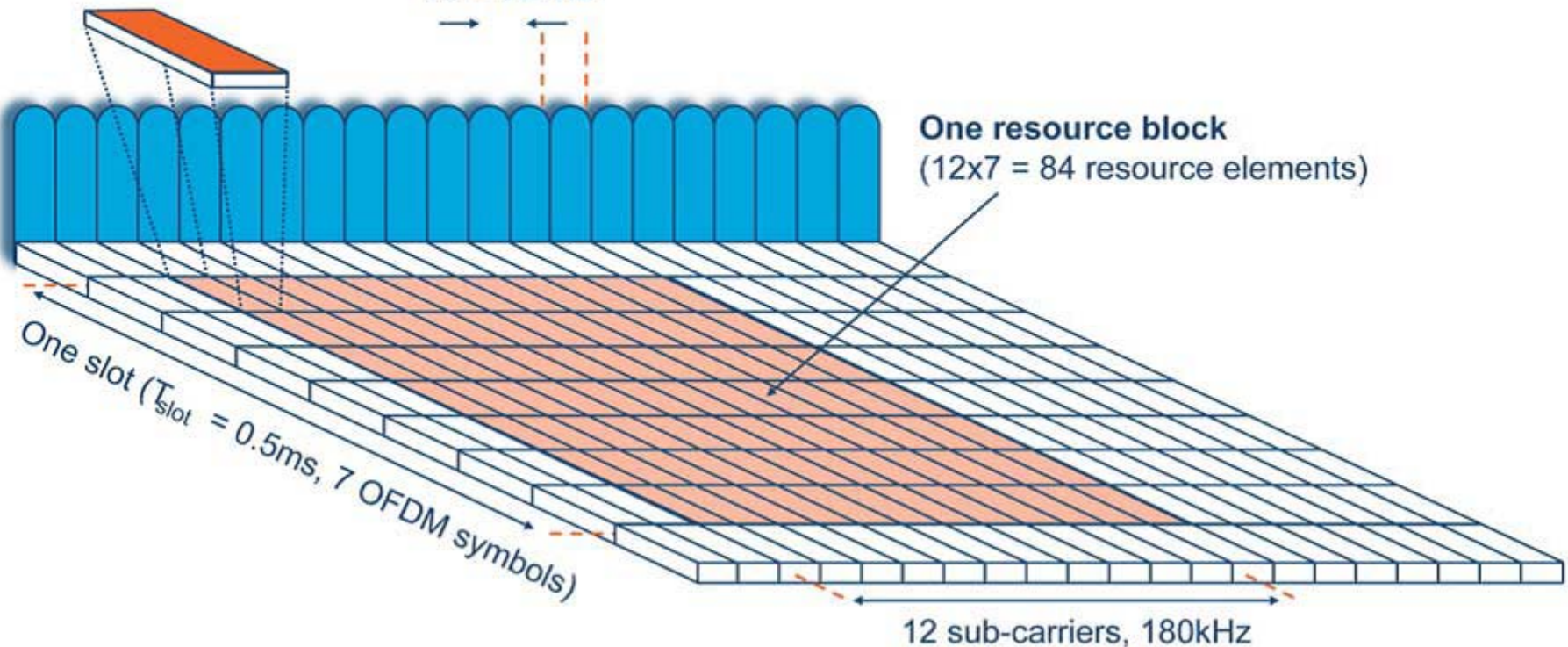

FTE Frame Structure

LTE FDD Frame
1.4 MHz, Normal CP

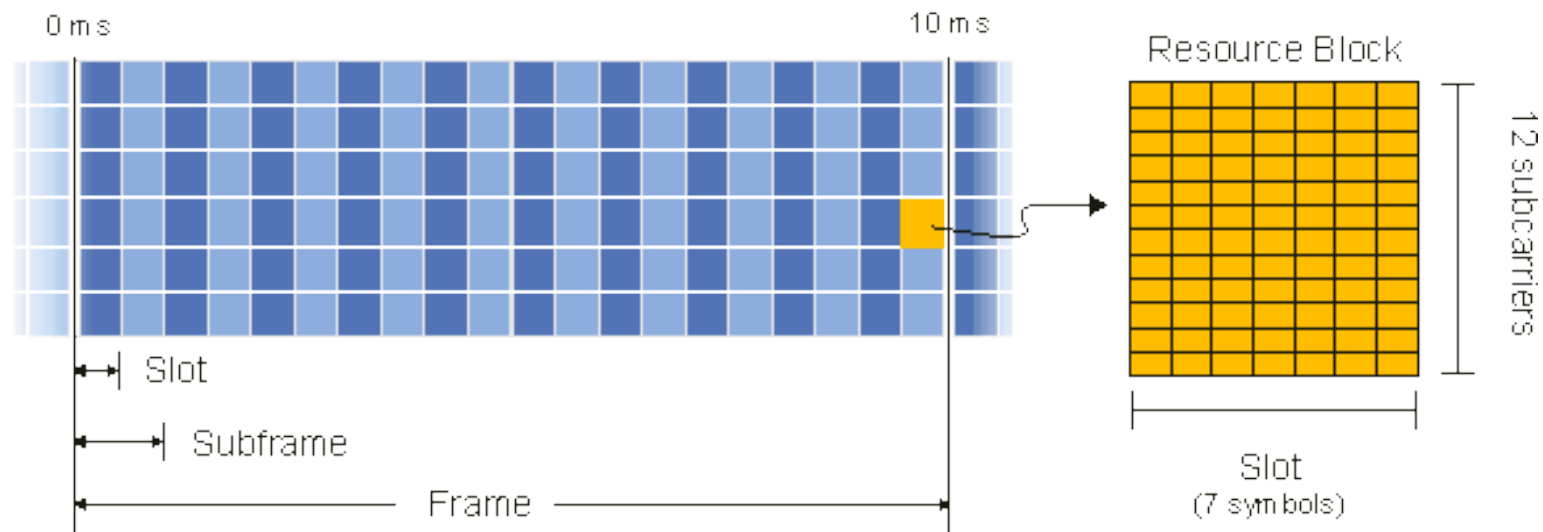



Control information through Logical Channels

Paging Control Channel (PCCH)

- A downlink channel that transfers paging information and system information change notifications.
- This channel is used for paging when the network does not know the location cell of the UE.

Broadcast Control Channel (BCCH)

- A downlink channel for broadcasting system control information.

Common Control Channel (CCCH)

- Channel for transmitting control information between UEs and network.
- This channel is used for UEs having no RRC connection with the network.

LTE-A main features

Support of Wider Bandwidth(Carrier Aggregation)

- Use of multiple component carriers(CC) to **extend bandwidth up to 100 MHz**
- Common physical layer parameters between component carrier and LTE Rel-8 carrier
- ➔ **Improvement of peak data rate**, **backward compatibility with LTE Rel-8**

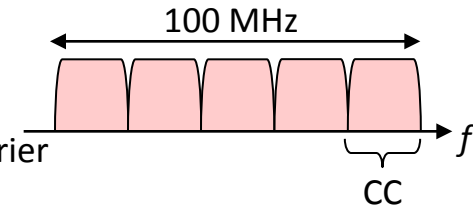

Advanced MIMO techniques

- Extension to up to **8-layer transmission in downlink**
- Introduction of single-user MIMO up to **4-layer transmission in uplink**
- Enhancements of multi-user MIMO
- ➔ **Improvement of peak data rate and capacity**

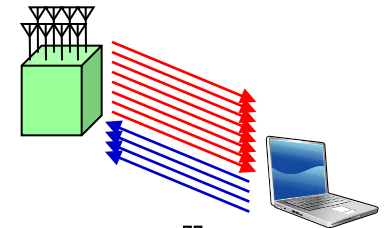

Heterogeneous network and eICIC (enhanced Inter-Cell Interference Coordination)

- **Interference coordination** for overlaid deployment of cells with different Tx power
- ➔ **Improvement of cell-edge throughput and coverage**

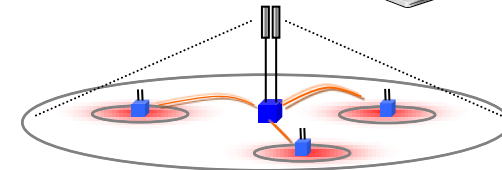

Relay

- Supports radio backhaul and **creates a separate cell** and appear as Rel. 8 LTE eNB to Rel. 8 LTE UEs
- ➔ **Improvement of coverage and flexibility of service area extension**

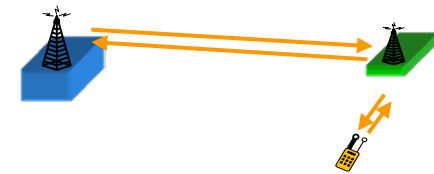

Coordinated Multi-Point transmission and reception (CoMP)

- Support of **multi-cell transmission and reception**
- ➔ **Improvement of cell-edge throughput and coverage**

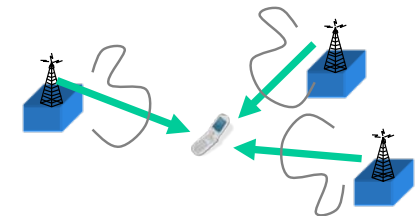



LTE / LTE-A comparison

Technology	LTE	LTE--A
Peak data rate Down Link (DL)	150 Mbps	1 Gbps
Peak data rate Up Link (UL)	75 Mbps	500 Mbps
Transmission bandwidth DL	20MHz	100 MHz
Transmission bandwidth UL	20MHz	40 MHz (requirements as defined by ITU)
Mobility	Optimized for low speeds(<15 km/hr) High Performance At speeds up to 120 km/hr Maintain Links at speeds up to 350 km/hr	Same as that in LTE
Coverage	Full performance up to 5 km	a) Same as LTE requirement b) Should be optimized or deployment in local areas/micro cell environments.
Scalable Band Widths	1.3,3, 5, 10, and 20 MHz	Up to 20–100 MHz
Capacity	200 active users per cell in 5 MHz.	3 times higher than that in LTE



Backward compatibility

LTE-Advanced backward compatibility with LTE Rel-8

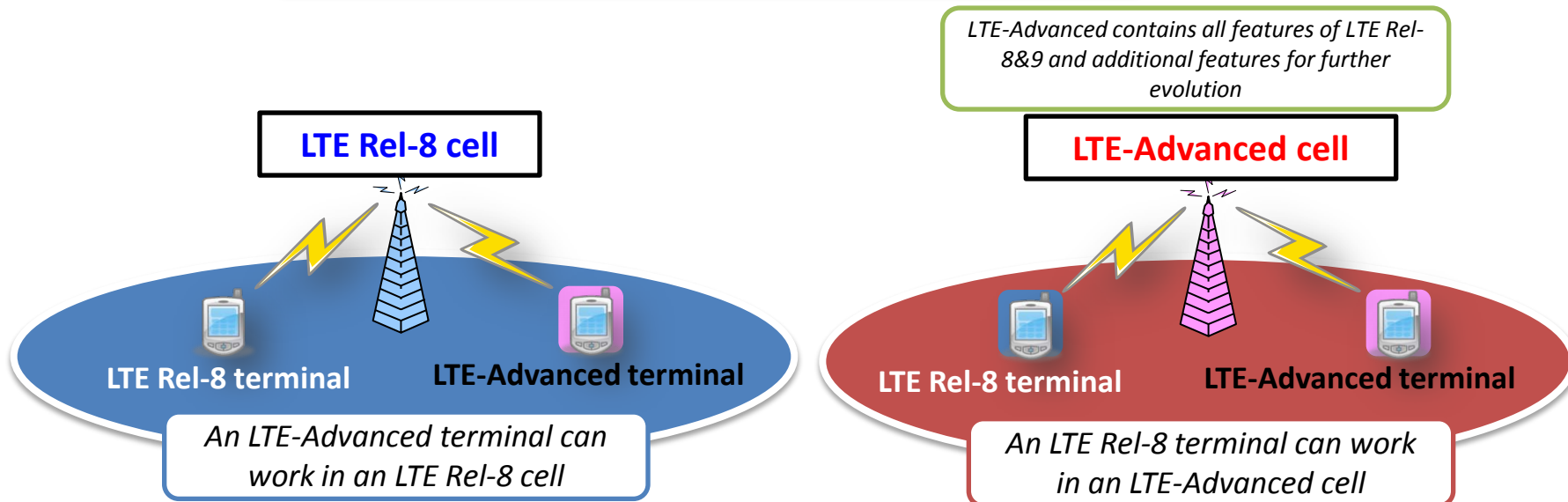



Carrier aggregation

- Extends the maximum transmission bandwidth, **up to 100MHz**, by aggregating up to five LTE carriers – also known as component carriers (CCs)
- Lack of sufficient contiguous spectrum forces use of carrier aggregation to meet peak data rate targets:
 - 1 Gbps in the downlink and 500 Mbps in the uplink
- Motivation:
 - Achieve **wide bandwidth transmissions**
 - Facilitate efficient use of **fragmented spectrum**
 - Efficient **interference management** for control channels in heterogeneous networks

Carrier aggregation

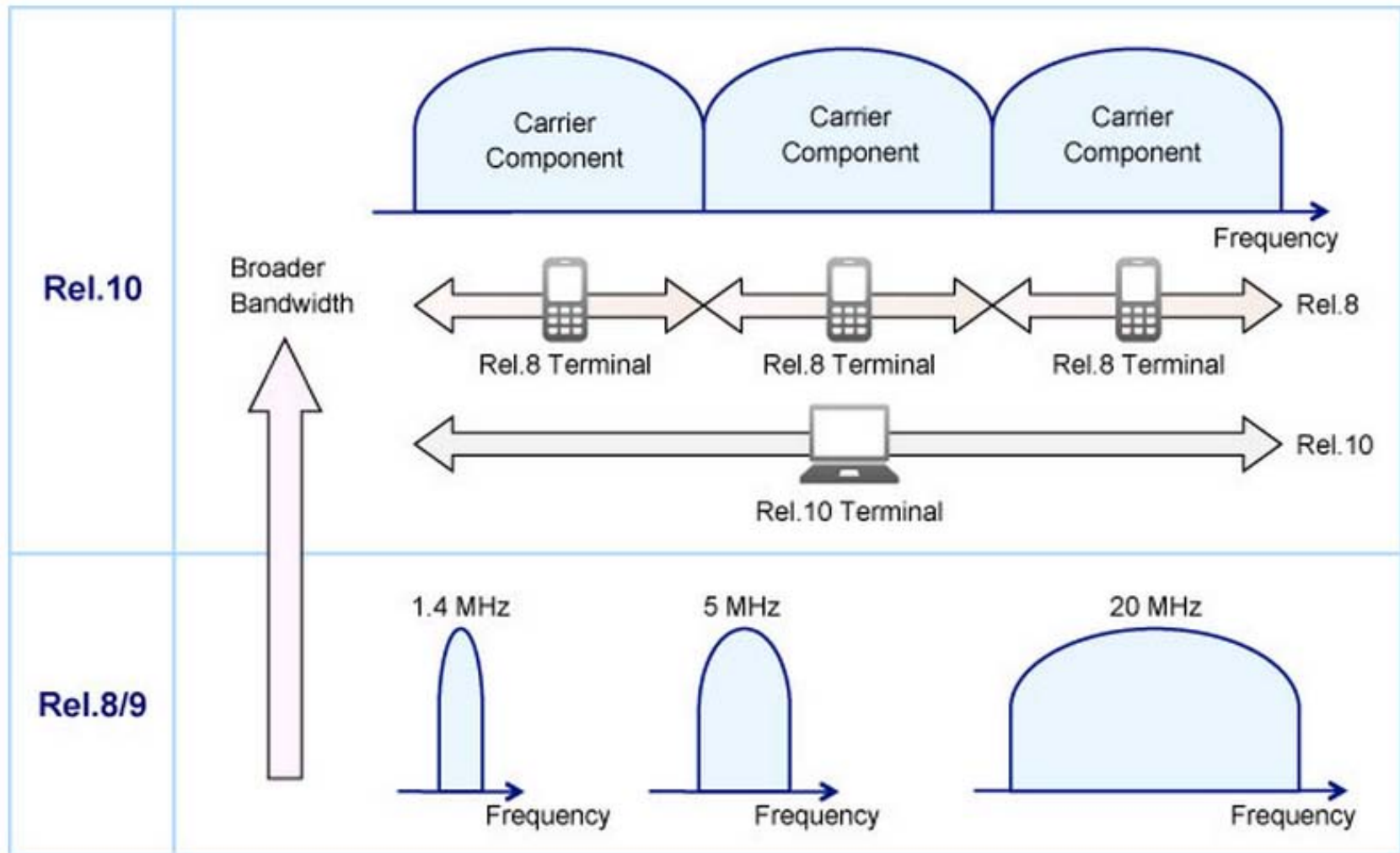



Carrier aggregation modes

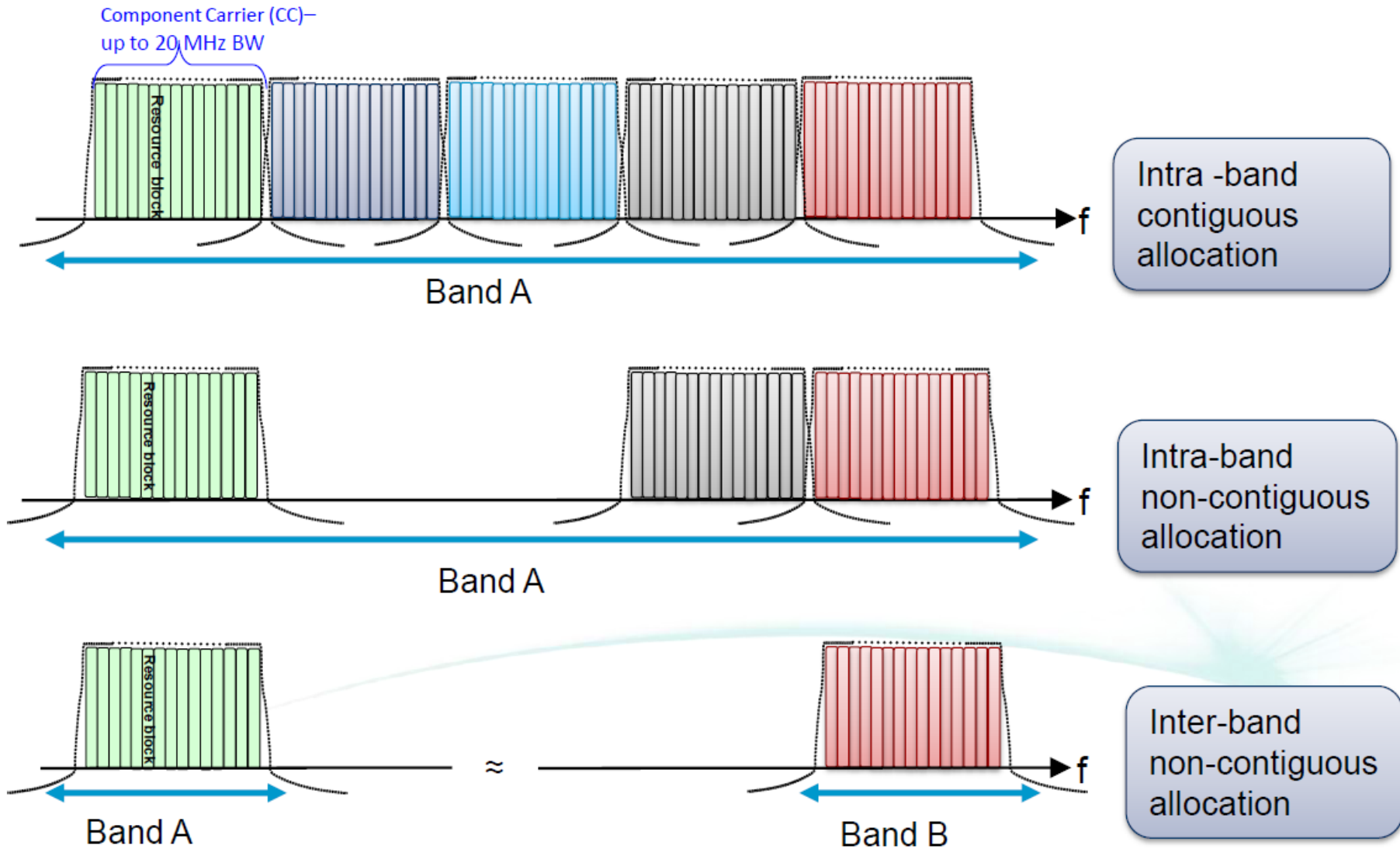



MIMO capabilities

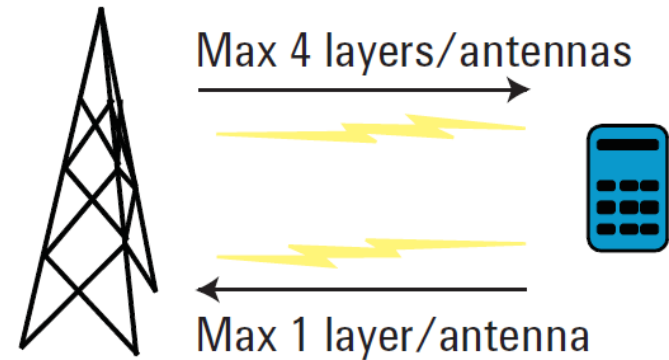
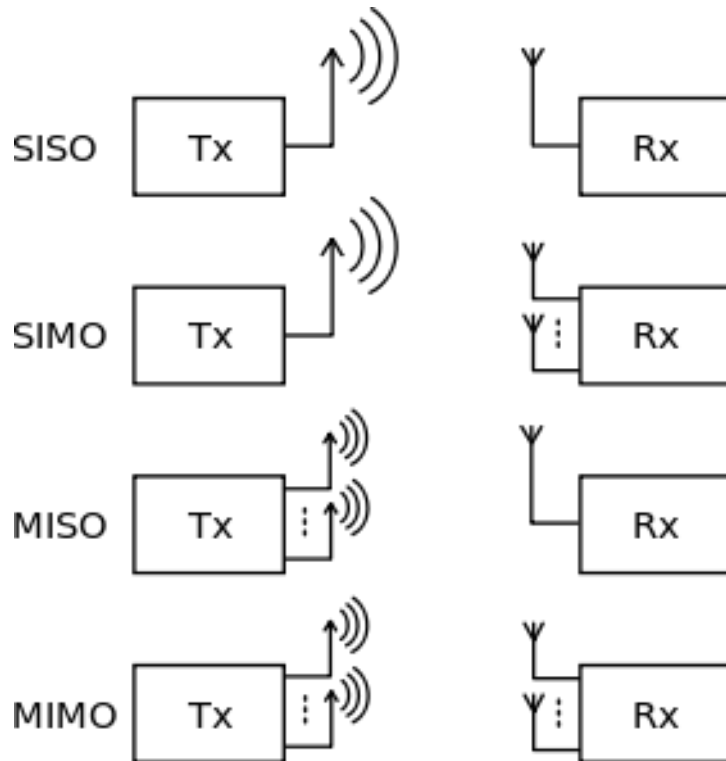

LTE

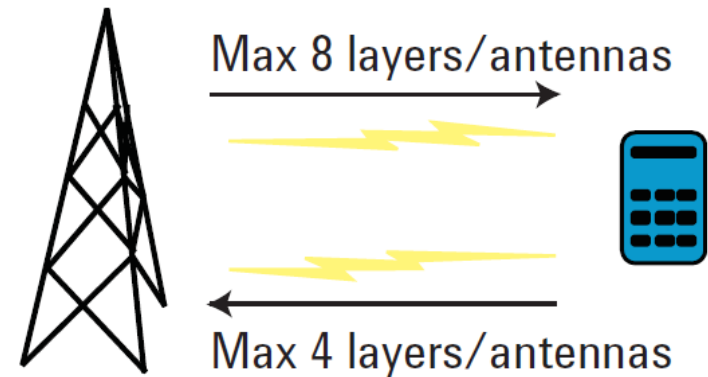

LTE-A

3 different MIMO capabilities

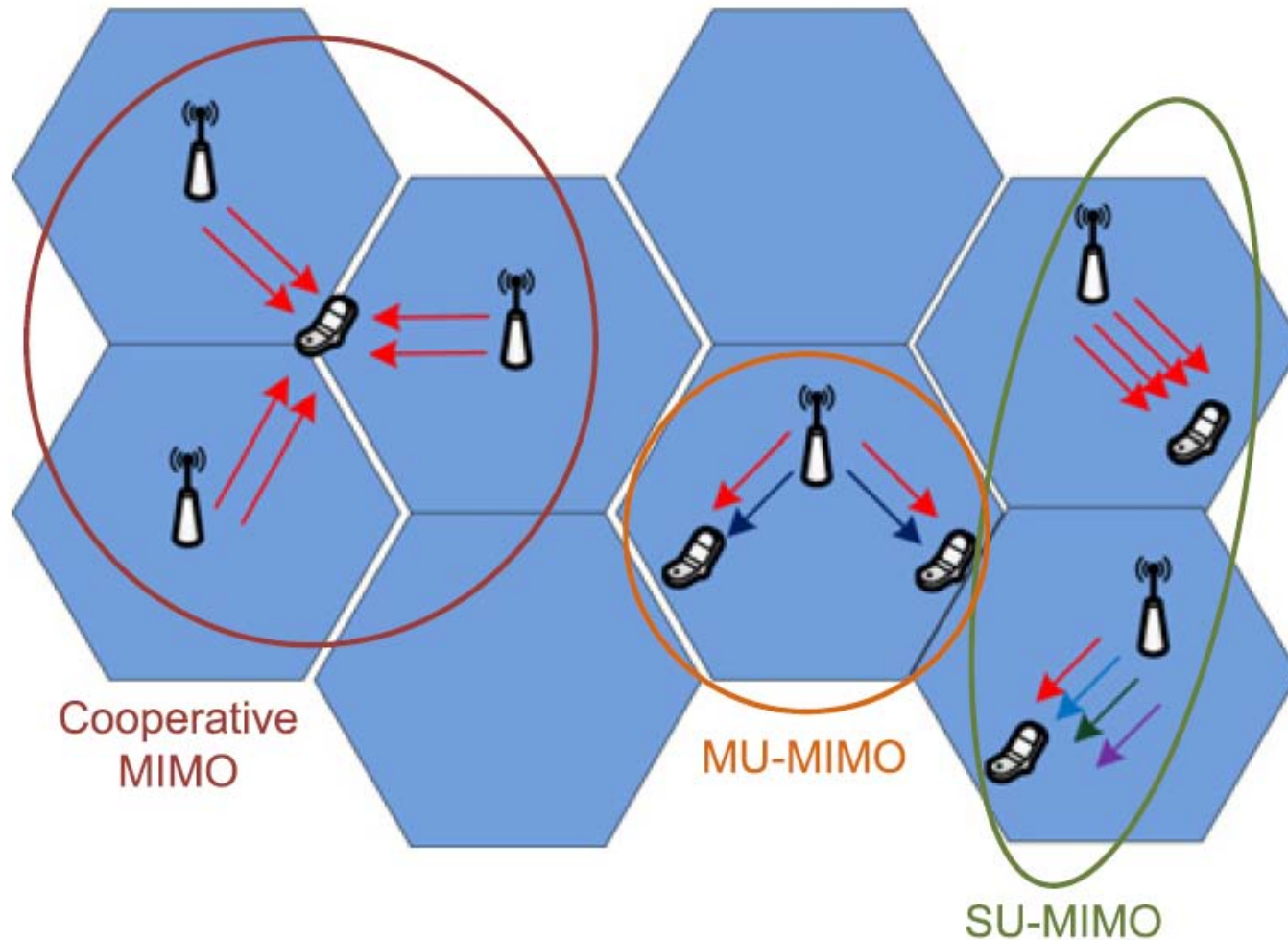

SU-MIMO vs MU-MIMO

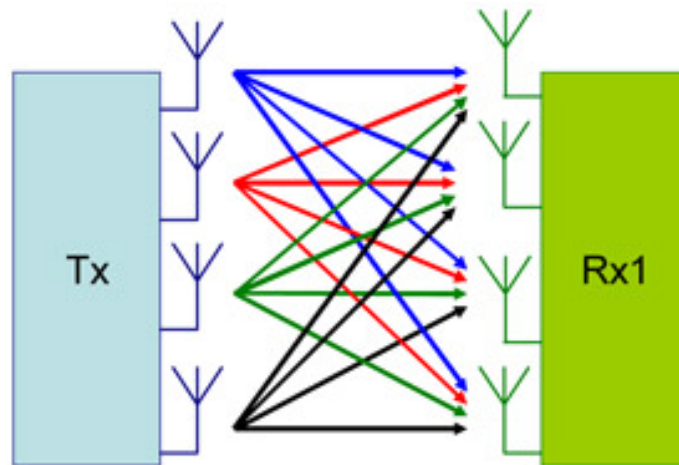

(a) Single User MIMO, 4 streams

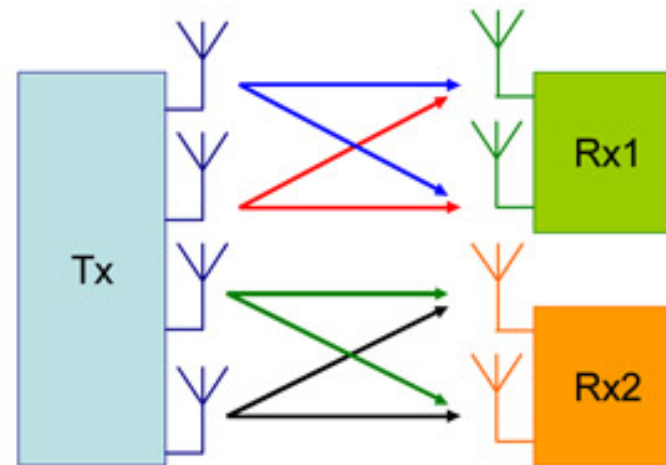

(b) Multi User MIMO, 2 users, 2 streams each

Heterogeneous networks in LTE-A

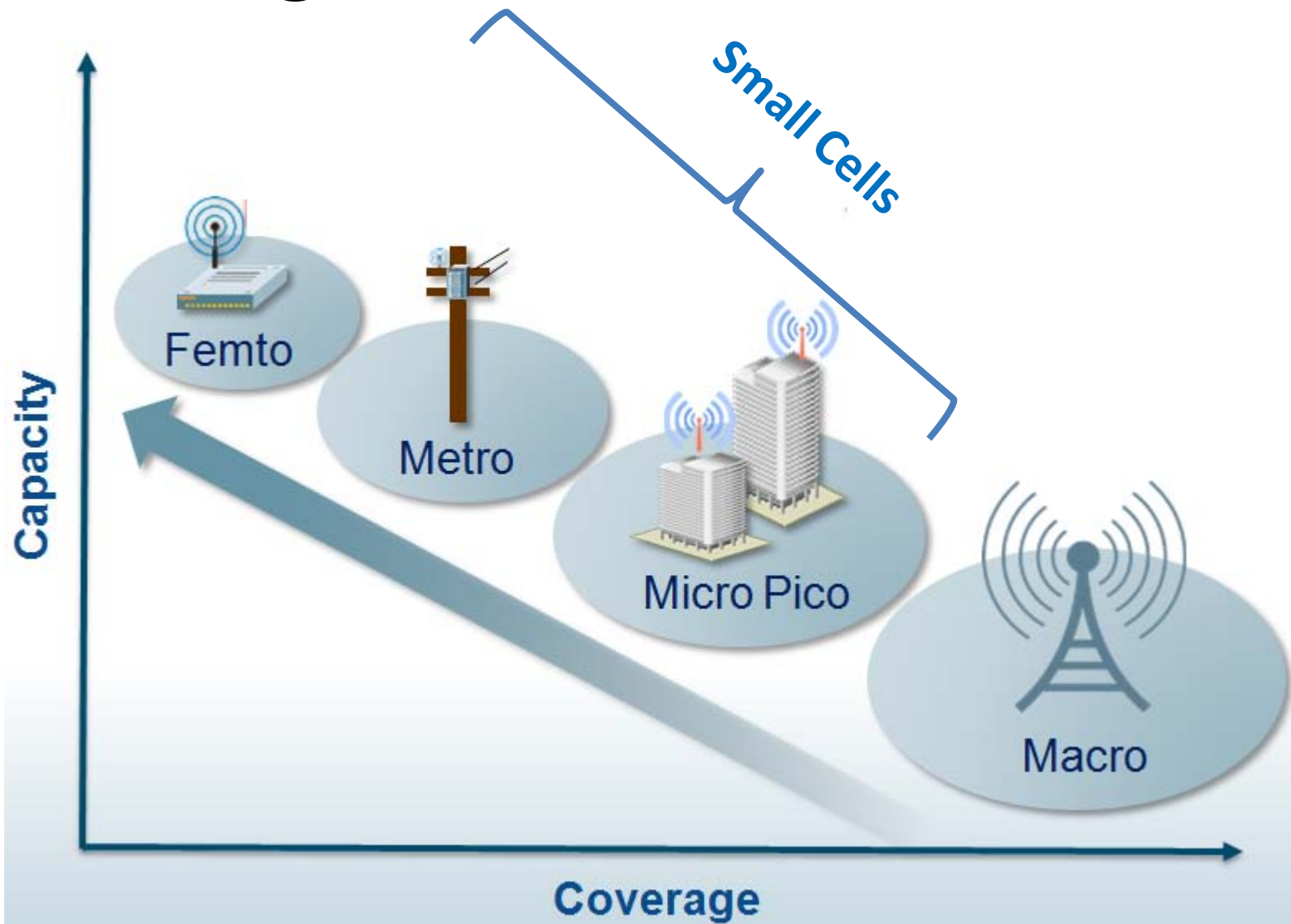

Heterogeneous networks in LTE-A

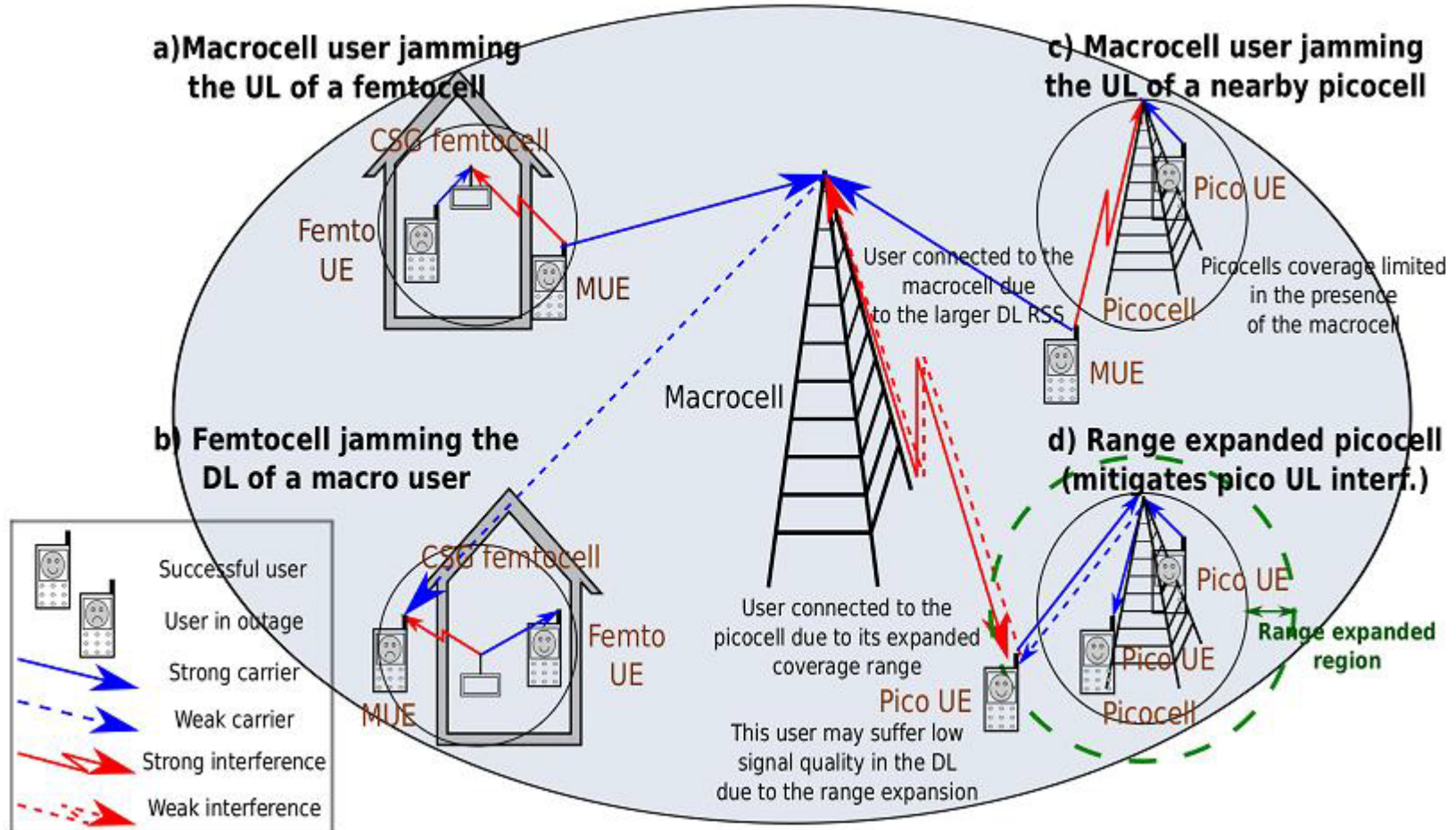



enhanced Inter-Cell Interference Coordination (eICIC)

- Coordination between eNBs at **different tiers** (e.g. femto-macro) to mitigate interference
- Three categories
 - Time-domain: **Almost Blank Subframes** (ABSFs) at macrocells, where no control or data signals are transmitted.
 - Frequency-domain: Select **different frequency** channels for victim users in macro and femto
 - Power-domain: **Reduce power in femtocell** to mitigate interference to macrocell

Almost Blank Subframes

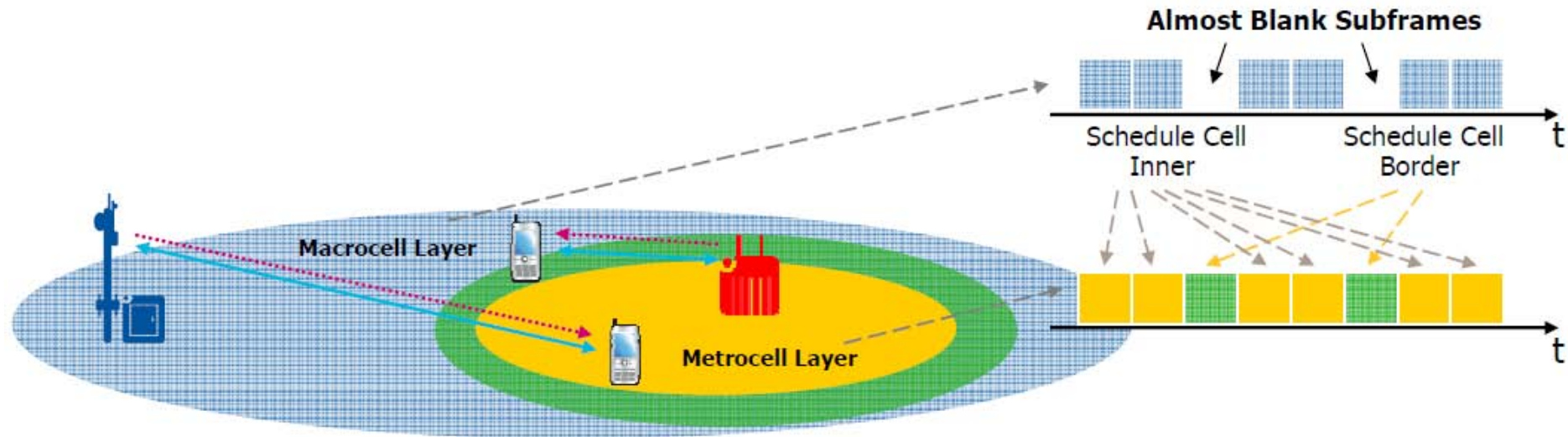

- Increased coverage
- Higher spectral efficiency
- Significant improvement in capacity and cell edge performance



Relaying in LTE-A

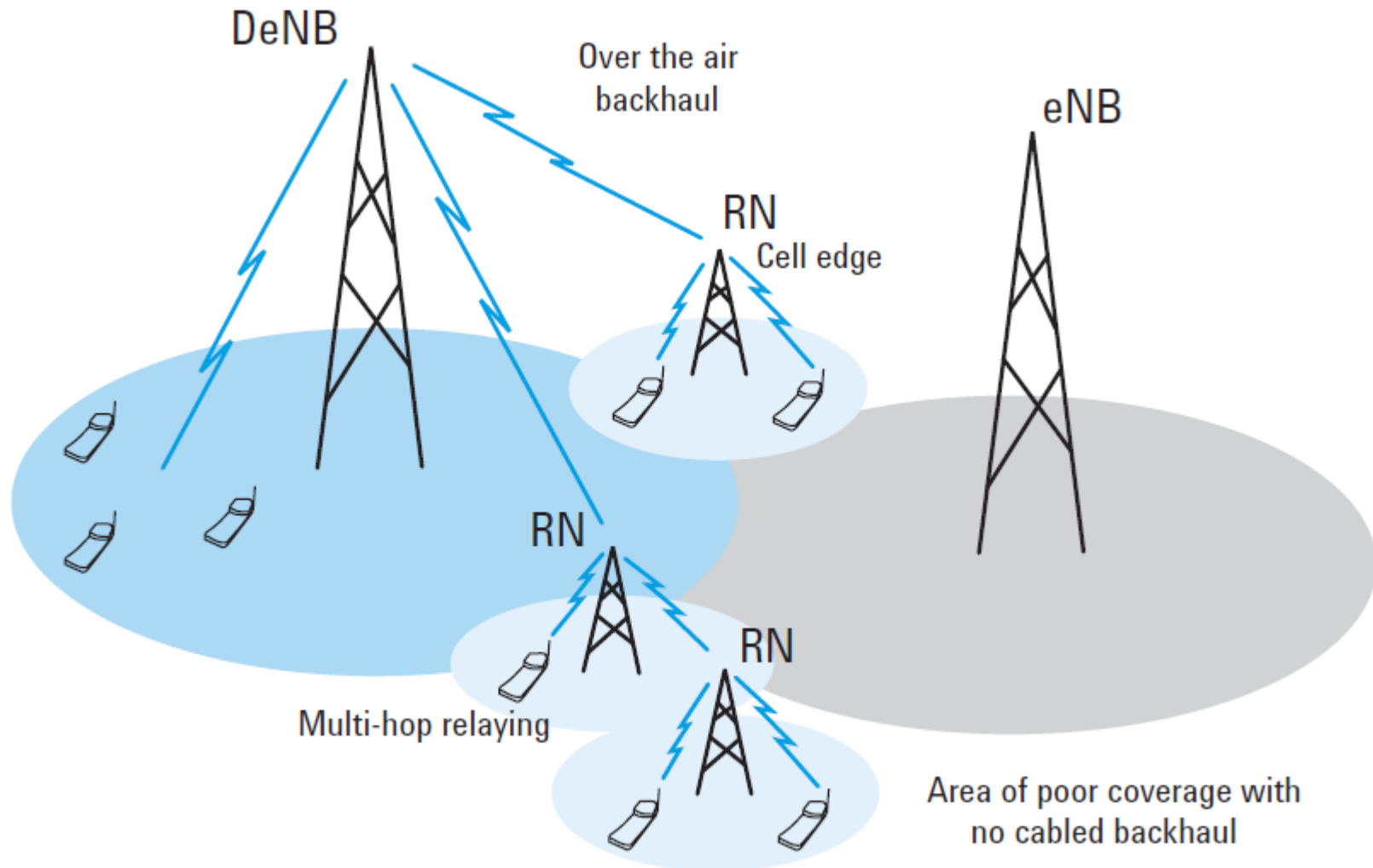



Where to use relaying

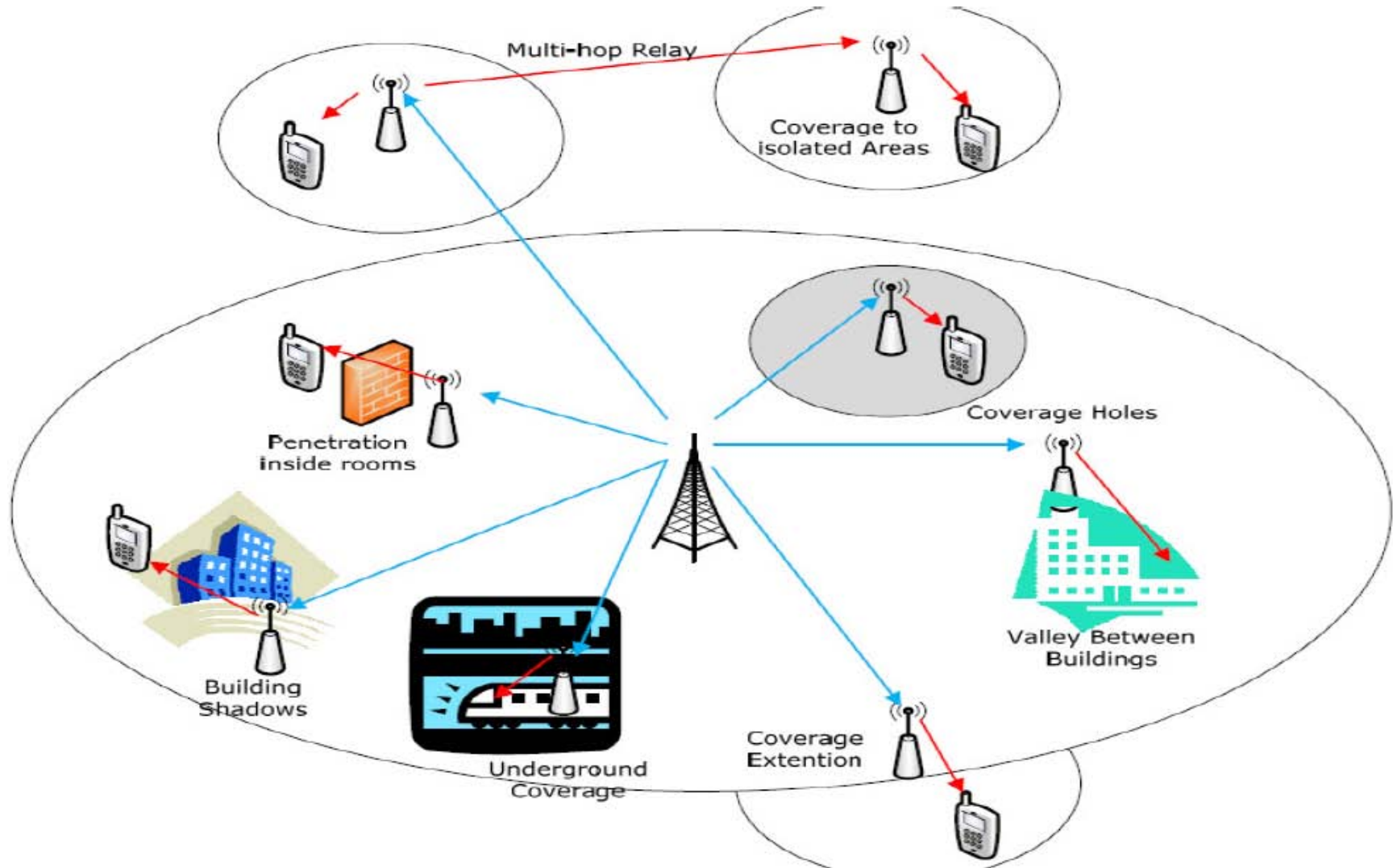

Co-ordinated Multipoint

■ CoMP

- Stands for Coordinated Multipoint Transmission and Reception
- Generally known as distributed MIMO or network MIMO

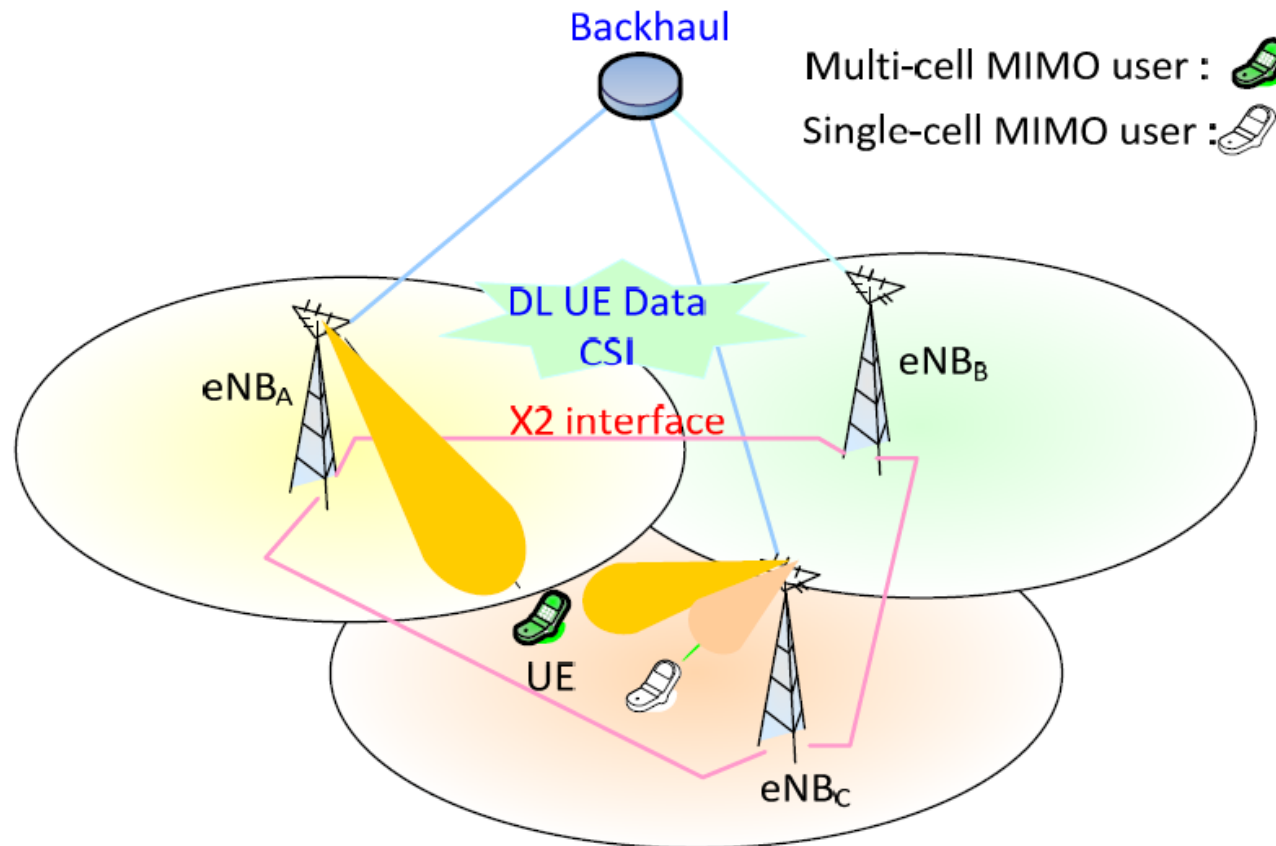

Co-ordinated Multipoint

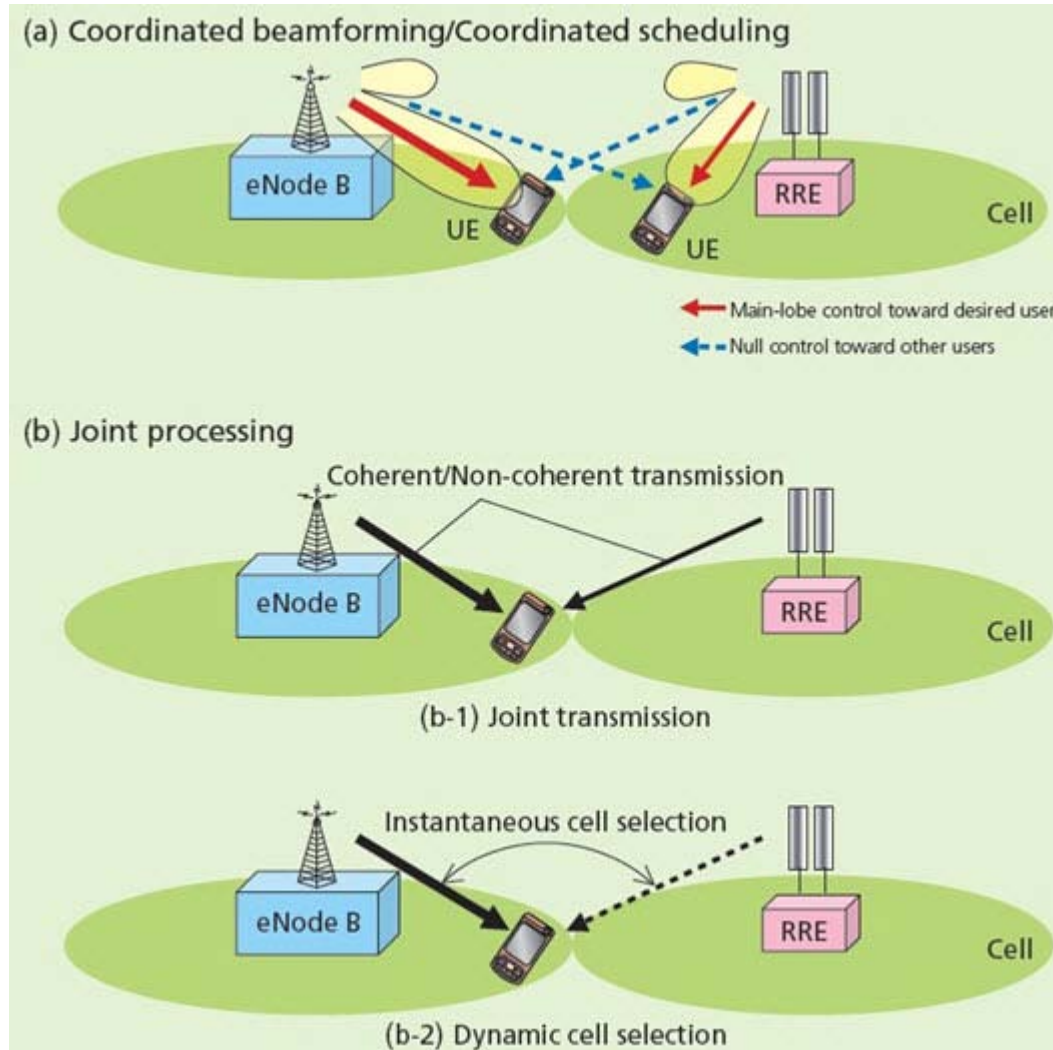

CoMP – Joint processing

- Joint Processing Coordinated Multipoint (JP-CoMP): data available at multiple cells. Two techniques:
- Multiple eNBs transmit to one UE using UE-specific reference signals:

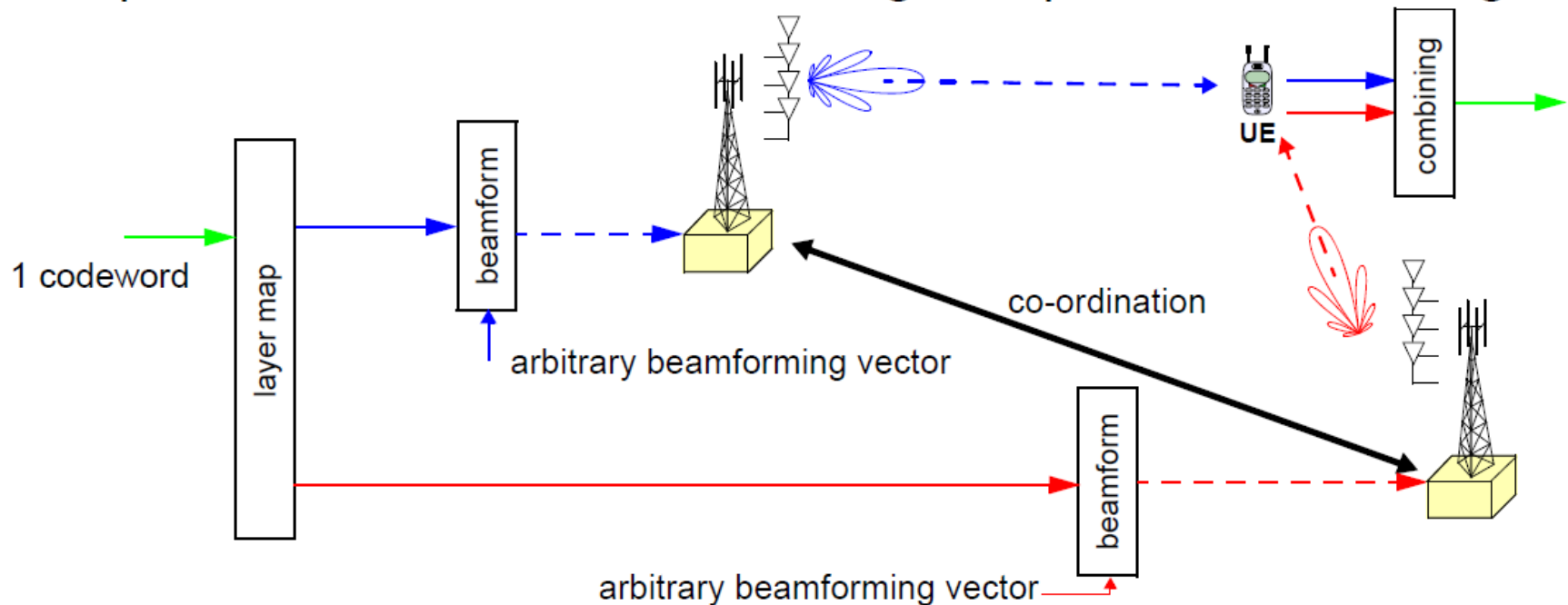

- eNB selection per transmission (UE connected to multiple eNB).

CoMP – CS/CB

- Co-ordinated scheduling / co-ordinated beamforming (CS/SB):
 - Data only available at one eNB;
 - eNBs jointly decide scheduling of transmission in time, frequency and space:

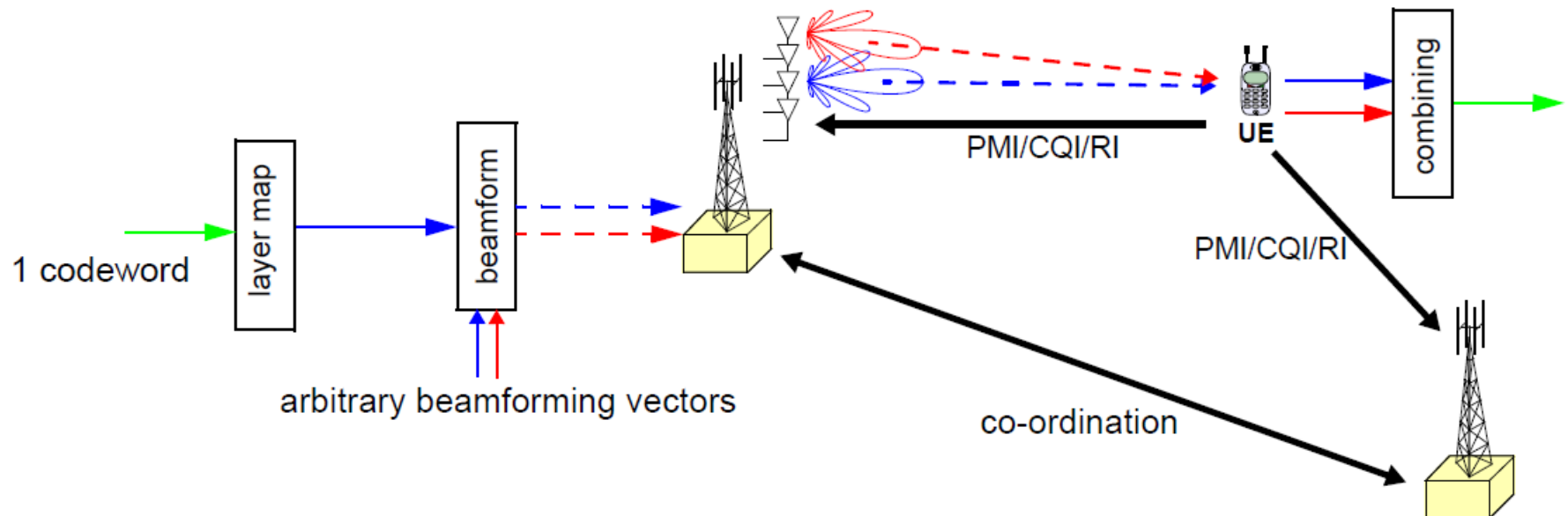

LTE-Advanced Improvements

- A schematic view on LTE-Advanced improvements

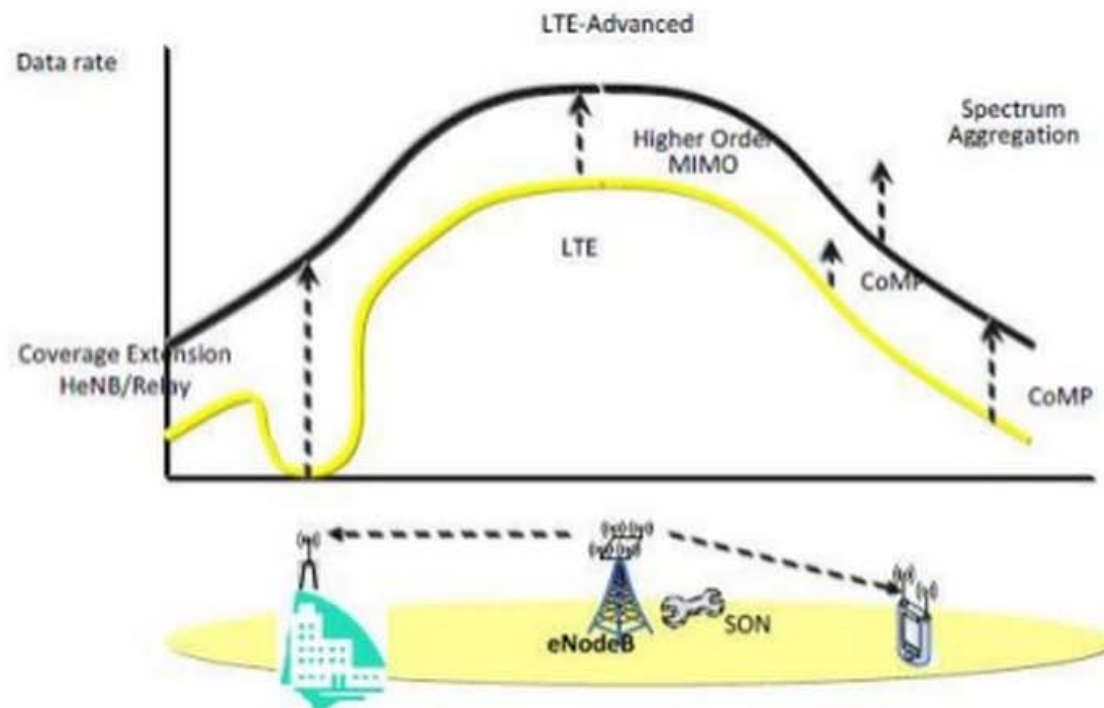



1999



2013

Release	Stage 3: Core specs complete	Main feature of Release
Rel-99	March 2000	UMTS 3.84 Mcps (W-CDMA FDD & TDD)
Rel-4	March 2001	1.28 Mcps TDD (aka TD-SCDMA)
Rel-5	June 2002	HSDPA
Rel-6	March 2005	HSUPA (E-DCH)
Rel-7	Dec 2007	HSPA+ (64QAM DL, MIMO, 16QAM UL). LTE & SAE Feasibility Study, Edge Evolution
Rel-8	Dec 2008	LTE Work item – OFDMA air interface SAE Work item – New IP core network UMTS Femtocells, Dual Carrier HSDPA
Rel-9	Dec 2009	Multi-standard Radio (MSR), Dual Carrier HSUPA, Dual Band HSDPA, SON, LTE Femtocells (HeNB) LTE-Advanced feasibility study, MBSFN
Rel-10	March 2011	LTE-Advanced (4G) work item, CoMP Study Four carrier HSDPA
Rel-11	Sept 2012	CoMP, eDL MIMO, eCA, MIMO OTA, HSUPA TxD & 64QAM MIMO, HSDPA 8C & 4x4 MIMO, MB MSR
Rel-12	March 2013 stage 1	New carrier type, LTE-Direct, Active Antenna Systems



Release 11: Stage 3 Frozen Sept 2012

Summary of Key Radio Features

New carrier aggregation combinations (18)

Verification of radiated multi-antenna reception performance of UEs in LTE/UMTS (MIMO OTA)

Signaling and procedure for interference avoidance for in-device coexistence

Coordinated multi-point operation for LTE

Public Safety Broadband High Power UE for Band 14, Region 2



LTE Release 12

Enhanced Small Cells

- higher order modulation
- dual connectivity
- cell discovery
- self configuration

Carrier Aggregation

- 2 uplink carriers
- 3 downlink carriers
- FDD/TDD carrier aggregation

MIMO

- 3D channel modeling
- elevation beamforming
- massive MIMO

New and Enhanced Services

- cost and range of MTC
- D2D communication
- eMBMS enhancements

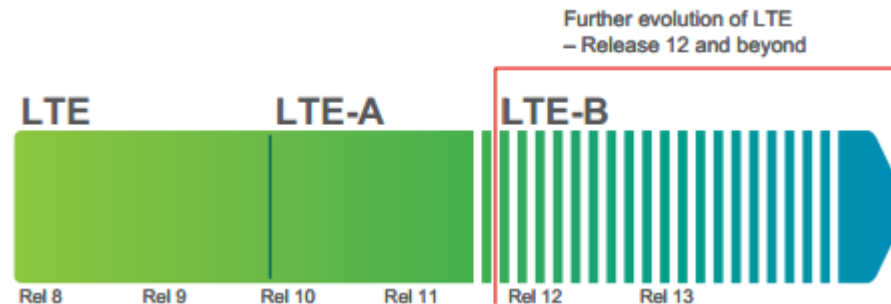



Thank you for your attention