



Introduction to Wireless/Mobile Communications



Lecture Contents

Mobile
communications
evolution

Course lectures

Local area
communications
evolution (WiFi)

Metropolitan area
communications
evolution (WiMaX)

Typical
Transmission
methods and
access control





The beginning of mobile communications



It all started 100 years ago

Heinrich Hertz, 1857-1894

- Electromagnetic waves 1887



Reginald Fessenden 1866-1932

- Voice transmission over radio 1906



Guglielmo Marconi 1874-1937

- First radio 1897

Mobile Communications at the beginning of the 21st century

1910: Ericsson & wife Hilda



1924: First mobile radio telephone



Courtesy of Rich Howard



Cellular Network Generations

- It is useful to think of cellular Network/telephony in terms of *generations*:
 - 0G: Briefcase-size mobile radio telephones
 - 1G: *Analog* cellular telephony
 - 2G: *Digital* cellular telephony
 - 3G: *High-speed* digital cellular telephony (including *video telephony*)
 - 4G: IP-based “anytime, anywhere” voice, data, and multimedia telephony at *faster* data rates than 3G



Evolution of Cellular Networks

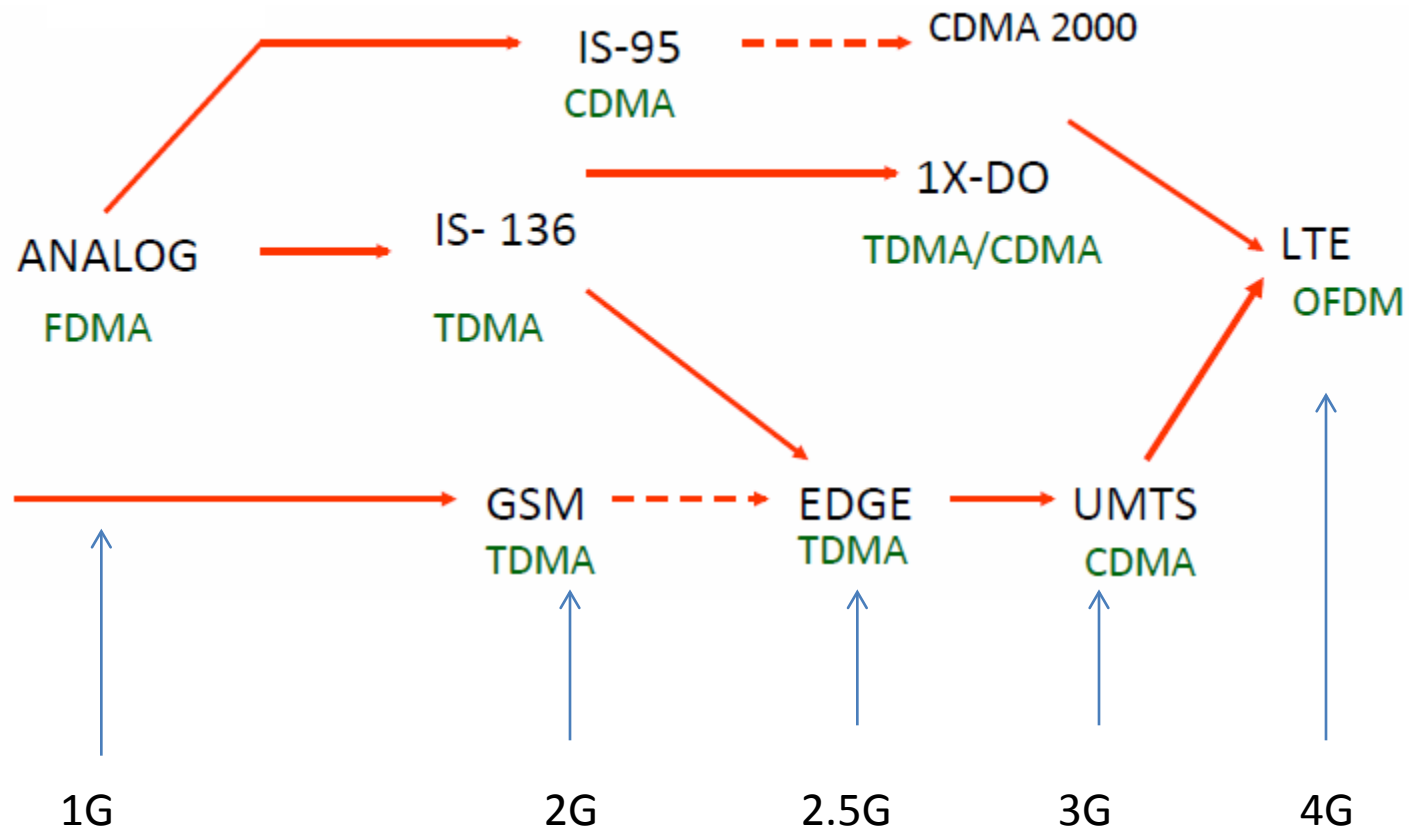

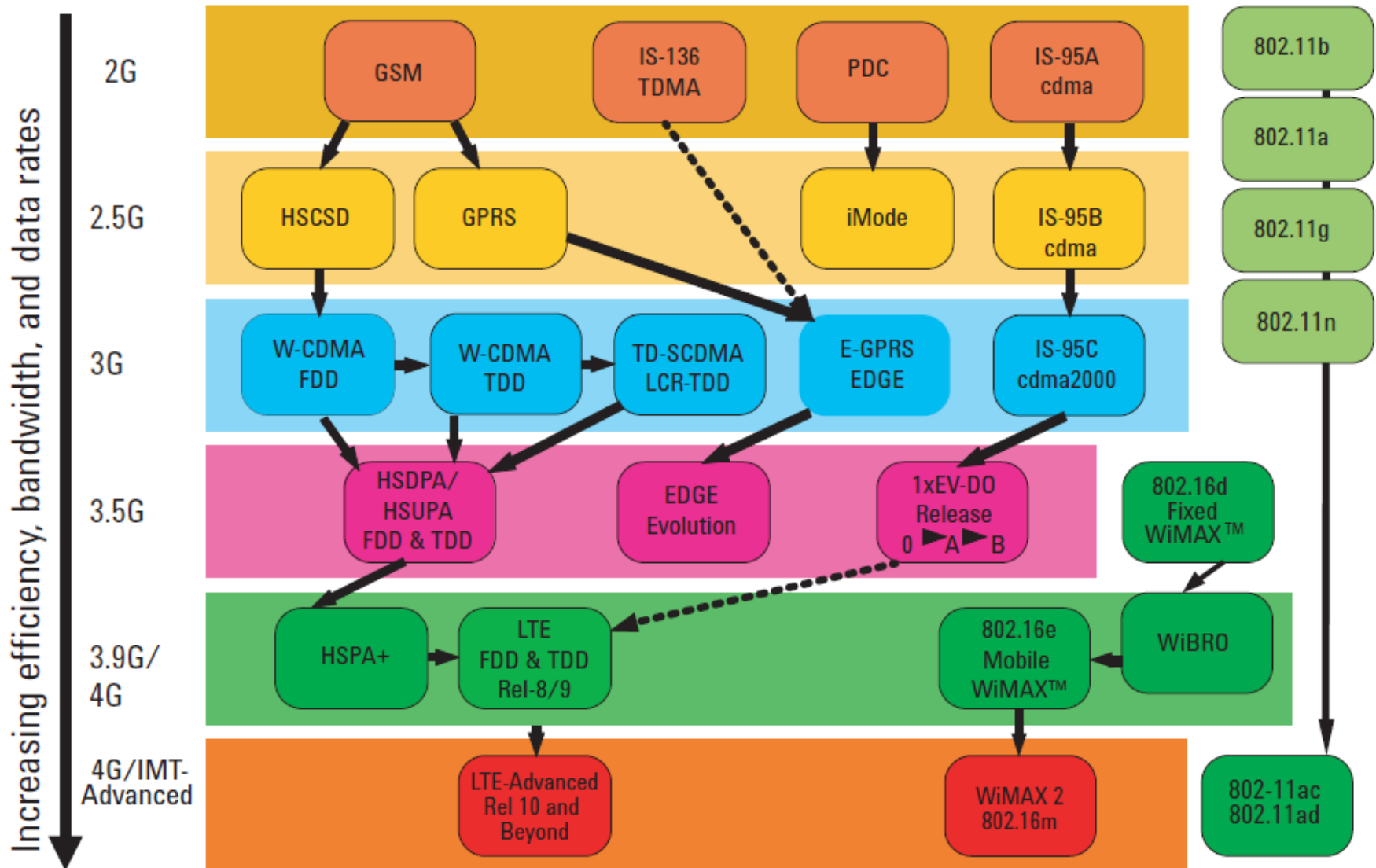



Evolution of terminals and services

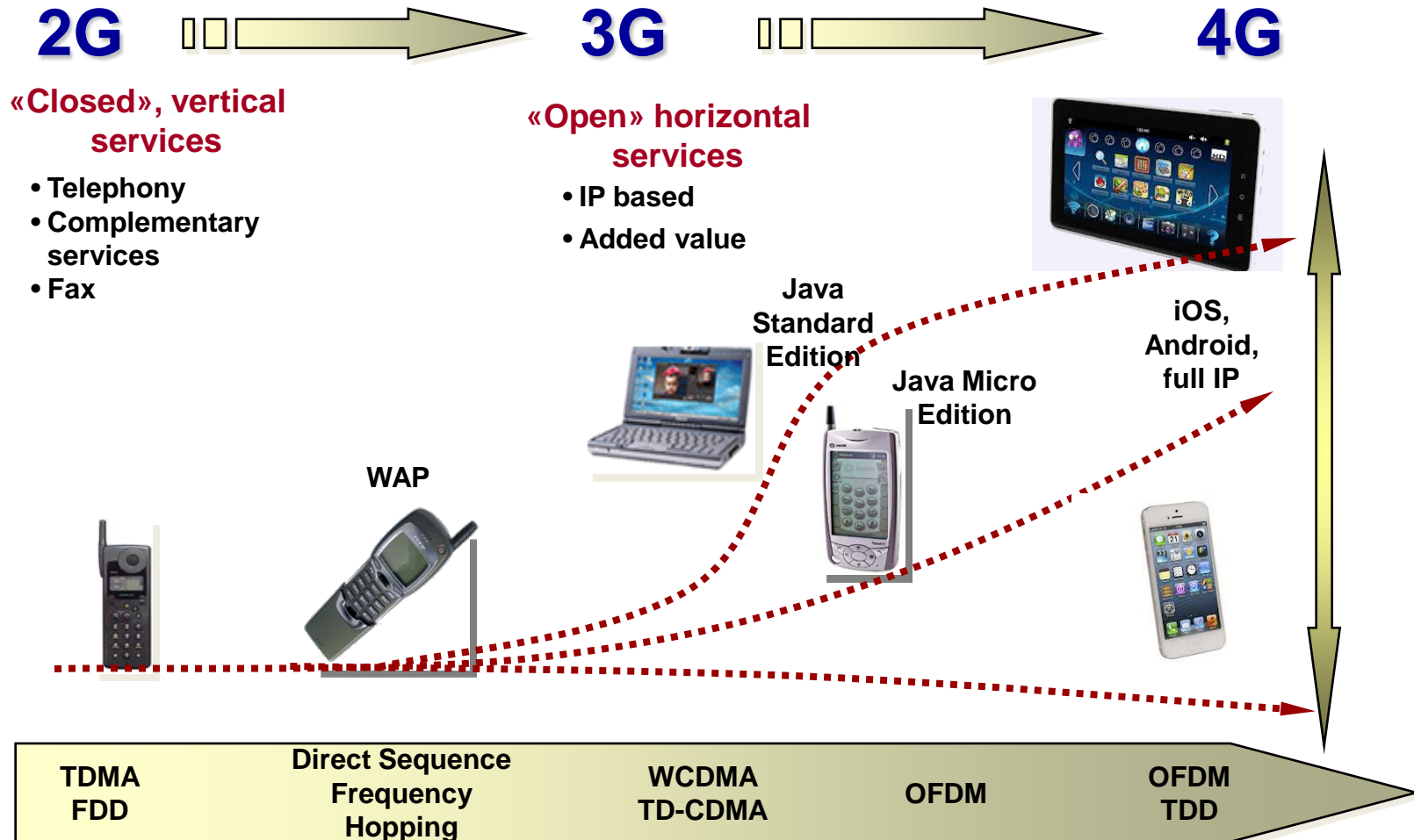



Business model evolution

2G



3G



4G

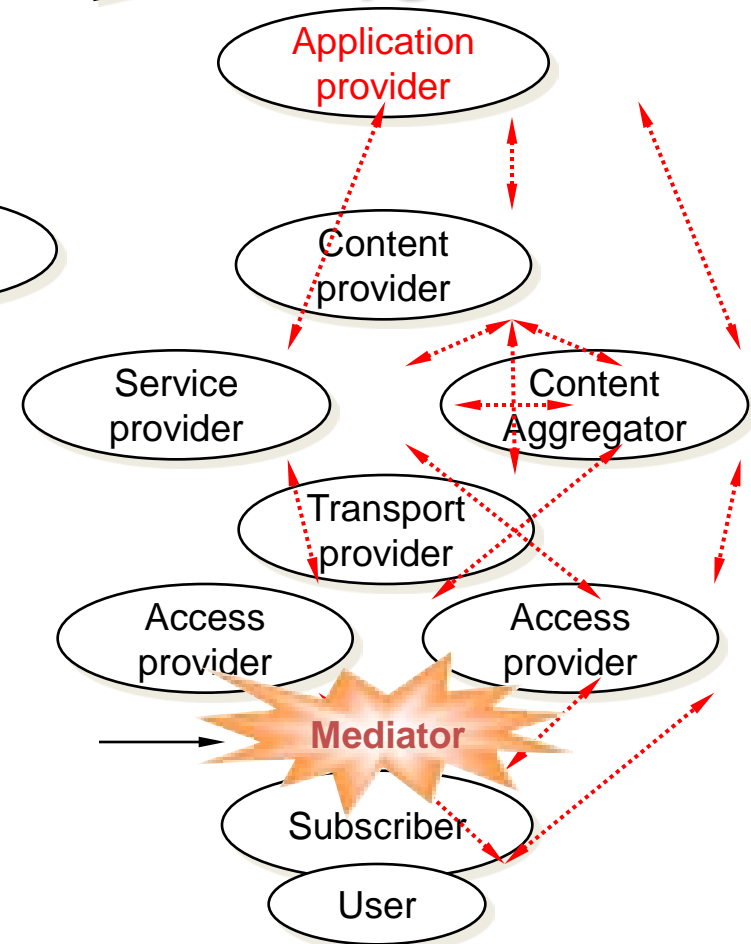
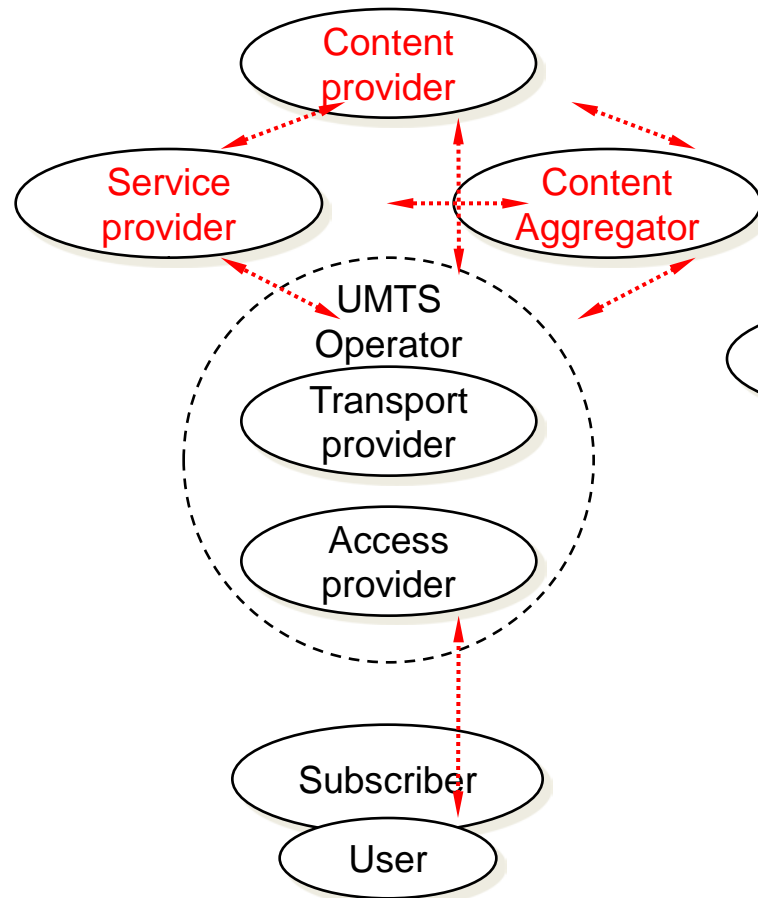
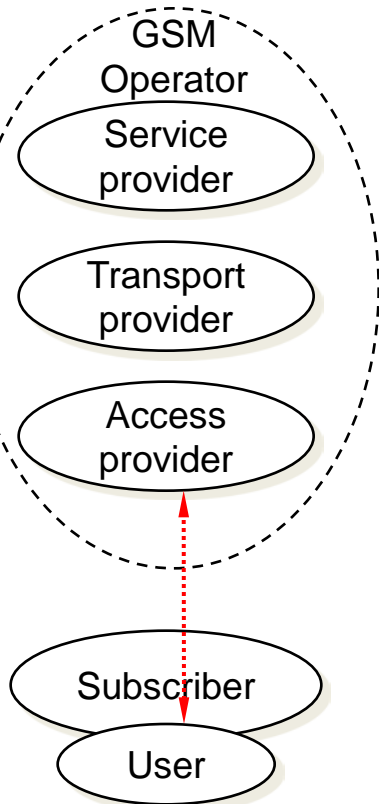



Wireless Standards

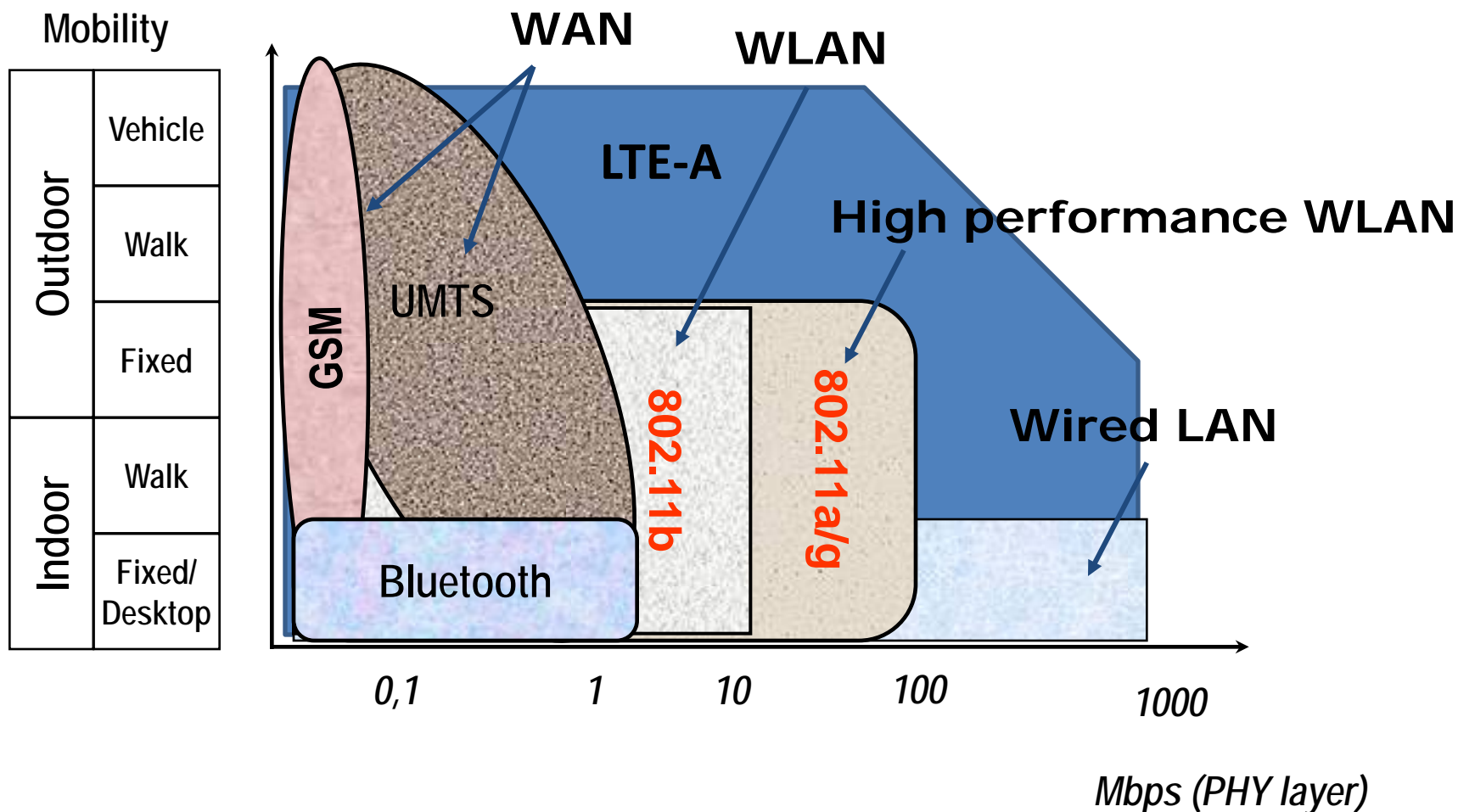



Forthcoming lectures

1. LTE Basics
2. Mobility management in LTE-A
3. Energy saving in LTE-A
4. Interference management in LTE-A
5. Quality of service and quality of experience in LTE-A
6. Device-to-device communications in LTE-A
7. Support for new network applications in LTE-A
8. Security mechanisms for 3G/4G mobile networks
9. Radio resource management in wireless/mobile networks
10. Satellite communications and interworking with mobile networks



1. LTE basics

- Mobile standards evolution towards 4G
GSM->GPRS->UMTS->LTE->LTE-A
- Key features of Long Term Evolution (LTE)
- LTE architecture / components / functionality
- LTE transmission techniques
- LTE-Advanced enhancements



Evolution of Radio Access Technologies

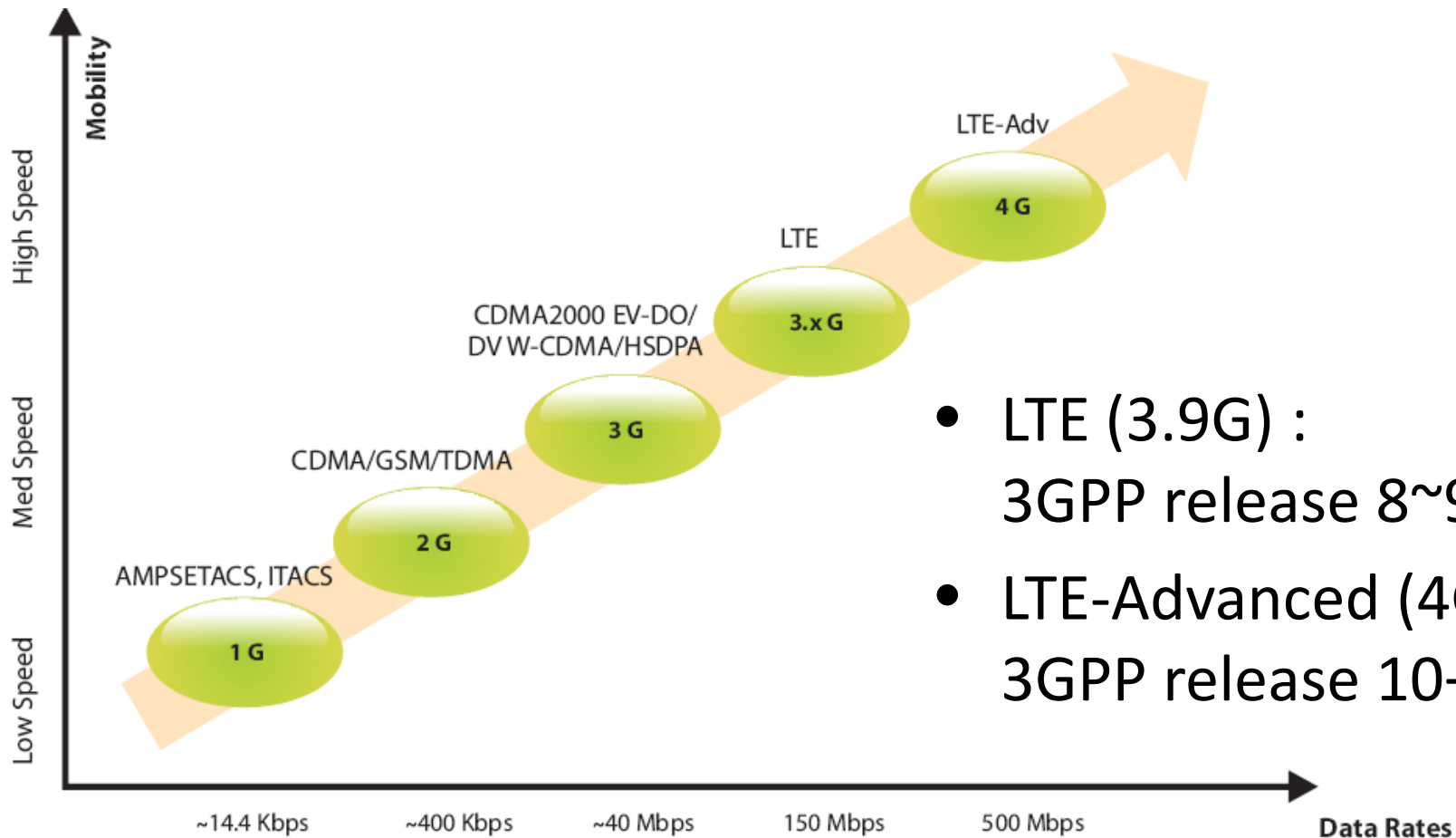

- LTE (3.9G) :
3GPP release 8~9
- LTE-Advanced (4G):
3GPP release 10+

2. Mobility management in LTE-A

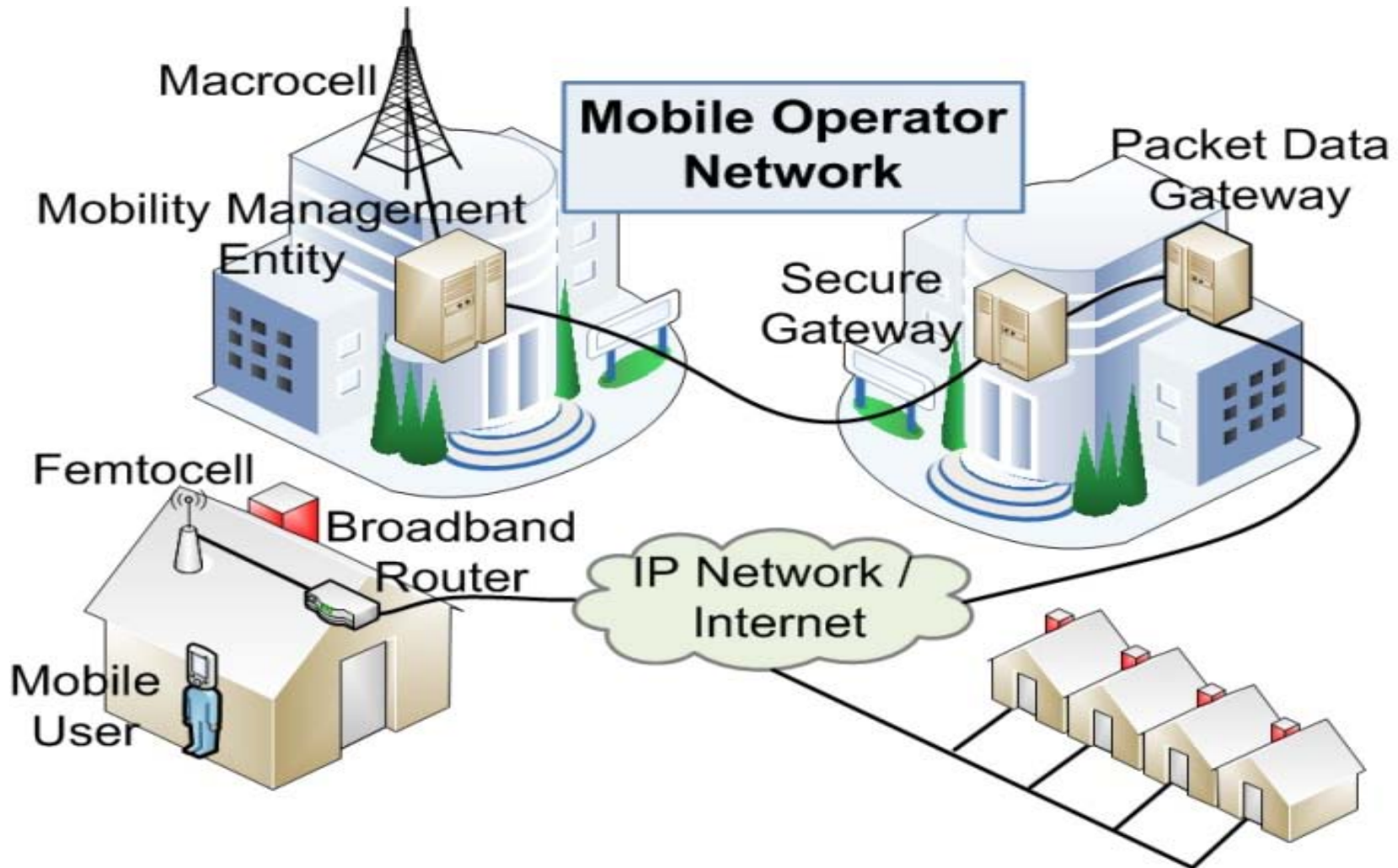



Focus of the lecture

- Motivation
- Support of femtocells in LTE-A
- Key aspects and **research challenges**
 - Cell search
 - Cell selection / Reselection
 - Handover decision
 - Handover execution
- **Handover decision** for femtocells in LTE-Advanced (LTE-A)
 - Handover decision **criteria** and context
 - Classification and **survey** of handover decision algorithms
 - Comparative **summary** and future research directions



3. Energy saving in LTE-A

- The use of devices such as **smart phones, tablets** etc. , is widespread.
- Inevitably user expectations also rise in terms of **higher data rates**, instant internet connectivity and a much larger variety of applications to play with.
- Higher speed data transmission or reception requires **higher power consumption**; this in turn drains the battery quickly.
- To support battery-operated mobile devices, LTE has developed **energy-saving features** that allow mobile device to operate for longer durations without having to recharge.



Focus of the lecture

- Motivation
- Component-Level Energy Saving
 - **Energy consumption model** for component-level energy saving
 - **Opportunities** for component-level energy saving for femtocells
- System-Level Energy Saving
 - **Energy consumption model** for system-level energy saving
 - **Opportunities** for system-level energy saving for femtocells
 - Performance **comparison** of system-level energy saving approaches
 - Research **directions**

4. Interference management in LTE-A

Heterogeneous environment - Different types of interference

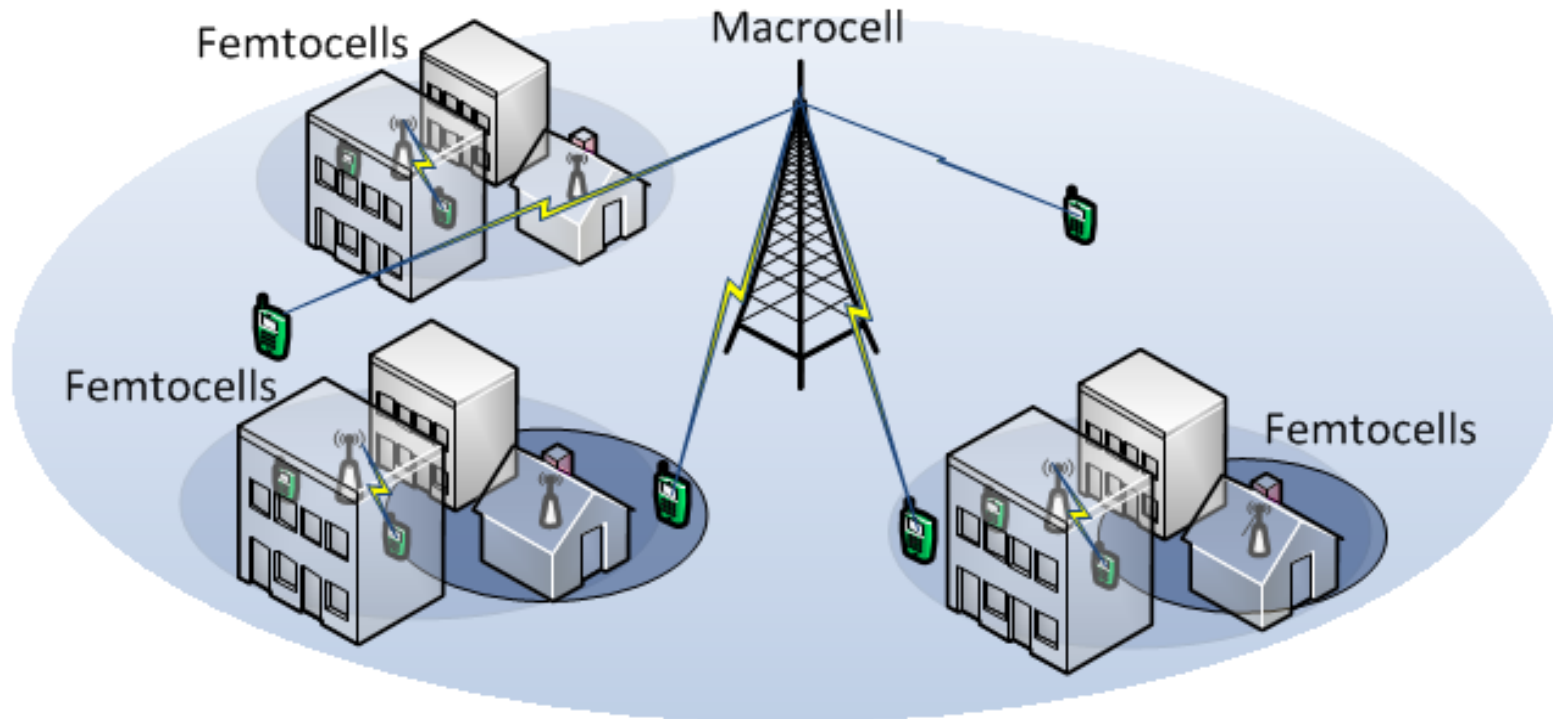



The Interference problem in Femtocell-Overlaid LTE-A networks

LTE-A provides a series of tools-technologies that can be used for Interference Management (IM):

- Enhanced inter-cell **interference coordination** (eICIC)
- Multiple Input Multiple Output (**MIMO**) antennas
- Coordination Multipoint (**CoMP**) transmission/reception
- Interference cancelation (**IC**)

And, of course, we can use

- Interference-aware **power control** (PC)/**resource allocation** (RA)

The question that arises is **how, when, and under what circumstances** we can exploit these tools!

The Interference problem in Femtocell-Overlaid LTE-A networks

During the interference management lecture we will deal with:

- The LTE-A **tools/technologies** that are related with the interference management
- The **state-of-the-art approaches** for interference management
- The interference management in **control channels**
- The relation between **interference and QoE**

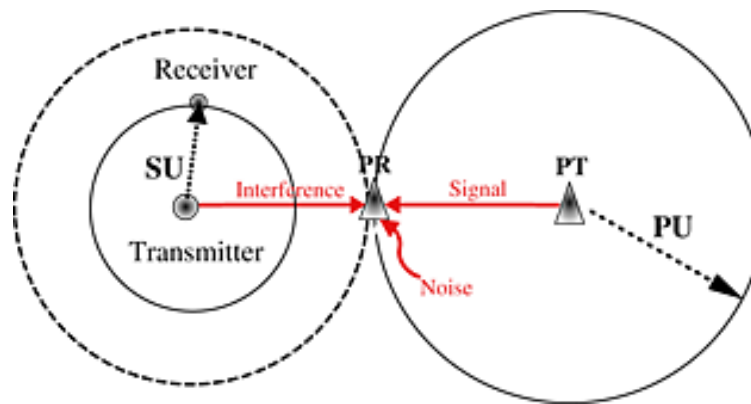



5. Quality of service and quality of experience in LTE-A

Why the study of the QoE is important?

- The QoE encompasses the issue of the **user's decision on retaining a service** (and keep paying for it) or giving it up
- It is more efficient to **focus on guaranteeing QoE** than promising high QoS
 - Obviously, high QoS results in high QoE, however the quantification of this relation may be useful from the perspective of **saving network resources or providing QoE-centric services**
- QoE is the most reliable way to **evaluate real time services** such as VoIP and video conference which are currently used by more and more people



5. Quality of service and quality of experience in LTE-A

What are the main challenges in studying QoE?

- **QoE estimation**
 - Can be based on **subjective** or **objective methods**. How to assure the reliability of subjective methods and how to map objective parameters to QoE?
- **QoE monitoring**
 - Find user-transparent and **passive ways to feed QoE measures** back to the core network
- **QoE management**
 - How QoE variations can **drive the resource, interference and mobility management?**

6. Device-to-device communications in LTE-A

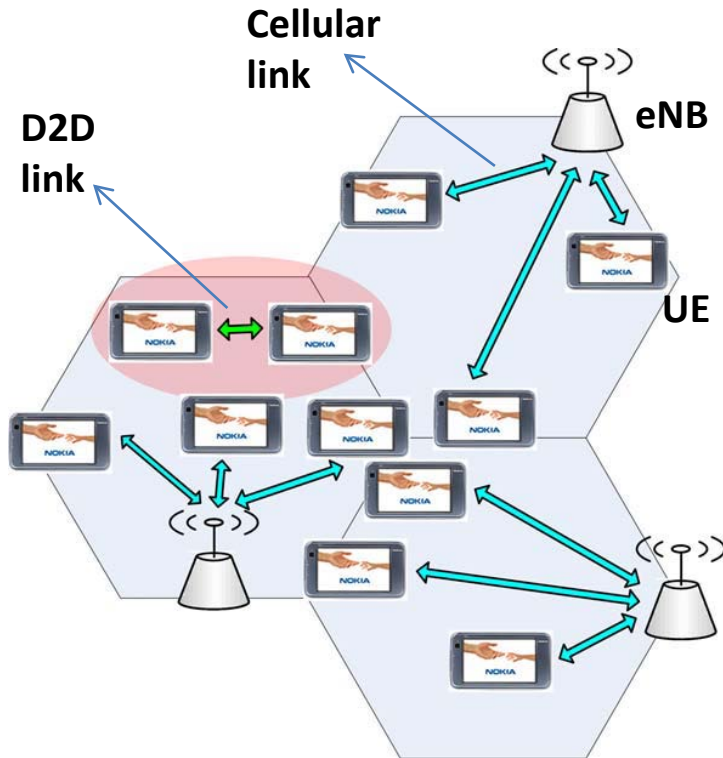

Why D2D?

- Higher **throughput**, lower **delays**, reduced **power consumption**
 - Increased **spectrum utilisation**
 - eNB **offloading** and network decongestion
 - All benefits of centralised eNB control (higher security etc.)
 - **New service** opportunities
 - Can be **transparent** to the user
- D2D is ideal for **short range data intensive** peer-to-peer communications, e.g. games, video streaming etc.

- Focus on:
- **Network-assisted** D2D links
 - Utilising **licensed** spectrum
 - **Direct** pair communication

Main research issues

- Intra- and Intercell **interference mitigation** (co-existence of cellular & D2D links): Power control optimisation mechanism for D2D, Exploitation of proximity/neighbourhood information etc.
- Radio **resource management** (Resource Blocks allocation)
- Comparison between **cellular and D2D performance**
- D2D **session setup and management**
- Peer **device and service discovery** techniques

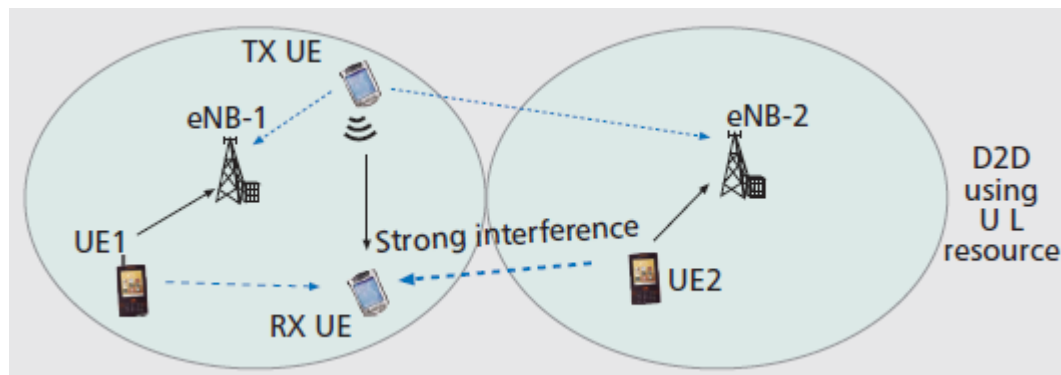

7. Support for new network applications in LTE-A

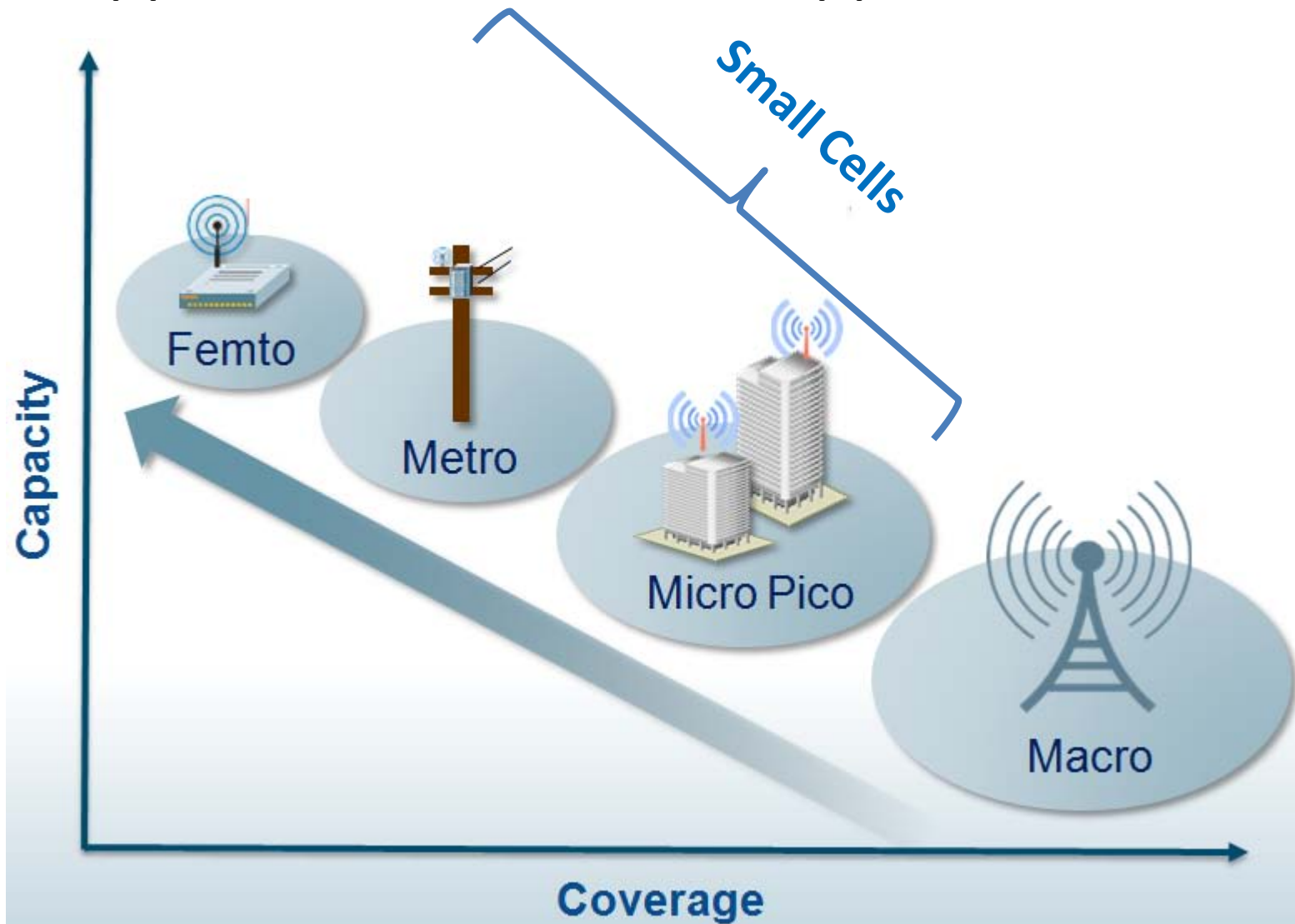



Why Small Cell Services?

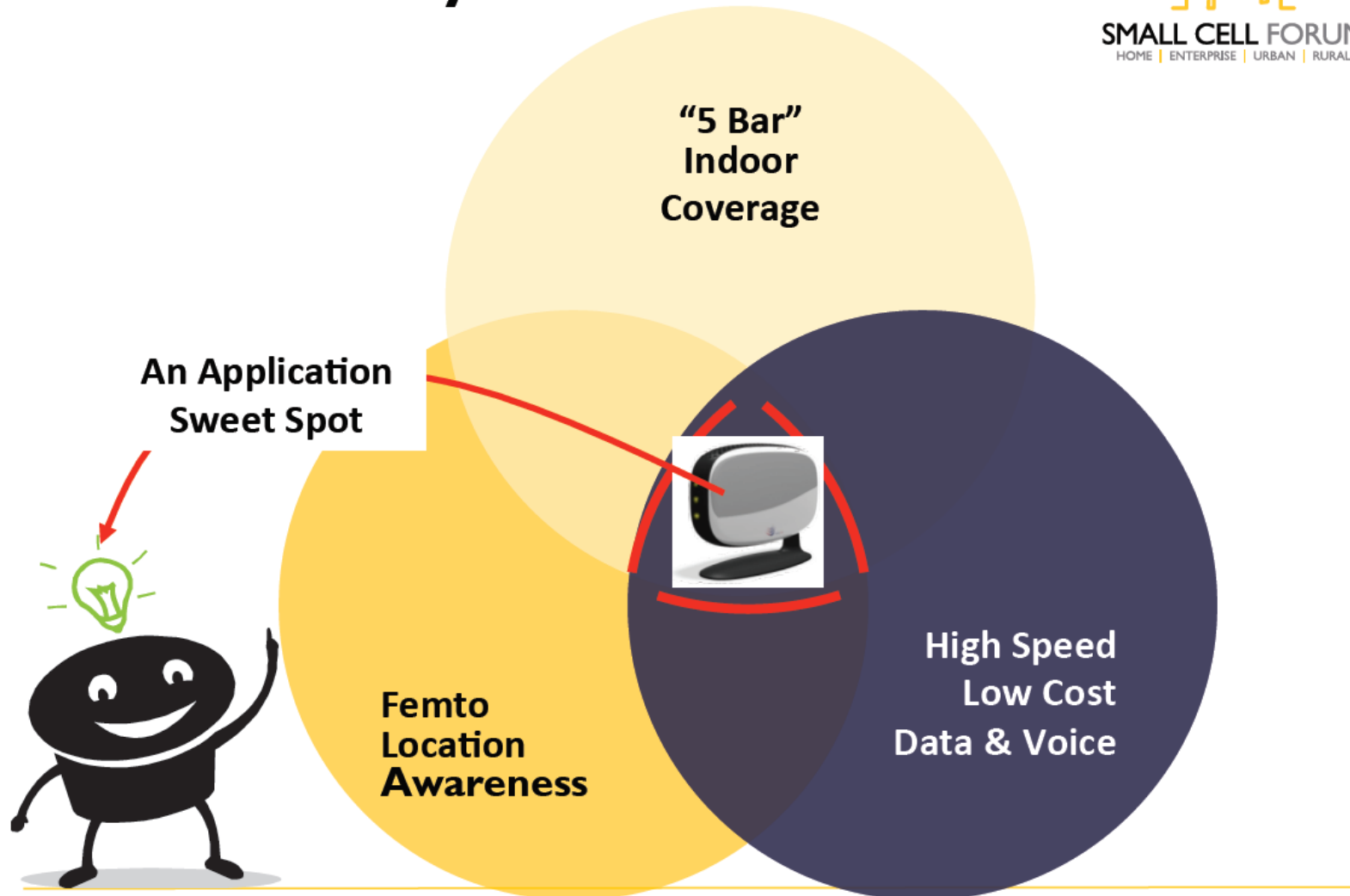

Femtocell is the main focus

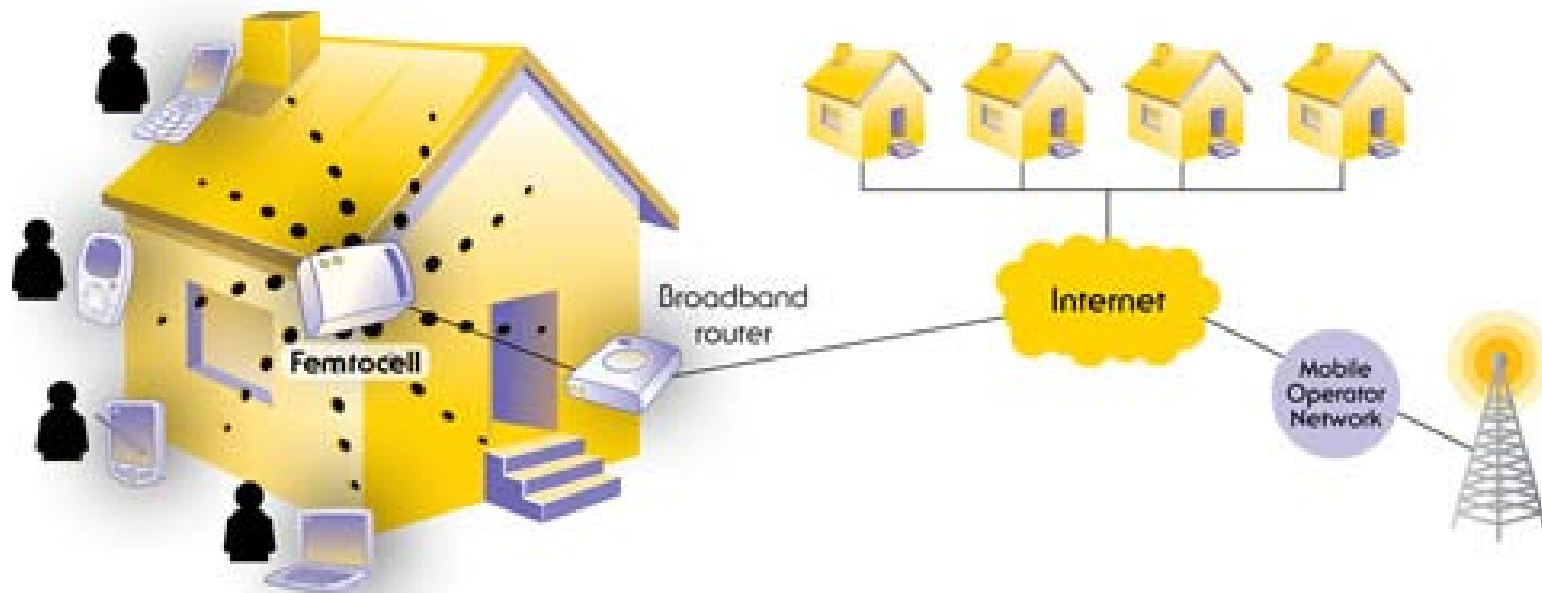

Residential services

Mother leaves a note for the first arriving family member.
Jamie gets home and receives an SMS from Mom saying...

Other Channels: Social Media,, etc.

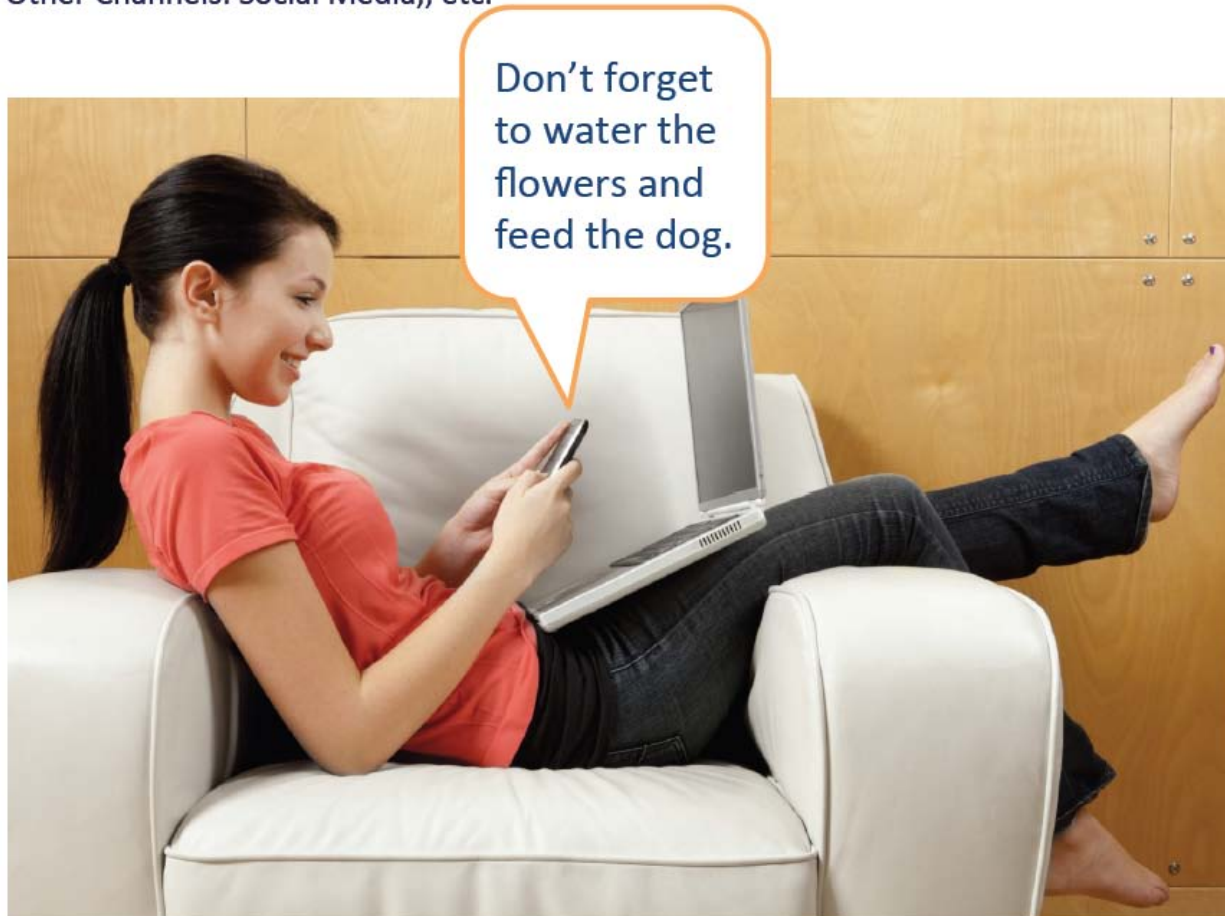



Targeted Advertisements

FREE DRINK
with purchase
of Large
Popcorn

FREE Small
Popcorn with
purchase of
drink.

FREE Small
Popcorn with
purchase of
drink.

FREE DRINK
with purchase
of Large
Popcorn

Movies – frequent movie goers receive targeted promotional messages.



Need for an architecture

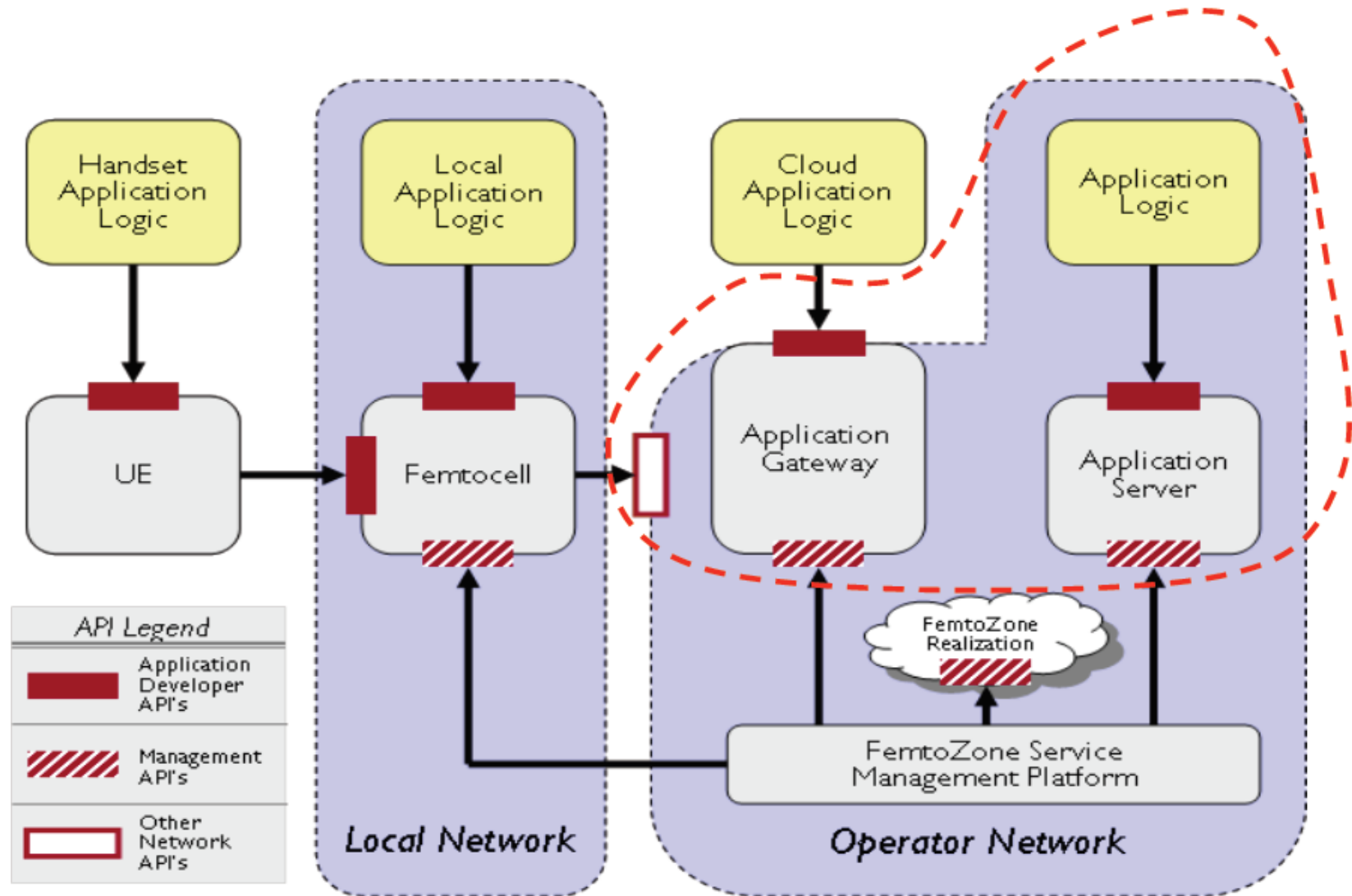



Contents of the lecture

- **Capabilities** to support new applications in LTE networks
- **How** small cell applications work
- **Categories** of small cell applications
- Focus on femtocells and **LTE**
- Femtozone service **architectures**
- **APIs** for femtocell applications
- Real working **developments**



8. Security mechanisms for 3G/4G mobile networks

- Security **architectures** for mobile networks
- Security **services** provided
 - User Identity **Confidentiality**
 - User and Network **Authentication**
 - **Keying** material generation
 - User data and signaling confidentiality and **integrity** protection
- Network domain security **services** designed for future networks
- Security **Weaknesses** and Vulnerabilities
- Possible **Attacks** and their Impact



9. Radio resource management in wireless/mobile networks

- Synchronous wireless networks important **characteristics**
 - Frequency band
 - MAC architecture
 - Transmission scheme
 - Modulation
- Multiple access schemes
 - Single Carrier
 - OFDM
 - OFDMA
 - SC-OFDMA
- Point-to-multipoint & mesh architectures



Resource Management – Theory vs reality

- How **QoS affects** scheduling & resource management
- **Importance of resource management** for wireless networks efficiency
- **Commonly used algorithms** for scheduling & resource allocation
- **Complexity** vs performance
- **ISP's** point of view
- **Customer's** (Public/Civil/Military/Industry) point of view
- Case study on **WiMaX**

10. Satellite communications and interworking with mobile networks

- Challenge to handle **long propagation delays** (125ms)
- **DVB-RCS** (Digital Video Broadcasting - Return Channel via Satellite)
- **Why interconnect** broadband wireless networks and satellite networks?
 - Advantages – Applications
 - Problems

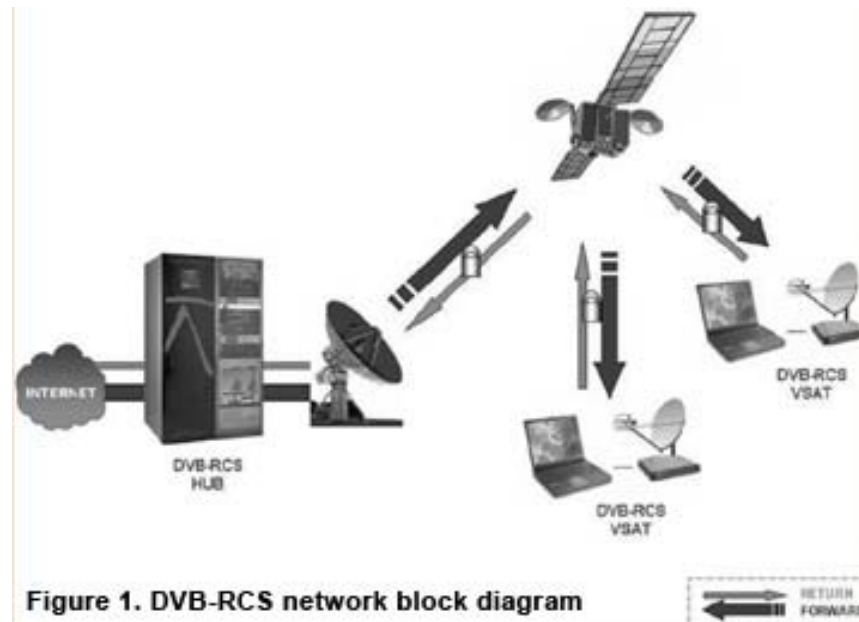

Case Study : Interconnection of WiMAX with satellite networks

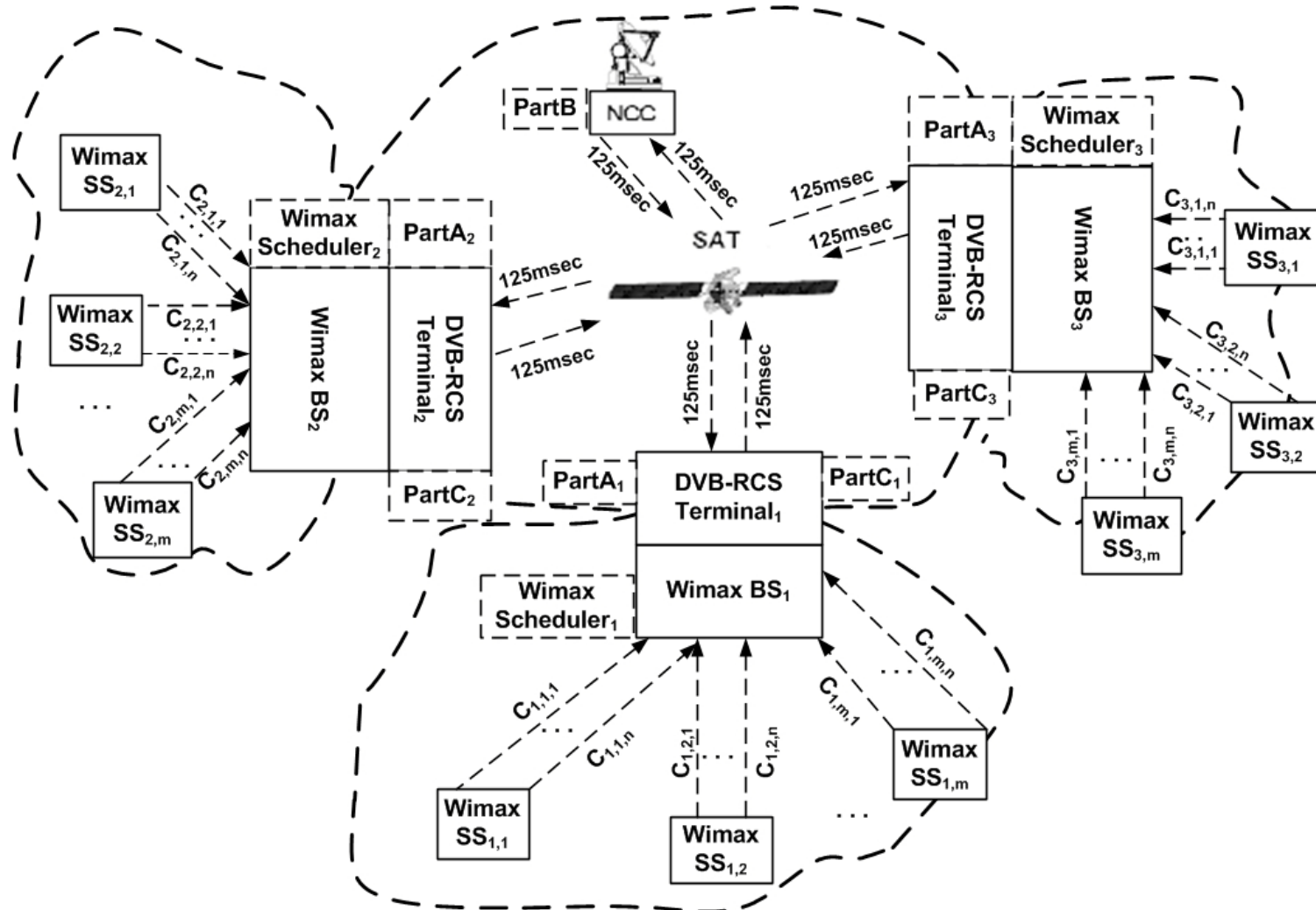



TCP/IP Reference Model

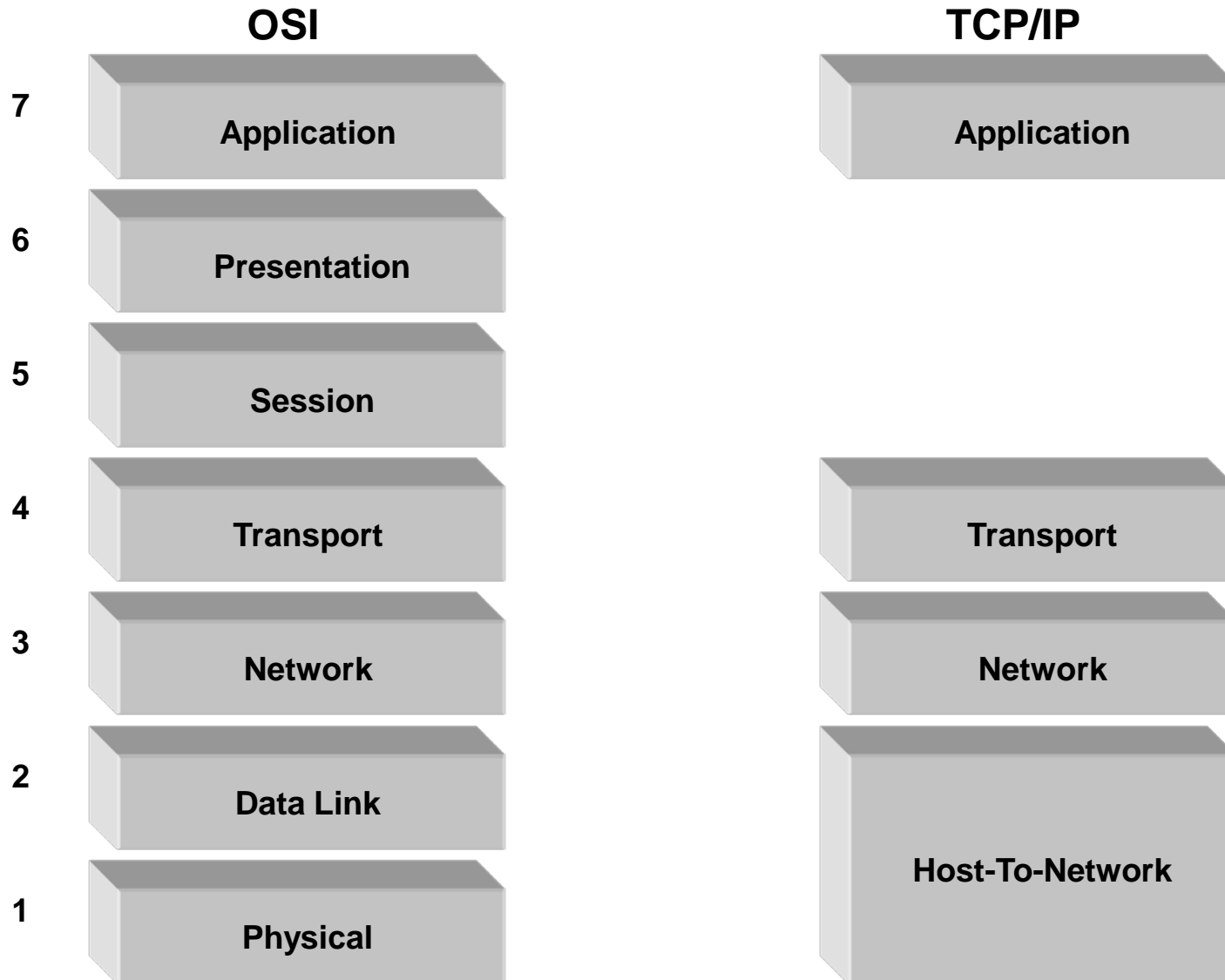

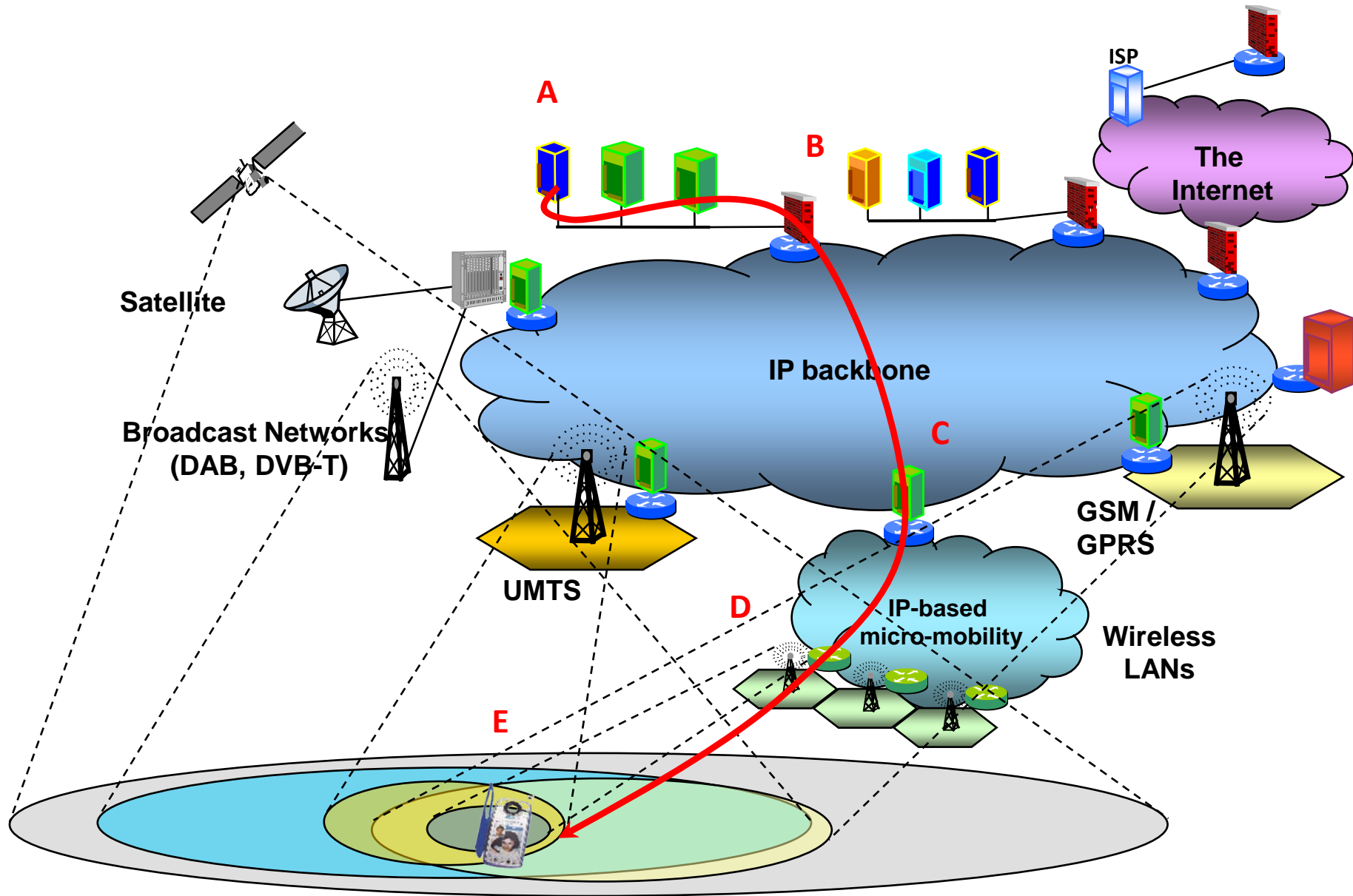



A



E

HTTP

HTTP

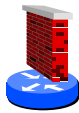

B

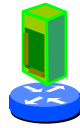

C



D

TCP

TCP

IP

IP

IP

IP

IP

Ethernet

Ethernet

Ethernet

Ethernet

Ethernet

Ethernet

802.11 MAC

802.11 MAC

Coaxial

Coaxial

Fiber-Optic

Fiber-Optic

Coaxial

Coaxial

802.11 PHY

802.11 PHY



Electromagnetic Spectrum

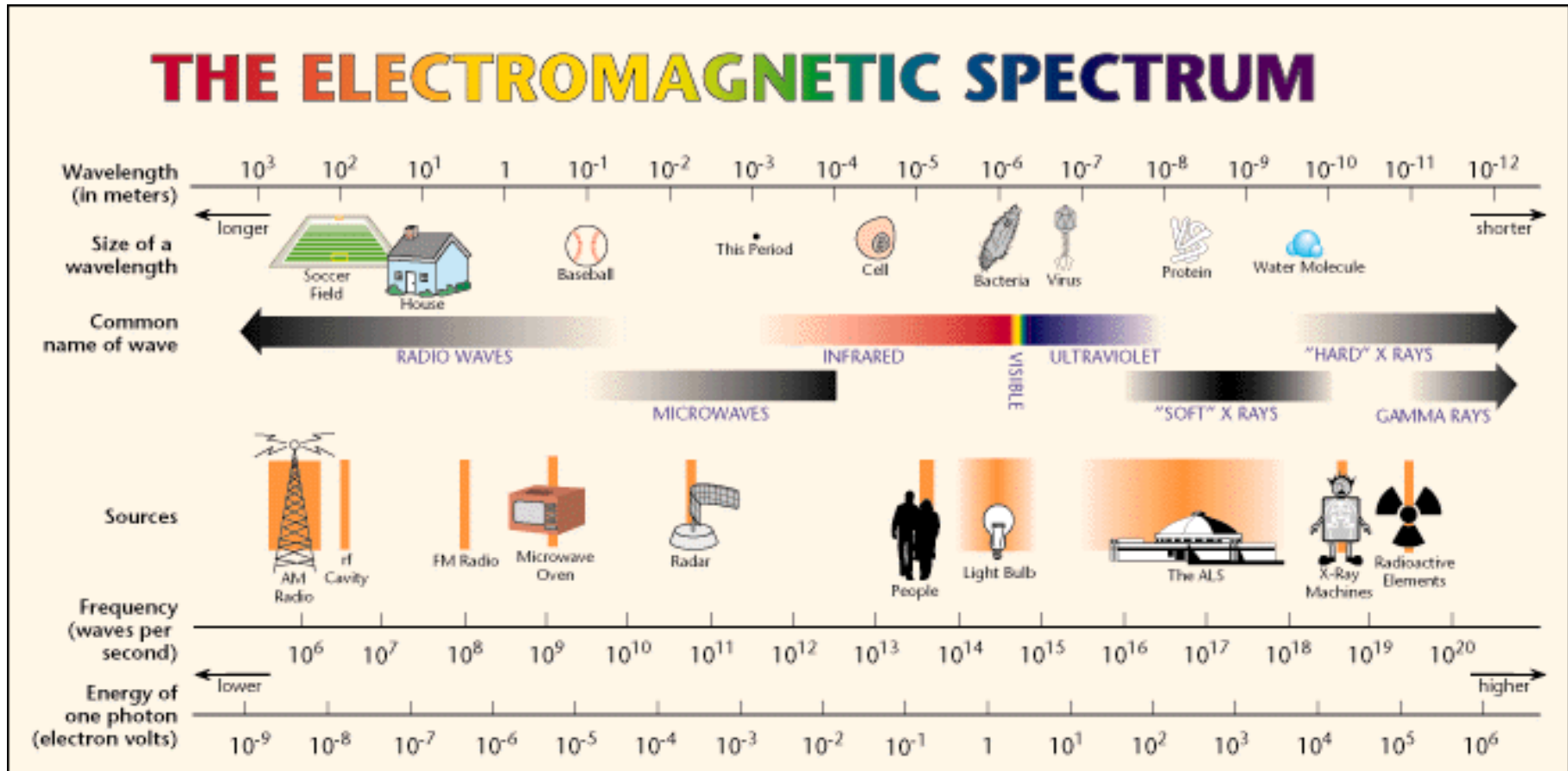

ISM Band (Industrial Scientific Medical)

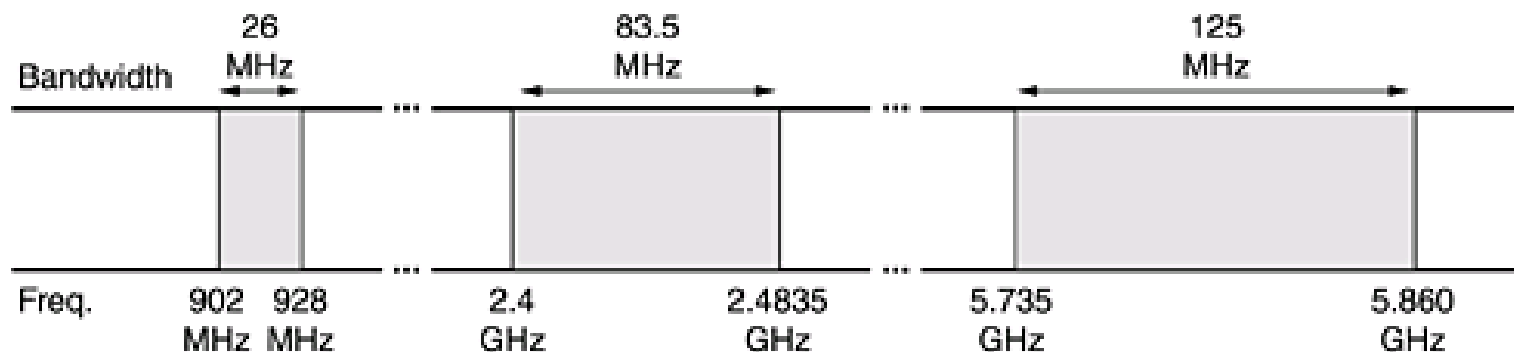

- Unlicensed, free to use
- Mainly used for WLANs



The Multiple Access Problem

- The base stations need to serve many mobile terminals **at the same time** (both downlink and uplink)
- All mobiles in the cell need to **transmit** to the base station
- **Interference** among different senders and receivers
- So we need multiple access scheme, to control transmissions from/to mobile terminals

Multiple Access Schemes

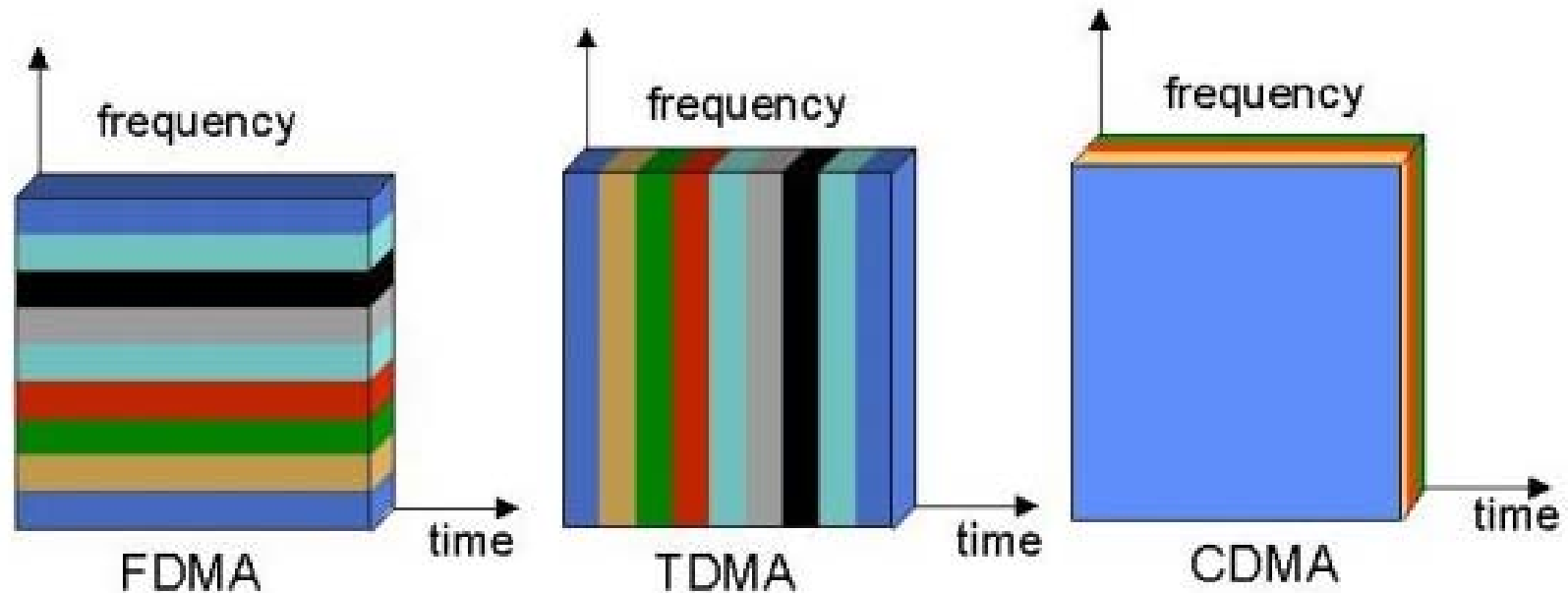

3 orthogonal Schemes:

- Frequency Division Multiple Access (FDMA)
- Time Division Multiple Access (TDMA)
- Code Division Multiple Access (CDMA)

Frequency Division Multiple Access

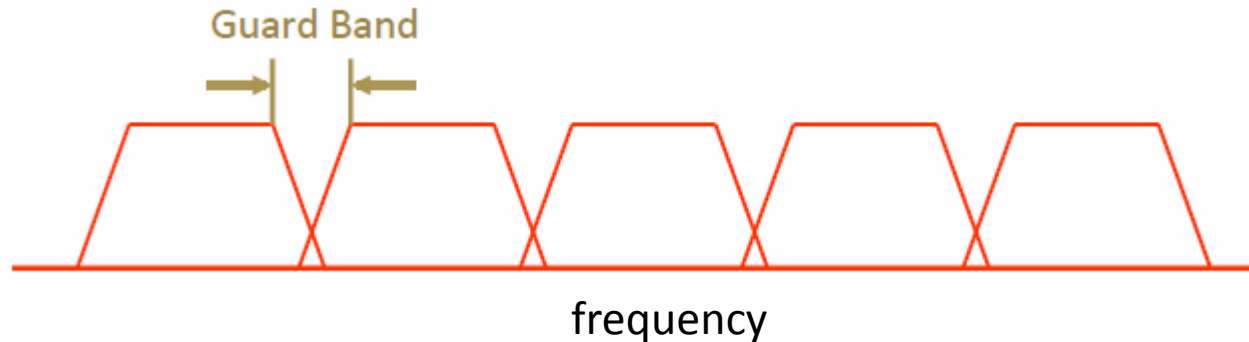

- Each mobile is assigned a **separate frequency** channel for the duration of the call
- Sufficient **guard band** is required to prevent adjacent channel interference
- Usually, mobile terminals will have **one downlink** frequency band and **one uplink** frequency band
- Different cellular network protocols use **different frequencies**
- Frequency is a **precious and scarce resource**. We are running out of it



Time Division Multiple Access

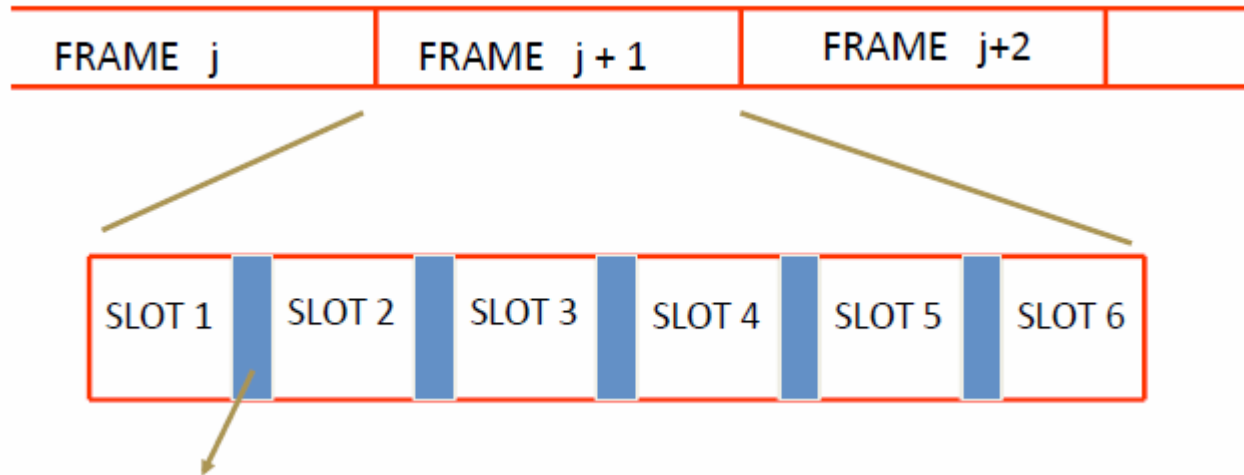

Guard time – signal transmitted by mobile terminals at different locations do not arrive at the base station at the same time

- Time is divided into slots and only **one mobile terminal transmits during each slot**
 - Like during the lecture, only one can talk, but others may take the floor in turn
- Each user is given a specific slot. No competition in cellular network
 - Unlike Carrier Sensing Multiple Access (CSMA) in WiFi



Code Division Multiple Access

- Use of **orthogonal codes** to separate different transmissions
- Each symbol of bit is transmitted as a larger number of bits using the user specific code – Spreading
 - Bandwidth occupied by the signal is much larger than the information transmission rate
 - But all users use the same frequency band together

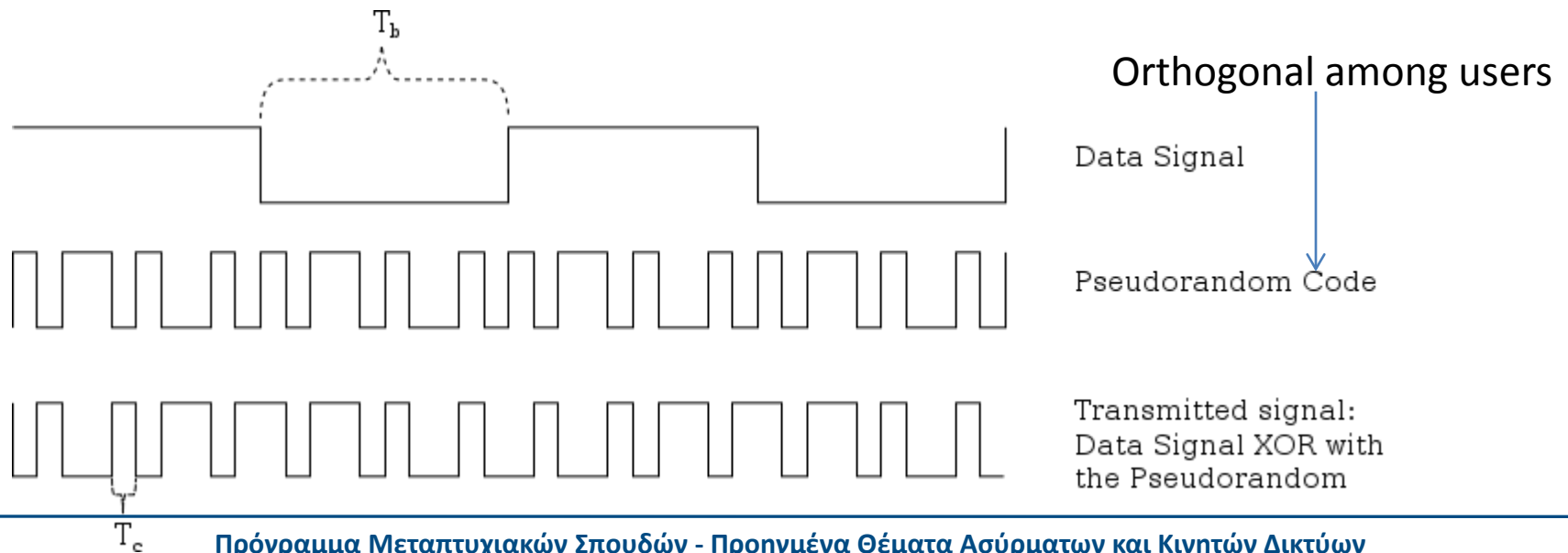



ALOHA

User

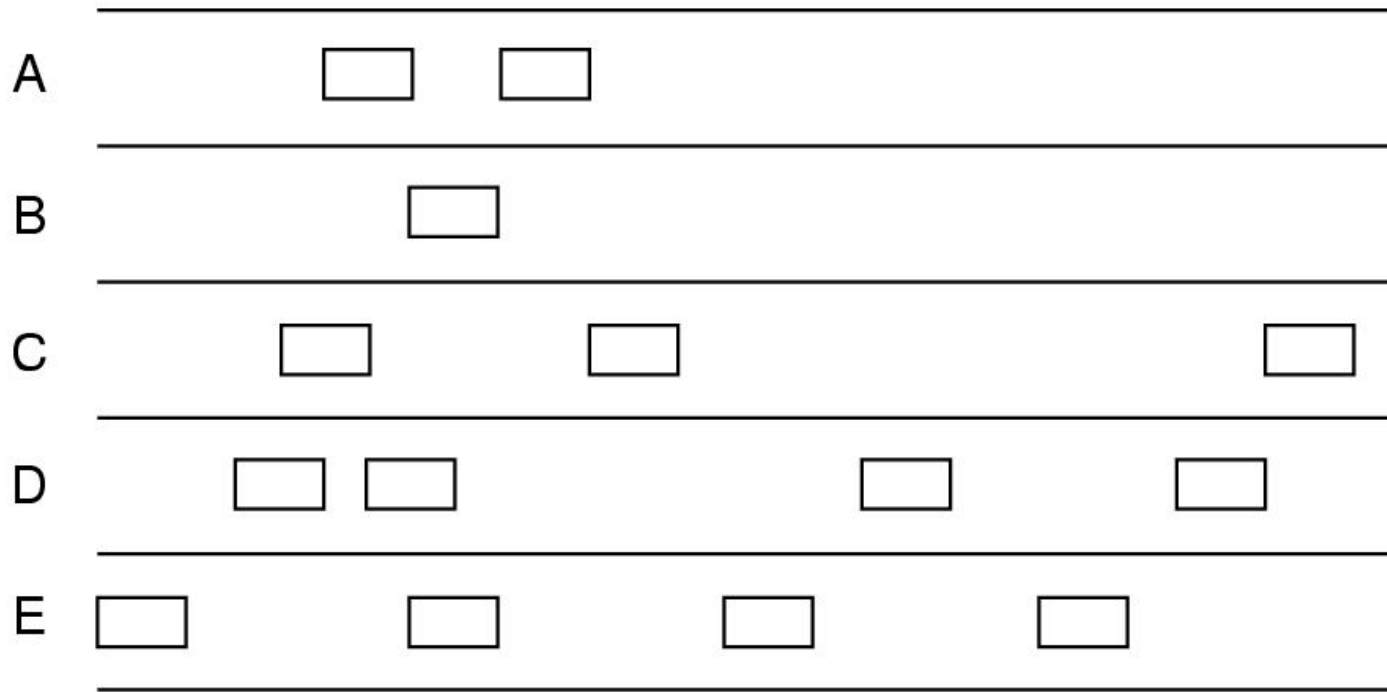

Time →



A comparison of simple protocols

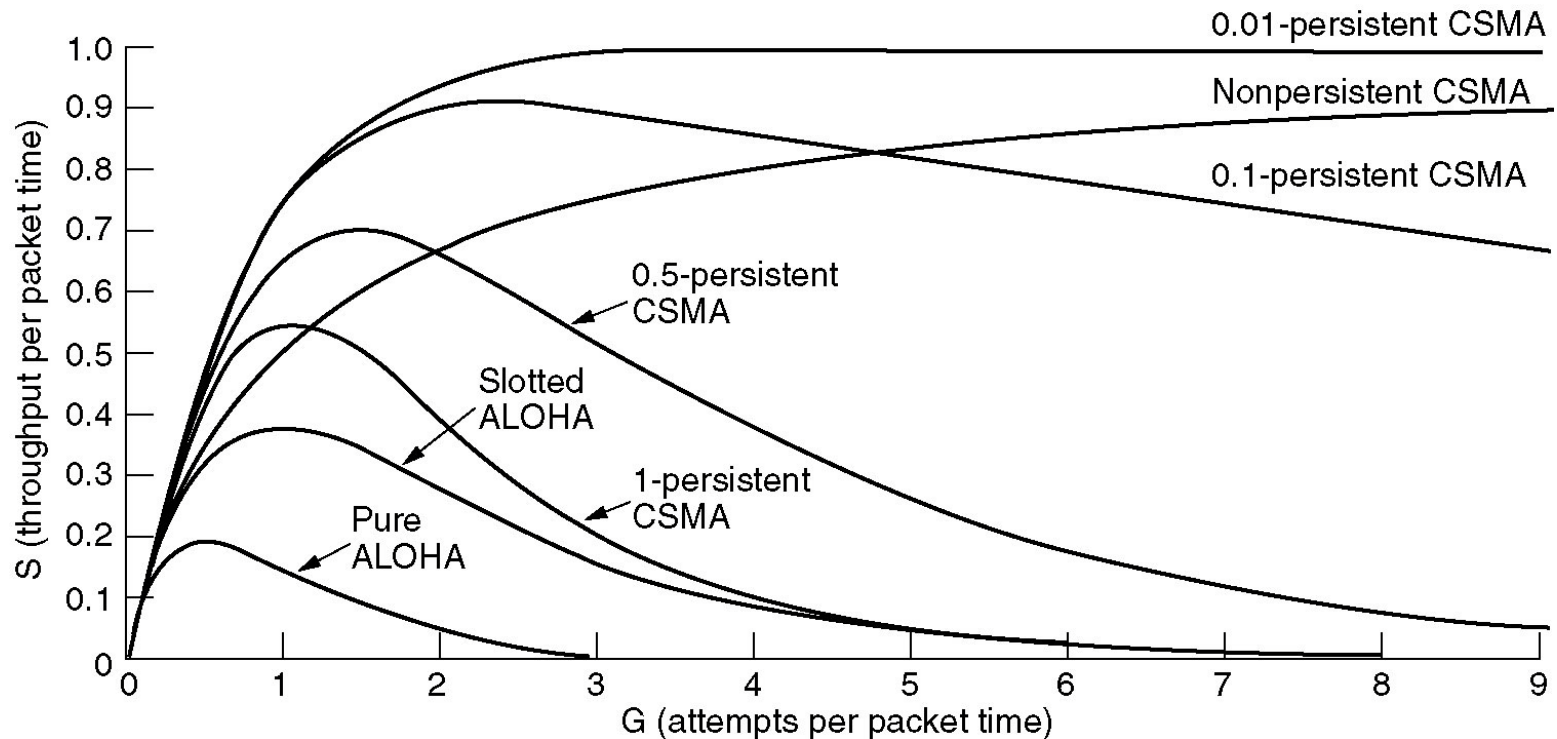



- Based on IEEE 802.11 standard and its amendments (a,b,g,n,...)
- Simple but efficient especially for light/medium traffic
- Cheap to implement and operate
- Constantly upgraded to be up to date
- Follows the evolution in wireless communications



802.X Family of Standards

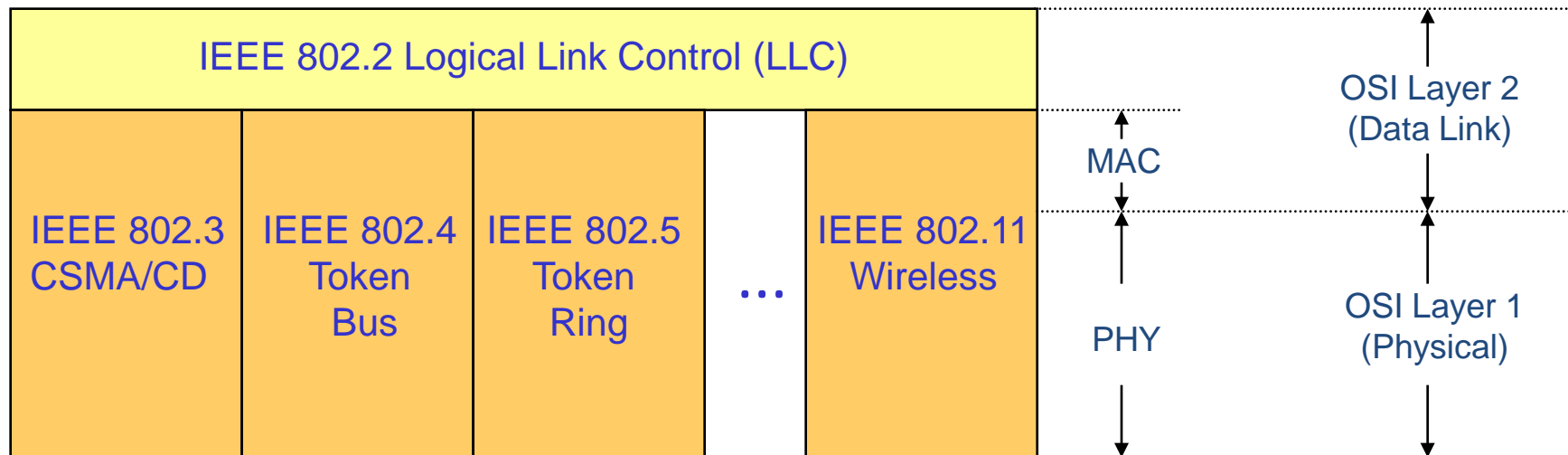



802.11 OSI Protocol Stack

OSI Reference Model

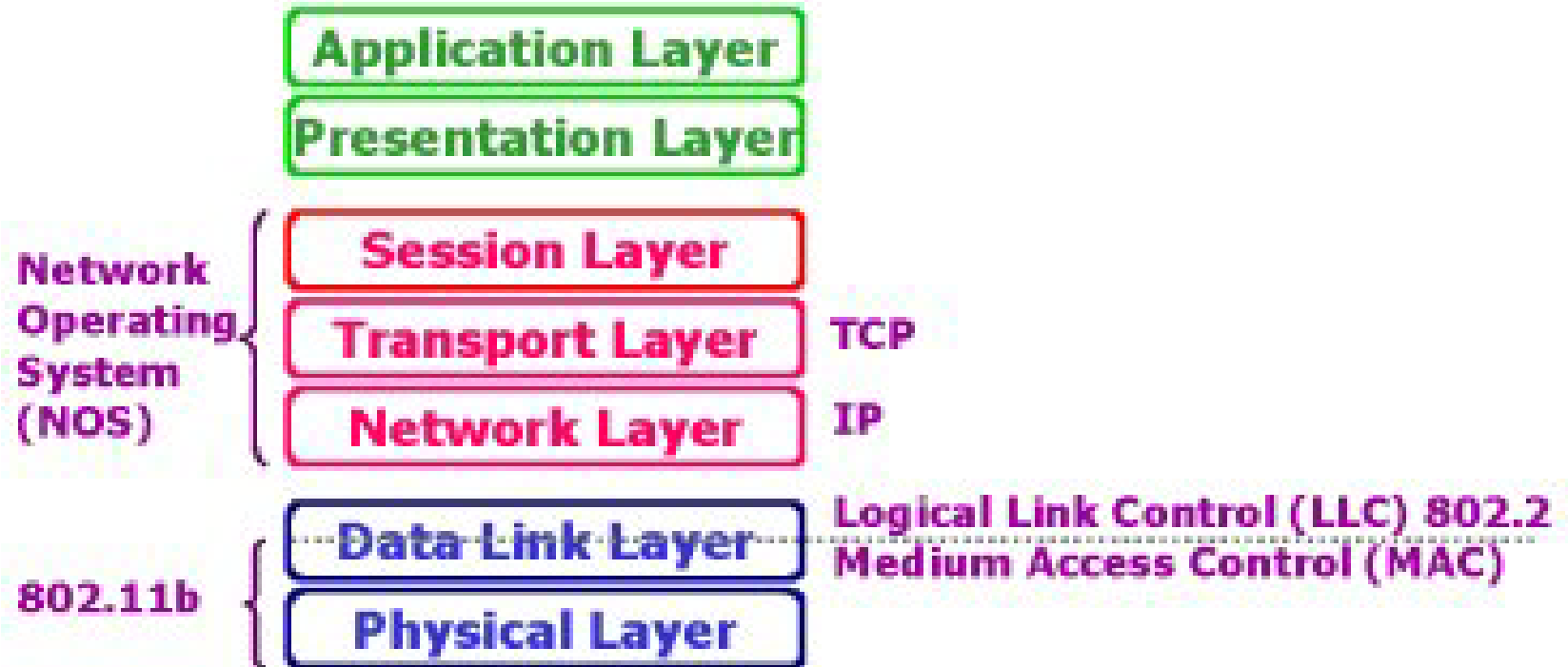



802.11 – Ethernet Wireless Extension

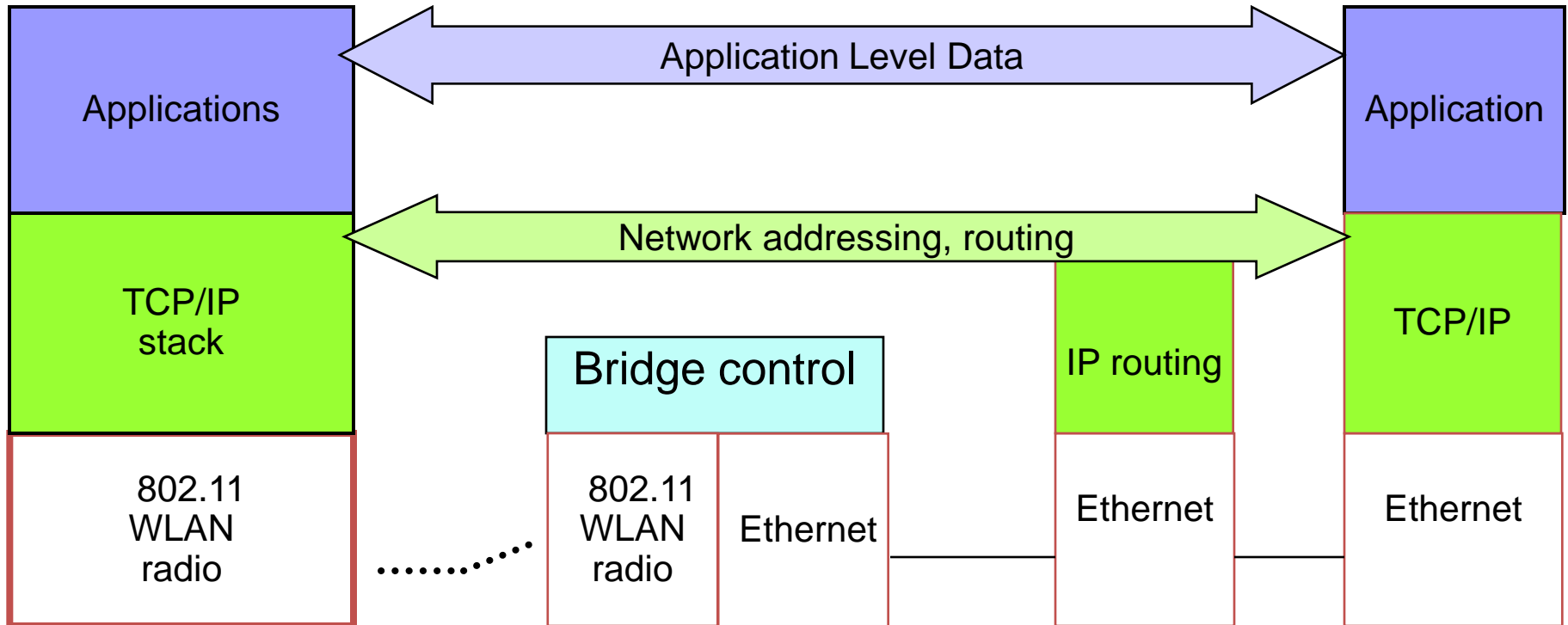

Access Modes

Distributed Coordination Function (DCF)

- Mandatory
- Basic access mode
- Contention-based

Point Coordination Function (PCF)

- Optional
- Contention-free
- Lower delay variance

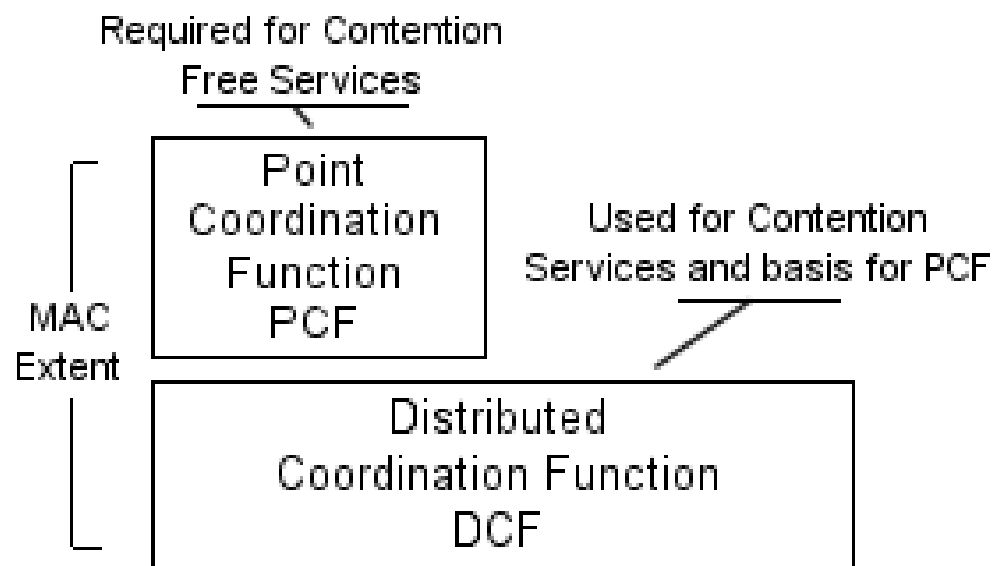



Distributed Coordination Function

- CSMA/CA based protocol
 - Listen before talk
 - Collision Avoidance instead of Collision Detection
 - Different than CSMA/CD used in wired Ethernet (why ??)
- Uses acknowledgment for all transmission
- Data correction through retransmissions
- 4-way handshake (RTS/CTS/Data/Ack) for «Virtual Carrier Sensing»
- Handles hidden terminal problem



Distributed Coordination Function

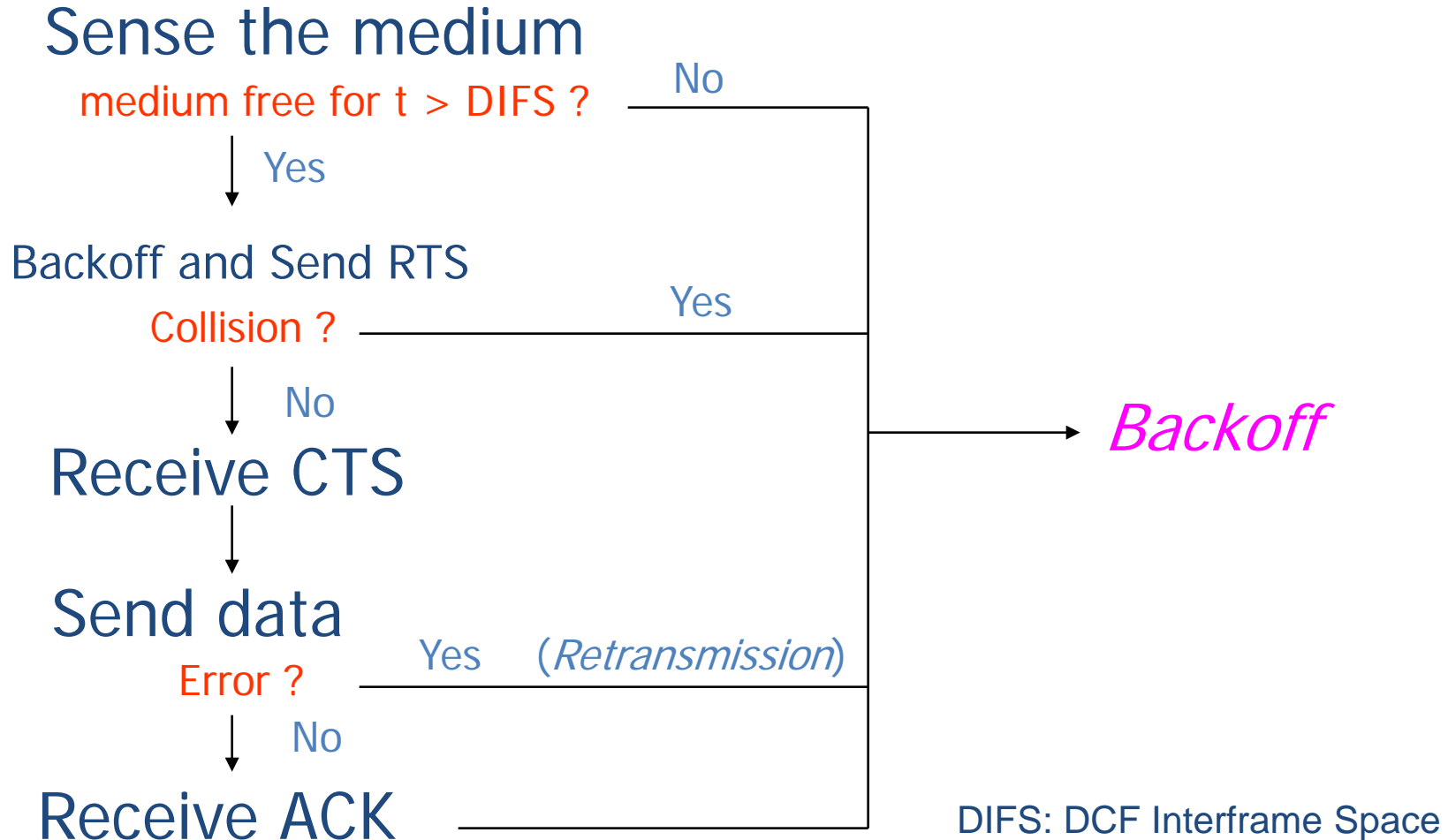

Collision avoidance in node B

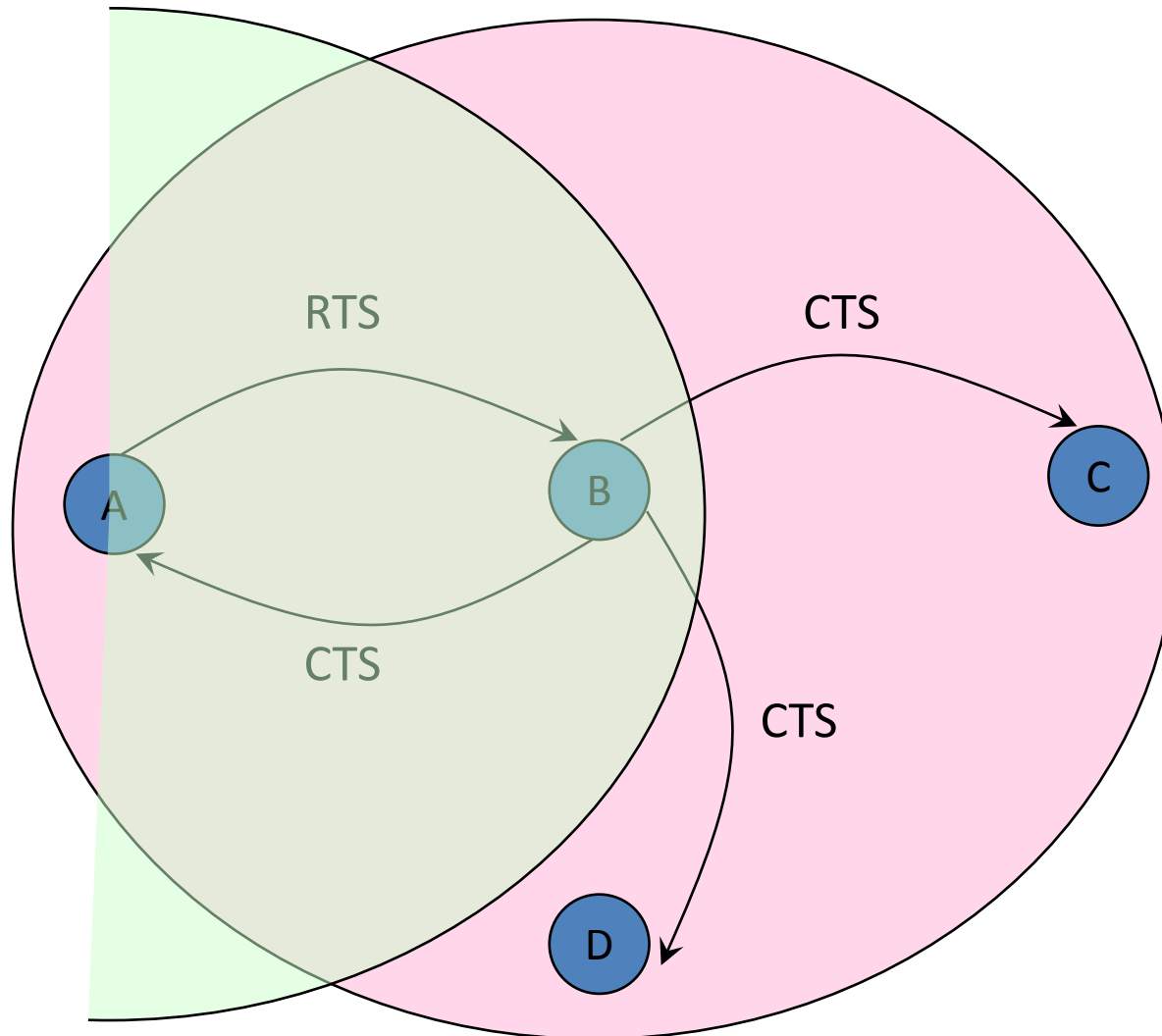

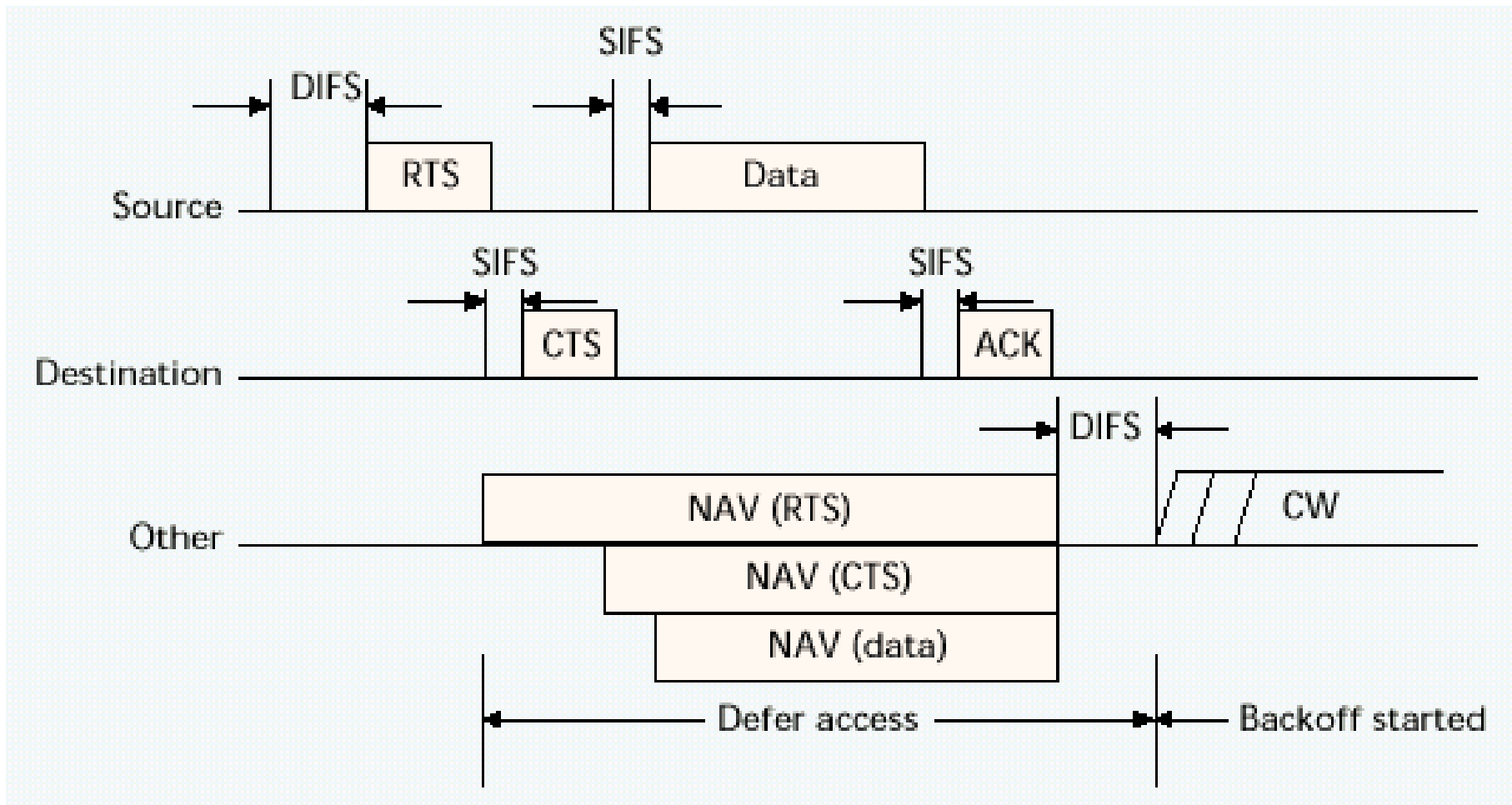

- Always $SIFS < DIFS$
- Power saving through the NAVs



Example of DCF Transmission

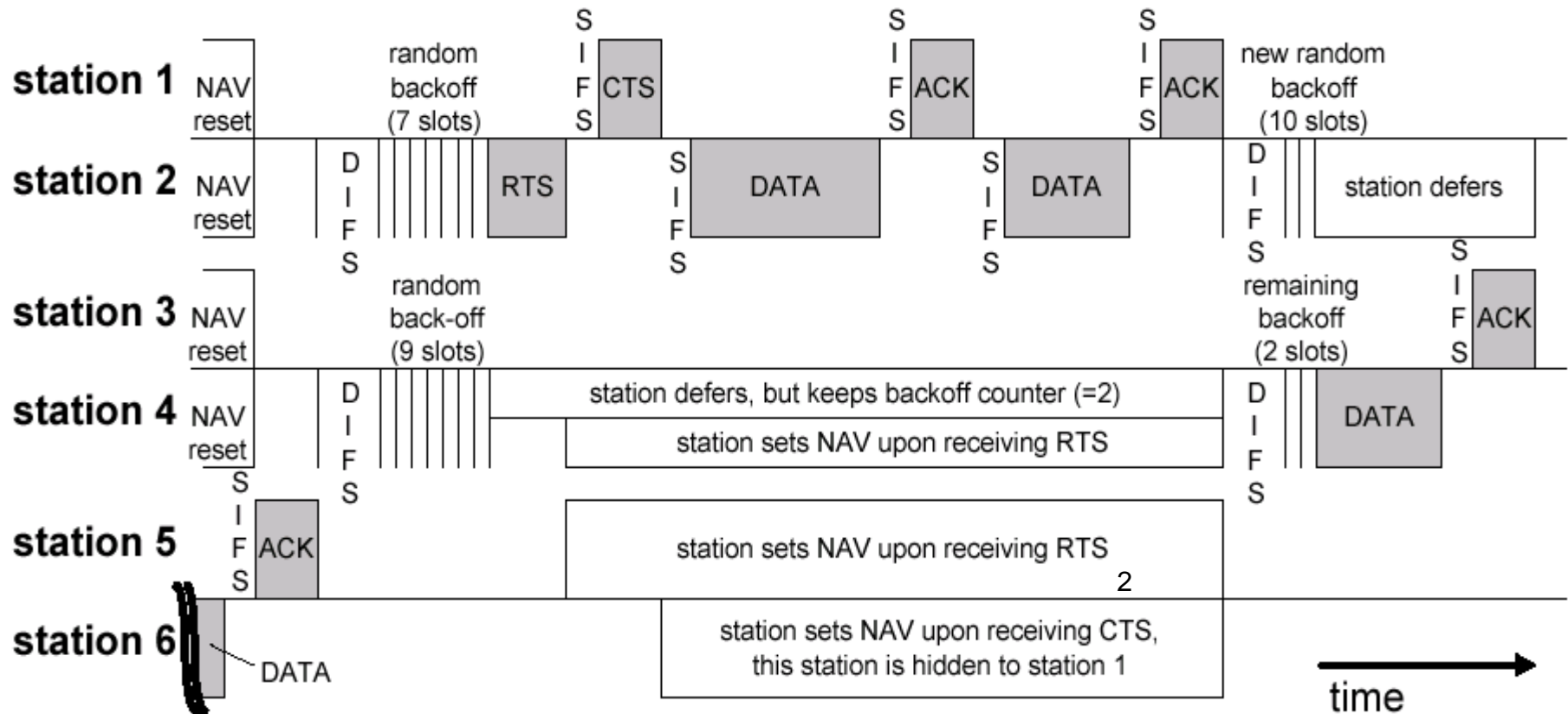



Disadvantages of DCF

- Unpredictable number of **collisions**
- Unpredictable **delays**
- Unpredictable **throughput**
- Equal opportunities for transmission (**no priorities**)

And one advantage

- Low delays and good performance in **light traffic** load conditions



Point Coordination Function

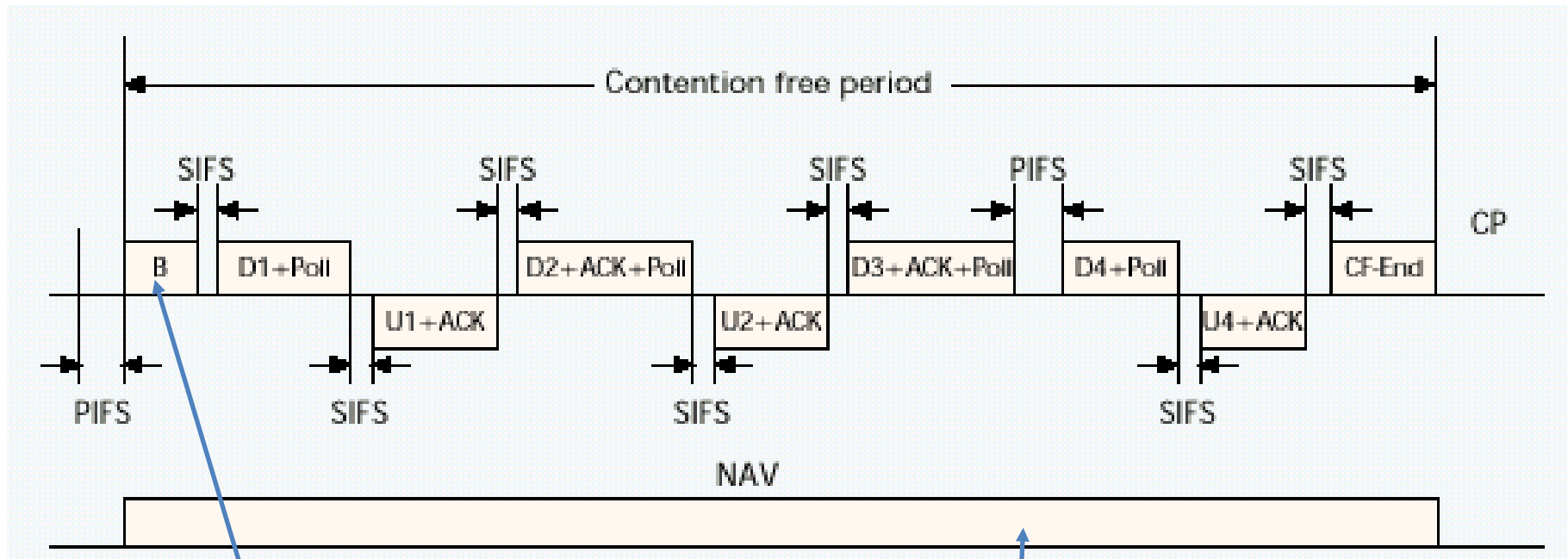

Synchronization beacon

Variable duration of
Contention Free Period



Disadvantages of PCF for QoS

- ✓ Terminals cannot transmit their **requirements** to the AP
- ✓ The AP cannot **stop a transmission** to transmit the synchronization beacon *
- ✓ Polling does not include **time to reserve** the channel *

* Maximum packet (MPDU) allowed 4095 bytes = 32760 bits
= 32,76 msec (για κανάλι 1Mbps)

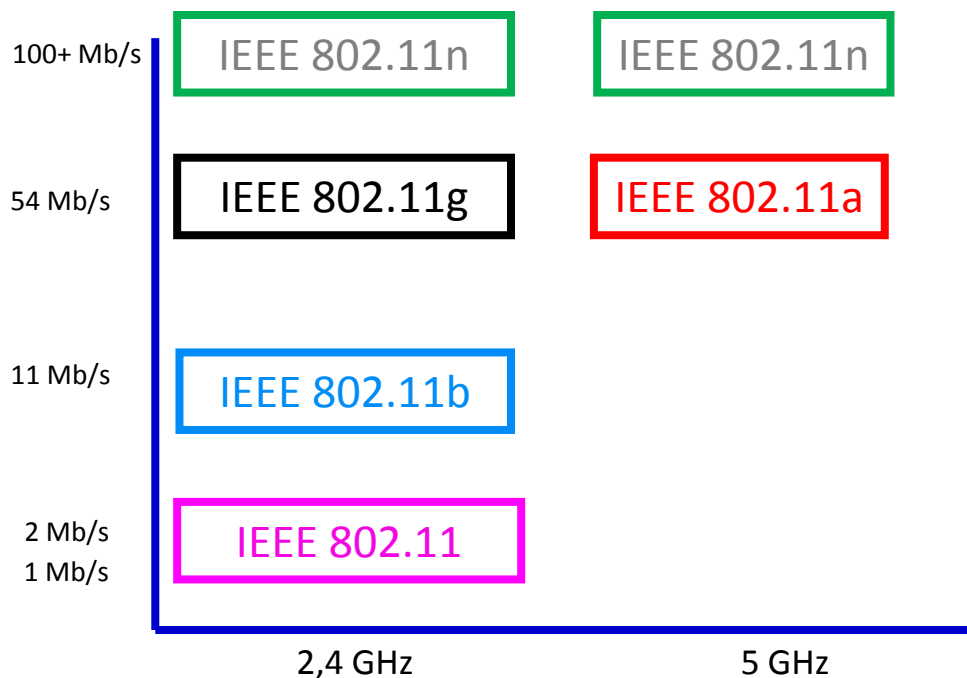

	802.11a	802.11b	802.11g	802.11n
Maximum Data Rate	54 Mbps	11 Mbps	54 Mbps	600 Mbps
Modulation	OFDM	DSSS	OFDM	OFDM
RF Band	5 GHz	2.4 GHz	2.4 GHz	2.4 GHz or 5 GHz
Number of spatial streams (MIMO)	1	1	1	1 to 4
Channel Width	20 MHz	20 MHz	20 MHz	20 MHz or 40 MHz



OFDM: Orthogonal Frequency Division Multiplexing

Traditional FDM

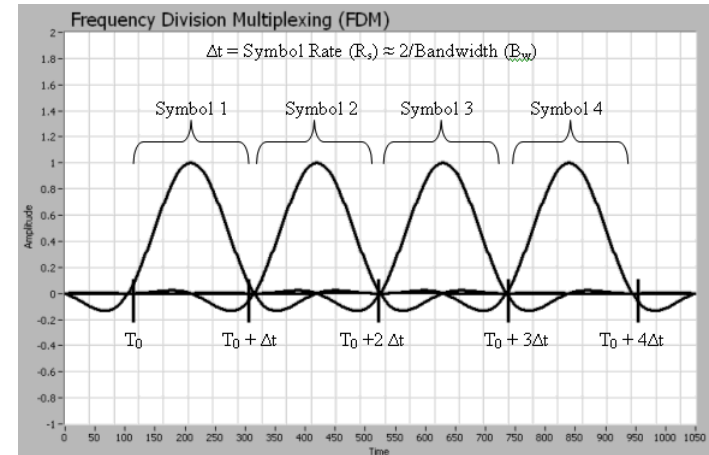
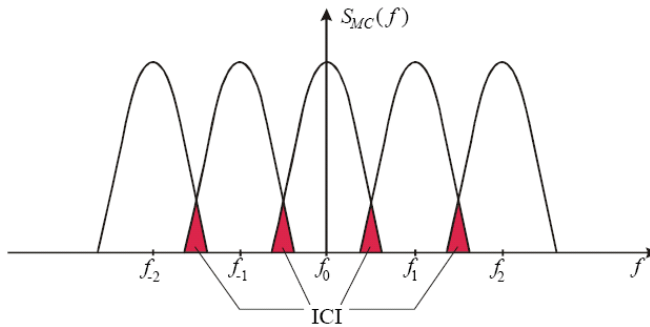

OFDM

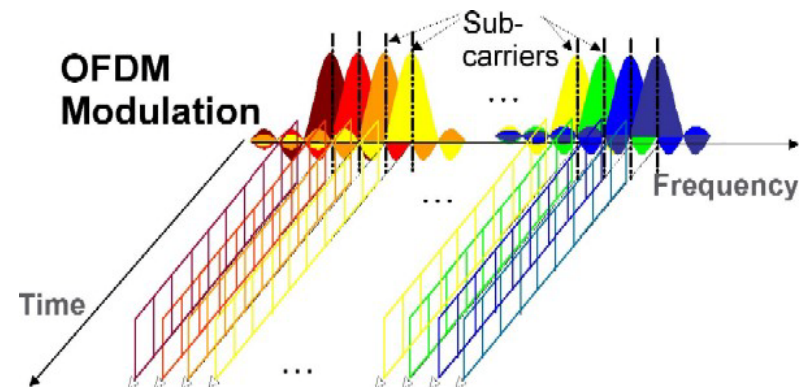
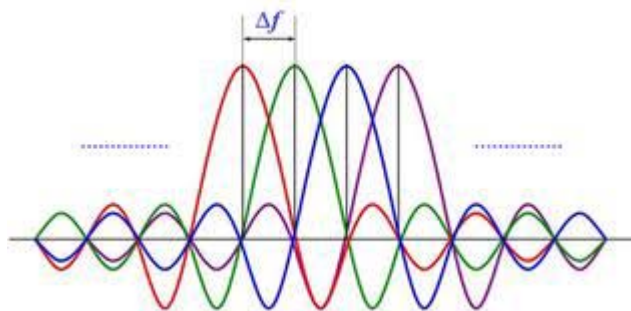

OFDM pros and cons

Pros

- Spectral **efficiency**
- **Robust** against narrow-band co-channel **interference**
- Higher **throughput** in the same frequency band (more subcarriers)

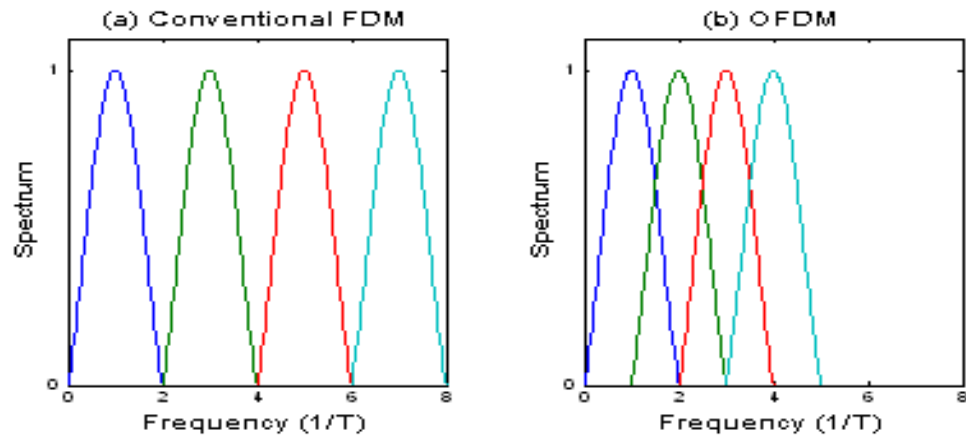

Cons

- It is more sensitive to **carrier frequency offsets**
- More **energy requirements** due to high peak-to-average power ratio (PAPR)



IEEE 802.16 WiMaX

"Air Interface for Fixed Broadband
Wireless Access Systems"



WirelessMAN: Wireless Metropolitan Area Network

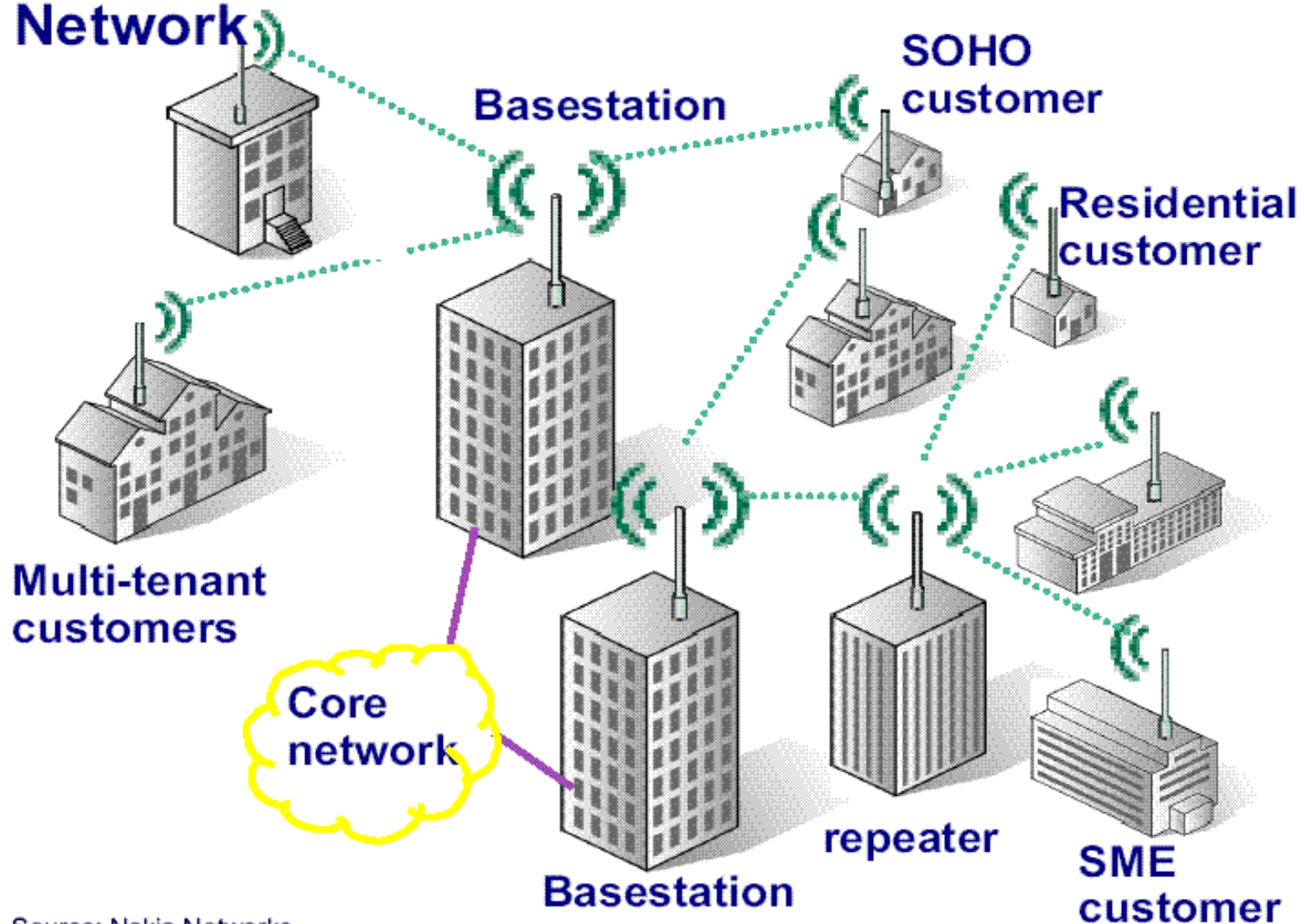

Source: Nokia Networks

WiMaX Layers

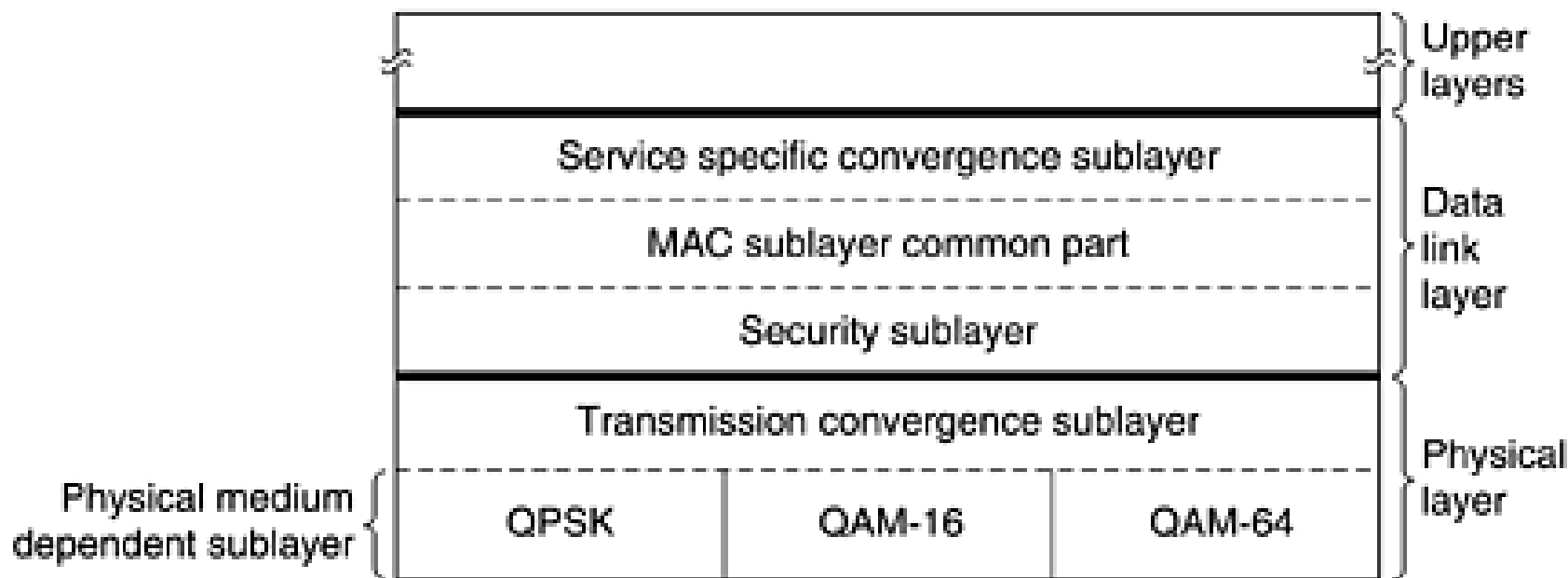



The 802 Family

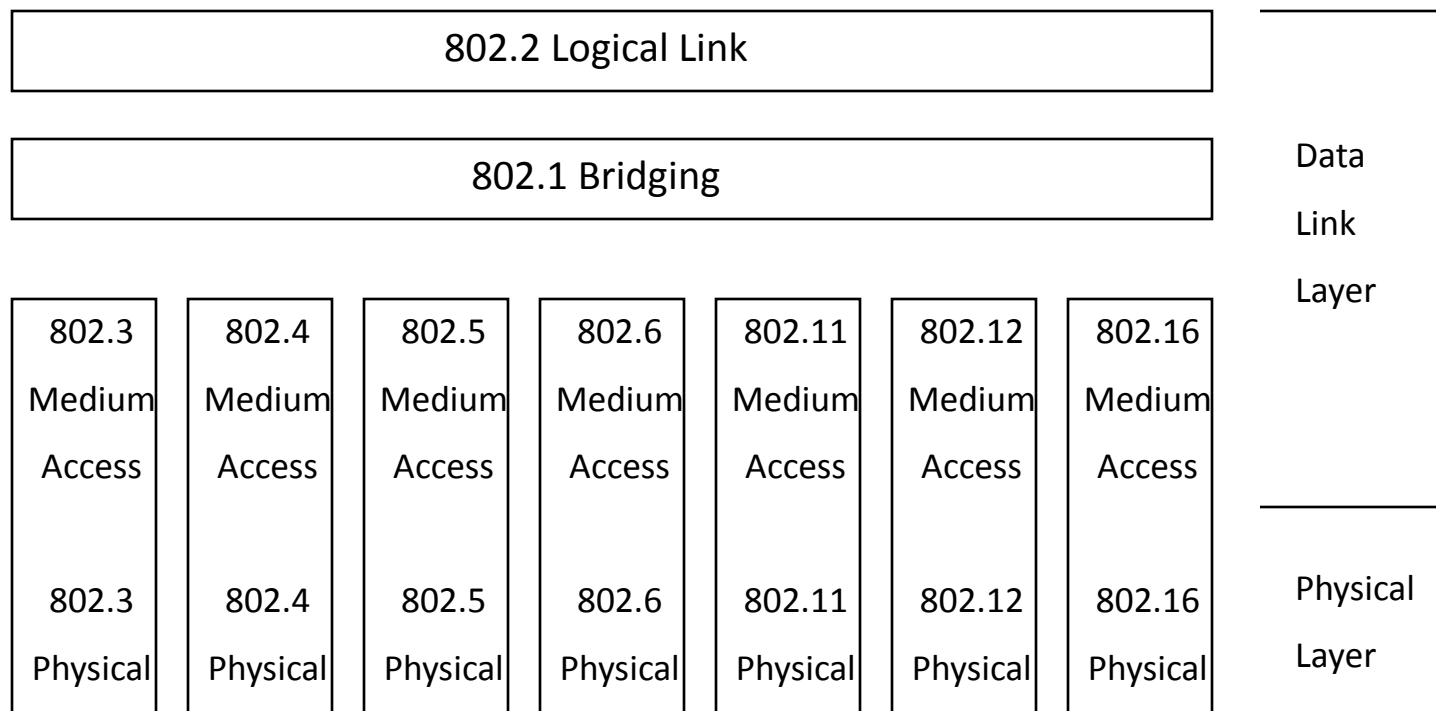



Multiple modulations

- QPSK (Quadrature Phase Shift Keying) = 4 phase shifts, 1 amplitude level, 2 bits/symbol
- QAM-16 = 4 phase shifts, 4 amplitude levels, 4 bits/symbol
- QAM-64 = 4 phase shifts, 16 amplitude levels, 6 bits/symbol

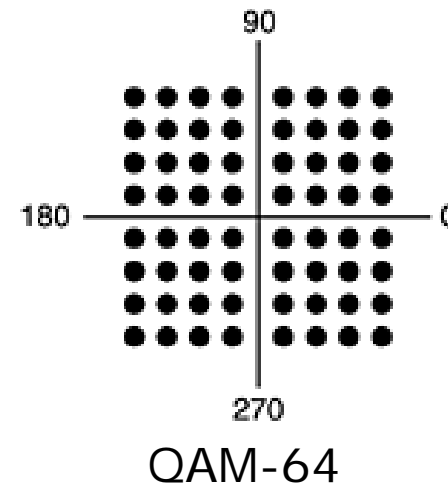
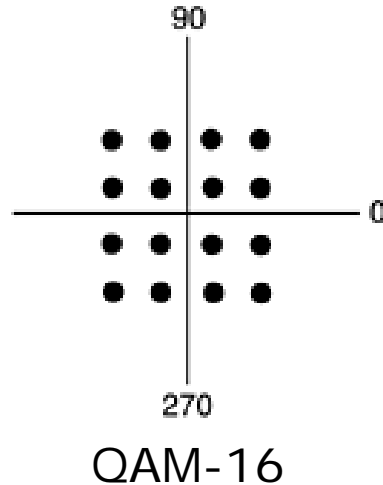
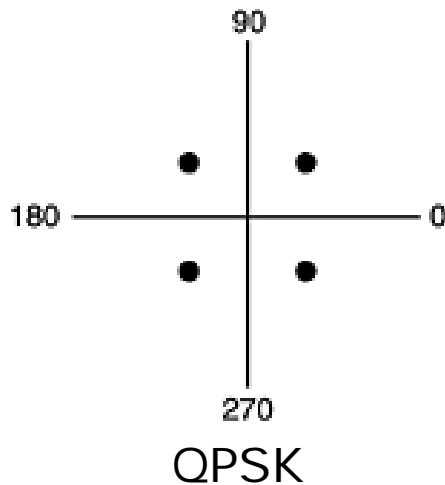

Adaptive modulation

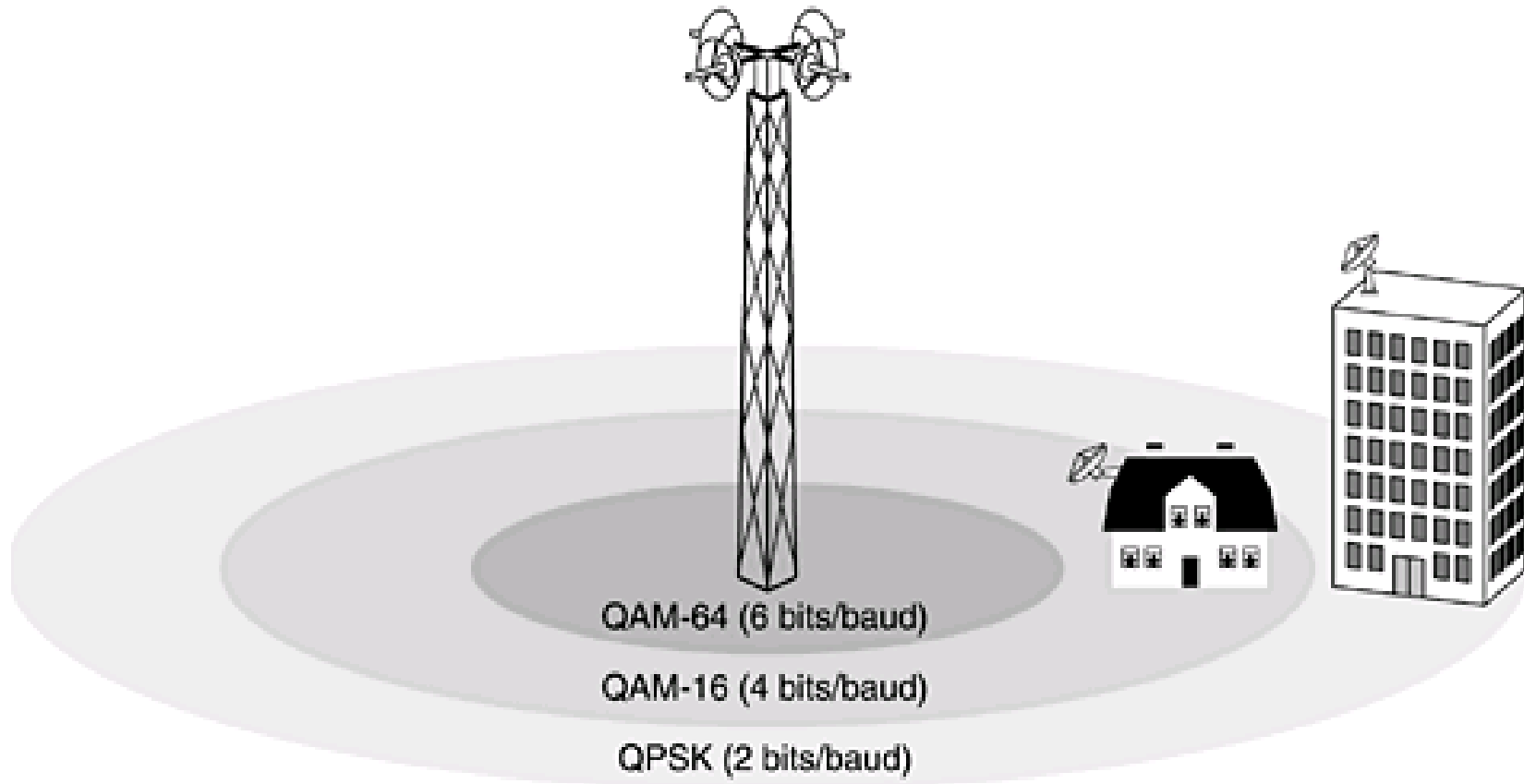



Adaptive modulation in WiMaX

Modulation	FEC Coding Rate	<u>Uncoded</u> Burst Rate (Mbps)	End to End Ethernet Throughput (Mbps)
BPSK	$\frac{1}{2}$	6	5.7
BPSK	$\frac{3}{4}$	9	8.6
QPSK	$\frac{1}{2}$	12	11.4
QPSK	$\frac{3}{4}$	18	17
16QAM	$\frac{1}{2}$	24	22.4
16QAM	$\frac{3}{4}$	36	33
64QAM	$\frac{2}{3}$	48	43.2
64QAM	$\frac{3}{4}$	54	48.1



Time Division Duplexing (TDD)

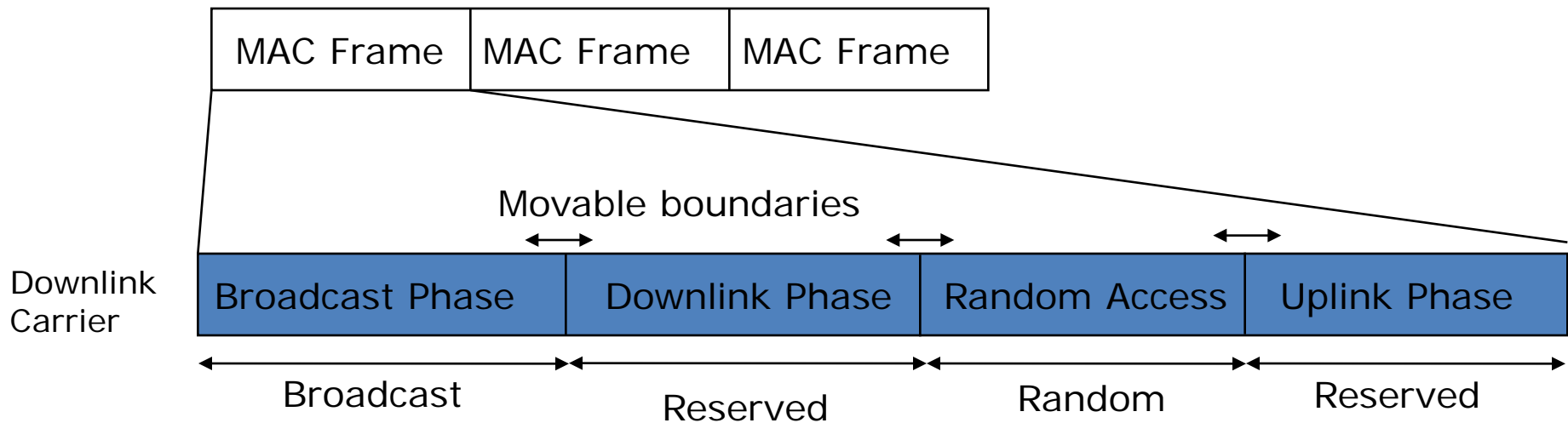



Media Access Control (MAC)

- Connection oriented μετάδοση
 - Connection ID (CID)
 - Uni-directional
- Channel access:
 - UL-MAP
 - Includes reservation information for the uplink
 - Who transmits (to the Base Station) and when
 - DL-MAP
 - Includes reservation information for the downlink
 - Who receives (from the Base Station) and when
 - UL-MAP and DL-MAP are transmitted at the beginning of each time frame (broadcasting).

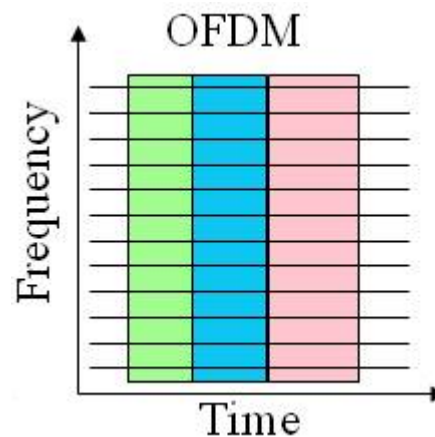
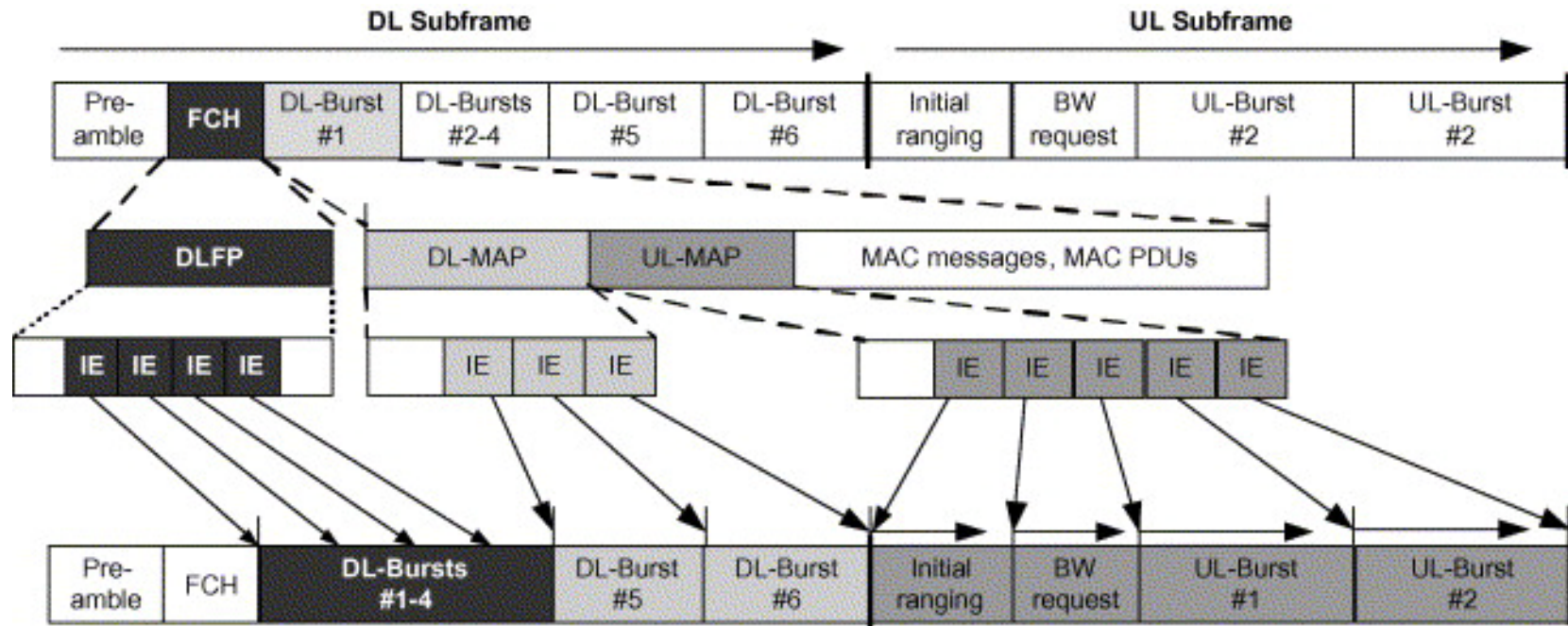



Bandwidth request and allocation

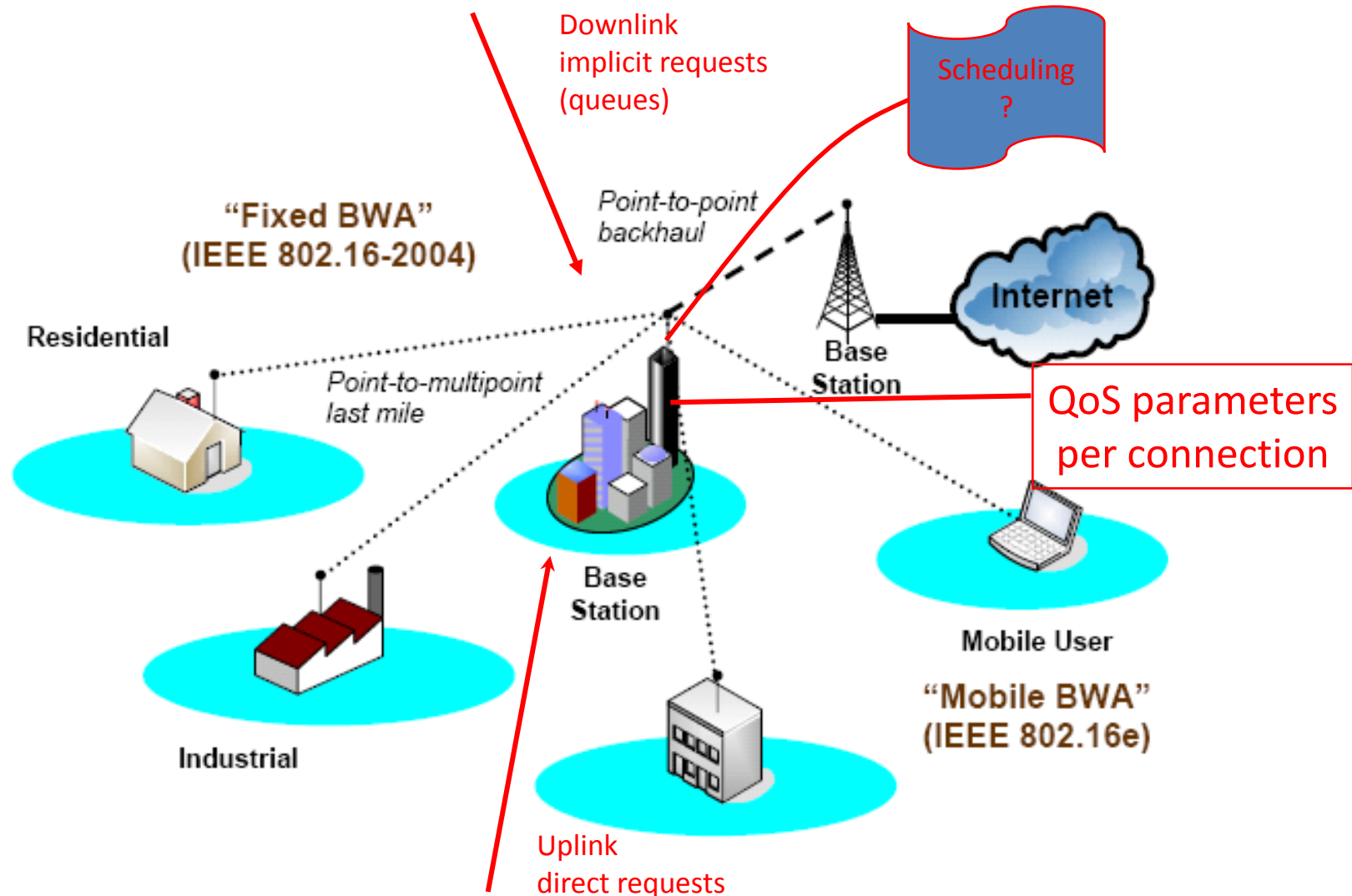



Extensions in 802.16e

- Mobility support
- Orthogonal time division multiple access (OFDMA)



SC/OFDM/OFDMA

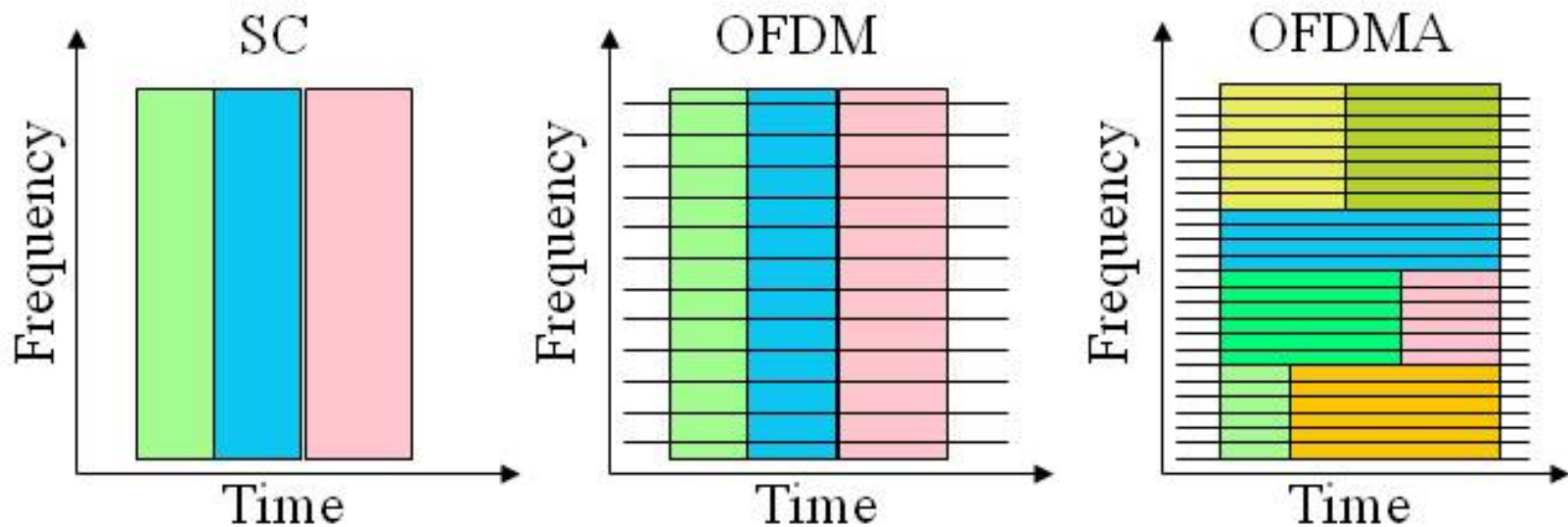



OFDMA/TDD structure

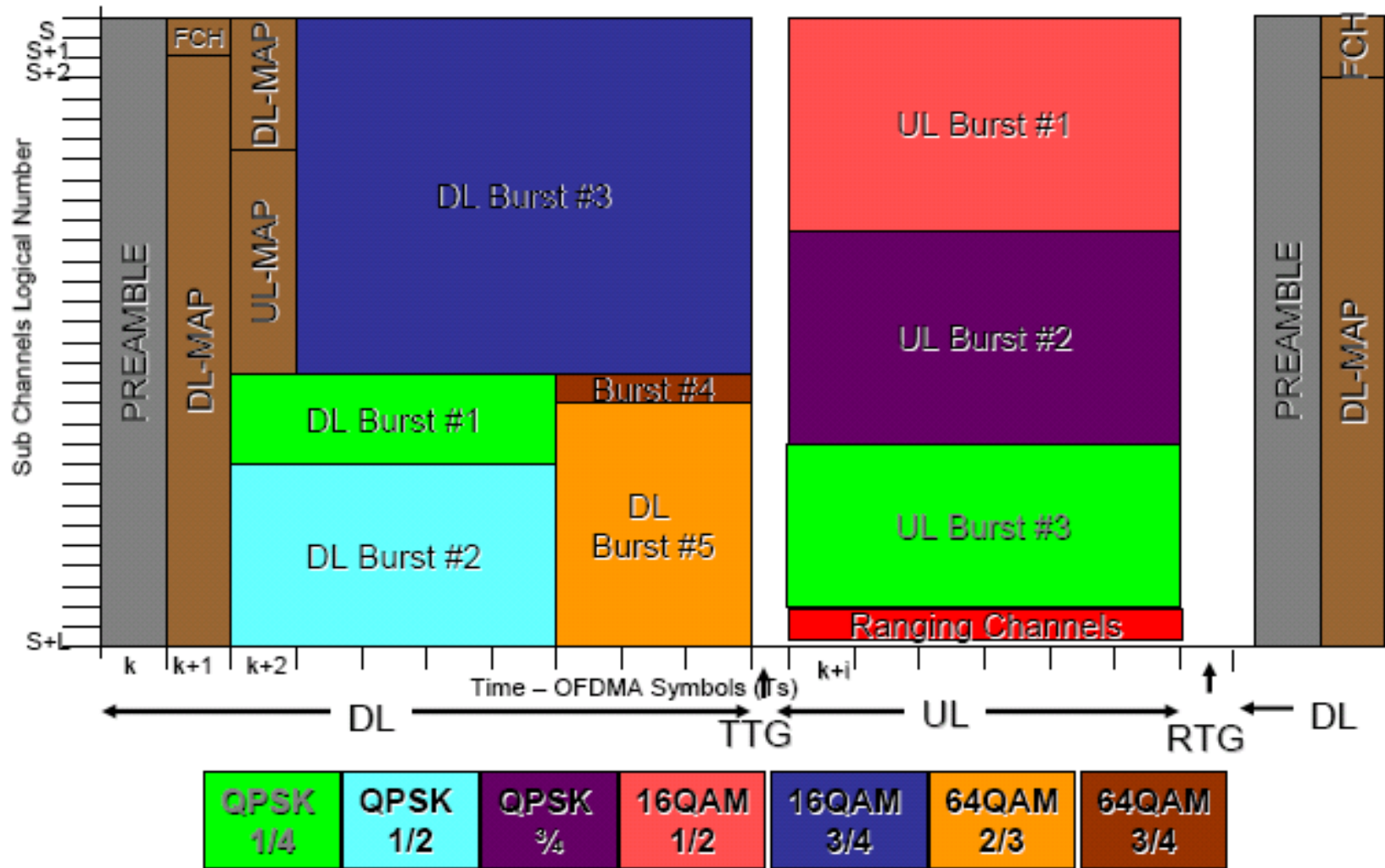



Advantages of OFDMA

- More **flexible allocation** of the available spectrum.
- Avoid transmission in **low quality carriers** (e.g., due to interference).
- **Lower maximum transmission power** for users.
- Higher overall **throughput**.
- Allows **simultaneous transmissions** from several users.
- Lower **delay variance**.
- Averaging interferences from **neighboring cells**, by using different carriers when possible.

Disadvantage

- Considerably **complex** in design and implementation



Thank you for your attention

