

Long Term Evolution – Advanced (LTE-A)

| | WCDMA (UMTS) | HSPA HSDPA / HSUPA | HSPA+ | LTE | LTE ADVANCED (IMT ADVANCED) |
|-----------------------------------|-----------------|------------------------------|-------------|---------------|-----------------------------------|
| Max downlink speed (bps) | 384k | 14 M | 28 M | 100 M | 1 G |
| Max uplink speed (bps) | 128 k | 5.7 M | 11 M | 50 M | 500 M |
| Latency round trip time (approx.) | 150 ms | 100 ms | 50 ms (max) | ~10 ms | Less than 5 ms |
| 3GPP releases | Rel 99/4 | Rel 5/6 | Rel 7 | Rel 8/9 | Rel 10 |
| Approx years of initial roll out | 2003/4 | 2005/6 HSDPA 2007/8 HSUPA | 2008/9 | 2009/10 | |
| Access methodology | CDMA | CDMA | CDMA | OFDMA/SC-FDMA | OFDMA/SC-FDMA |

LTE-A main features

Support of Wider Bandwidth(Carrier Aggregation)

- Use of multiple component carriers(CC) to **extend bandwidth up to 100 MHz**
- Common physical layer parameters between component carrier and LTE Rel-8 carrier
- ➔ **Improvement of peak data rate, backward compatibility with LTE Rel-8**

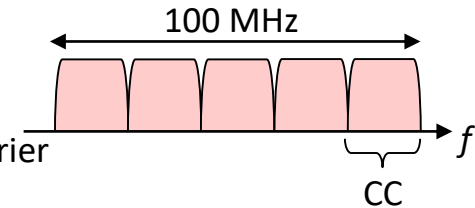

Advanced MIMO techniques

- Extension to up to **8-layer transmission in downlink**
- Introduction of single-user MIMO up to **4-layer transmission in uplink**
- Enhancements of multi-user MIMO
- ➔ **Improvement of peak data rate and capacity**

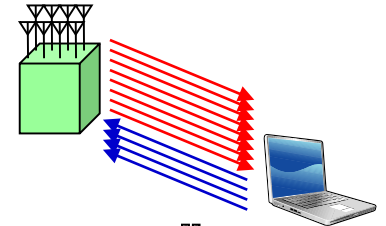

Heterogeneous network and eICIC (enhanced Inter-Cell Interference Coordination)

- **Interference coordination** for overlaid deployment of cells with different Tx power
- ➔ **Improvement of cell-edge throughput and coverage**

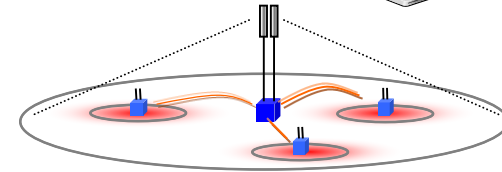

Relay

- Supports radio backhaul and **creates a separate cell** and appear as Rel. 8 LTE eNB to Rel. 8 LTE UEs
- ➔ **Improvement of coverage and flexibility of service area extension**

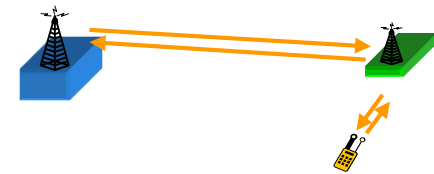

Coordinated Multi-Point transmission and reception (CoMP)

- Support of **multi-cell transmission and reception**
- ➔ **Improvement of cell-edge throughput and coverage**

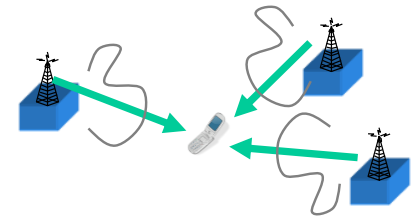

Backward compatibility

LTE-Advanced backward compatibility with LTE Rel-8

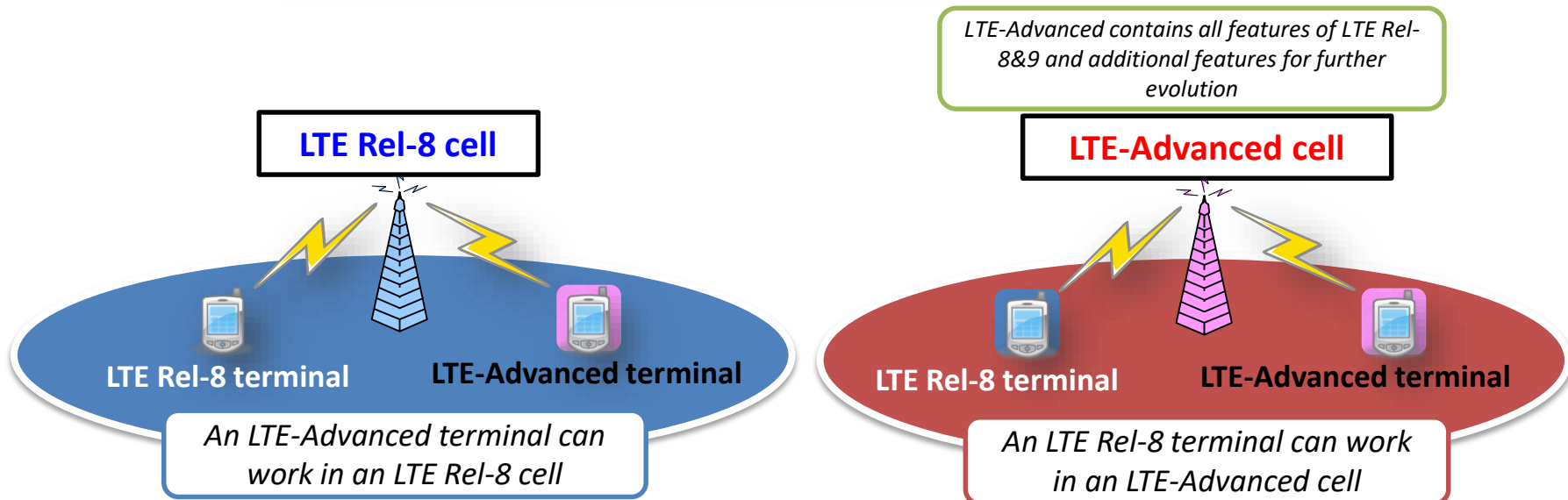

LTE-A main features

Support of Wider Bandwidth(Carrier Aggregation)

- Use of multiple component carriers(CC) to **extend bandwidth up to 100 MHz**
- Common physical layer parameters between component carrier and LTE Rel-8 carrier
- ➔ **Improvement of peak data rate, backward compatibility with LTE Rel-8**

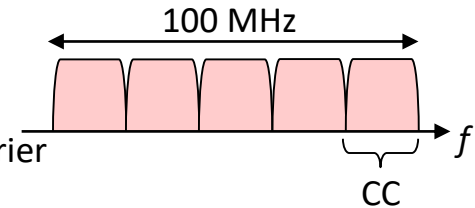

Advanced MIMO techniques

- Extension to up to 8-layer transmission in downlink
- Introduction of single-user MIMO up to 4-layer transmission in uplink
- Enhancements of multi-user MIMO
- ➔ Improvement of peak data rate and capacity

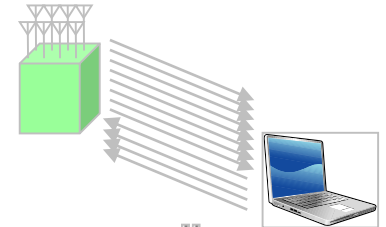

Heterogeneous network and eICIC (enhanced Inter-Cell Interference Coordination)

- Interference coordination for overlaid deployment of cells with different Tx power
- ➔ Improvement of cell-edge throughput and coverage

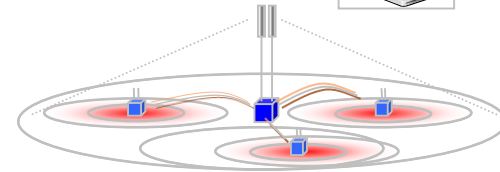

Relay

- Supports radio backhaul and creates a separate cell and appear as Rel. 8 LTE eNB to Rel. 8 LTE UEs
- ➔ Improvement of coverage and flexibility of service area extension



Coordinated Multi-Point transmission and reception (CoMP)

- Support of multi-cell transmission and reception
- ➔ Improvement of cell-edge throughput and coverage

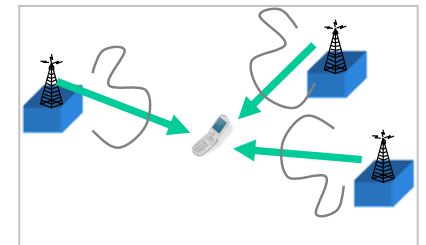

Carrier aggregation

- Extends the maximum transmission bandwidth, **up to 100MHz**, by aggregating up to five LTE carriers – also known as component carriers (CCs)
- Lack of sufficient contiguous spectrum forces use of carrier aggregation to meet peak data rate targets:
 - 1 Gbps in the downlink and 500 Mbps in the uplink
- Motivation:
 - Achieve **wide bandwidth transmissions**
 - Facilitate efficient use of **fragmented spectrum**
 - Efficient **interference management** for control channels in heterogeneous networks

Carrier aggregation

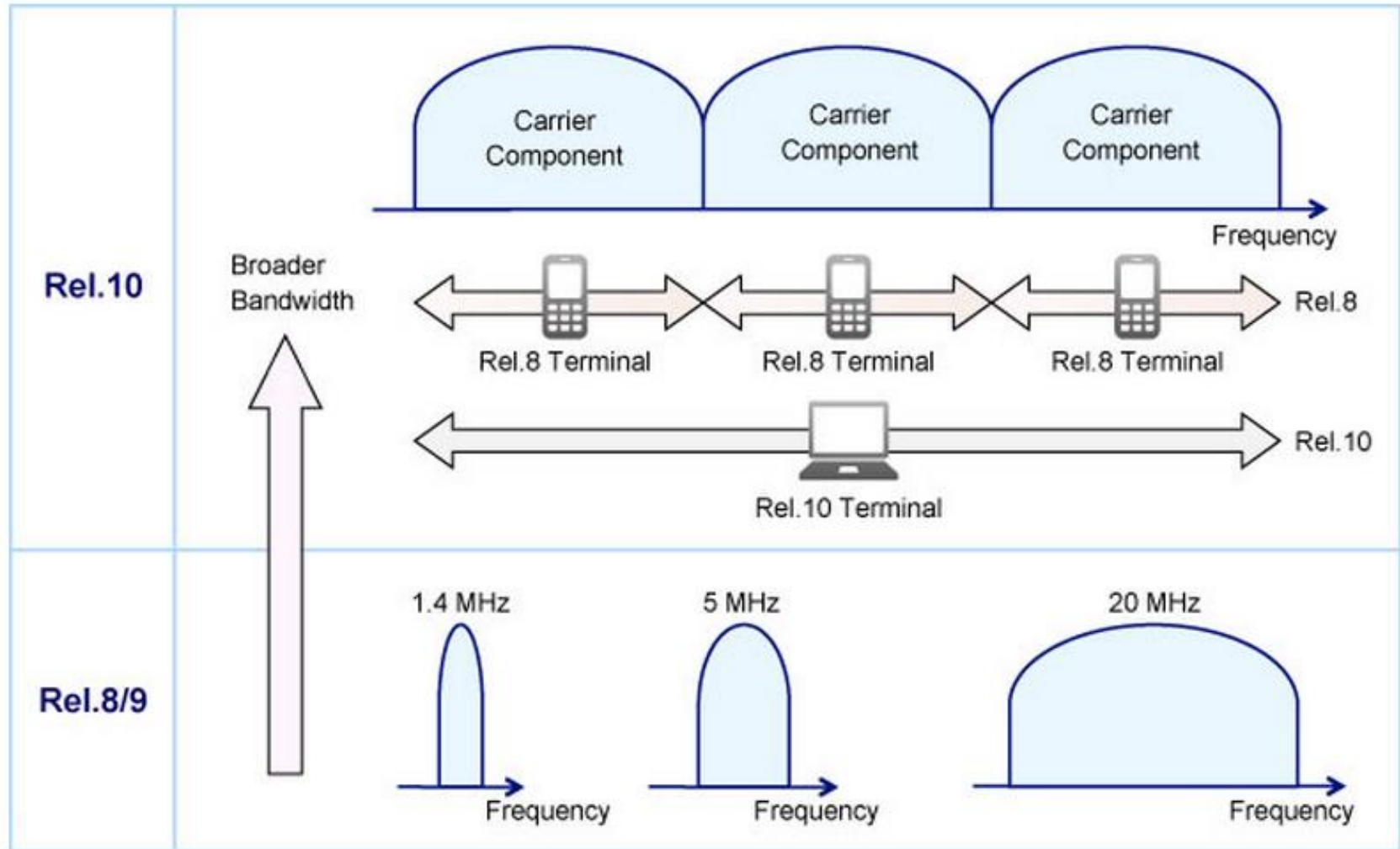

Carrier aggregation modes

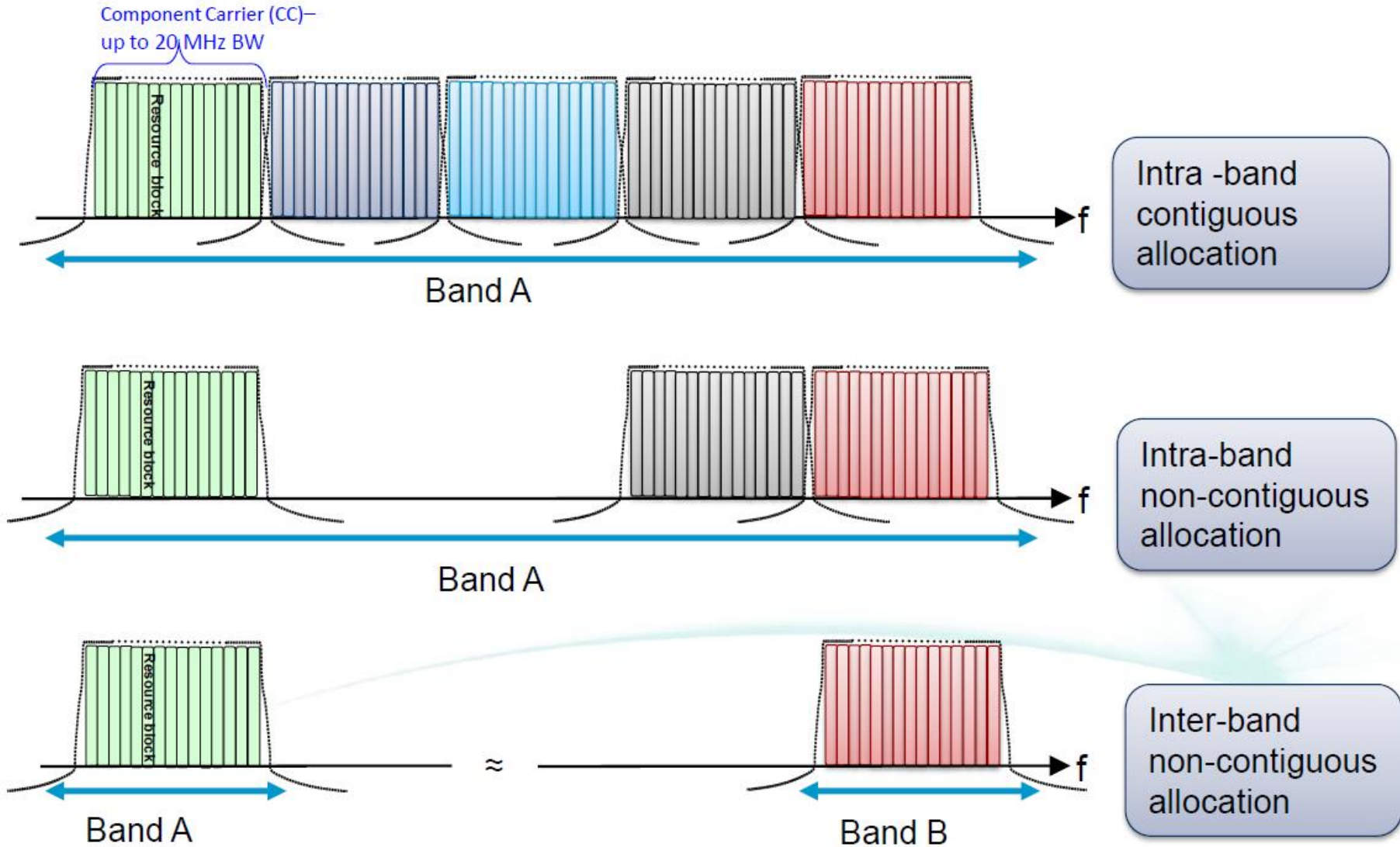

OFDMA/TDD structure

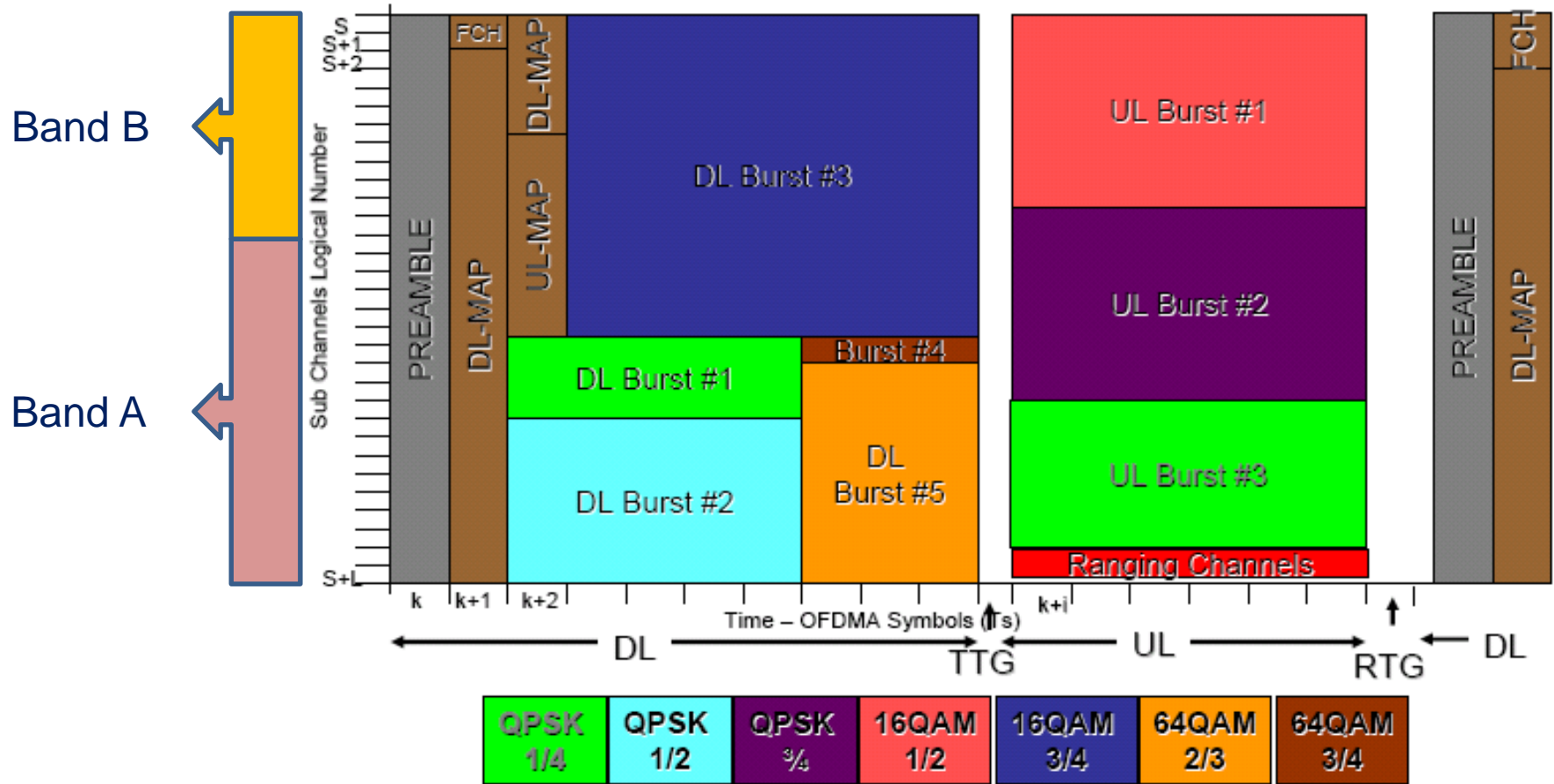

LTE-A main features

Support of Wider Bandwidth(Carrier Aggregation)

- Use of multiple component carriers(CC) to extend bandwidth up to 100 MHz
- Common physical layer parameters between component carrier and LTE Rel-8 carrier
- ➔ Improvement of peak data rate, backward compatibility with LTE Rel-8

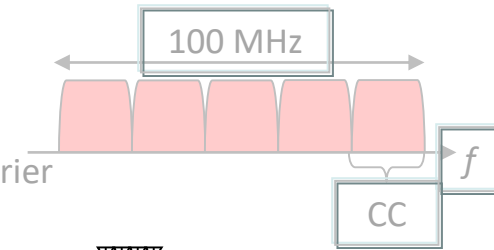

Advanced MIMO techniques

- Extension to up to **8-layer transmission in downlink**
- Introduction of single-user MIMO up to **4-layer transmission in uplink**
- Enhancements of multi-user MIMO
- ➔ Improvement of **peak data rate and capacity**

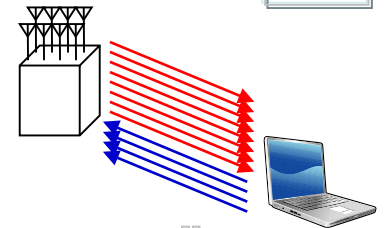

Heterogeneous network and eICIC (enhanced Inter-Cell Interference Coordination)

- Interference coordination for overlaid deployment of cells with different Tx power
- ➔ Improvement of cell-edge throughput and coverage

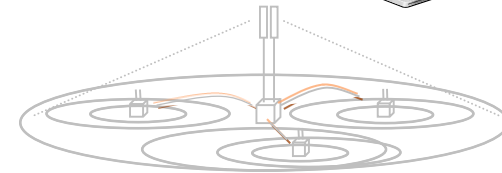

Relay

- Supports radio backhaul and creates a separate cell and appear as Rel. 8 LTE eNB to Rel. 8 LTE UEs
- ➔ Improvement of coverage and flexibility of service area extension



Coordinated Multi-Point transmission and reception (CoMP)

- Support of multi-cell transmission and reception
- ➔ Improvement of cell-edge throughput and coverage

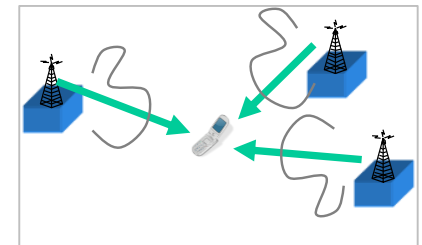

MIMO capabilities

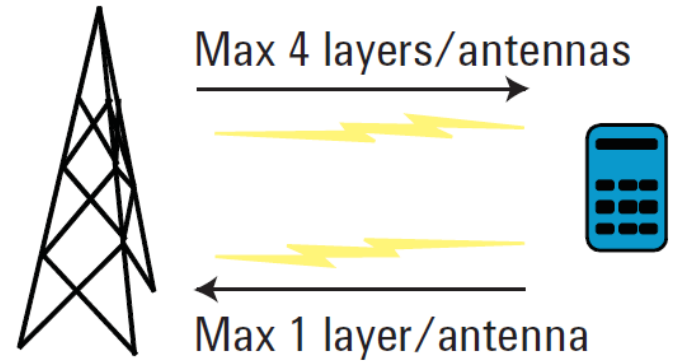
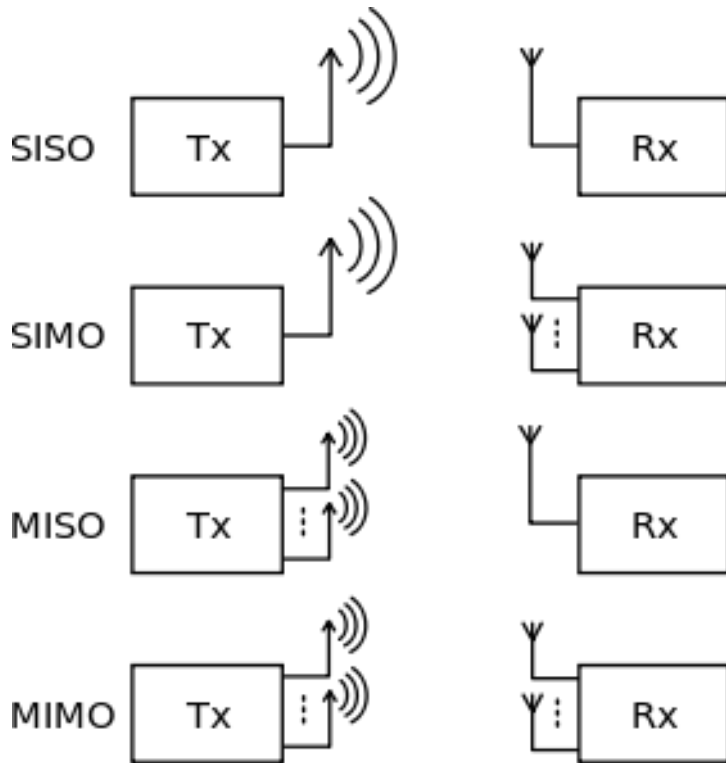

LTE

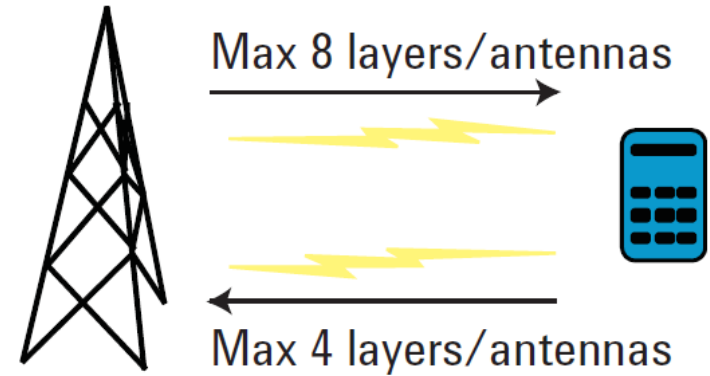

LTE-A

SISO Single Input Single Output

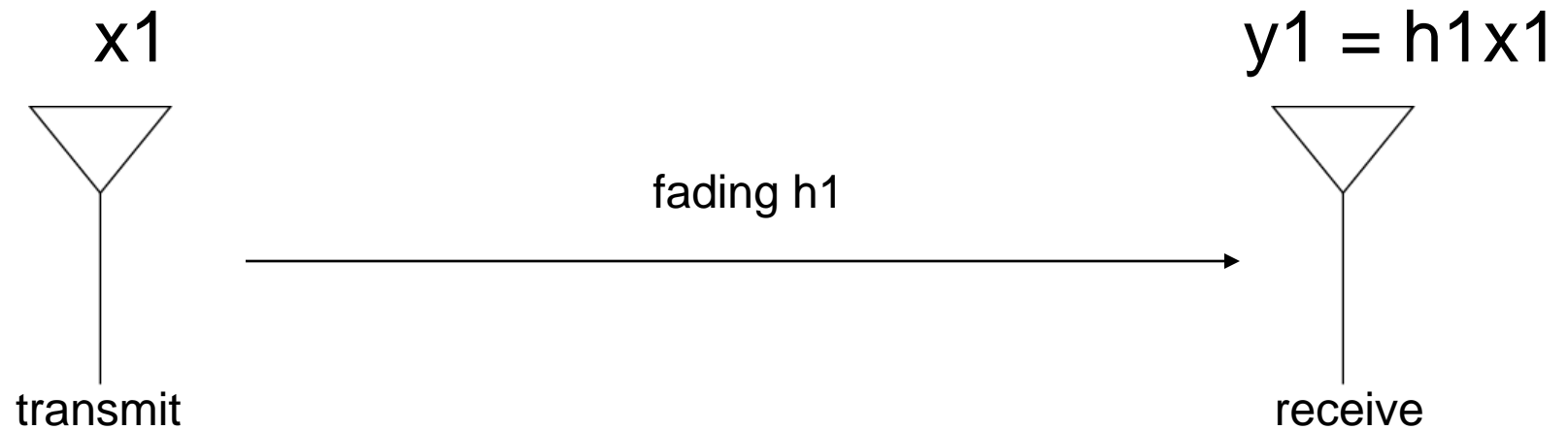

SIMO Single Input Multiple Output

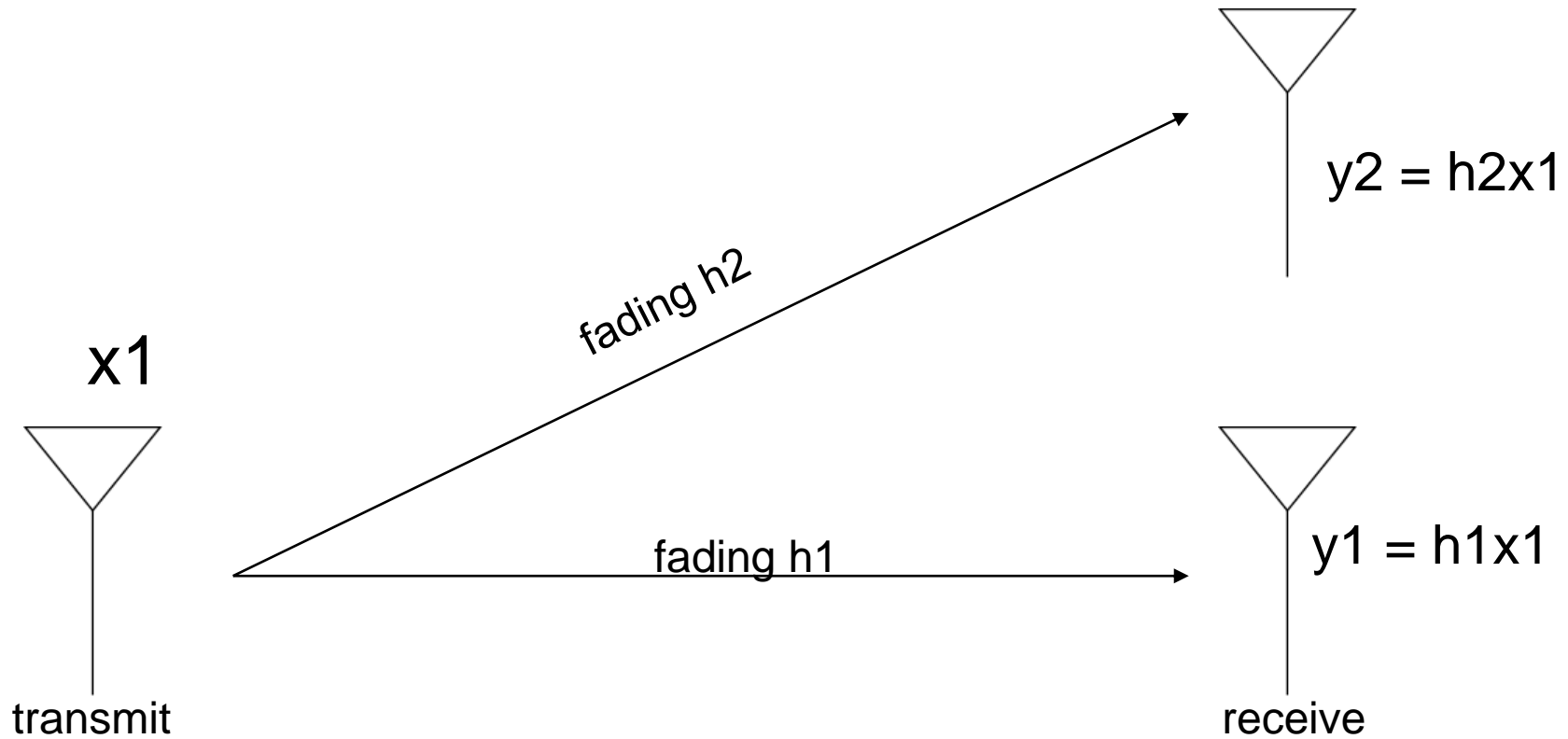

Mitigating fading with receiver diversity

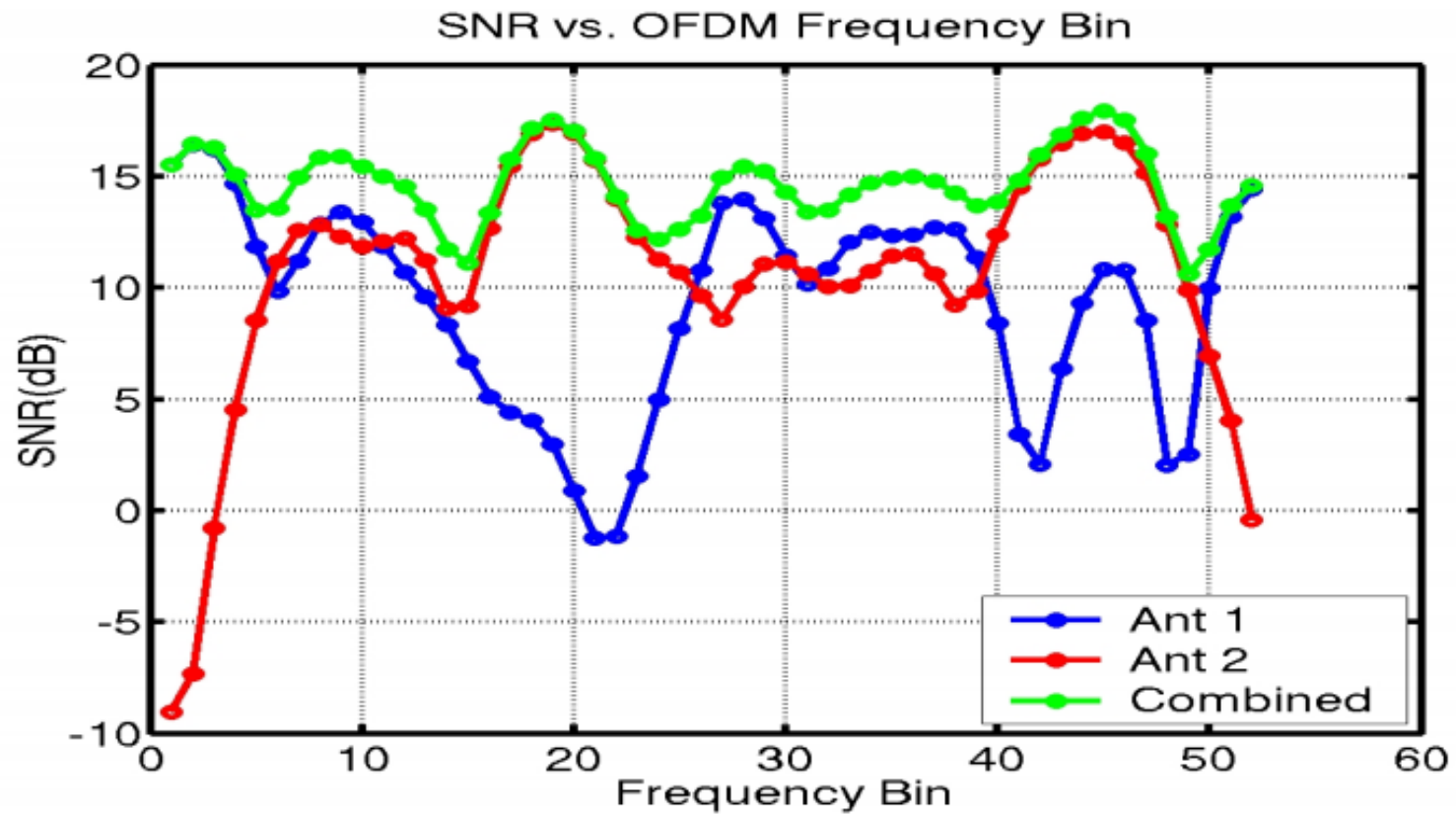

MISO Multiple Input Single Output

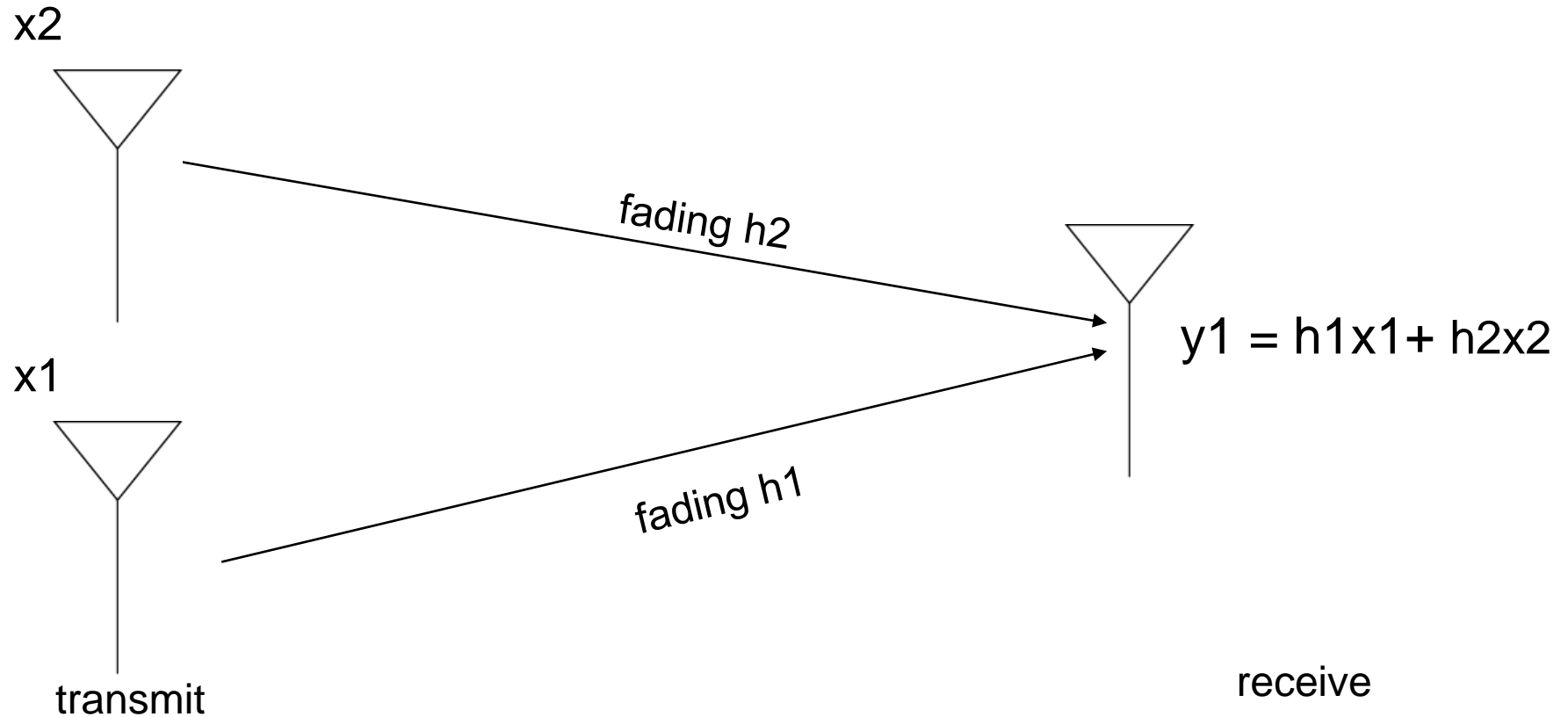

MIMO Multiple Input Multiple Output

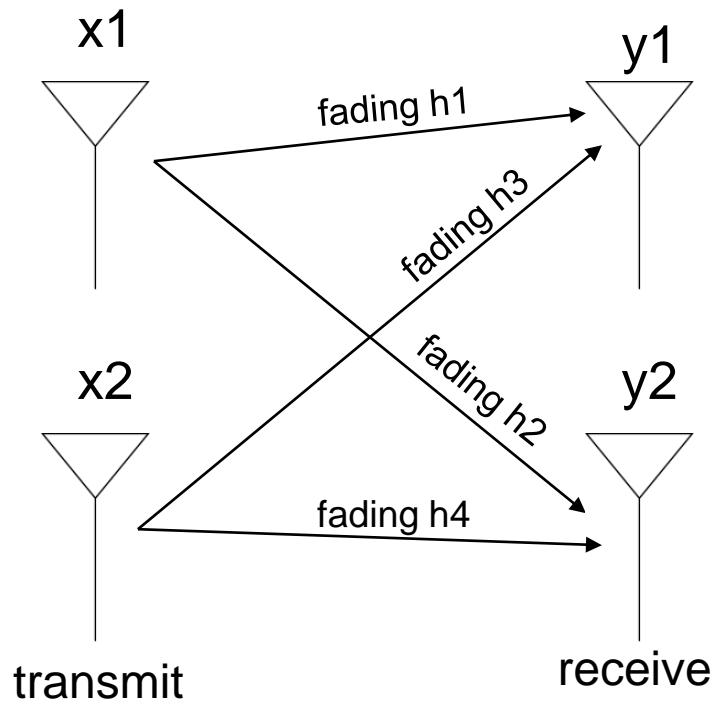

$$y_1 = h_1x_1 + h_2x_2$$

$$y_2 = h_3x_1 + h_4x_2$$

An audio metaphor



SISO



SIMO

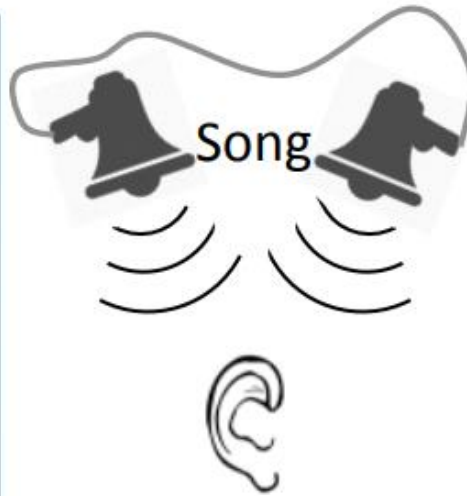

MISO

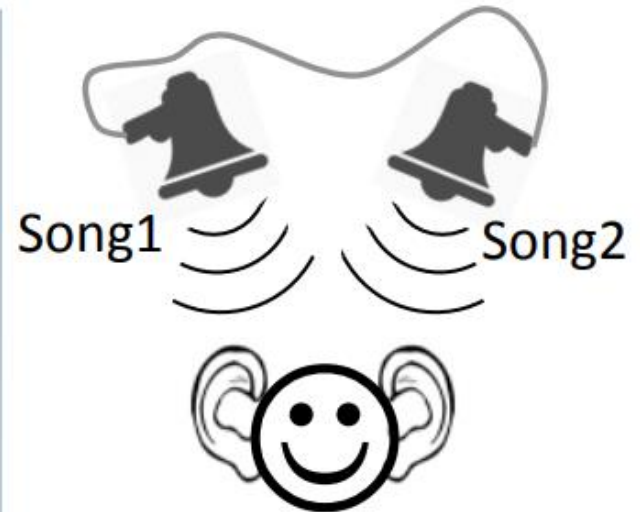

MIMO

MIMO brings

```
graph TD; A[MIMO brings] --> B[Diversity gain]; A --> C[Array gain]; A --> D[Spatial multiplexing gain]; B --> E[Decorrelates fading through different transmission paths]; C --> F[Provides a beamforming effect that focuses radiated energy in the direction of the receiver]; D --> G[Enables multiple data streams to be transmitted on the same frequency/time resource];
```

Diversity gain

Decorrelates fading through different transmission paths

Array gain

Provides a beamforming effect that focuses radiated energy in the direction of the receiver

Spatial multiplexing gain

Enables multiple data streams to be transmitted on the same frequency/time resource

Multi antenna configuration

- LTE uses of multiple antennas at both communication ends
- LTE-A standard supports for
 - 8 antennas at the eNodeB
 - 4 antennas at the UE
- Multiple antennas may be used in **three** principle ways
 - Reception/transmission diversity
 - Beam forming
 - Spatial multiplexing (MIMO antenna processing)
- Downlink MIMO
 - TX diversity
 - Beam forming
 - Spatial multiplexing
- Uplink MIMO
 - Multi user MIMO (SDMA)

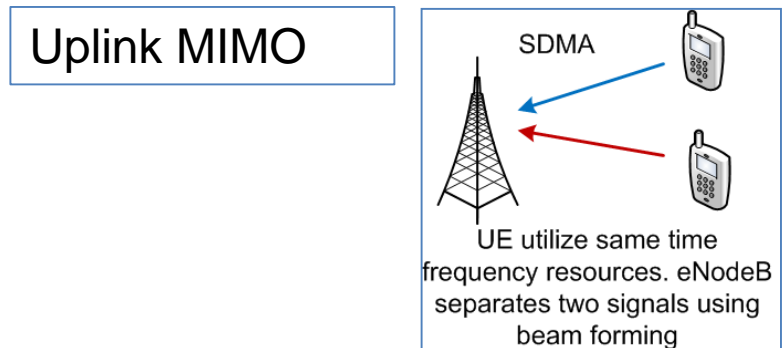
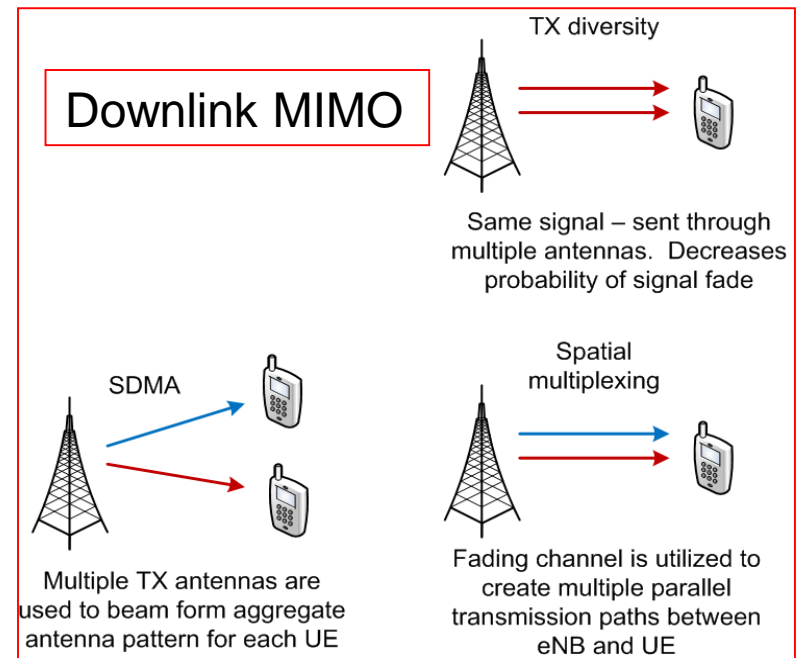

Beamforming

Regular Antenna:

Like a Light Bulb: radiates energy in all directions.
This results in wasted RF energy and interference.

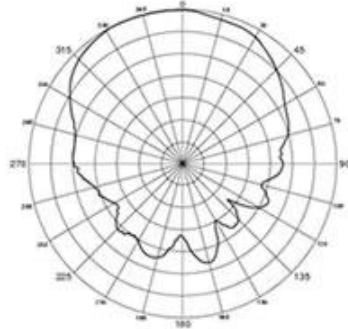

Smart Antenna (Beamforming):

Like a Torchlight: focuses the radio beam in the needed direction.
This results in stronger signal and less wasted RF energy.

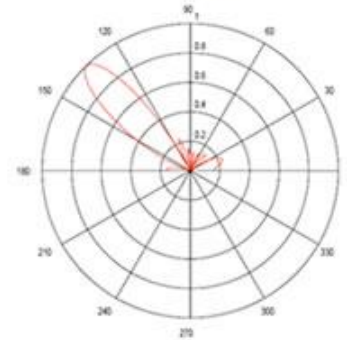

- Transmitter detects the positions of reception devices and transmits focused point-to-point signals with directionality
- Mitigates interference and reinforces signal of interest
- Strong stable transmission covering longer range

Positioning in LTE

- OTDOA (Observed Time Difference of Arrival)

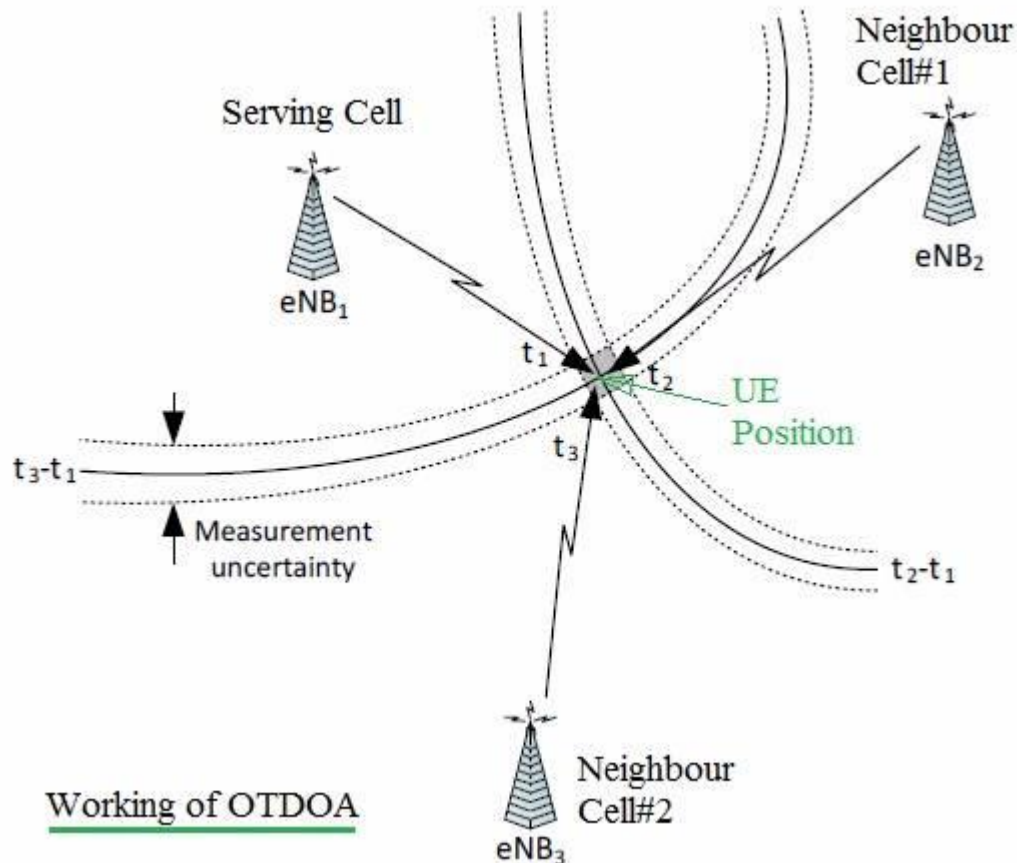

Beamforming

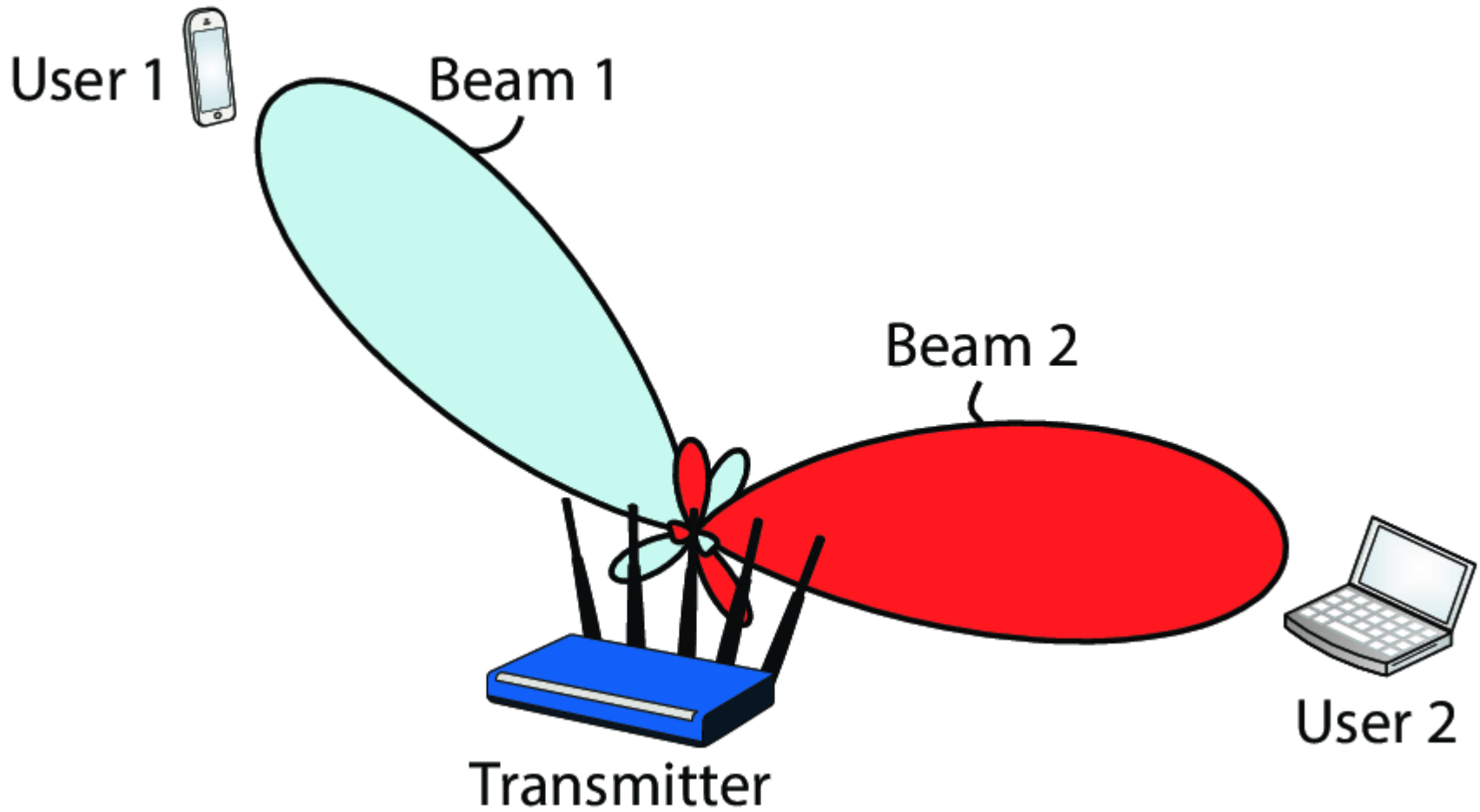

Beamforming

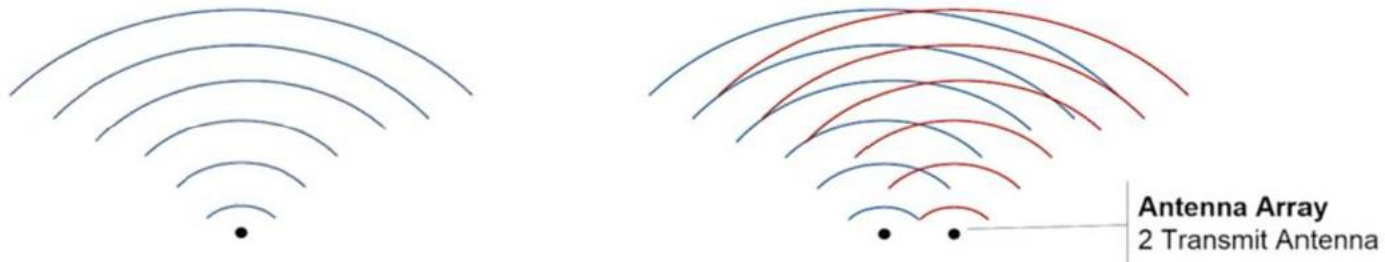

↑ Main Beam
(Lobe)
Direction

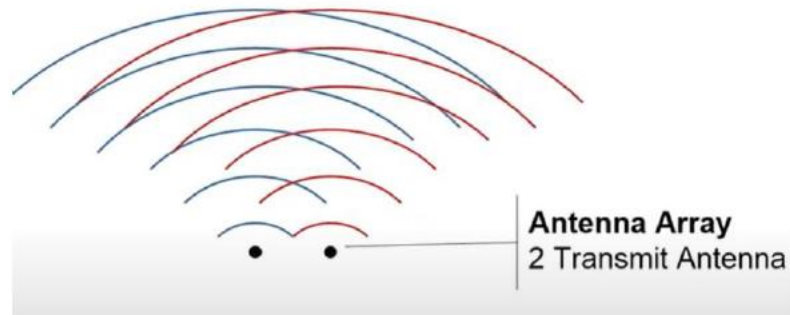

Radiating Elements and Antennas

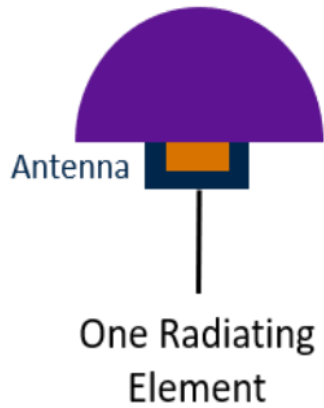

Radiating Elements and Antennas

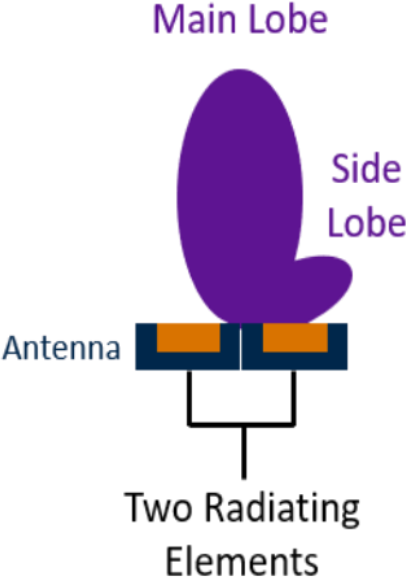
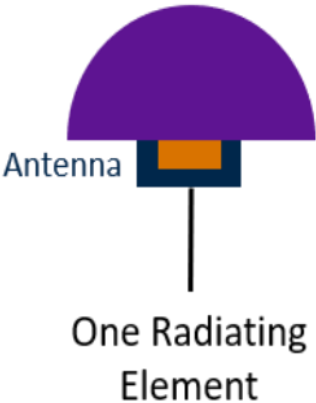

Radiating Elements and Antennas

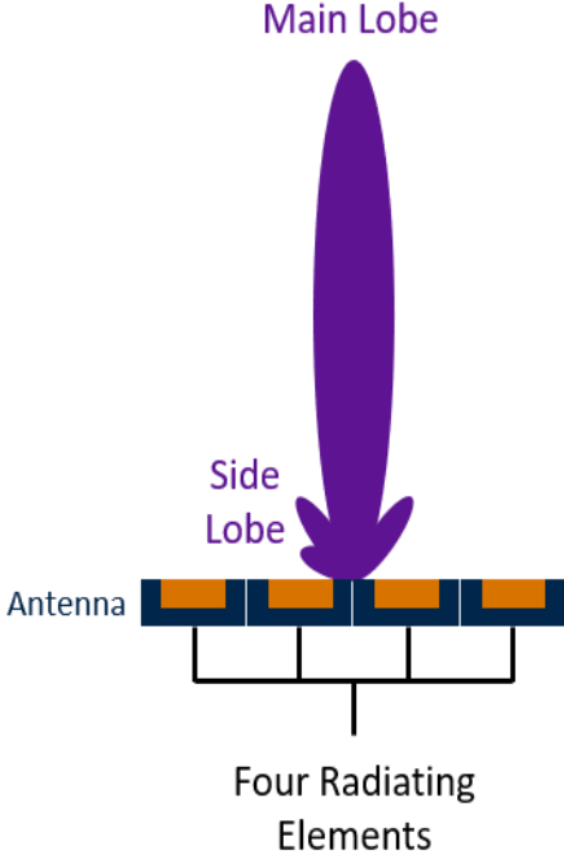
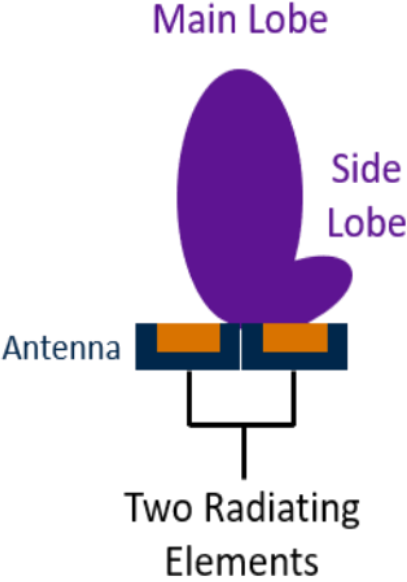
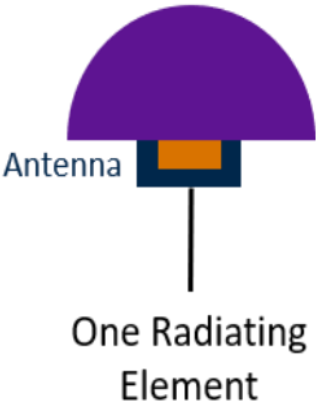

Antenna Gain (dB) = Element Gain + 10 log₁₀(N)

N = number of array Elements

Antenna Gain = 0
dB

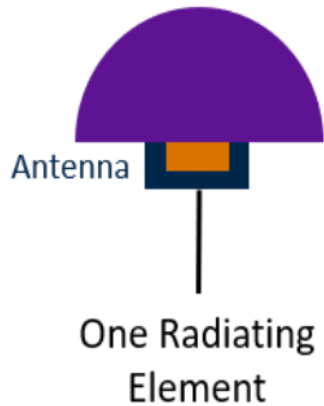

Antenna Gain = 3
dB

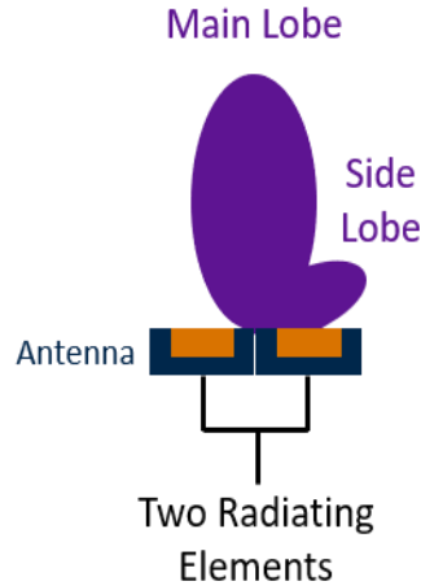

Antenna Gain = 6
dB Main Lobe

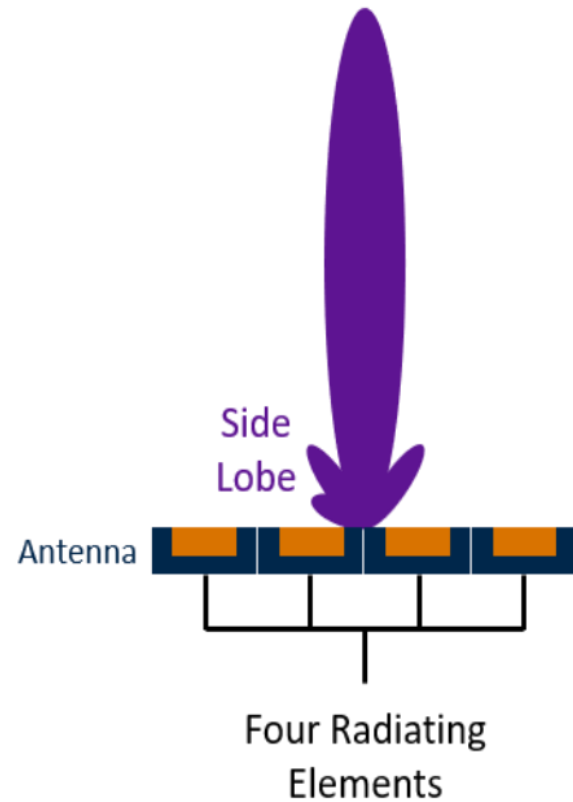

Beamforming

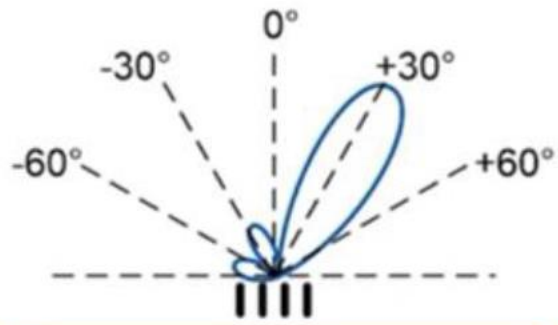
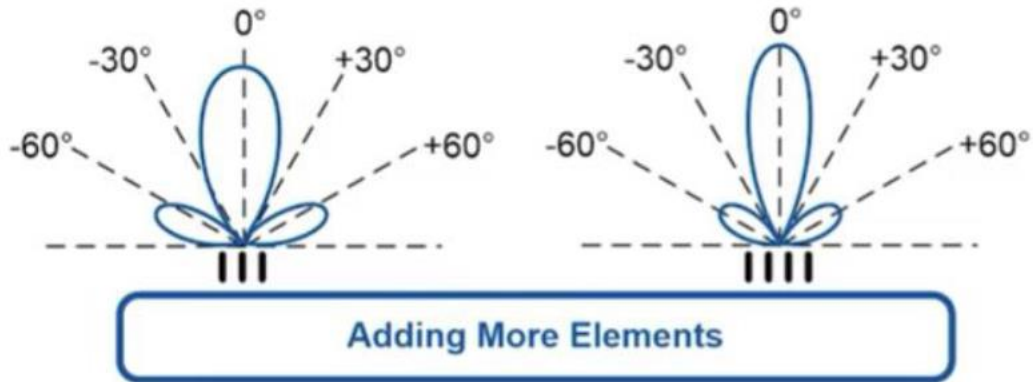

Adding a Phase Change
"Phased Array"

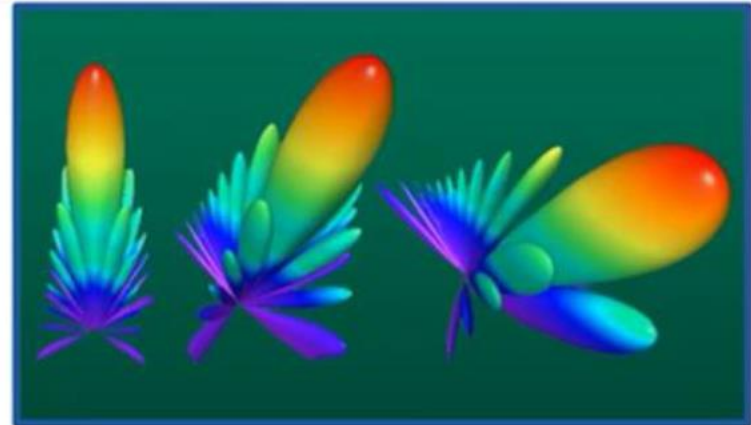

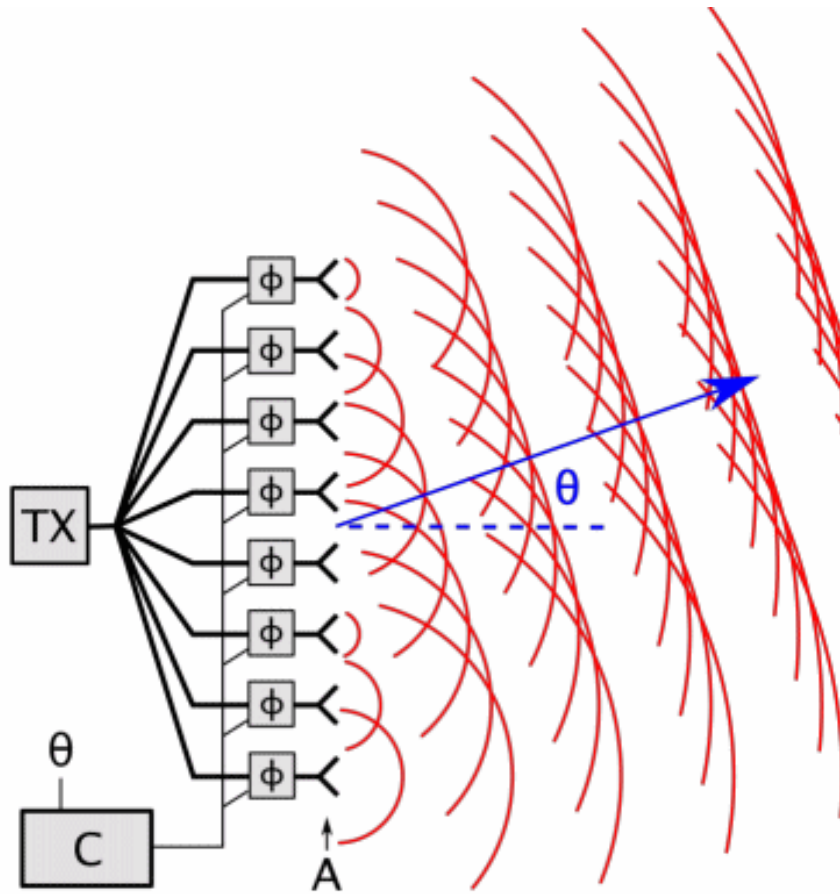

Visual representation of Phased Array

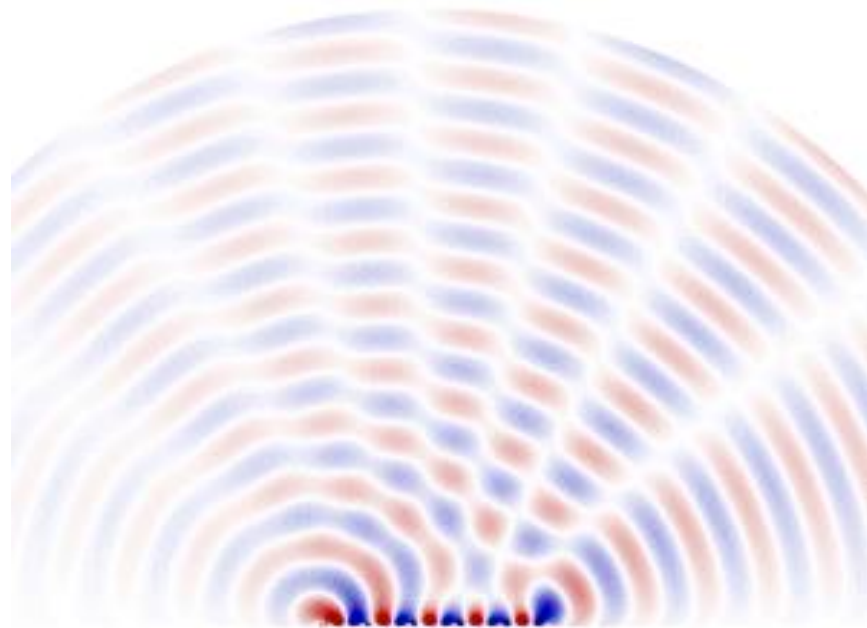

Visual representation of Phased Array

Patterns, beamwidth & Gain

top view(horizontal)

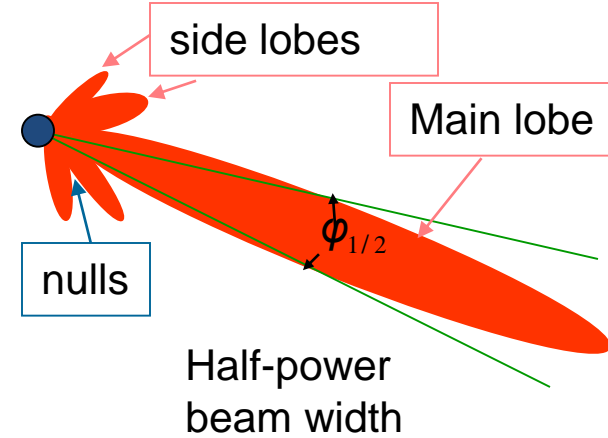
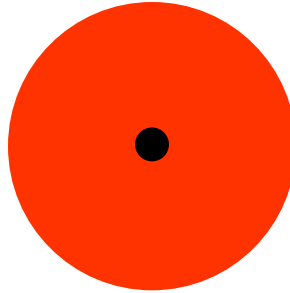
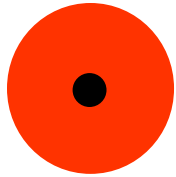

side view(vertical)

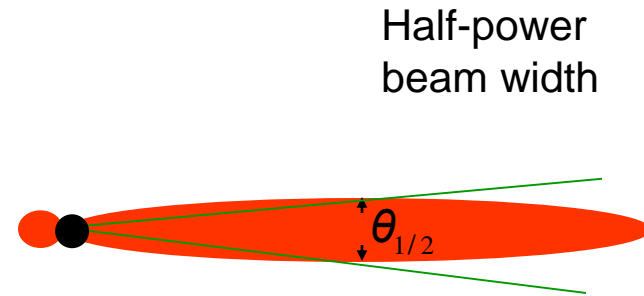
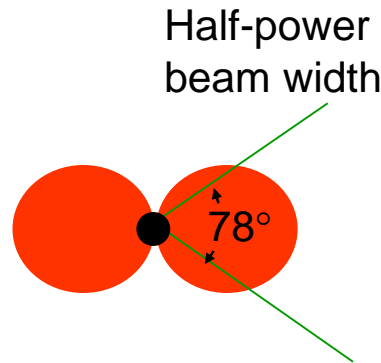

Isotropic dipole

half-wave dipole

beamformer

Towards 5G: Massive MIMO and beamforming

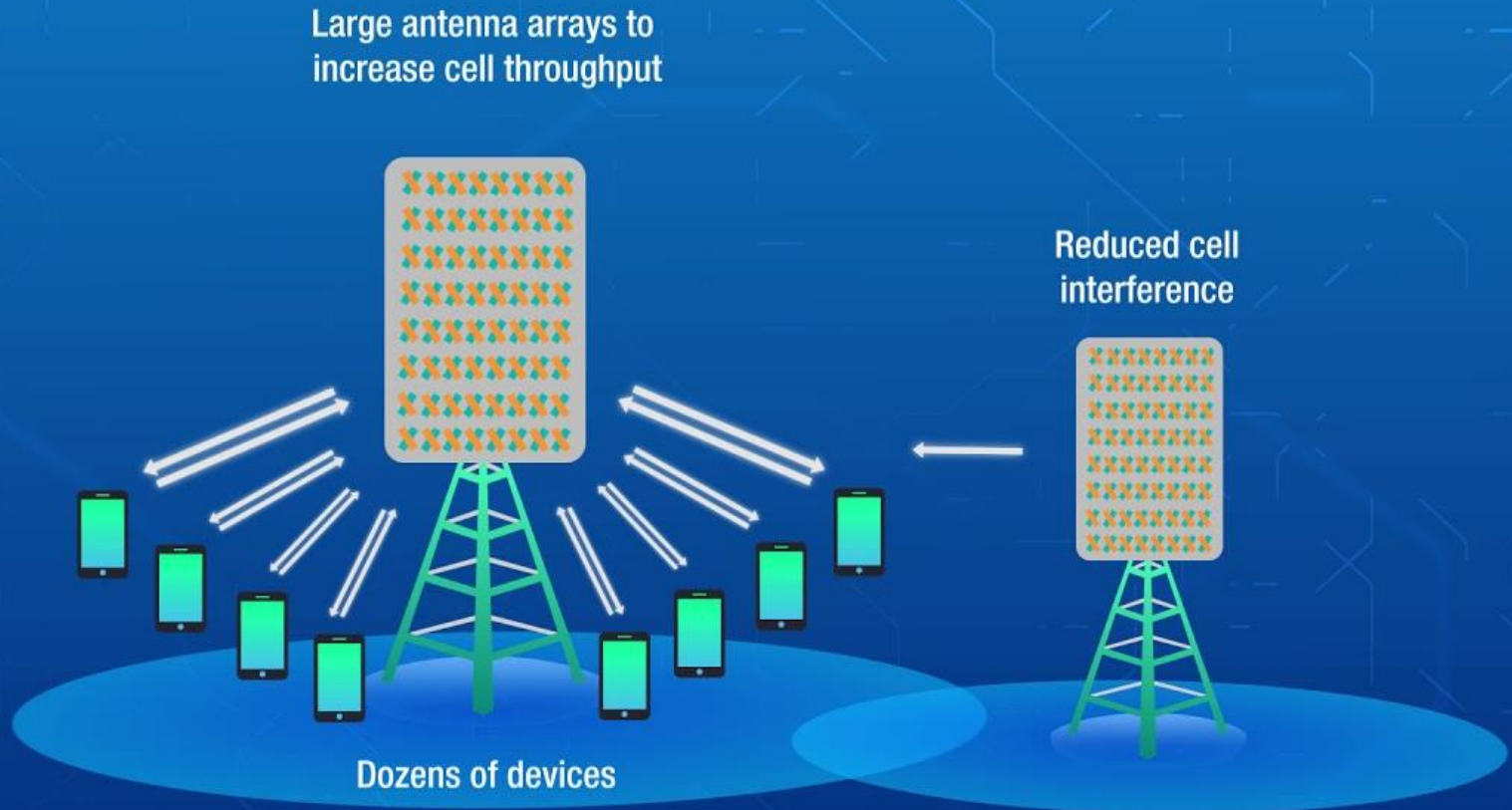

Different MIMO capabilities

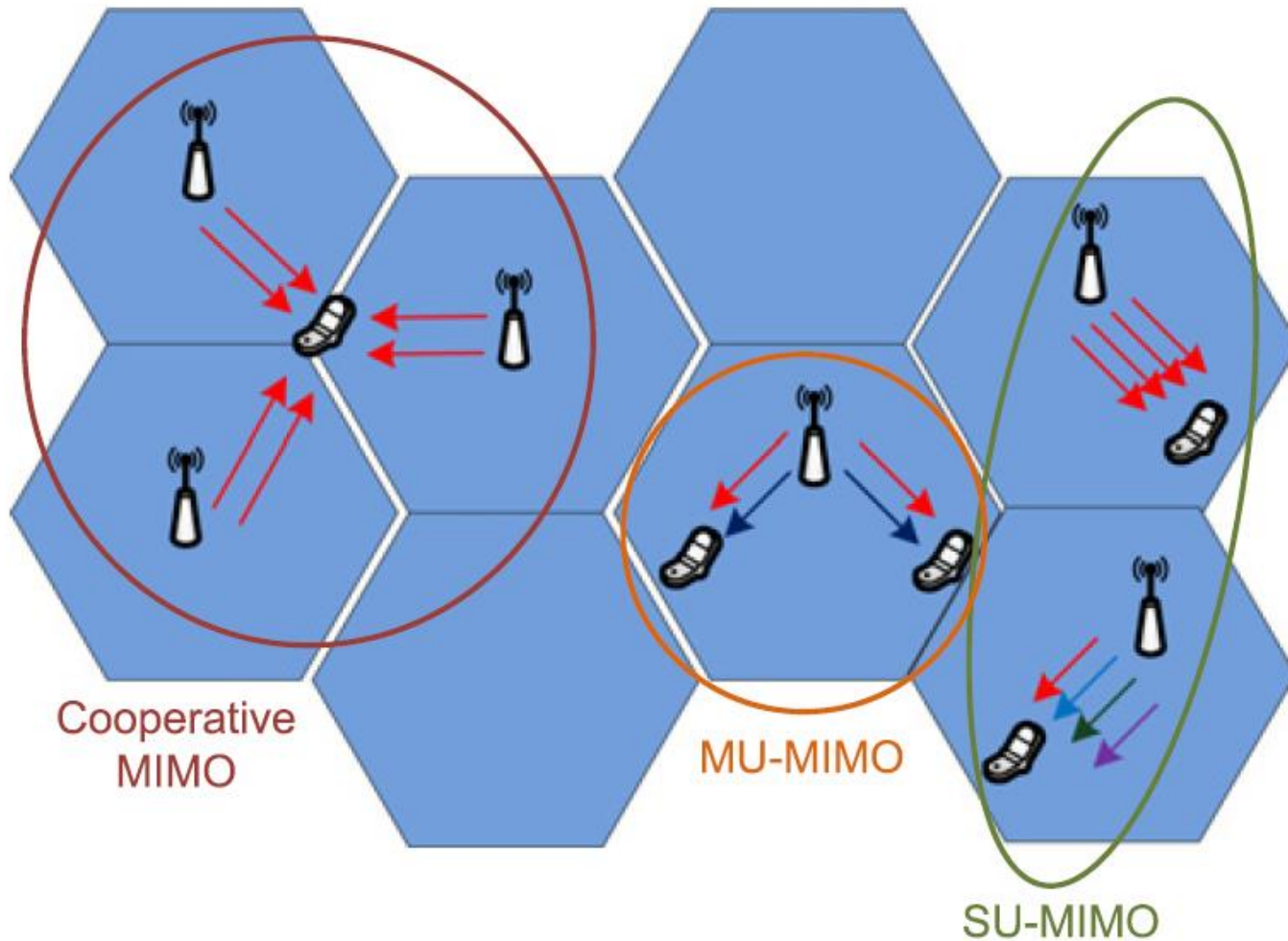

Different MIMO capabilities

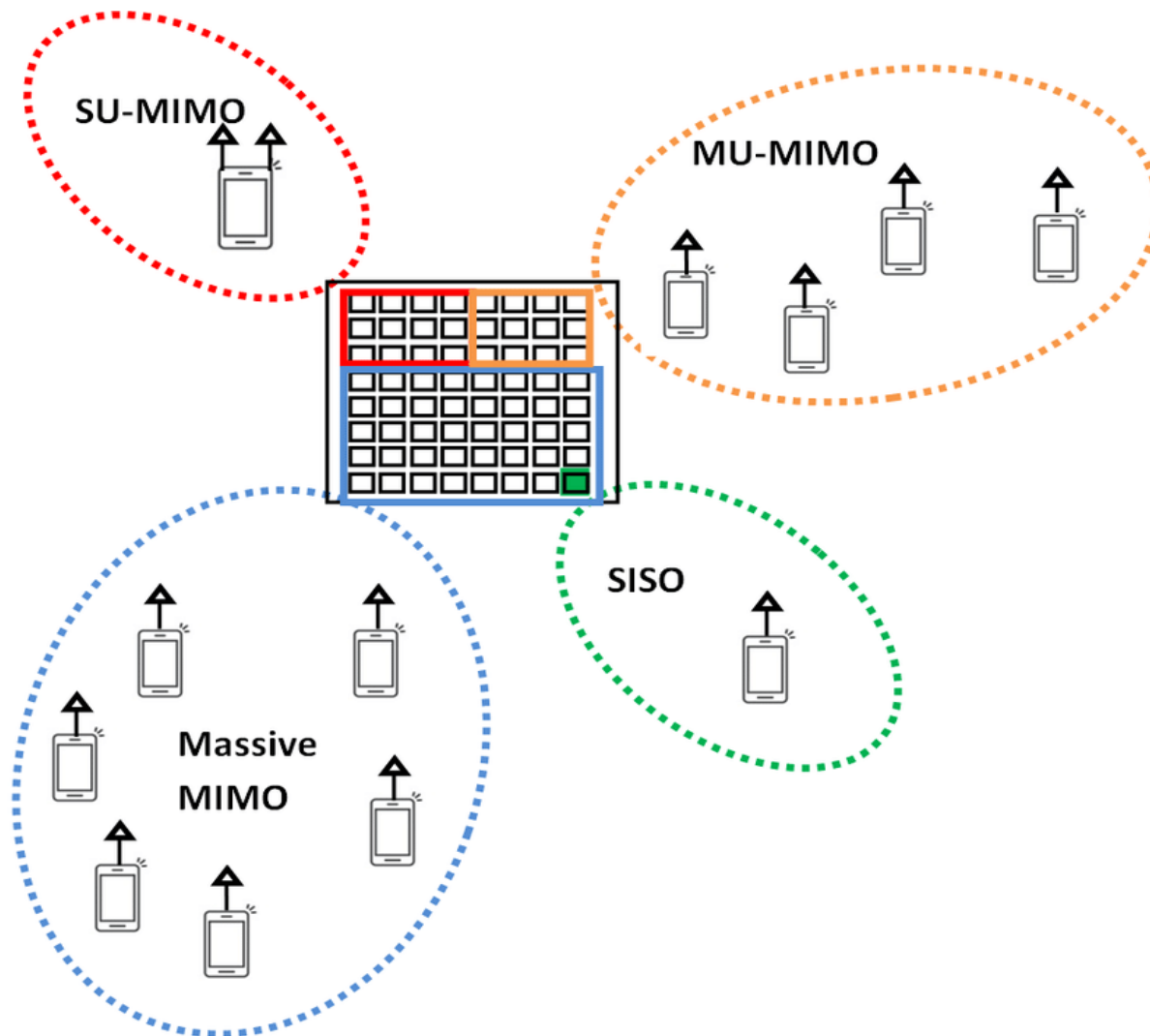

A. Beamforming

Serve single users by directing the energy toward the user.



B. Generalized beamforming

Serve single users by sending the same data stream in different directions and possibly forming zero (nulls) in the directions of other users.

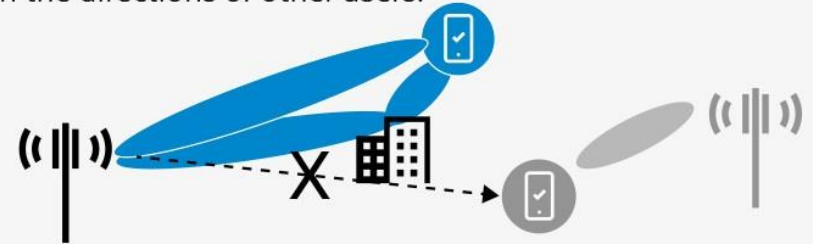

C. SU-MIMO

Increase data rates by transmitting several data streams to a user.



D. MU-MIMO

At high load, serve more users simultaneously at high load.

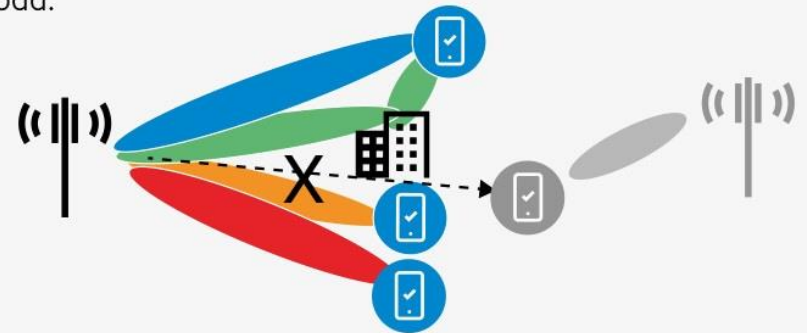

SU MIMO: (cell center)
4 Tx, Rank 4

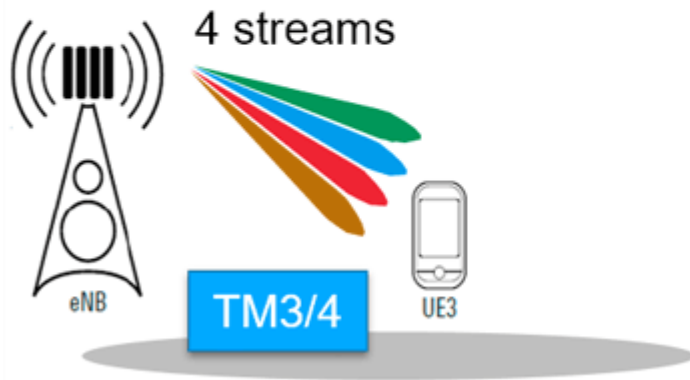

SU MIMO: (mid cell)
4 Tx, Rank 2

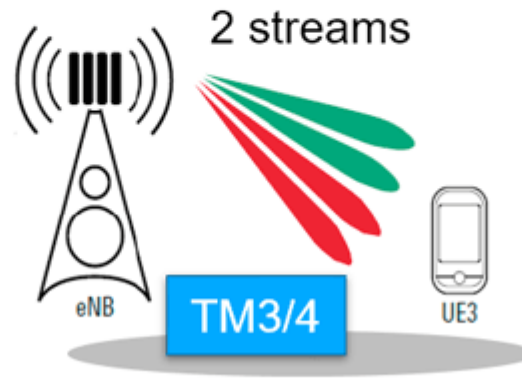

SU MIMO: (cell edge)
4 Tx, Rank 1

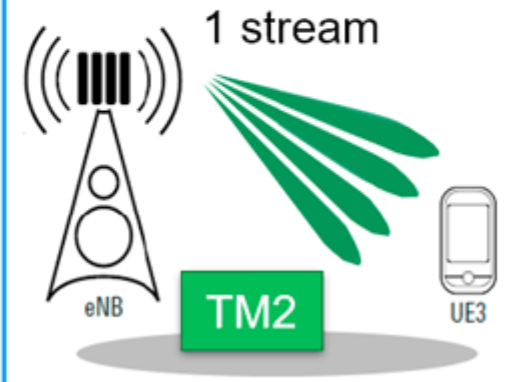

Transmission modes

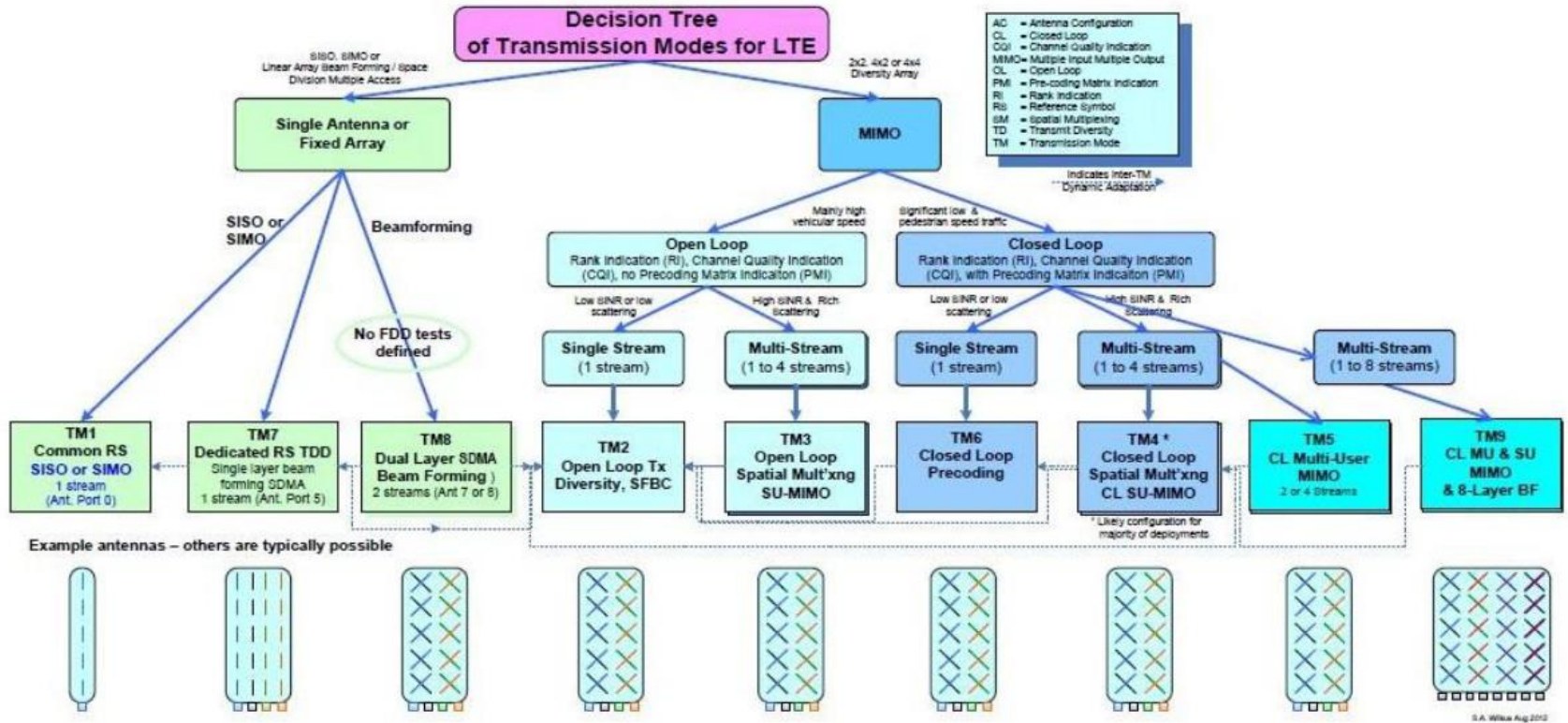
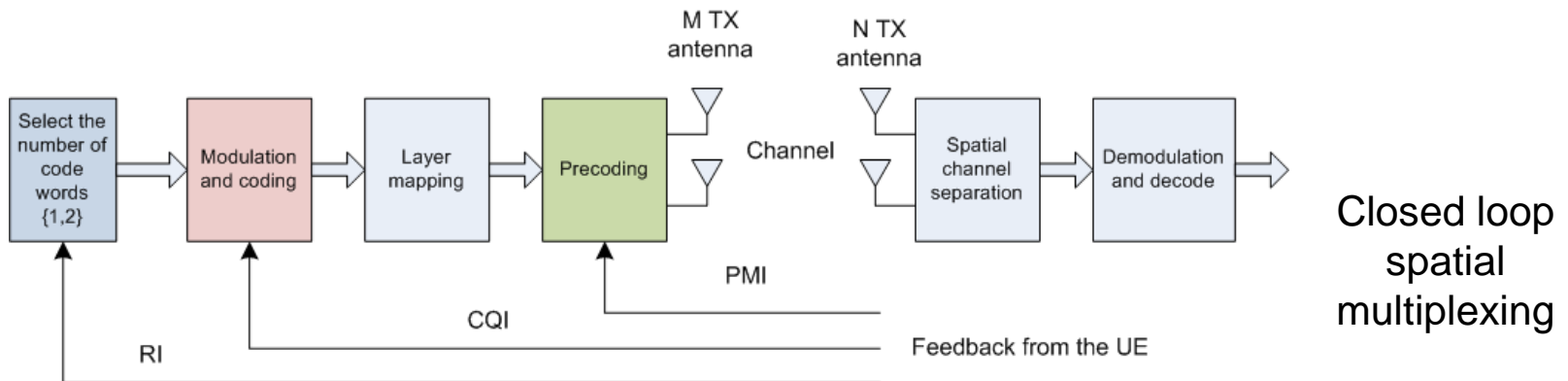

Figure 3 – Taxonomy of smart antenna processing algorithms in LTE Release 10. Shadows behind blocks indicate that they are capable of transmitting multiple streams. (LTE Release 11 recently added Transmit Mode 10 with explicit support for CoMP (Coordinated MultiPoint Transmission Reception) use which is not shown.)

Spatial multiplexing in LTE

- Two types
 - Open loop (used high speed scenarios)
 - Large delay Cyclic Delay Diversity (CDD)
 - Closed loop (used in low speed scenarios)
 - Mobile provides channel feedback to eNode B

| Feedback | Closed loop spatial multiplexing | Open loop spatial multiplexing |
|----------------------------------|--|--|
| PMI (Pre-coded matrix indicator) | PMI feedback from UE based on instantaneous channel state | No feedback from UE. Fixed pre-coding at eNode B implementing cyclic delay diversity (CDD) |
| CQI (Channel quality indicator) | Separate CQI for each code word | Aggregate CQI (one value) |
| RI (Rank indicator) | Based on the rank of estimated channel matrix (indicates number of spatial channels) | Based on the rank of estimated channel matrix when SFBCs are used |



Antenna configurations (LTE)

- LTE defines 7 transmission modes
- Decision on transmission mode – scheduler at eNode B
- Implementation equipment vendor dependent
- Later LTE releases added more MIMO modes

| Transmission modes | Description | Comments |
|--------------------|----------------------------------|---|
| 1 | Single antenna (Port 0) | Used for SISO and SIMO transmission |
| 2 | Transmit diversity | Used in low SNR and high mobility |
| 3 | Open loop spatial multiplexing | Beneficial in high SNR and rich multipath environment |
| 4 | Closed loop spatial multiplexing | Beneficial in high SNR and rich multipath environment |
| 5 | Multi-user MIMO | Beneficial in high SNR environment for interference reduction |
| 6 | Closed loop | Beneficial in low SNR environments |
| 7 | Single antenna port | Used for beam forming of antenna arrays |

TM1: SIMO mode

- Default transmission mode
- Every other mode – explicit signaling
- Assumes one TX port (i.e. one antenna)
- Mobile still may use diversity reception
- Not used often – limits the performance of DL
- Typical uses:
 - eNode B with one physical antenna
 - Simple UE with a very low traffic requirements
 - M2M communication (simplified signaling)
 - Limited coverage area

TM 2: DL transmit diversity

- Two implementations
 - Cyclic Delay Diversity (CDD)
 - Space-Time Transmit Diversity (STTD)
- CDD
 - Multiple antenna elements are used to introduce additional versions of the signal that are cyclically delayed
 - UE perceives these signals as additional multi-paths
 - Assuming low correlations between TX antennas –created “multi-paths” fade independently – source of diversity
- STTD
 - Uses Space-Frequency Block Codes
 - Special encoding (SFBC) makes the channel matrix unitary (full rank)
 - Reference symbols are used to estimate and invert channel matrix

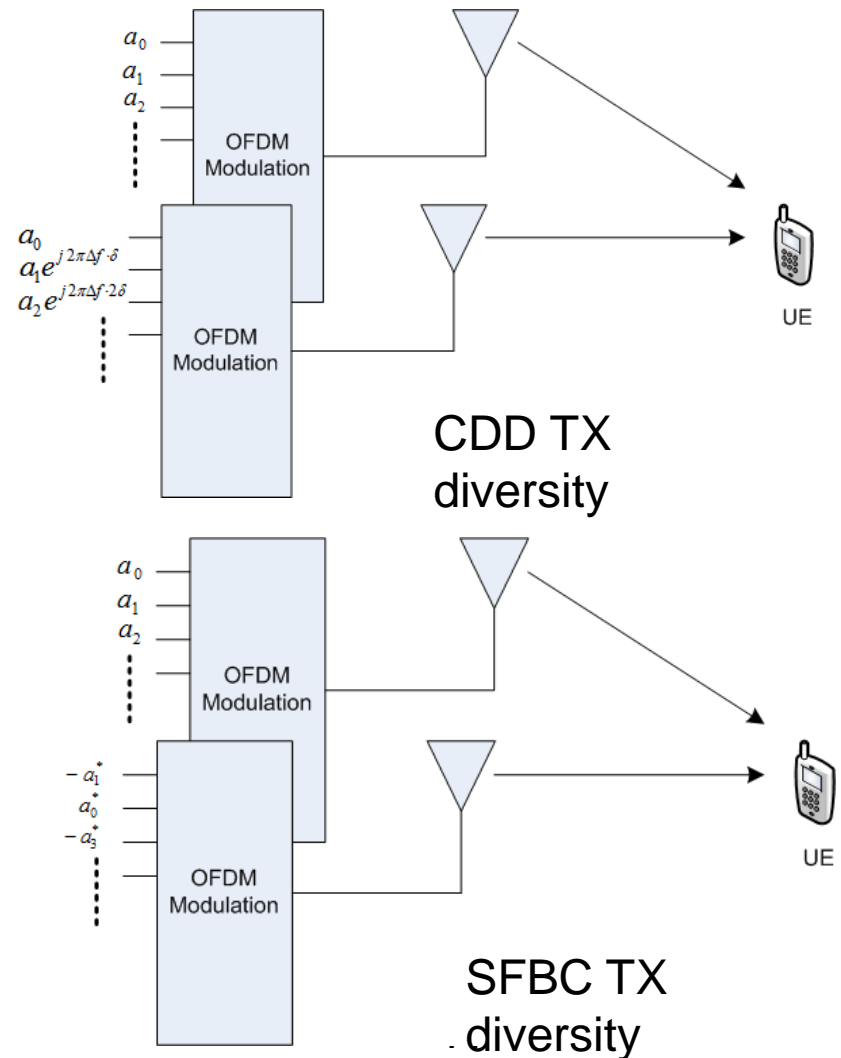

TM 3/4: Open/Closed loop spatial multiplexing

- Open loop = no PMI, CQI and Rank are still provided
- Closed loop = PMI, CQI and Rank provided by UE
- 2 layers with different information on each layer
- Rank of channel is 2
- May use 2 or 4 ports (antennas)
- If four antennas are used CDD is used on the same layer
- No PMI, eNodeB cycles through a pre-defined sequence of PMIs (TM3)
- PMI present = eNodeB uses the UE recommended PMI (TM4)

Note 1: UE recommends transmission mode configuration; UEs of different capabilities easily accommodated

Note 2: PMI estimates only valid for slow moving mobiles

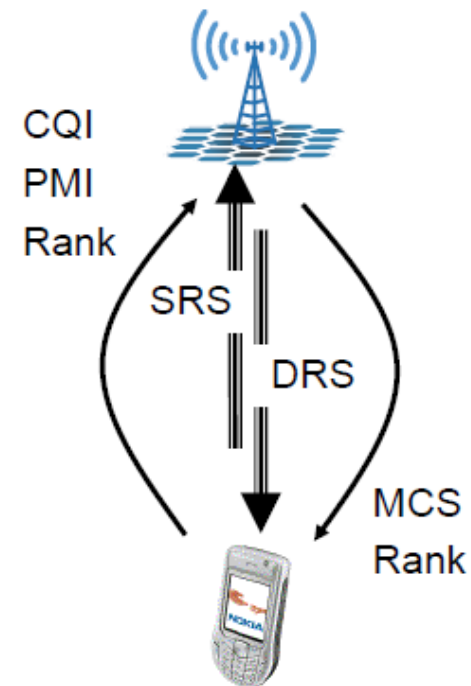

PDSCH Channel estimation based on DRS

TM 5/6: MU-MIMO/Closed Loop

TM 5

- Users are multiplexed in spatial domain
- Scheduling for multiple users
 - Same frequency resources
 - Different layers
- Requires very precise channel estimation
- Not used much in practice

TM 6

- One layer (i.e. one code word)
- PMI selected by the UE
- Appropriate for slow moving mobiles
- Not used much in practice

TM 7: Beam forming

- Transmission mode used for beamforming
- Multiple antennas are used to form a higher gain beam towards the mobile
- This is accomplished through phase and amplitude scaling of individual ports
- This is rank 1 technique, i.e. it does not support spatial multiplexing
- Used predominantly as means to help UE's at cell edge

Note: transmission uses multiple antennas that are combined to act as a single high gain antenna

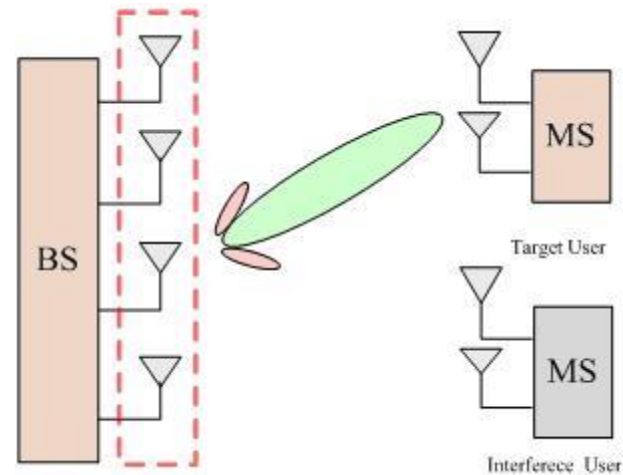

MIMO mode selection in LTE

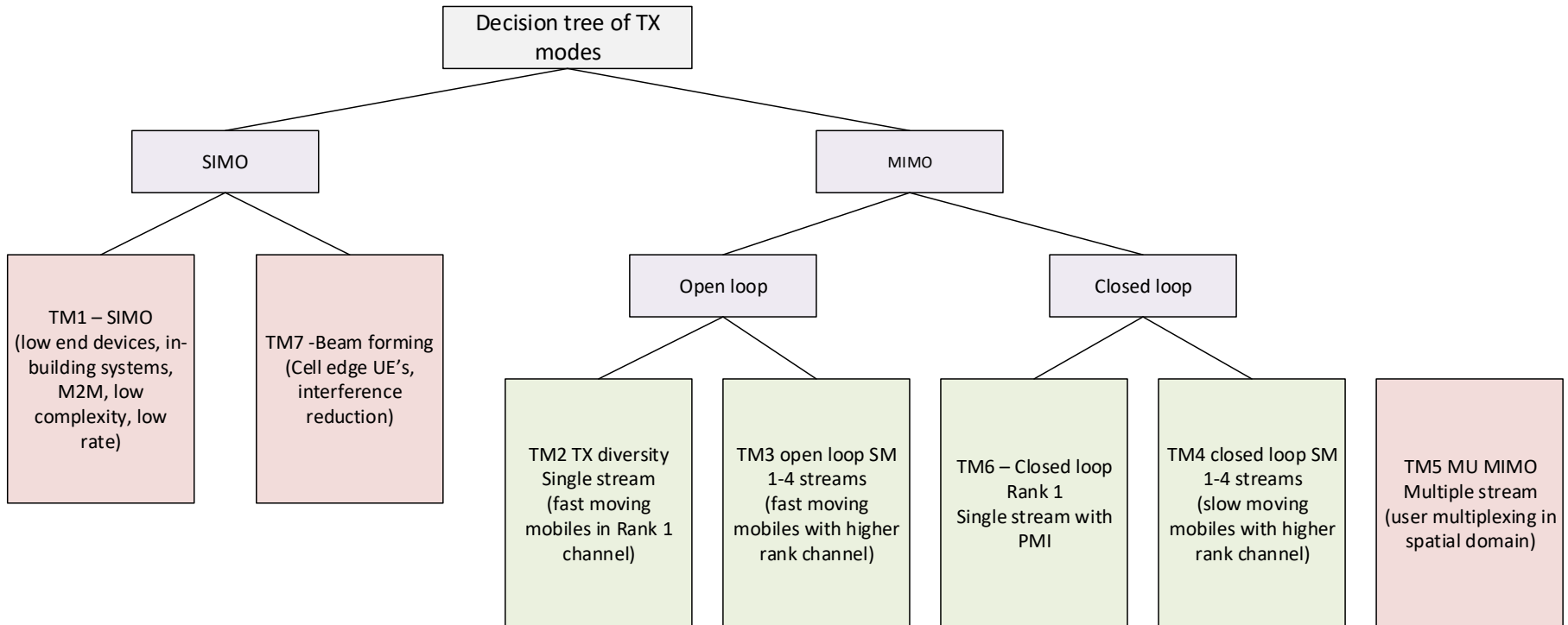

Note: “Green” modes are used more frequently than “red” modes.

Typical distribution of MIMO modes

- Use of MIMO mode – scheduler decision
- Most useful modes:
 - TM4 (spatial multiplexing over rank 2 channel with precoding)
 - TM3 (spatial multiplexing over rank channel without pre-coding)
 - TM2 (transmit diversity)
 - TM6 (closed loop MIMO over Rank 1 channel)

Example of an area and MIMO mode distribution

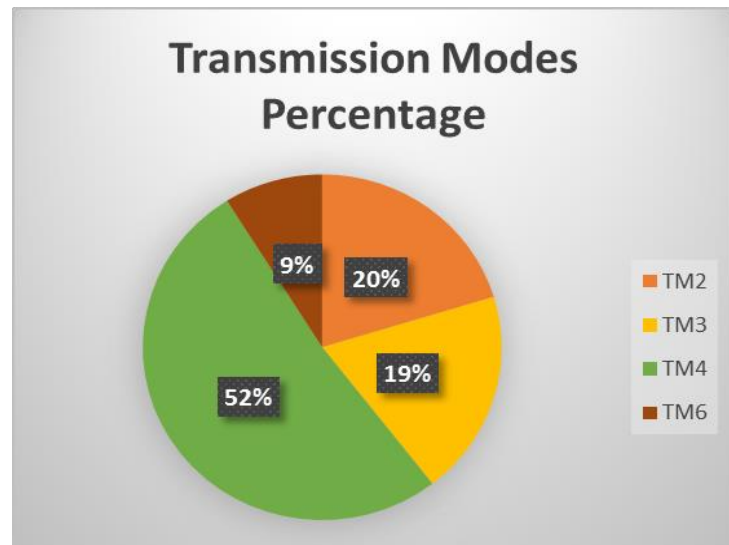
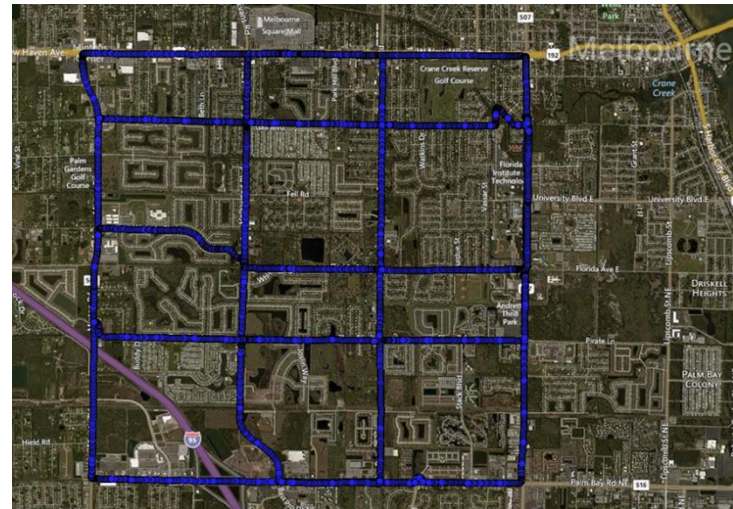

LTE-A main features

Support of Wider Bandwidth(Carrier Aggregation)

- Use of multiple component carriers(CC) to extend bandwidth up to 100 MHz
- Common physical layer parameters between component carrier and LTE Rel-8 carrier
- ➔ Improvement of peak data rate, backward compatibility with LTE Rel-8

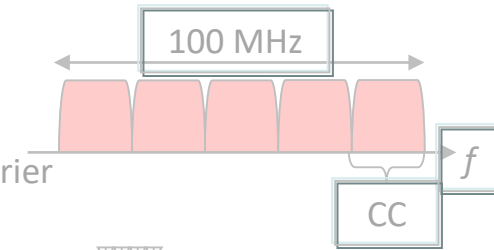

Advanced MIMO techniques

- Extension to up to 8-layer transmission in downlink
- Introduction of single-user MIMO up to 4-layer transmission in uplink
- Enhancements of multi-user MIMO
- ➔ Improvement of peak data rate and capacity

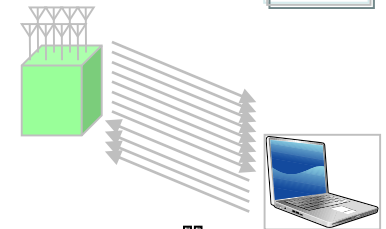

Heterogeneous network and eICIC (enhanced Inter-Cell Interference Coordination)

- **Interference coordination** for overlaid deployment of cells with different Tx power
- ➔ **Improvement of cell-edge throughput and coverage**

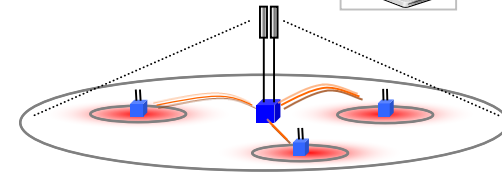

Relay

- Supports radio backhaul and creates a separate cell and appear as Rel. 8 LTE eNB to Rel. 8 LTE UEs
- ➔ Improvement of coverage and flexibility of service area extension



Coordinated Multi-Point transmission and reception (CoMP)

- Support of multi-cell transmission and reception
- ➔ Improvement of cell-edge throughput and coverage

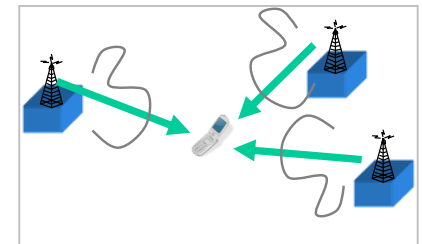

Heterogeneous networks in LTE-A

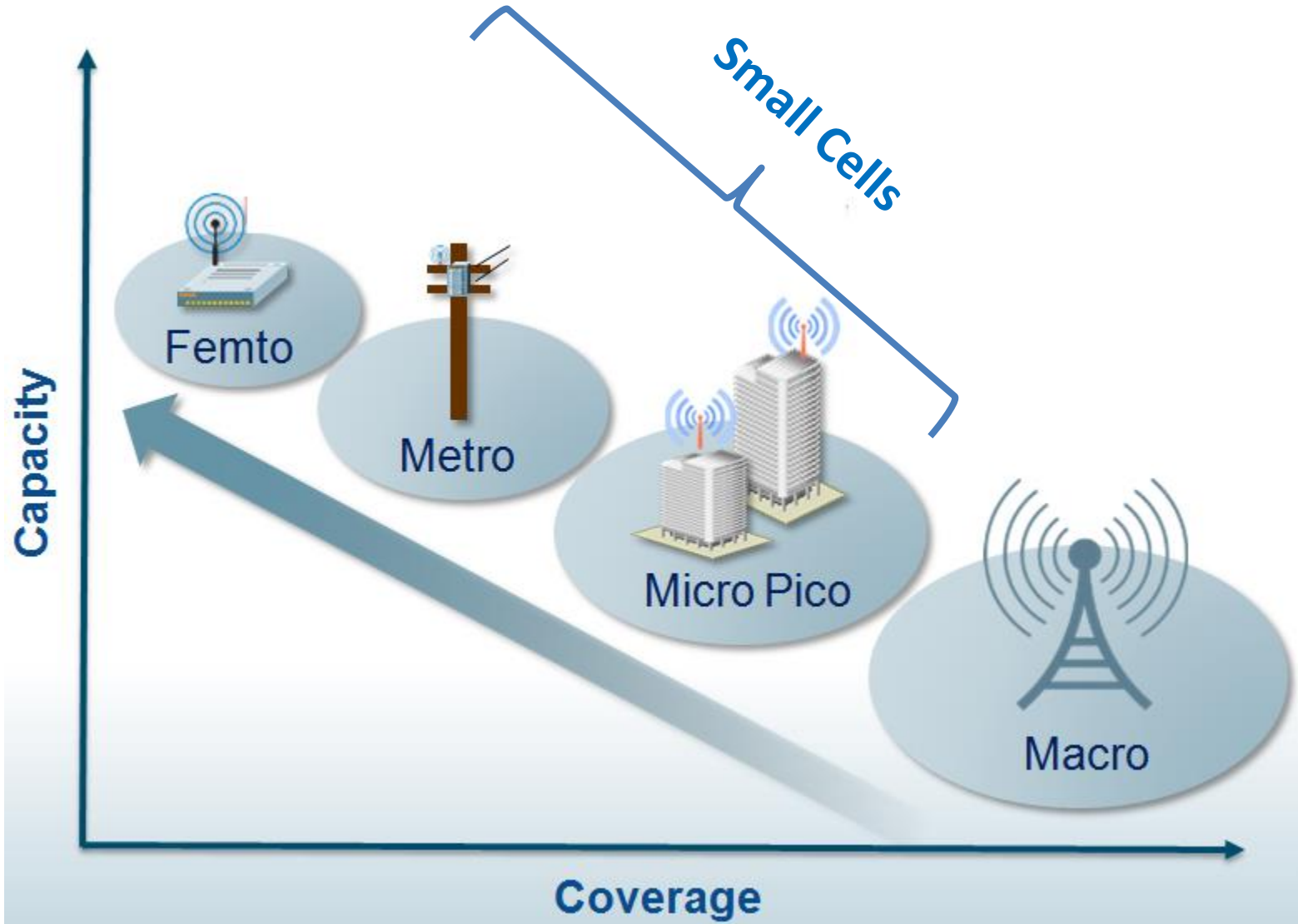

Heterogeneous networks in LTE-A

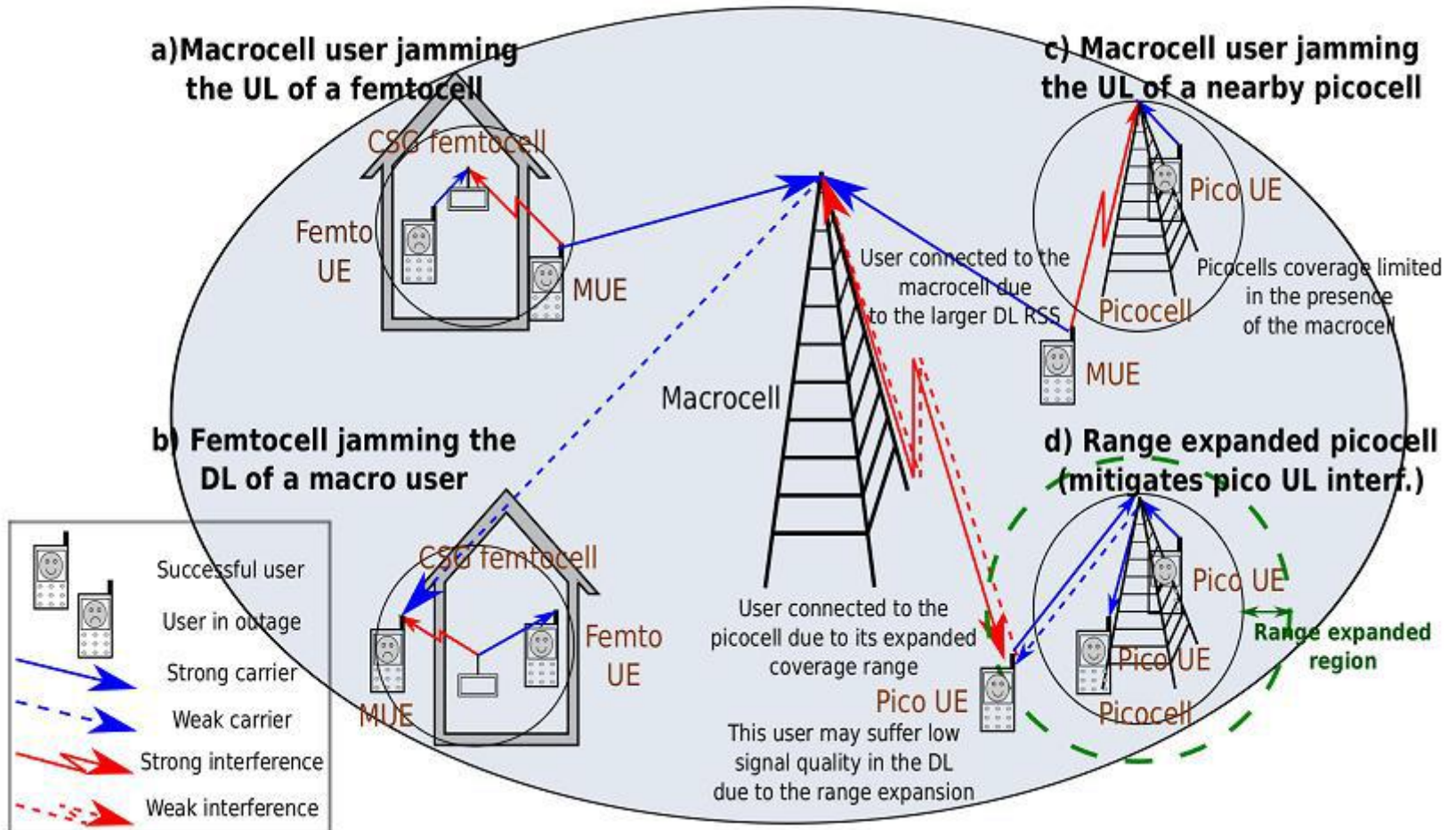

enhanced Inter-Cell Interference Coordination (eICIC)

- Coordination between eNBs at **different tiers** (e.g. femto-macro) to mitigate interference
- Three categories
 - Time-domain: **Almost Blank Subframes** (ABSFs) at macrocells, where no control or data signals are transmitted.
 - Frequency-domain: Select **different frequency** channels for victim users in macro and femto
 - Power-domain: **Reduce power in femtocell** to mitigate interference to macrocell

Almost Blank Subframes

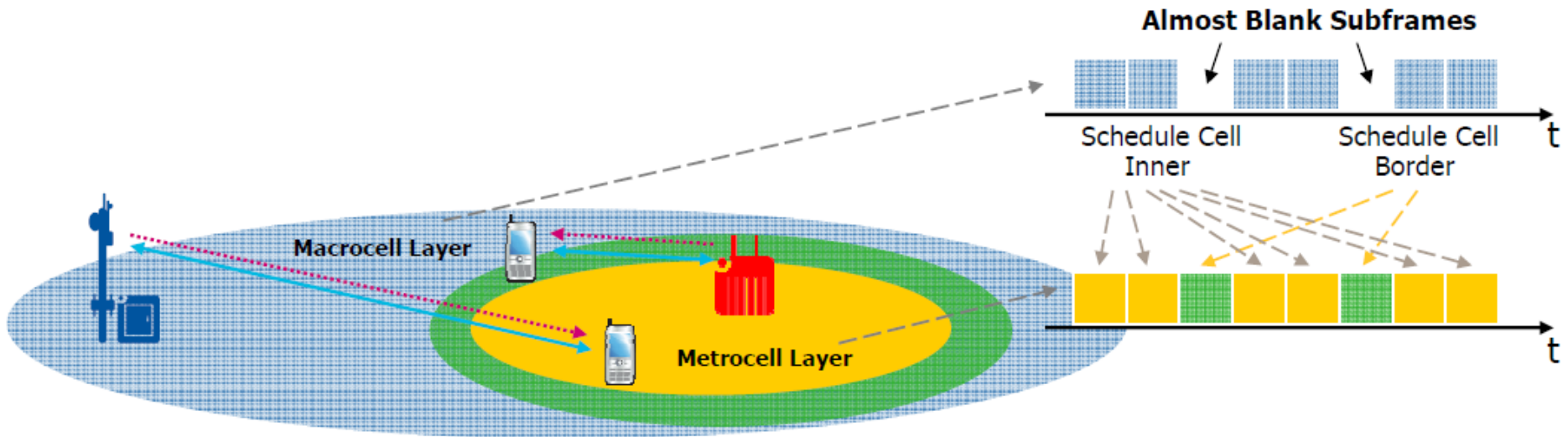

- Increased coverage
- Higher spectral efficiency
- Significant improvement in capacity and cell edge performance

Almost Blank Subframes

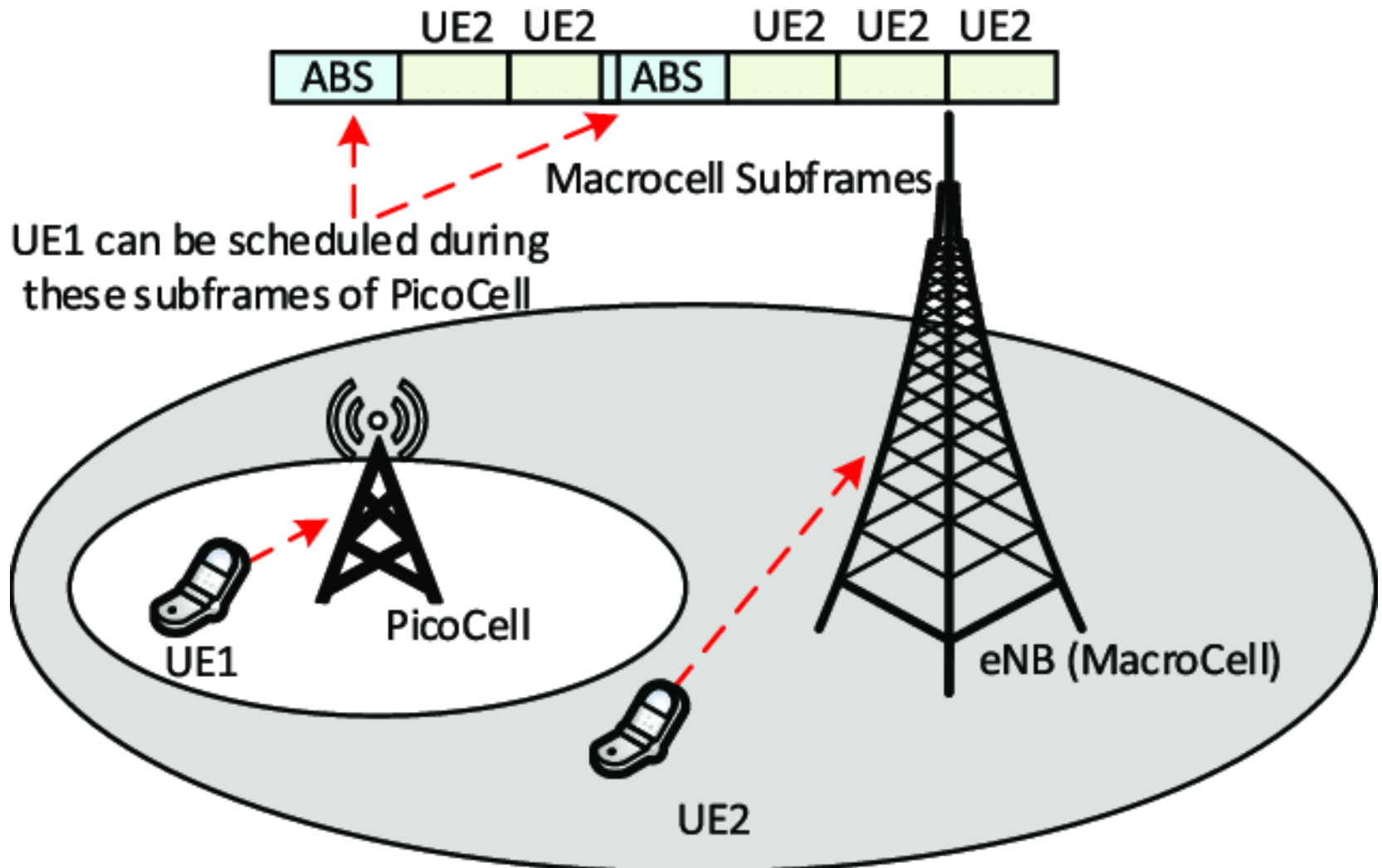

Almost Blank Subframes

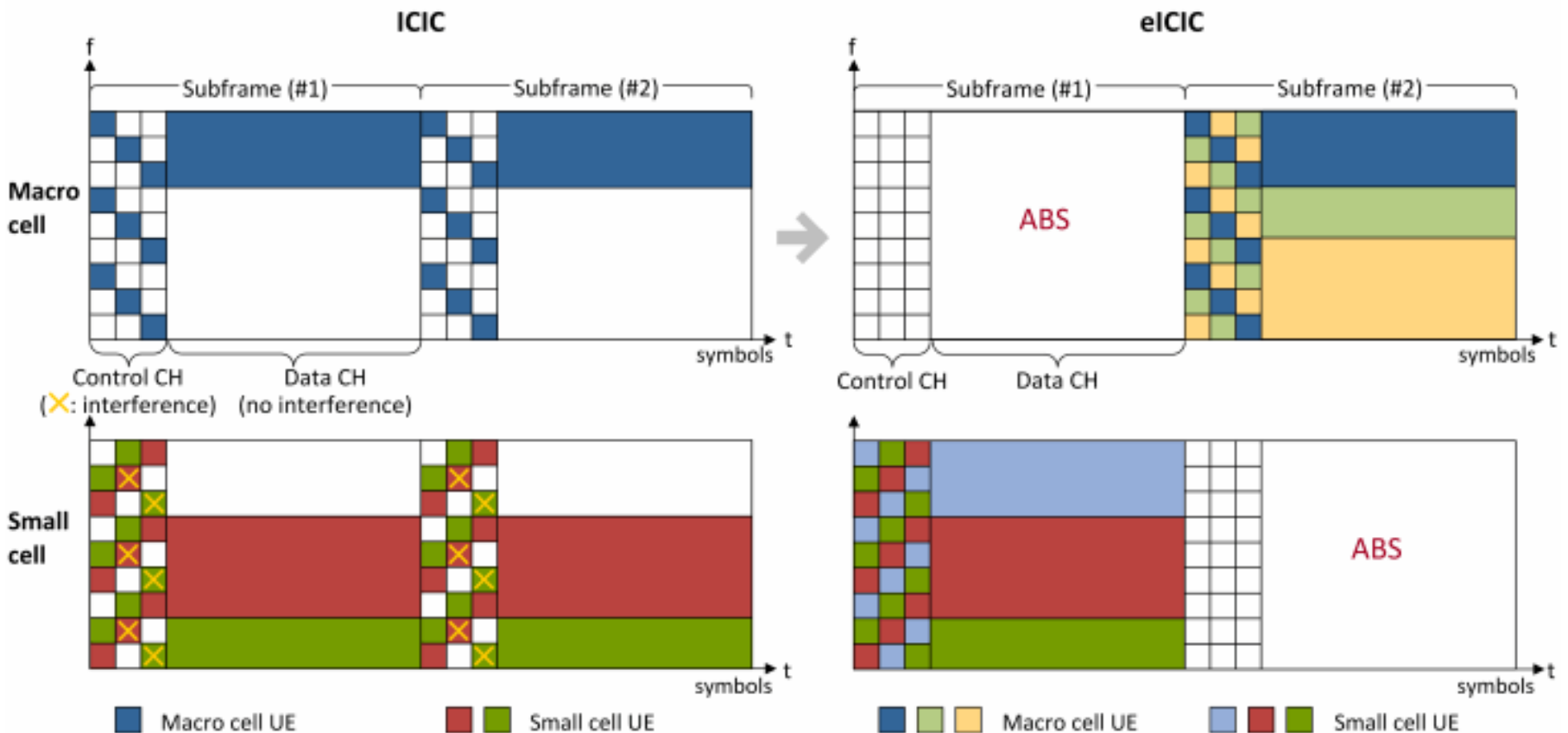

Release 8 (LTE)

Release 10 (LTE-A)

LTE-A main features

Support of Wider Bandwidth(Carrier Aggregation)

- Use of multiple component carriers(CC) to extend bandwidth up to 100 MHz
- Common physical layer parameters between component carrier and LTE Rel-8 carrier
- ➔ Improvement of peak data rate, backward compatibility with LTE Rel-8

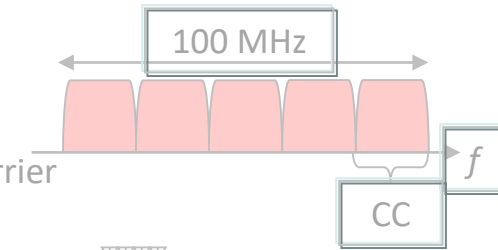

Advanced MIMO techniques

- Extension to up to 8-layer transmission in downlink
- Introduction of single-user MIMO up to 4-layer transmission in uplink
- Enhancements of multi-user MIMO
- ➔ Improvement of peak data rate and capacity

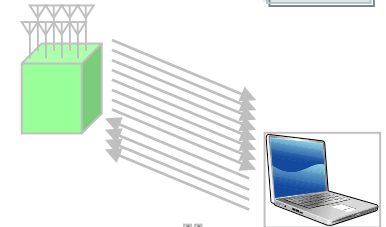

Heterogeneous network and eICIC (enhanced Inter-Cell Interference Coordination)

- Interference coordination for overlaid deployment of cells with different Tx power
- ➔ Improvement of cell-edge throughput and coverage

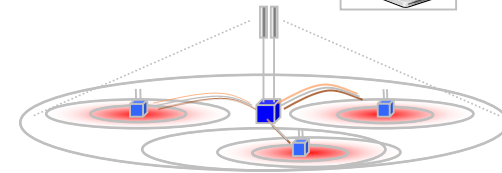

Relay

- Supports radio backhaul and **creates a separate** cell and appear as Rel. 8 LTE eNB to Rel. 8 LTE UEs
- ➔ **Improvement of coverage and flexibility** of service area extension

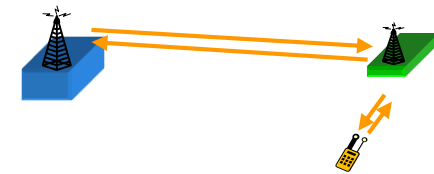

Coordinated Multi-Point transmission and reception (CoMP)

- Support of multi-cell transmission and reception
- ➔ Improvement of cell-edge throughput and coverage

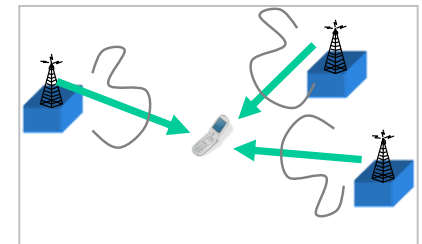

Relaying in LTE-A

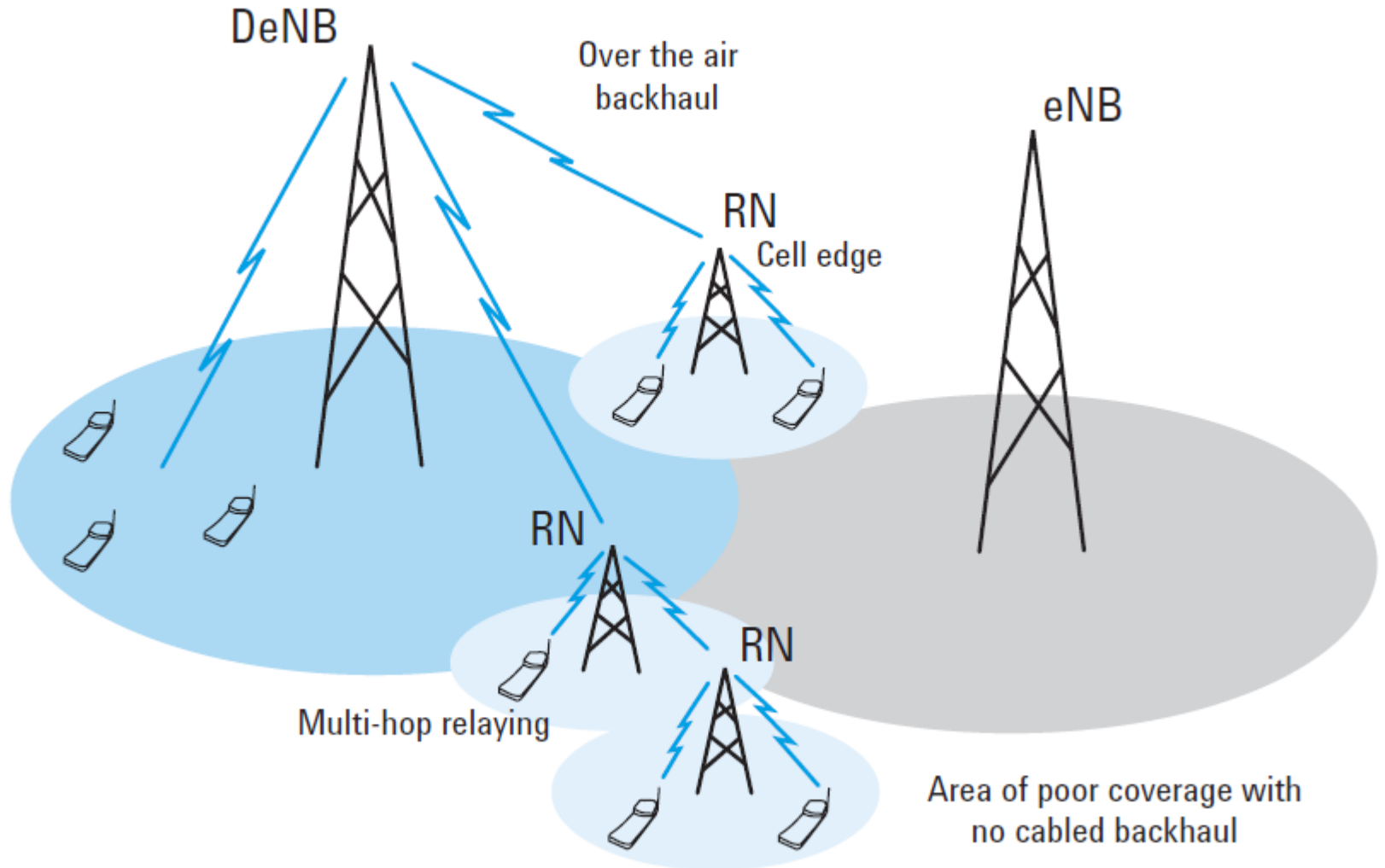

Where to use relaying

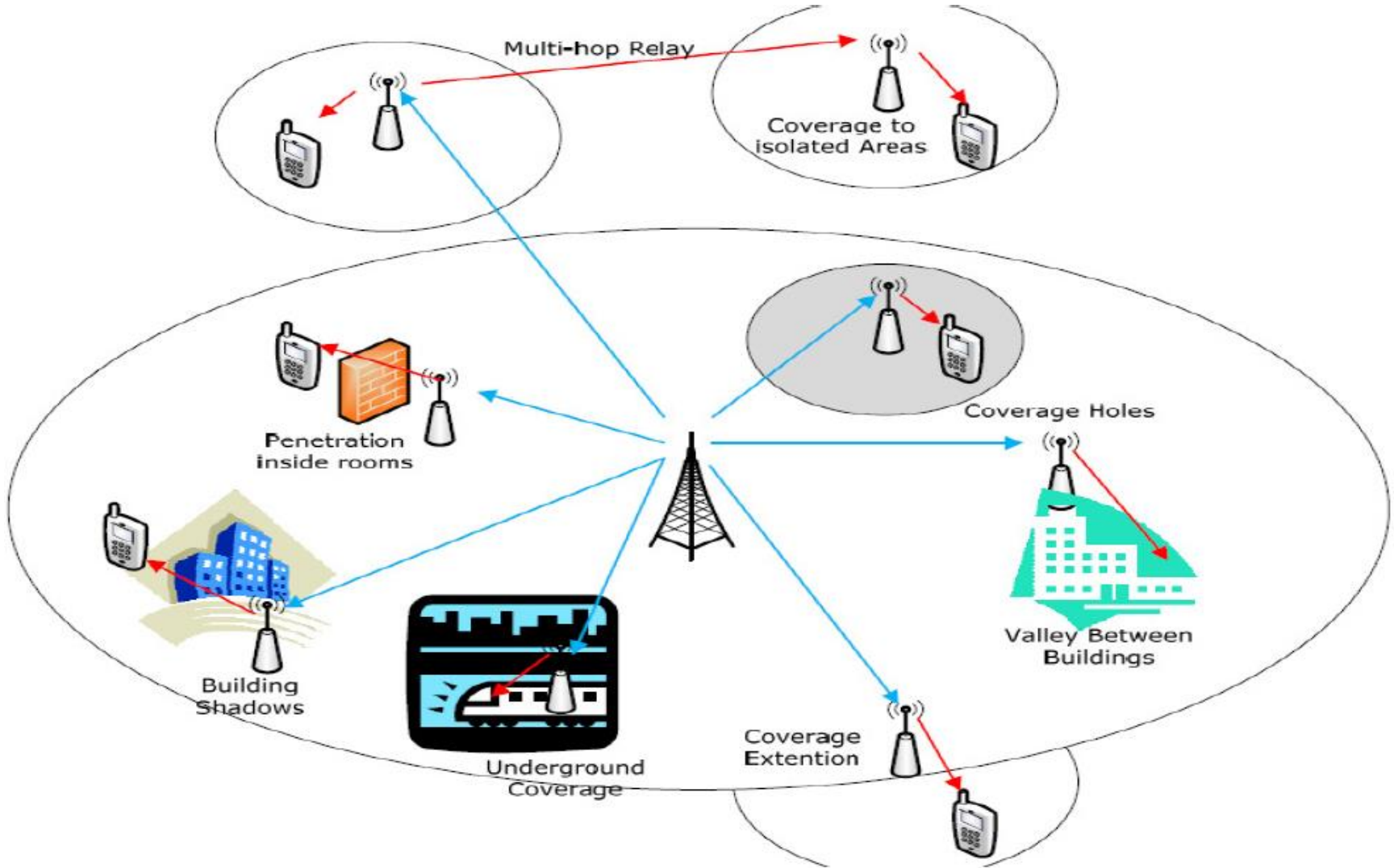

LTE-A main features

Support of Wider Bandwidth(Carrier Aggregation)

- Use of multiple component carriers(CC) to extend bandwidth up to 100 MHz
- Common physical layer parameters between component carrier and LTE Rel-8 carrier
- ➔ Improvement of peak data rate, backward compatibility with LTE Rel-8

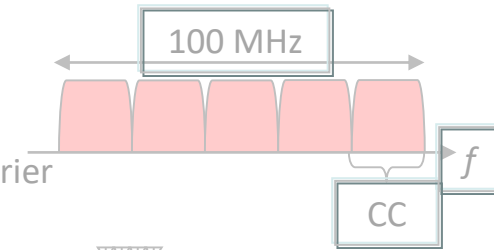

Advanced MIMO techniques

- Extension to up to 8-layer transmission in downlink
- Introduction of single-user MIMO up to 4-layer transmission in uplink
- Enhancements of multi-user MIMO
- ➔ Improvement of peak data rate and capacity

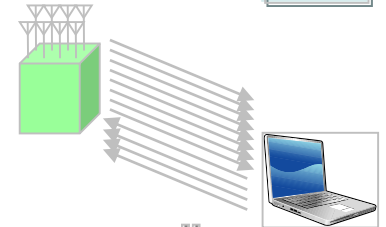

Heterogeneous network and eICIC (enhanced Inter-Cell Interference Coordination)

- Interference coordination for overlaid deployment of cells with different Tx power
- ➔ Improvement of cell-edge throughput and coverage

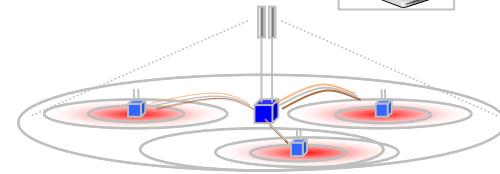

Relay

- Supports radio backhaul and creates a separate cell and appear as Rel. 8 LTE eNB to Rel. 8 LTE UEs
- ➔ Improvement of coverage and flexibility of service area extension



Coordinated Multi-Point transmission and reception (CoMP)

- Support of **multi-cell transmission and reception**
- ➔ **Improvement of cell-edge throughput and coverage**

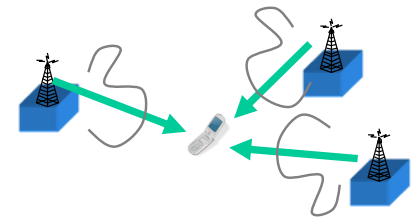

Co-ordinated Multipoint

■ CoMP

- Stands for Coordinated Multipoint Transmission and Reception
- Generally known as distributed MIMO or network MIMO

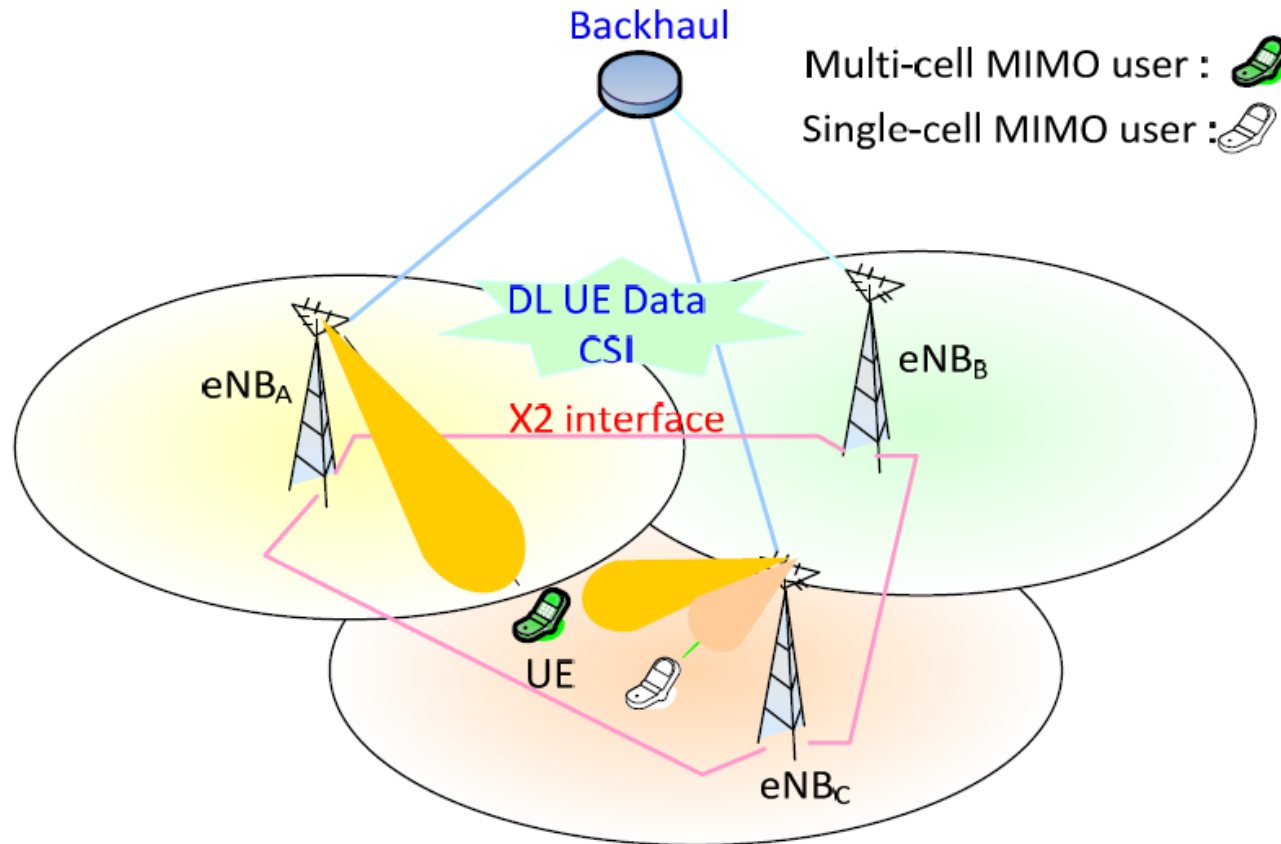

Co-ordinated Multipoint

(a) Coordinated beamforming/Coordinated scheduling

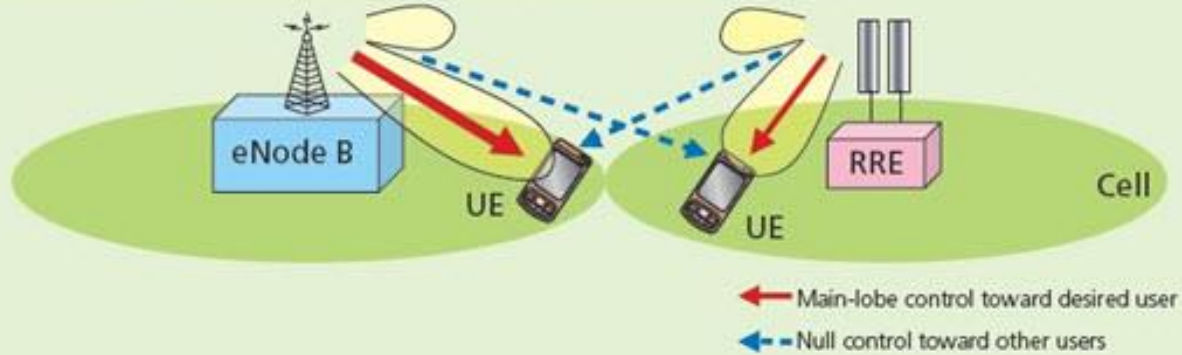

(b) Joint processing



(b-1) Joint transmission



(b-2) Dynamic cell selection

CoMP – Coordinated scheduling

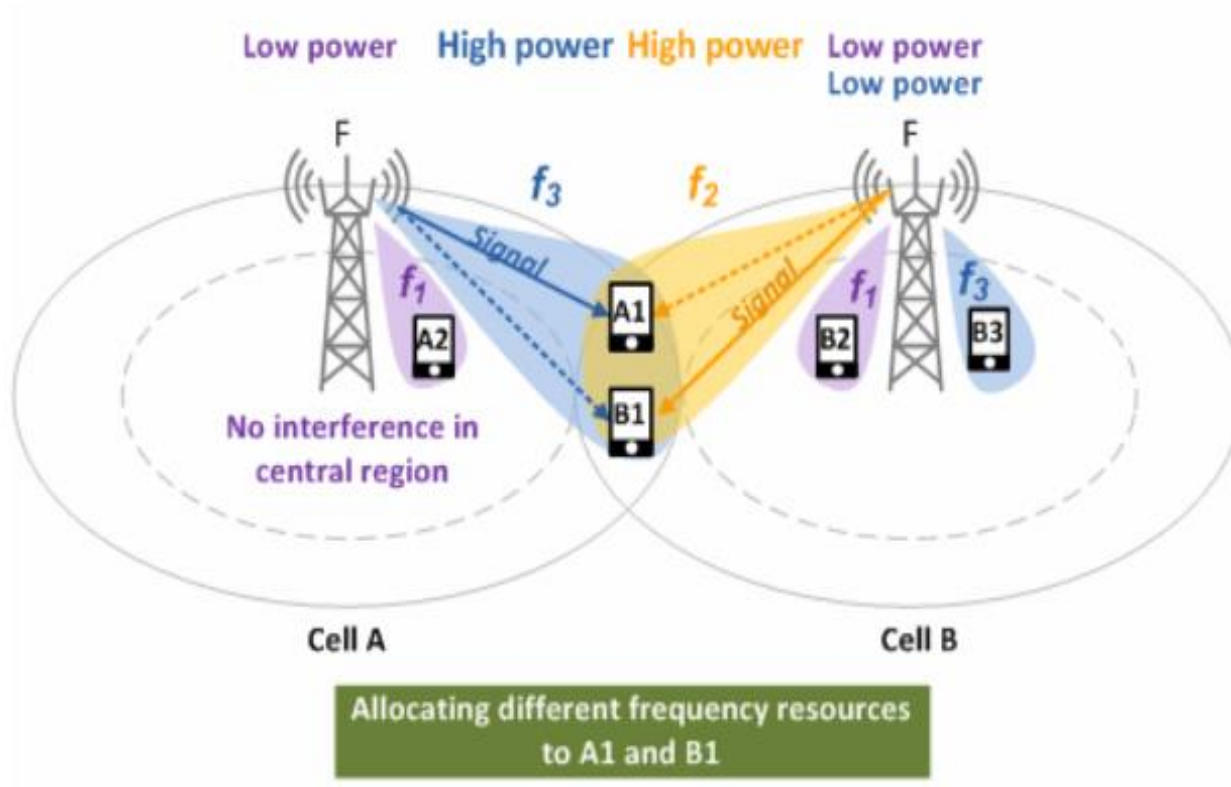

- Cell A and Cell B cooperate with each other to allocate different frequency resources (f_3, f_2) to A1 and B1 at cell edge, avoiding interference.
- A1 and B1 receive data, only from their respective serving cells, Cell A and Cell B.

$$F = \{f_1, f_2, \dots, f_N\}$$

f_i : RBs or sub-carriers

RB: Resource Block

CoMP – Joint transmission

- Multiple eNBs transmit to one UE using UE-specific reference signals:

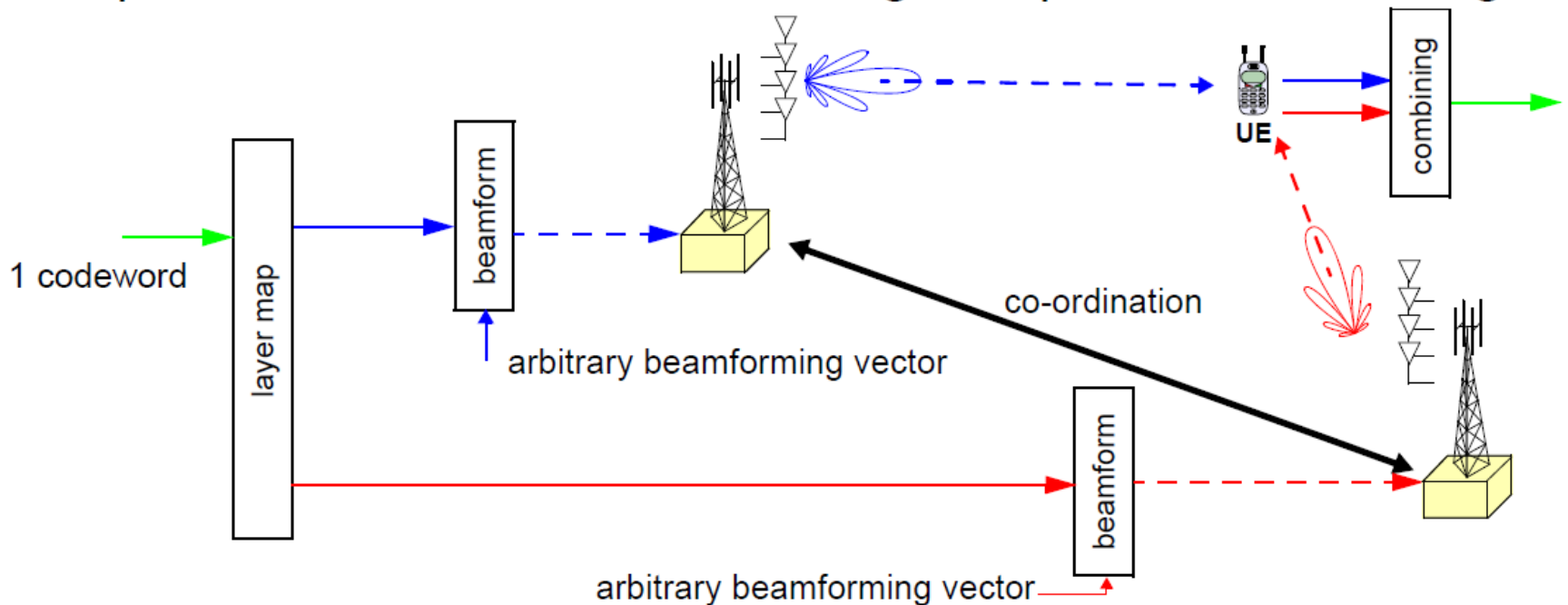

- eNB selection per transmission (UE connected to multiple eNB).

CoMP – Dynamic cell selection

- Data only available at one eNB;
- eNBs jointly decide scheduling of transmission in time, frequency and space:

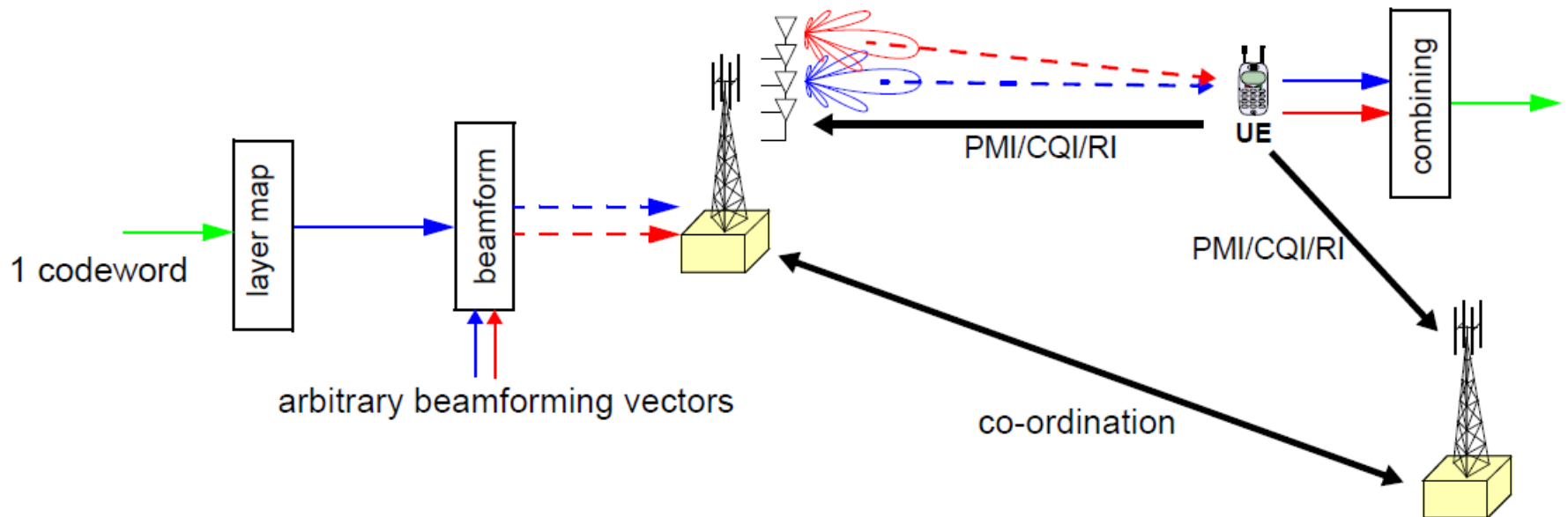

Example of CoMP

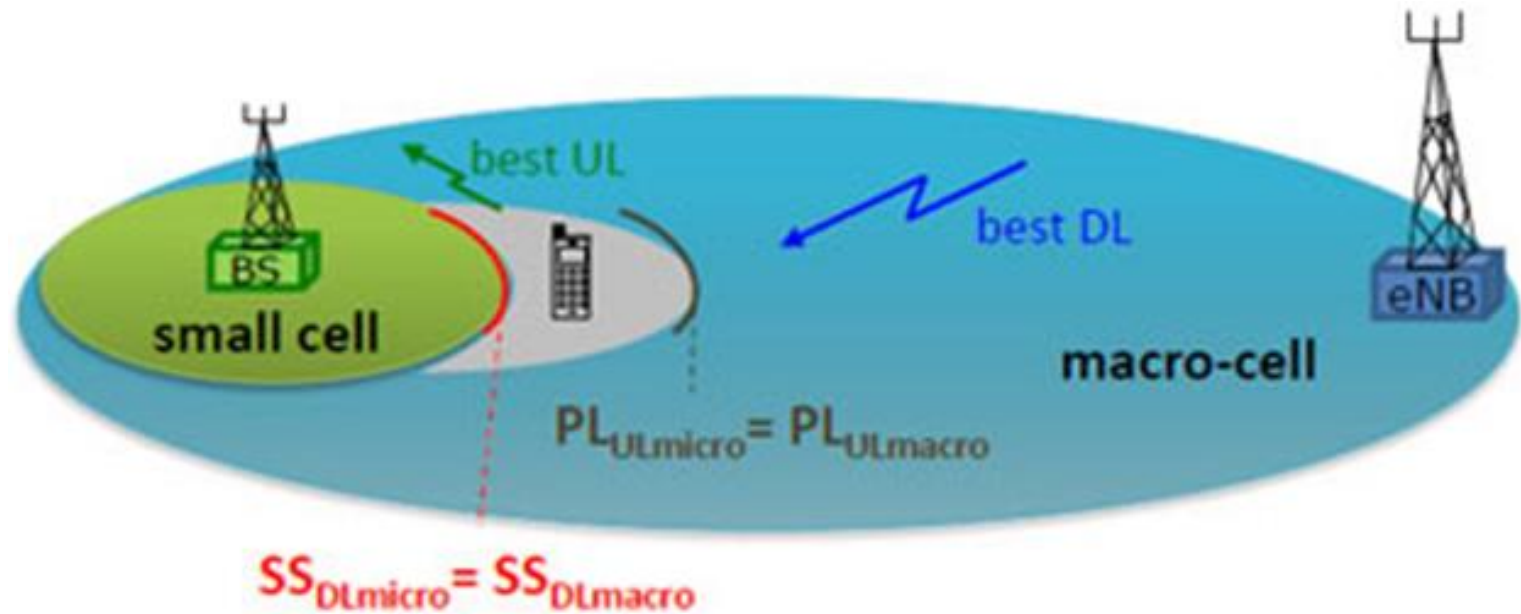

- Using CoMP it is possible for the UE in the grey area to have both the best DL from the macro-eNB and the best UL to the base station of the the small cell

Example of DL CoMP

a) Joint Transmission

Data is transmitted – in the same frequency and at the same time - from multiple TX-points , here two

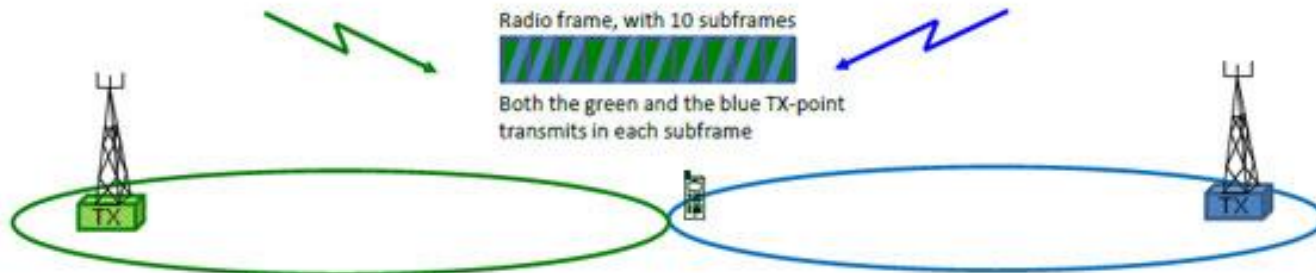

b) Dynamic Point Selection

Data is transmitted from one TX-point at the time.

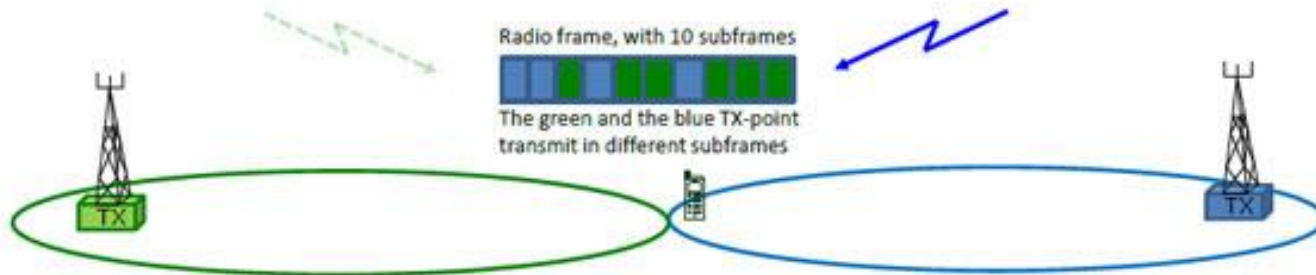

a) Joint Transmission: two TX-points transmit to one UE in the same radio resource

b) Dynamic Point Selection: two TX points are ready to transmit, but only one will be scheduled in each subframe

LTE-Advanced Improvements

- A schematic view on LTE-Advanced improvements

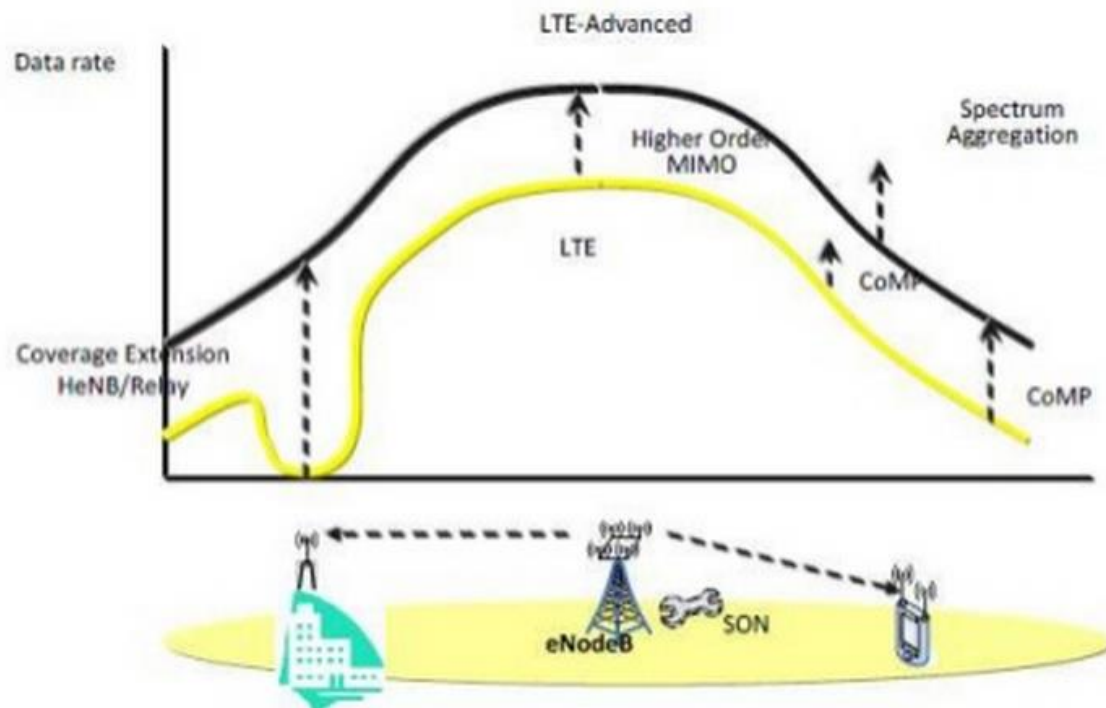

LTE Advanced: part of a rich roadmap of LTE technologies

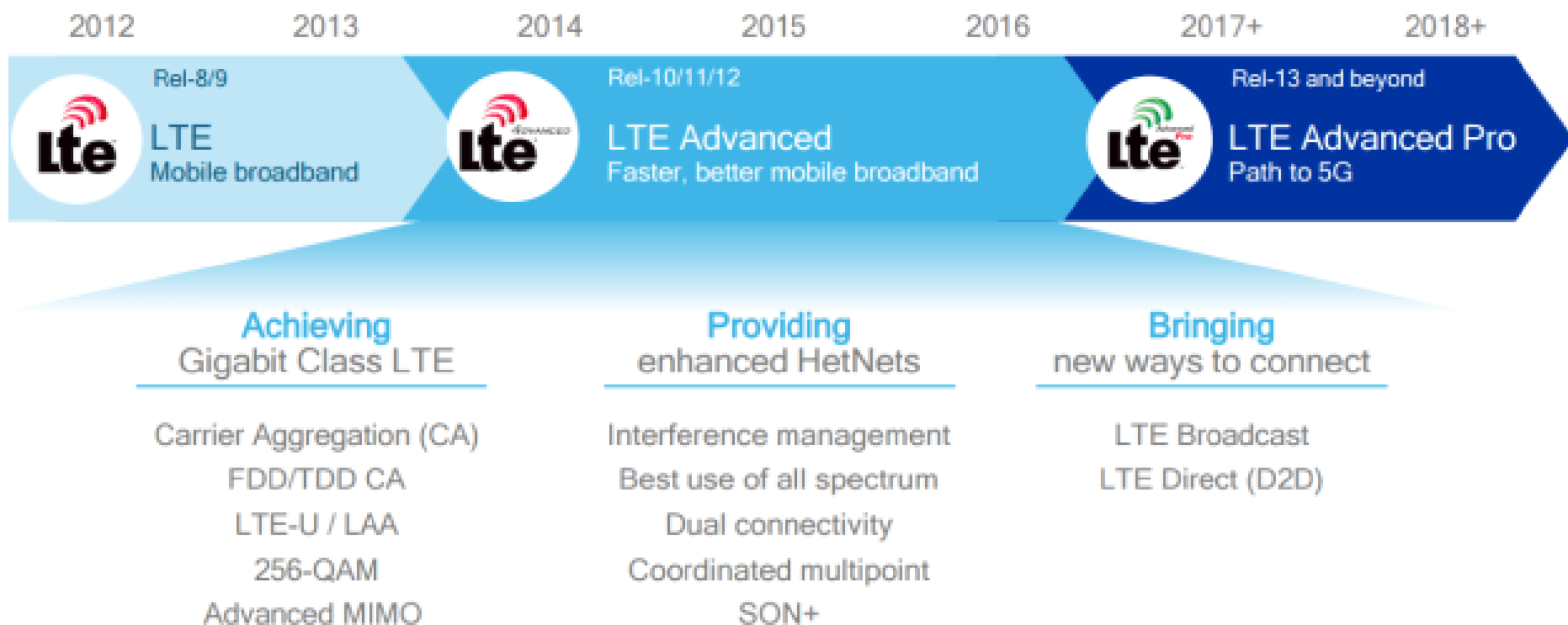

3GPP Releases

- ❑ **Rel. 8-9**: LTE
- ❑ **Rel. 10-12**: LTE-Advanced (4G)
- ❑ **Rel. 13-14**: LTE Advanced-Pro (**4.5G**)
- ❑ **Rel. 15-16**: LTE NR (5G)

Release 13 Features

1. Active Antenna Systems (AAS)
2. Self-Organizing Networks (SON)
3. Elevation Beamforming
4. Inter-eNB CoMP
5. Indoor Positioning
6. Carrier Aggregation Enhancements
7. License Assisted Access (LAA)
8. LTE-WLAN Aggregation Enhancements
9. Wi-Fi with IP Flow Mobility
10. RAN Sharing
11. Enhanced D2D Proximity Services (PROSE)
12. Dual Connectivity Enhancements
13. MTC Enhancements
14. Single-Cell Point-to-Multipoint (SC-PTM)

Release 14 Features

1. Enhance Narrowband IoT (eNB-IoT)
2. Enhanced Machine Type Communications (eMTC)
3. Enhanced LWIP (eLWIP)
4. Enhanced LTE-WLAN Aggregation (eLWA)
5. Enhanced License Assisted Access (eLAA)
6. Enhanced Full-Dimension (eFD) MIMO
7. Enhanced Multimedia Broadcast Multicast Service (eMBMS)
8. Multiuser Superposition Transmission (MUST)
9. Layer 2 (L2) Latency Reduction
10. **Vehicle to Vehicle (V2X) Based on Sidelink**
11. Uplink (UL) Capacity Enhancements
12. Light Connection

5G specifications

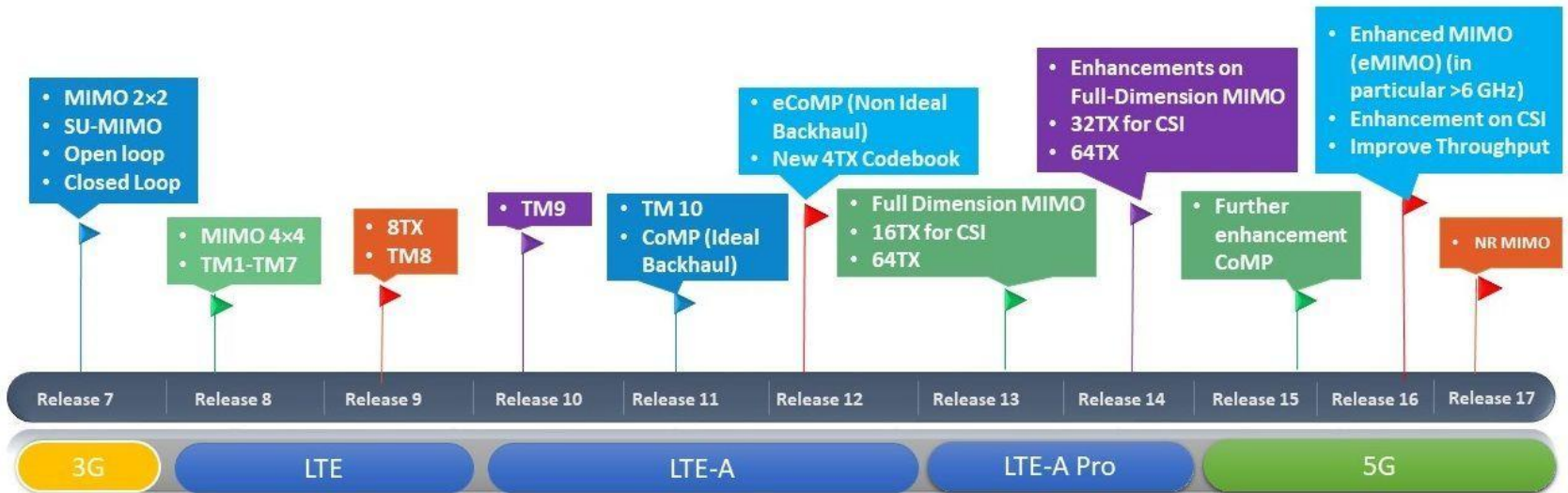

Inter-eNB CoMP

- ❑ Coordinated Multipoint Operation (CoMP) in Release 11 was restricted to eNBs connected via ideal backhaul
 - No need for network interfaces
- ❑ In Release 12, a signaling interface has been added which allows eNBs to interchange measurement and resource allocation information
- ❑ In Release 13, new signaling elements were added

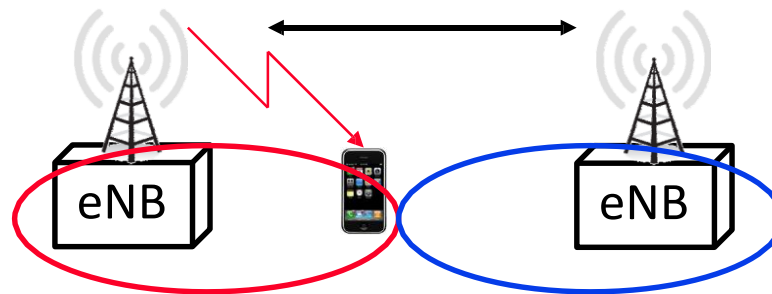

Indoor Positioning

- ❑ Position can be determined by:
 - ❑ Barometric sensors
 - ❑ Wireless LANs
 - ❑ Bluetooth beacons
 - ❑ Terrestrial beacon system broadcasting signals for positioning, e.g., Metropolitan Beacon Systems (MBS)
- ❑ R13 supports only standalone mode without network assistance
- ❑ R14 introduced advanced techniques

Carrier Aggregation Enhancements

- CA was introduced in R10
- R12 limited to 5 carriers -> 100 MHz
- R13 extended to 32 carriers -> 640 MHz
 - Inter-band and Intra-band
 - Licensed and Unlicensed

RAN Sharing

- Multiple operators can share a radio access network (RAN)
- Owner operator can put limits on total UL/DL load of sharing
- QoS profile can also be limited as agreed

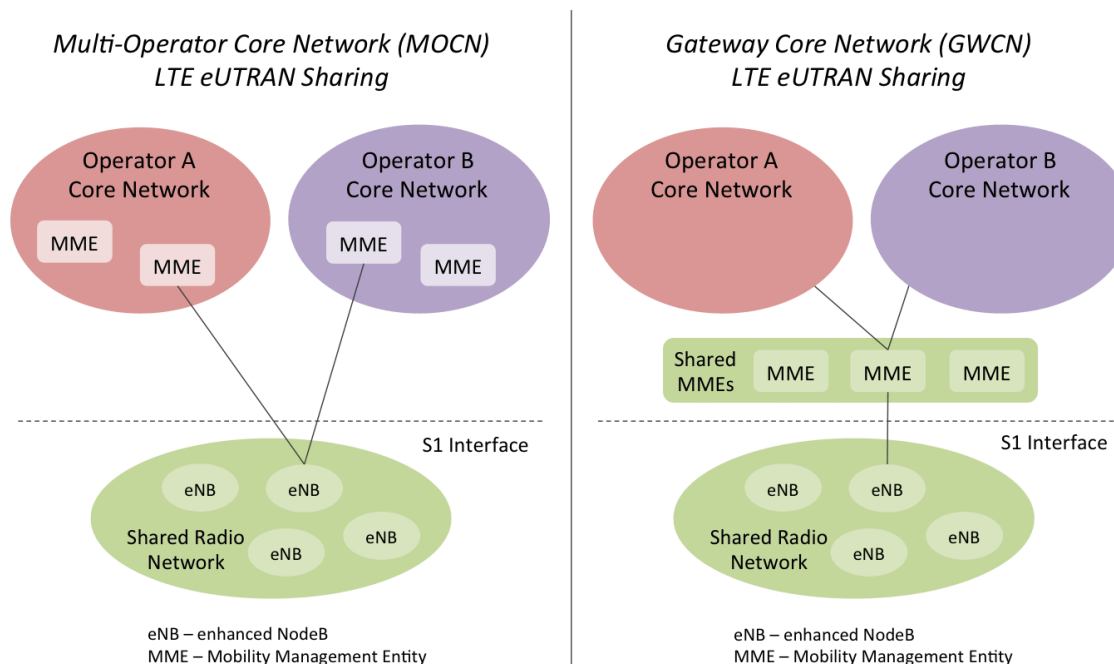

Enhanced D2D Proximity Services (PROSE)

- ❑ Device-to-Device (D2D) was introduced in R12
- ❑ In R13:
 - ❑ UEs can search multiple networks for “side-link”
 - ❑ Support for relaying using D2D
 - ❑ Out-of-coverage D2D discovery

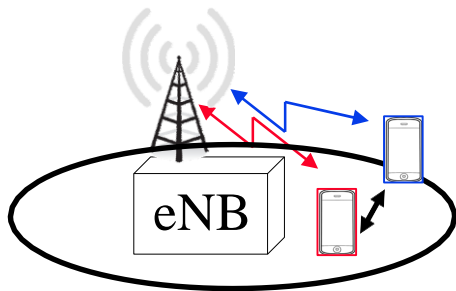

(a)

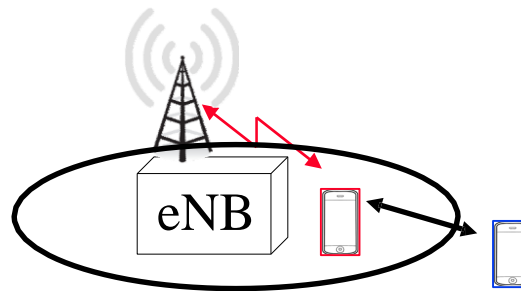

(b)

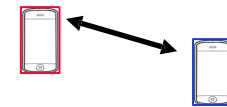

(c)

Cellular Vehicle-to-X (C-V2X)

- ❑ Vehicle-to-Vehicle (V2V): Collision avoidance
- ❑ Vehicle-to-Infrastructure (V2I): Traffic lights
- ❑ Vehicle-to-Pedestrians (V2P): Safety alerts
- ❑ Vehicle-to-Network (V2N): Maps, routing
- ❑ Use 5.9 GHz VANET spectrum for V2I, V2P, V2V
- ❑ Use licensed spectrum for V2N

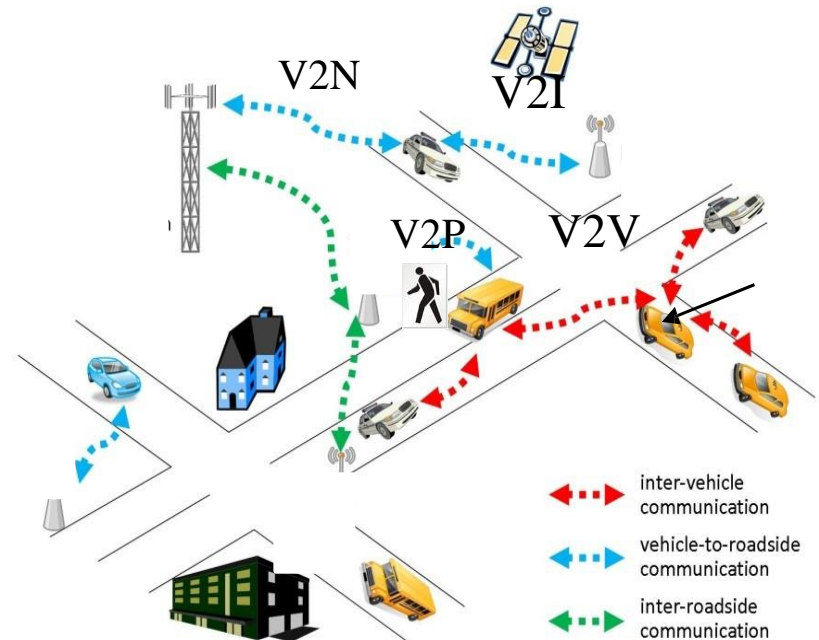

D2D vs. V2V

| | D2D | V2V |
|--------------------|-------------------|-------------------------|
| Application | Voice | M2M |
| Packet Size | Small | Large |
| Latency | Not Critical | Critical 20-100 ms |
| UE Density | Low number | High number of vehicles |
| Dynamics | Pedestrian speeds | 250 km/h |