

Long Term Evolution (LTE)
Long Term Evolution – Advanced (LTE-A)

IMT-Advanced

Item	IMT-Advanced
Peak Data Rate (DL)	1 Gbps
Peak Data Rate (UL)	500 Mbps
Spectrum Allocation	>40 MHz
Latency (User Plane)	10 ms
Latency (Control Plane)	100 ms
Peak Spectral Efficiency (DL)	15 bps/Hz (4 X 4)
Peak Spectral Efficiency (UL)	6.75 bps/Hz (2 X 4)
Average Spectral Efficiency (DL)	2.2 bps/Hz (4 X 2)
Average Spectral Efficiency (UL)	1.4 bps/Hz (2 X 4)
Cell-Edge Spectral Efficiency (DL)	0.06 bps/Hz (4 X 2)
Cell-Edge Spectral Efficiency (UL)	0.03 bps/Hz (2 X 4)
Mobility	Up to 350 km/h

Motivation for LTE

- Need for higher data rates and greater spectral efficiency
 - Can be achieved with HSDPA/HSUPA
 - and/or new air interface defined by 3GPP LTE
- Need for Packet Switched optimized system
 - Evolve UMTS towards packet only system
- Need for high quality of services
 - Use of licensed frequencies to guarantee quality of services
 - Always-on experience (reduce control plane latency significantly)
 - Reduce round trip delay
- Need for cheaper infrastructure
 - Simplify architecture, reduce number of network elements

Advantages of LTE

- ▶ High network throughput
- ▶ Low latency
- ▶ Plug & Play architecture
- ▶ Low Operating Costs
- ▶ All-IP network
- ▶ Simplified upgrade path from 3G networks

for Network Operators

- ▶ Faster data downloads/uploads
- ▶ Improved response for applications
- ▶ Improved end-user experience

for End Users

Mobile Network Evolution

1G	2G	3G	4G
AMPS, NMT TACS	GSM/GPRS/ EDGE cdmaOne	WCDMA/HSPA+ CDMA2000/EVDO TD-SCDMA	LTE LTE-A



analog
voice



Digital voice
+ Simple data



Mobile
broadband



Mobile Internet
More & faster



Network Architecture Evolution

2G

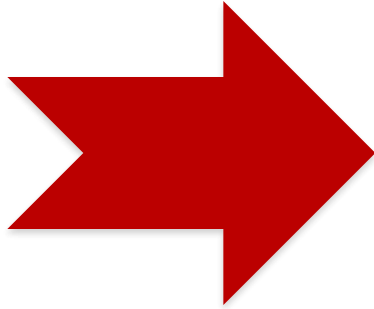

3G

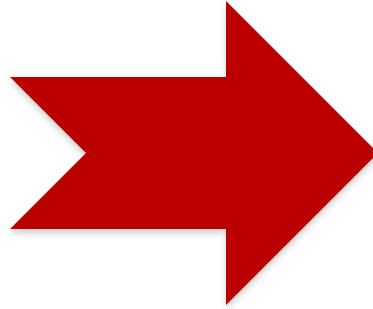

4G

- Circuit-switching for voice

- Circuit-switching for voice
- Packet-switching for data

- Packet-switching for everything
- IP-based

Telecomm Infrastructure

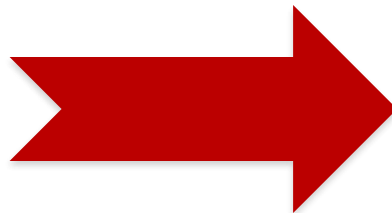

IP-based Internet

CS Signaling

- used to setup, maintain teardown VC
- used in 2G, as well as in 3G
- not used in today's Internet

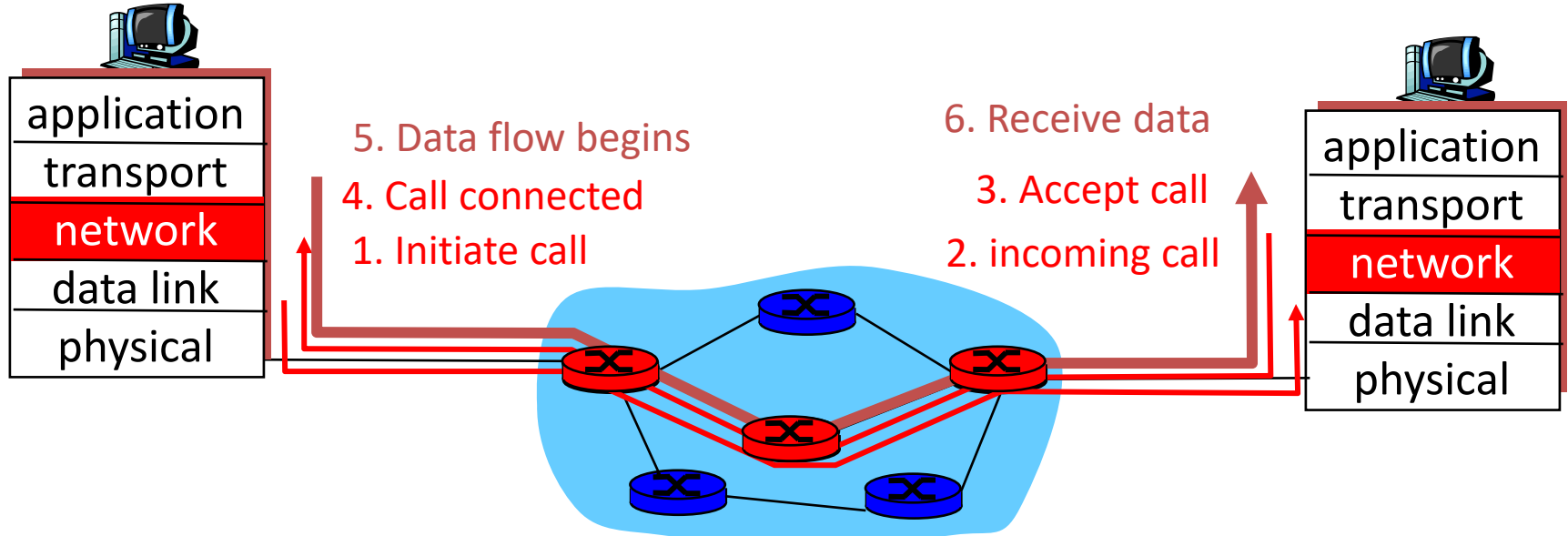

Packet Switching (PS)

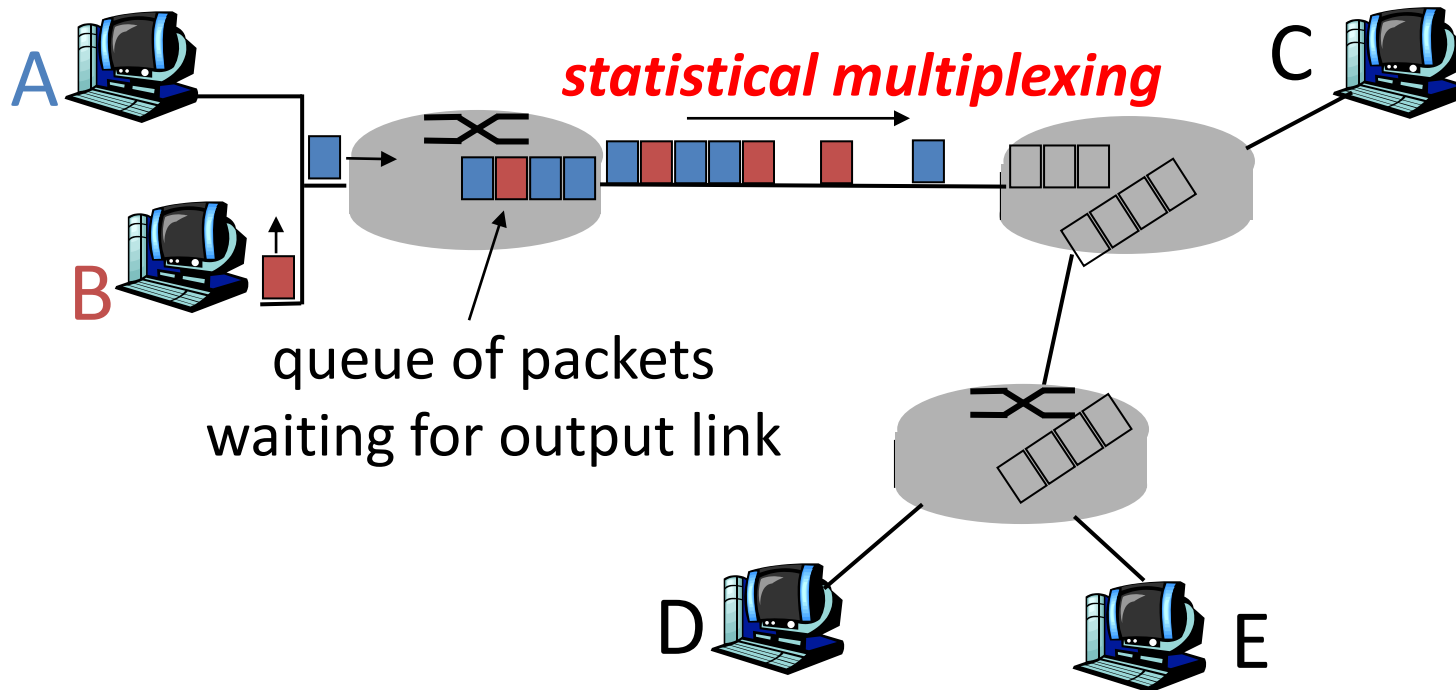

- Sequence of A & B packets does not have fixed pattern, bandwidth shared on demand → statistical multiplexing
- Store-and-forward at intermediate routers
- Used by the Internet

Comparison of LTE Speed

2G – 4G Data download rates

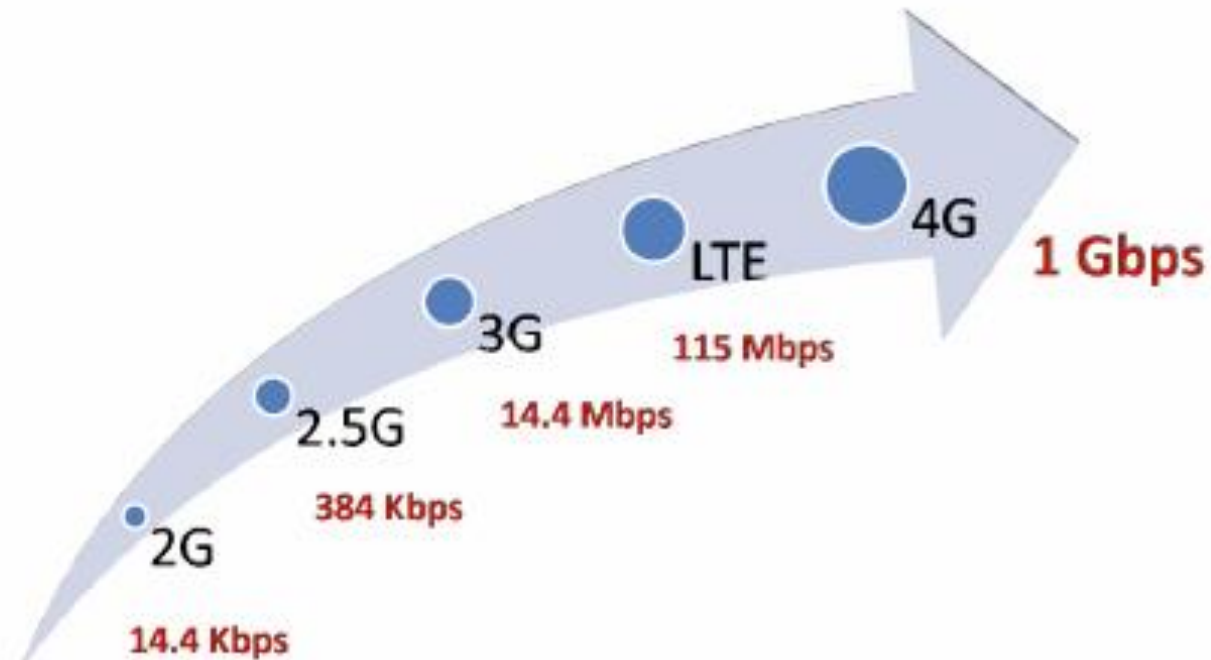

- 2.5G speed is based on the maximum offered by EDGE
- 3G speed is based on the maximum offered by HSDPA

LTE Evolution

- Specification managed by 3GPP organization
 - 3rd Generation Partnership Project
 - UMTS (Universal Mobile Telephone System) Rel 99
 - HSDPA (High Speed Downlink Packet Access) Rel 5
 - HSUPA (High Speed Uplink Packet Access) Rel 6
 - HSPA+ Rel 7, enhancements in Rel 8-10
- New LTE specification in Release 8-9
- LTE-A in Release 10

Release of 3GPP specifications

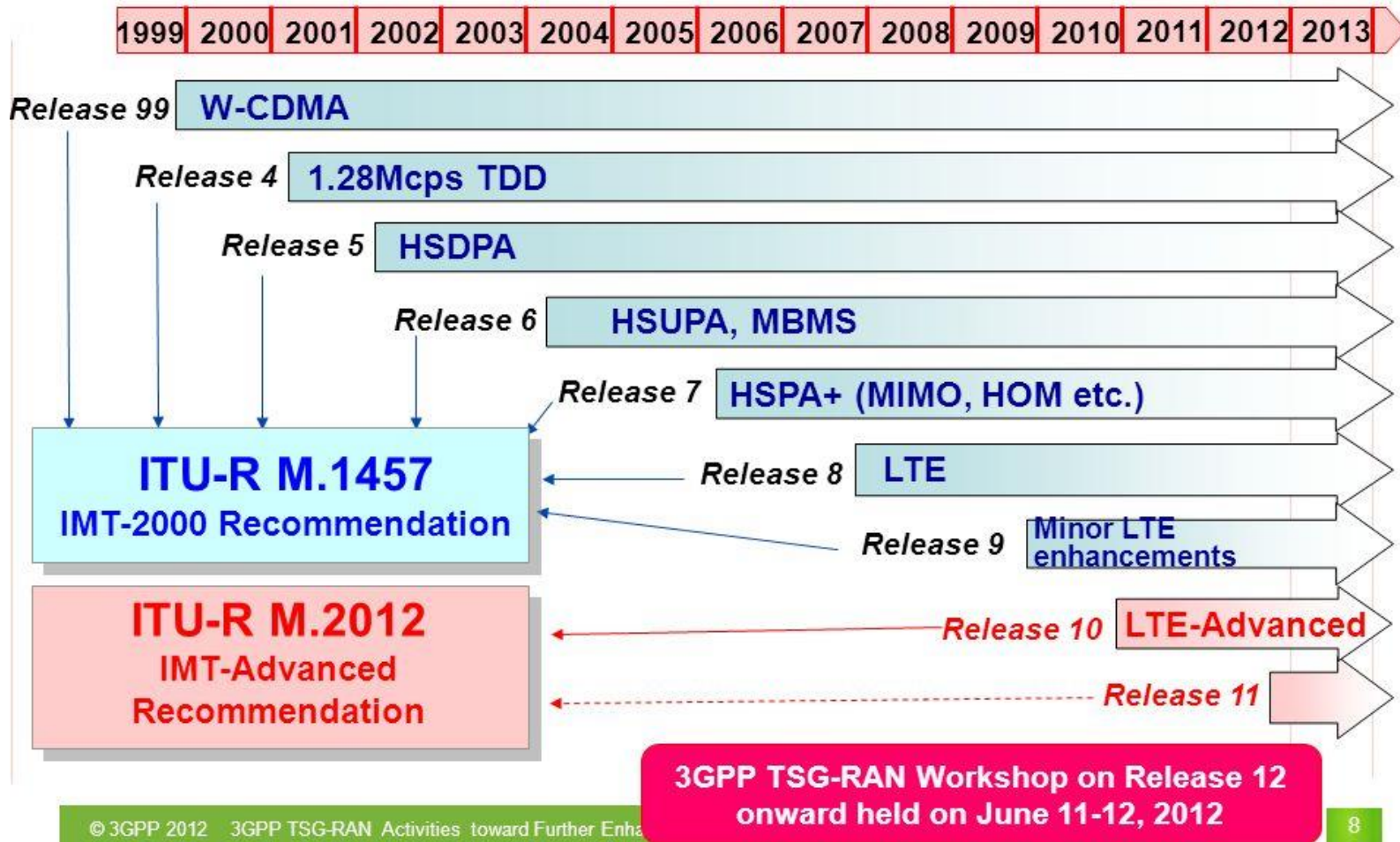

	WCDMA (UMTS)	HSPA HSDPA / HSUPA	HSPA+	LTE	LTE ADVANCED (IMT ADVANCED)
Max downlink speed (bps)	384k	14 M	28 M	100 M	1 G
Max uplink speed (bps)	128 k	5.7 M	11 M	50 M	500 M
Latency round trip time (approx.)	150 ms	100 ms	50 ms (max)	~10 ms	Less than 5 ms
3GPP releases	Rel 99/4	Rel 5/6	Rel 7	Rel 8/9	Rel 10
Approx years of initial roll out	2003/4	2005/6 HSDPA 2007/8 HSUPA	2008/9	2009/10	
Access methodology	CDMA	CDMA	CDMA	OFDMA/SC-FDMA	OFDMA/SC-FDMA

LTE performance requirements

- Data Rate:
 - Instantaneous downlink peak data rate of 100Mbit/s in a 20MHz downlink spectrum (i.e. 5 bit/s/Hz)
 - Instantaneous uplink peak data rate of 50Mbit/s in a 20MHz uplink spectrum (i.e. 2.5 bit/s/Hz)
- Cell range
 - 5 km - optimal size
 - 30km sizes with reasonable performance
 - up to 100 km cell sizes supported with acceptable performance
- Cell capacity
 - up to 200 active users per cell(5 MHz) (i.e., 200 active data clients)

Key parameters of LTE

Frequency Range	UMTS FDD bands and UMTS TDD bands					
Channel bandwidth 1 Resource Block (RB) =180 kHz	1.4 MHz	3 MHz	5 MHz	10 MHz	15 MHz	20 MHz
	6 RB	15 RB	25 RB	50 RB	75 RB	100 RB
Modulation Schemes	Downlink	QPSK, 16QAM, 64QAM				
	Uplink	QPSK, 16QAM, 64QAM (⇒ optional for handset)				
Multiple Access	Downlink	OFDMA (Orthogonal Frequency Division Multiple Access)				
	Uplink	SC-FDMA (Single Carrier Frequency Division Multiple Access)				
MIMO technology	Downlink	Wide choice of MIMO configuration options for transmit diversity, spatial multiplexing, and cyclic delay diversity (max. 4 antennas at base station and handset)				
	Uplink	Multi-user collaborative MIMO				
Peak Data Rate	Downlink	150 Mbps (UE category 4, 2x2 MIMO, 20 MHz) 300 Mbps (UE category 5, 4x4 MIMO, 20 MHz)				
	Uplink	75 Mbps (20 MHz)				

Multi-tier Architecture

One technology

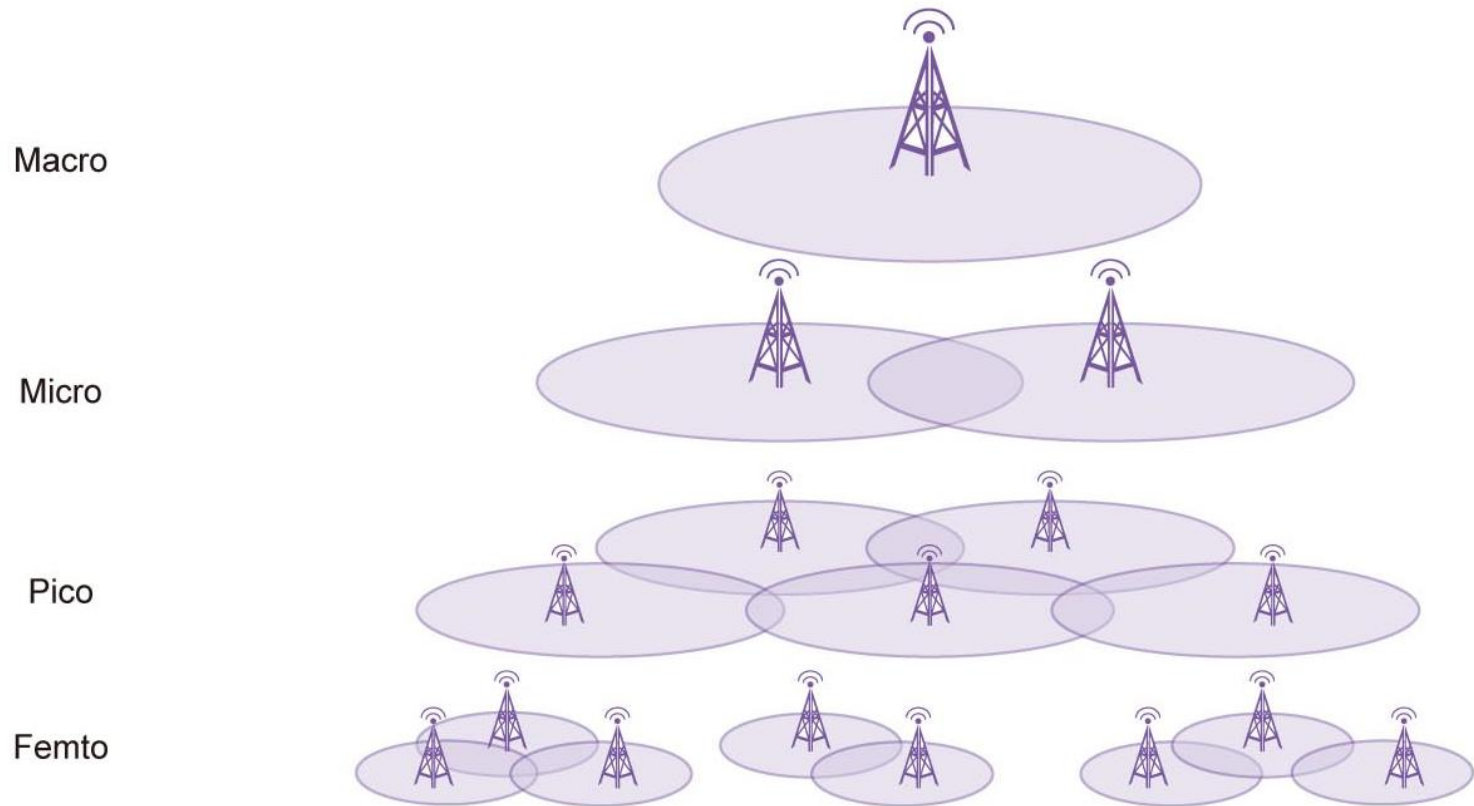

LTE frequency bands



UMTS Architecture

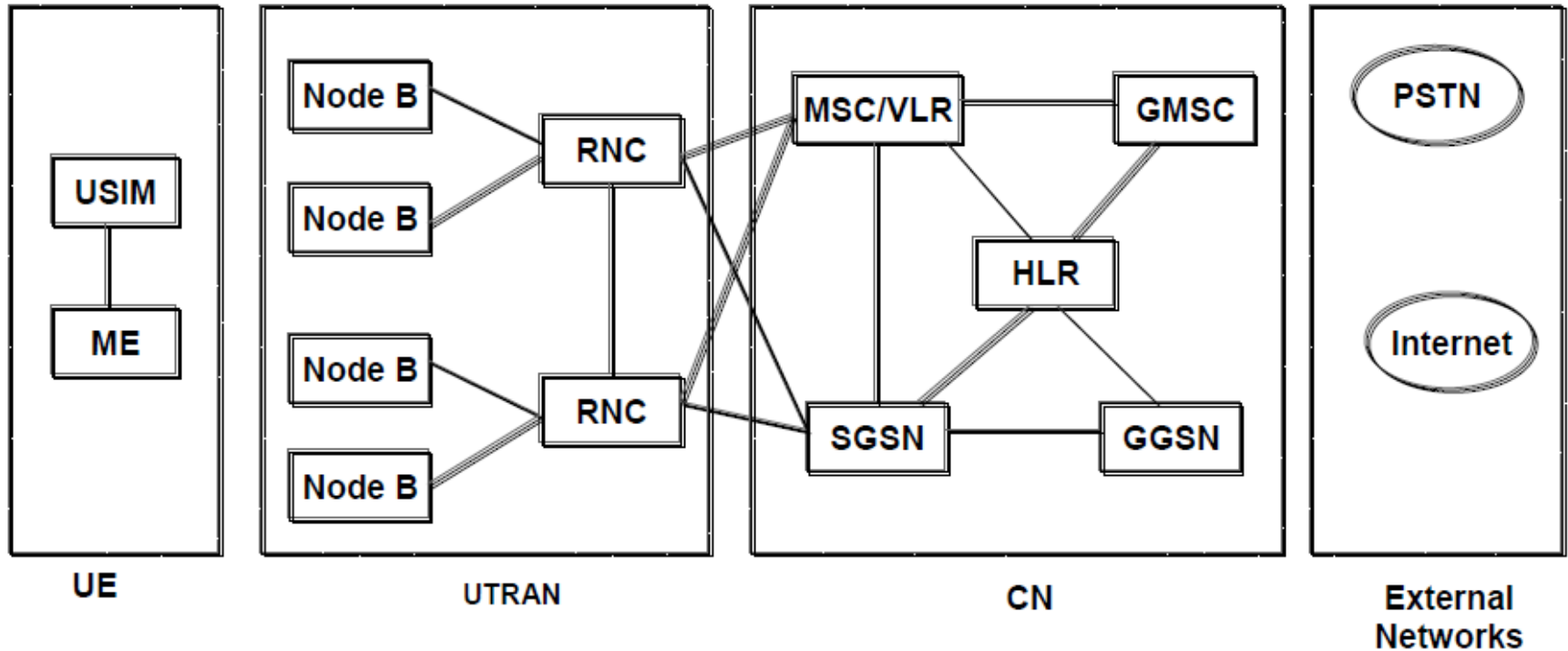

- UE (User Equipment) that interfaces with the user
- UTRAN (UMTS Terrestrial Radio Access Network) handles all radio related functionality – WCDMA is radio interface standard here.
- CN (Core Network) is responsible for transport functions such as switching and routing calls and data, tracking users

LTE Architecture

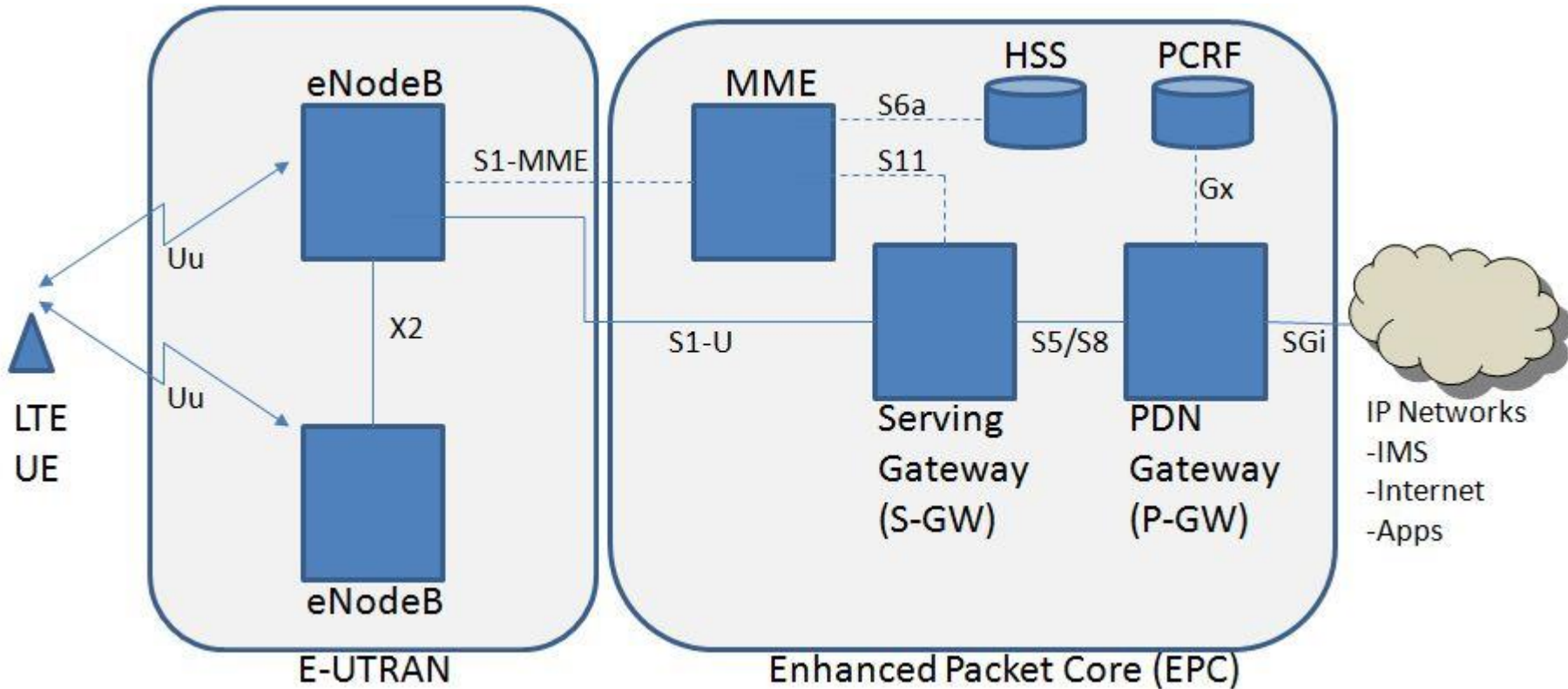

LTE Infrastructure

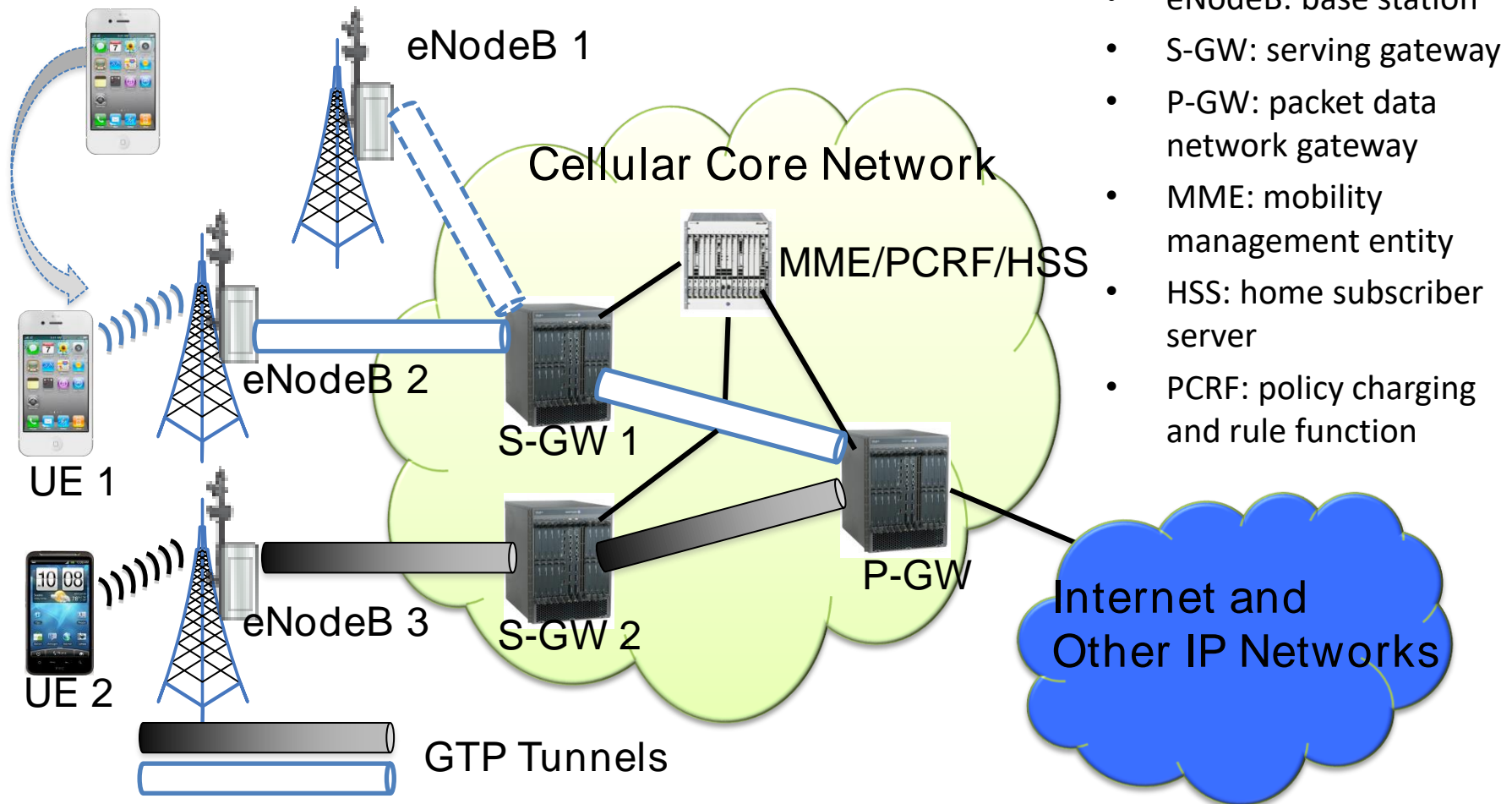

Architectural evolution

EPC = Evolved Packet Core
 MME = Mobility Management Entity
 S-GW = Serving Gateway
 P-GW = PDN Gateway
 PDN = Packet Data Network
 eNodeB = evolved NodeB

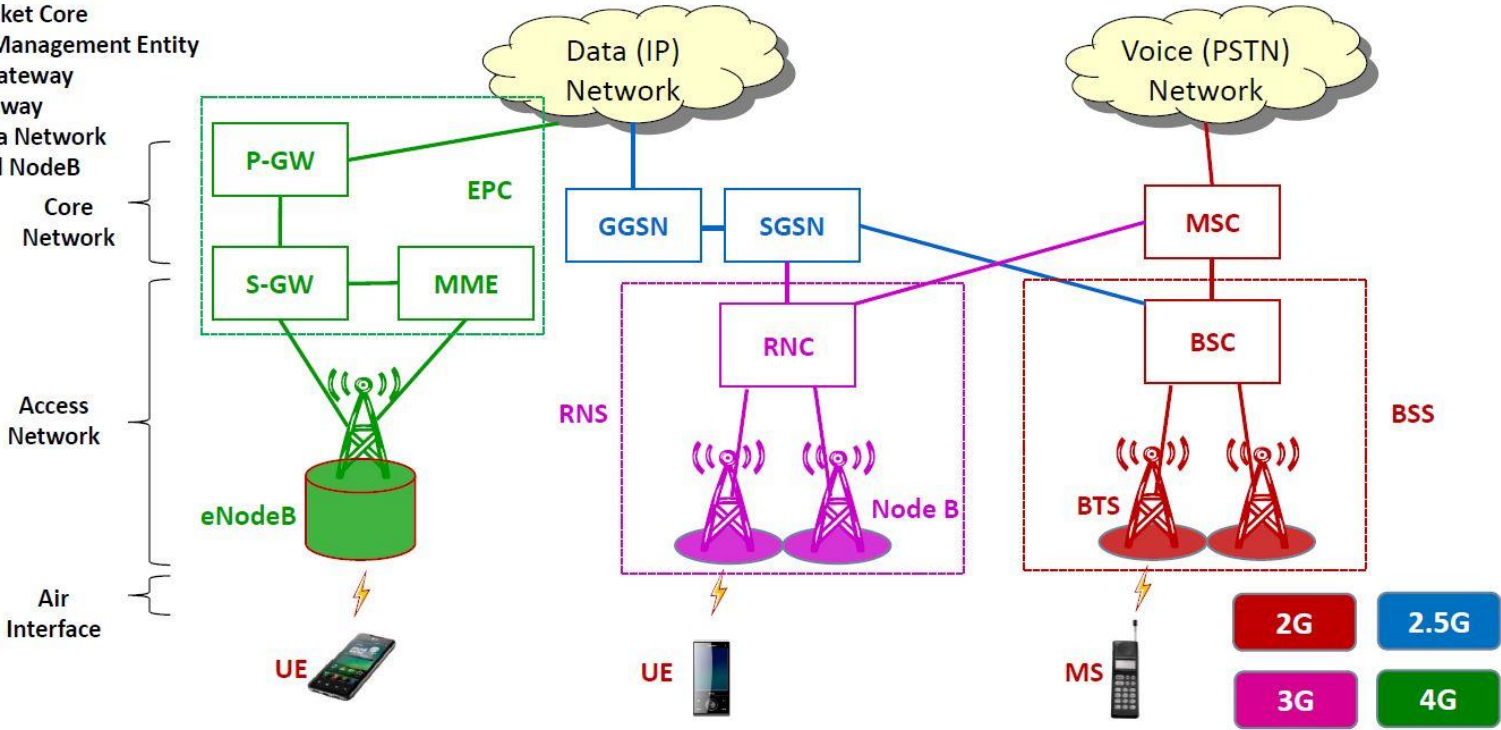

UMTS->LTE Migration

- LTE RAN agreed on the following
 - Packet bearer support
 - Real Time
 - Conversational
 - Reduce the number of the new interfaces
 - NO RNC
 - NO CS-CN
 - Reduce the single point of failure
 - NO RNC
 - Separate the treatment of different types of traffic (O&M, Control and Data) to utilize the BW
 - Reduce the variable delay and Jitter (TCP/IP)
 - Agreed QoS between Transmitting end and receiving end
 - No SHO or Macro diversity
 - MIMO and Tx diversity techniques used

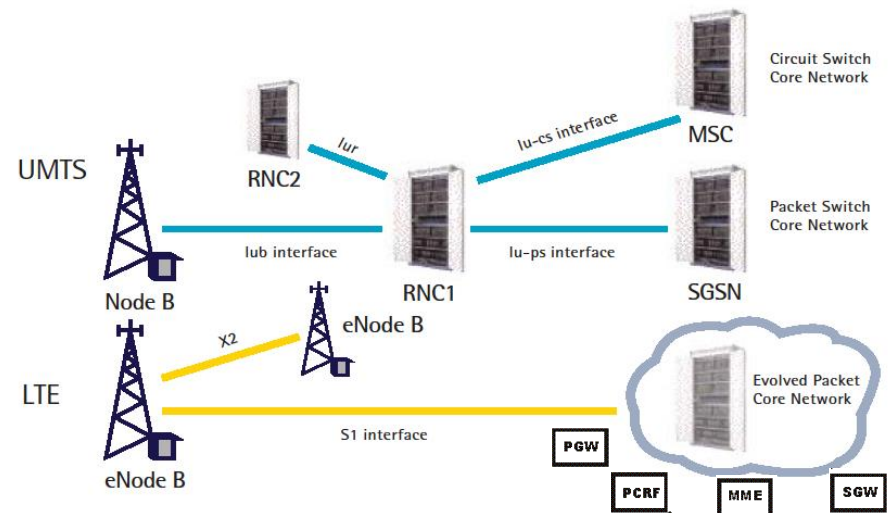

Elements of 4G LTE architecture

Mobile device:

- smartphone, tablet, laptop, IoT, ... with 4G LTE radio
- 64-bit International Mobile Subscriber Identity (IMSI), stored on SIM (Subscriber Identity Module) card
- LTE jargon: User Equipment (UE)

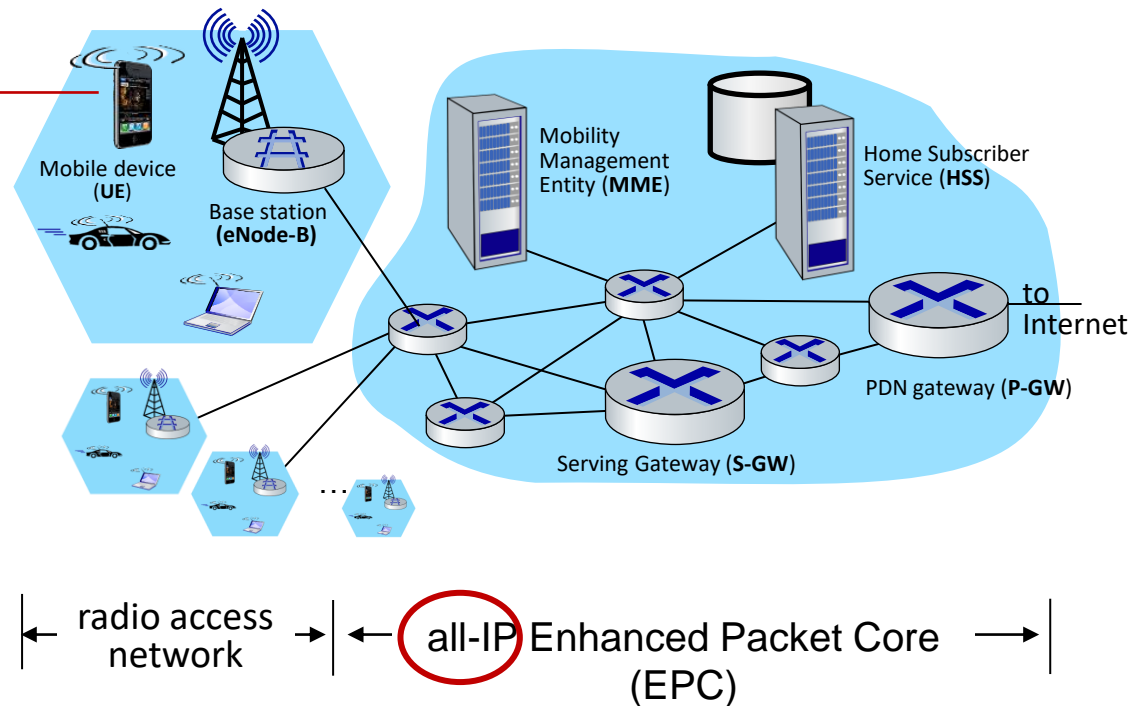

Elements of 4G LTE architecture

Base station:

- at “edge” of carrier’s network
- manages wireless radio resources, mobile devices in its coverage area (“cell”)
- coordinates device authentication with other elements
- similar to WiFi AP but:
 - active role in user mobility
 - coordinates with nearby base stations to optimize radio use
- LTE jargon: eNode-B

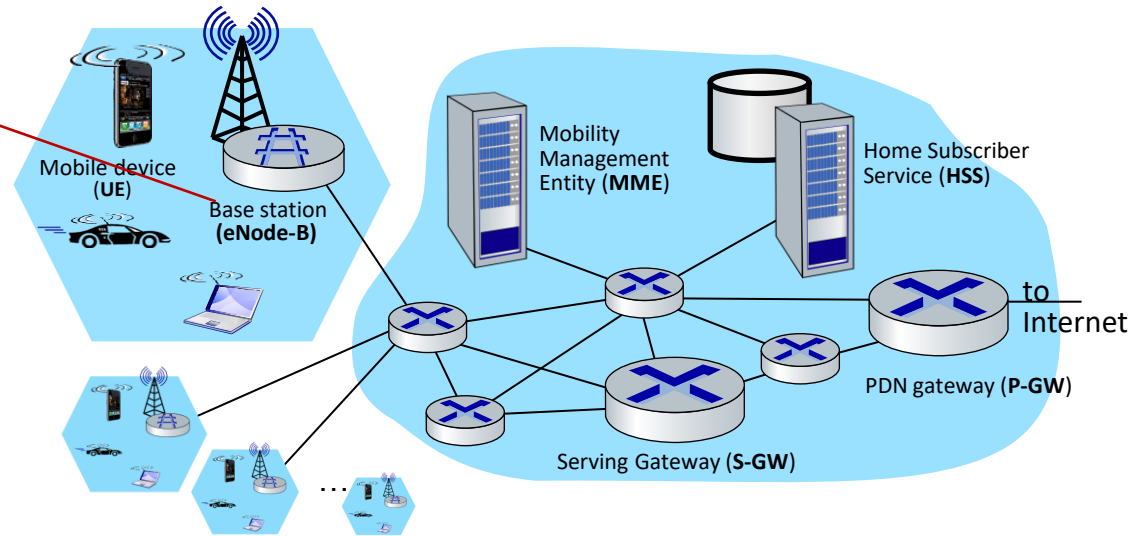

Elements of 4G LTE architecture

Home Subscriber Service

- stores info about mobile devices for which the HSS's network is their "home network"
- works with MME in device authentication

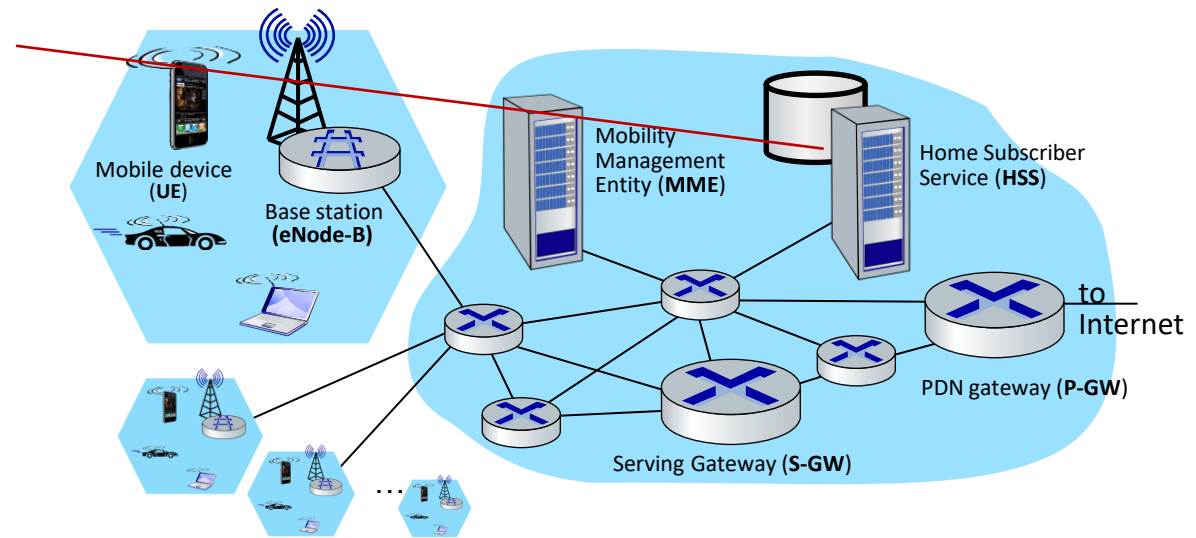

Elements of 4G LTE architecture

Serving Gateway (S-GW), PDN Gateway (P-GW)

- lie on data path from mobile to/from Internet
- P-GW
 - gateway to mobile cellular network
 - Looks like any other internet gateway router
 - provides NAT services
- other routers:
 - extensive use of tunneling

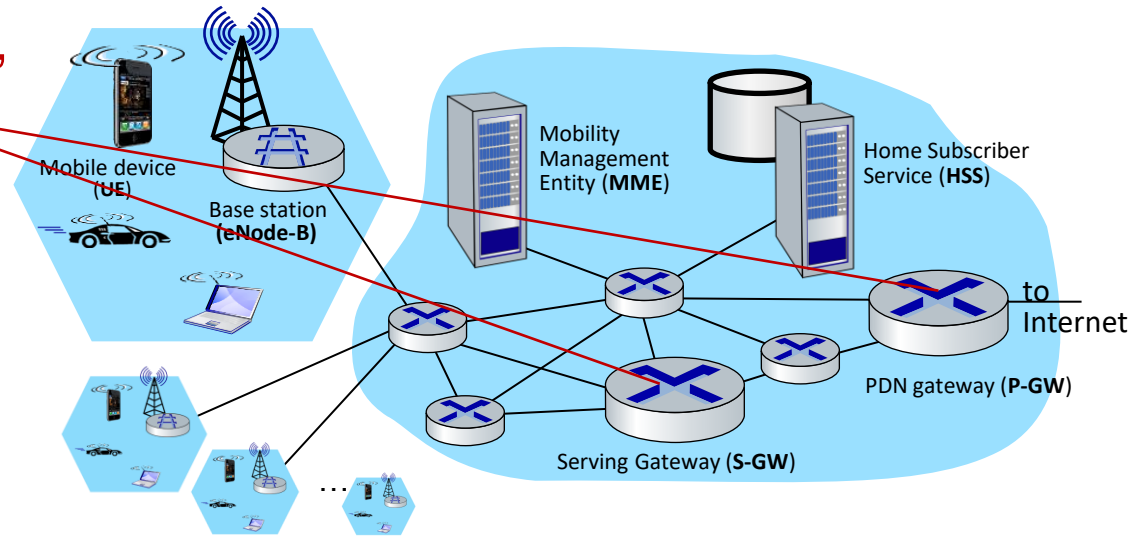

Basic operation of NAT (Network Address Translation)

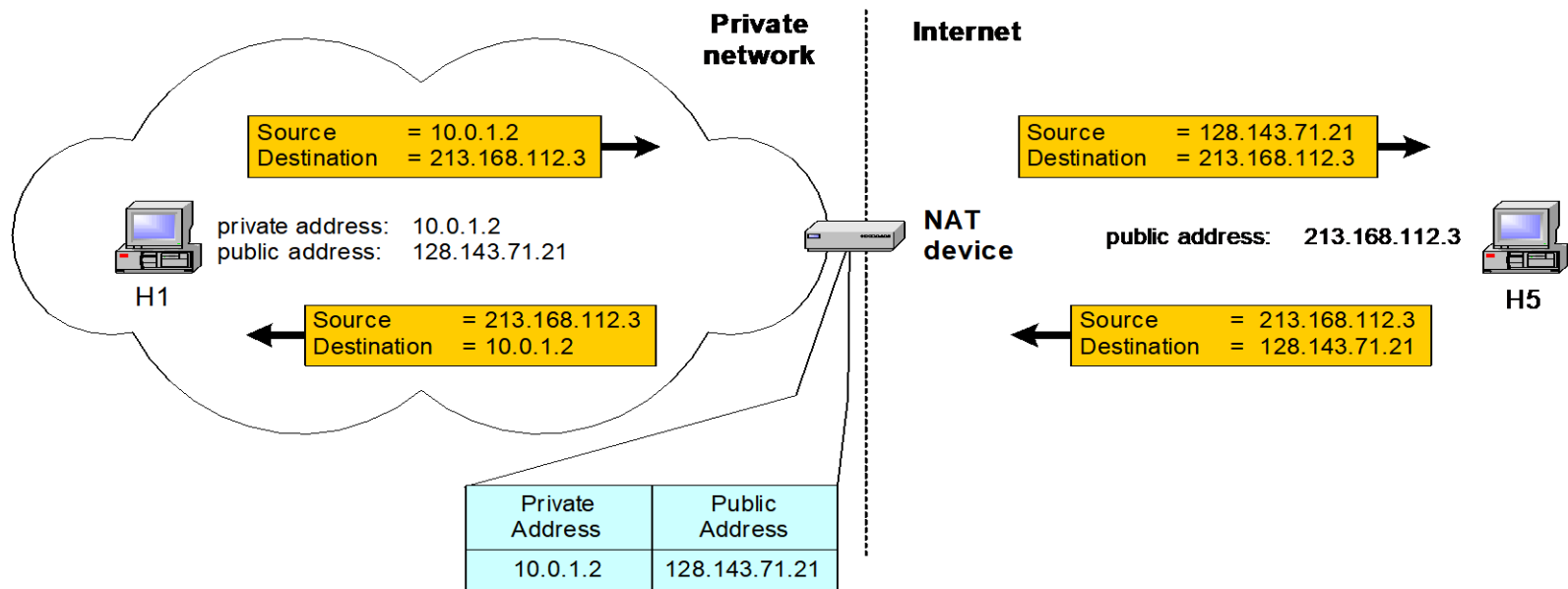

- NAT device has address translation table

Elements of 4G LTE architecture

Mobility Management Entity

- device authentication (device-to-network, network-to-device) coordinated with mobile home network HSS
- mobile device management:
 - device handover between cells
 - tracking/paging device location
- path (tunneling) setup from mobile device to P-GW

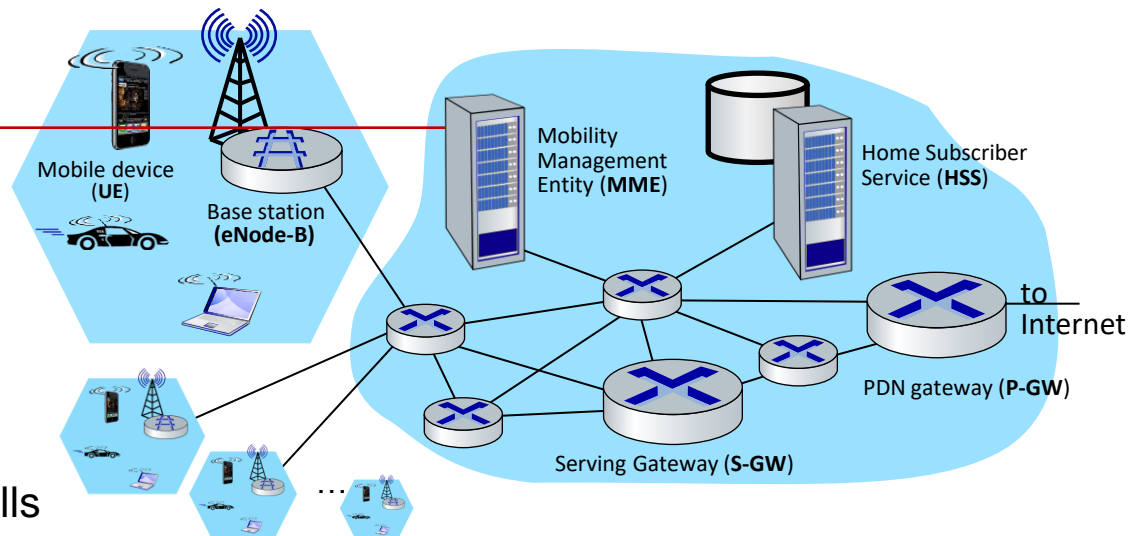

LTE: data plane control plane separation

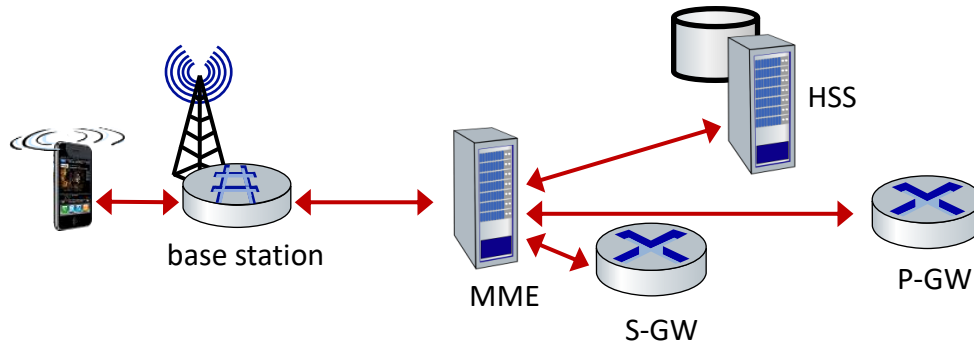

control plane

- new protocols for mobility management, security, authentication

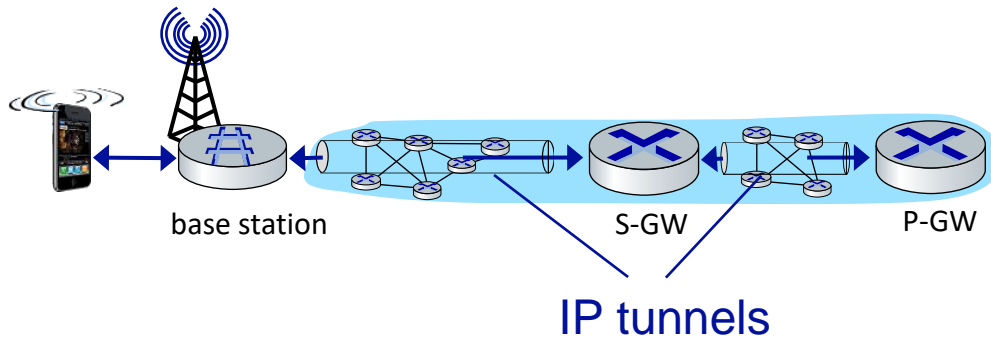

data plane

- new protocols at link, physical layers
- extensive use of tunneling to facilitate mobility

LTE data plane protocol stack: first hop

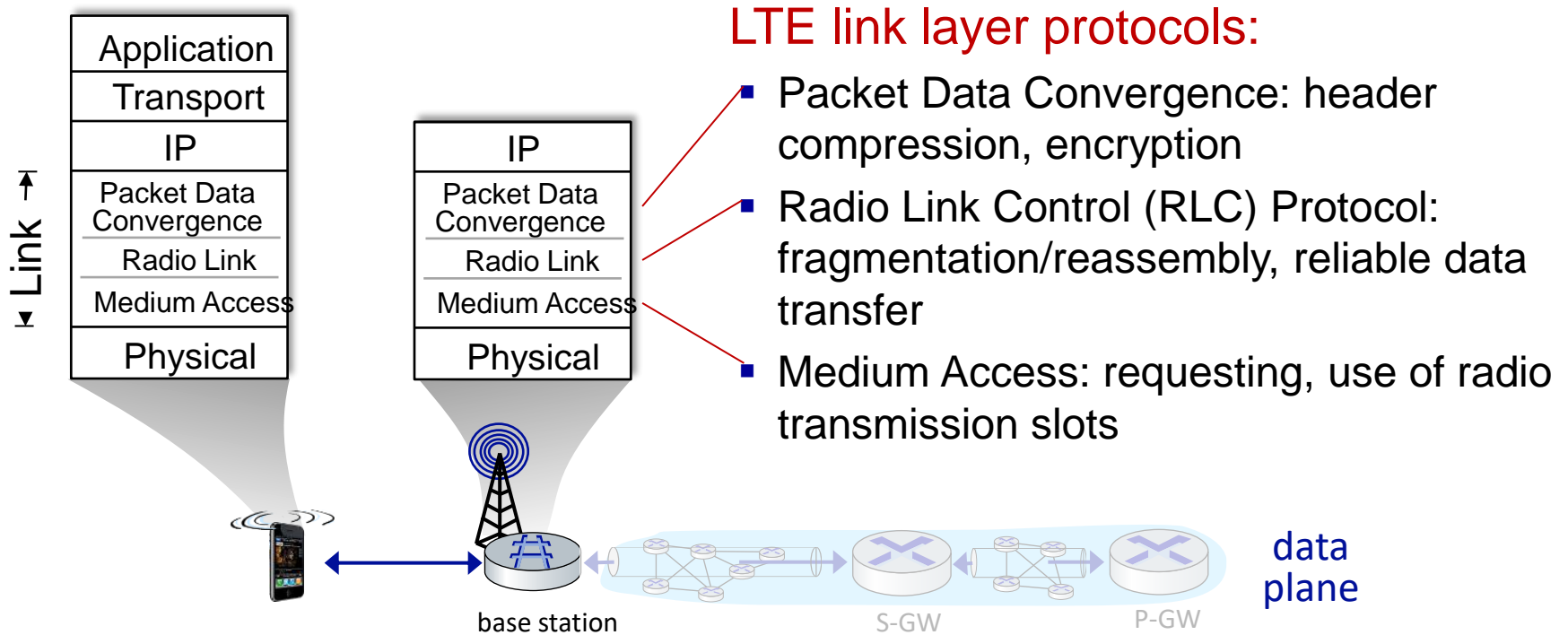

LTE data plane protocol stack: first hop

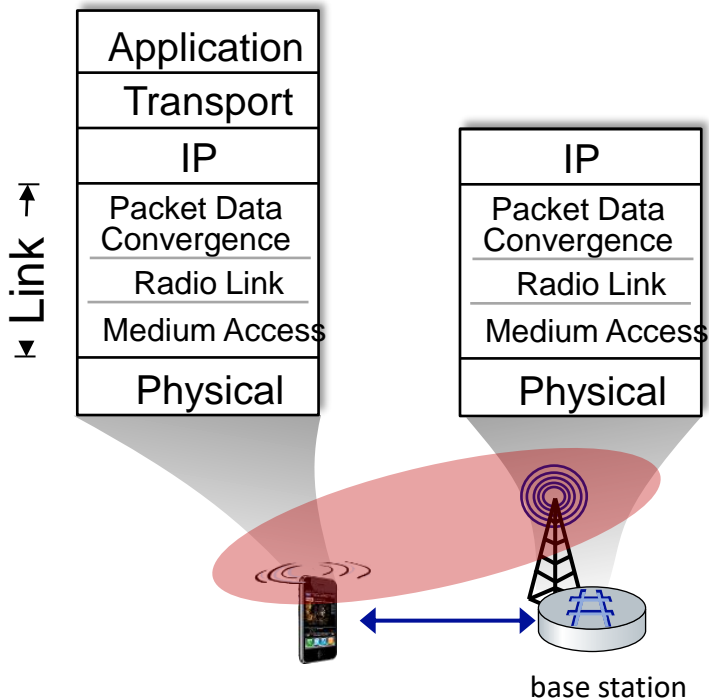

LTE radio access network:

- **downstream channel:** FDM, TDM within frequency channel (OFDM - orthogonal frequency division multiplexing)
 - “orthogonal”: minimal interference between channels
 - **upstream:** FDM, TDM similar to OFDM
- each active mobile device allocated two or more 0.5 ms time slots over 12 frequencies
 - scheduling algorithm not standardized – up to operator
 - 100’s Mbps per device possible

LTE data plane protocol stack: packet core

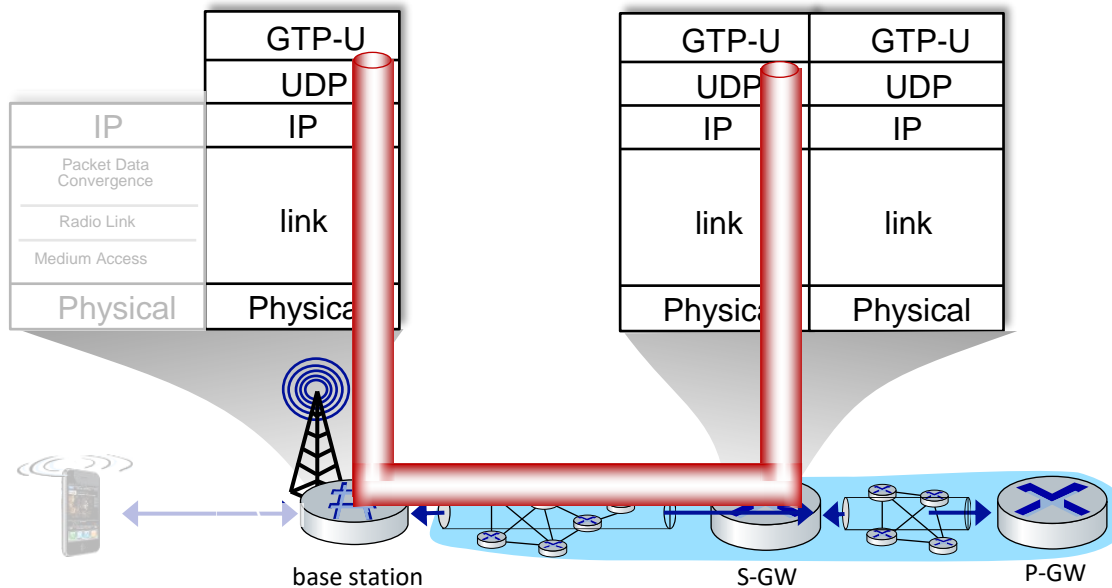

tunneling:

- mobile datagram encapsulated using GPRS Tunneling Protocol (GTP), sent inside UDP datagram to S-GW
- S-GW re-tunnels datagrams to P-GW
- supporting mobility: only tunneling endpoints change when mobile user moves

Global cellular network: a network of IP networks

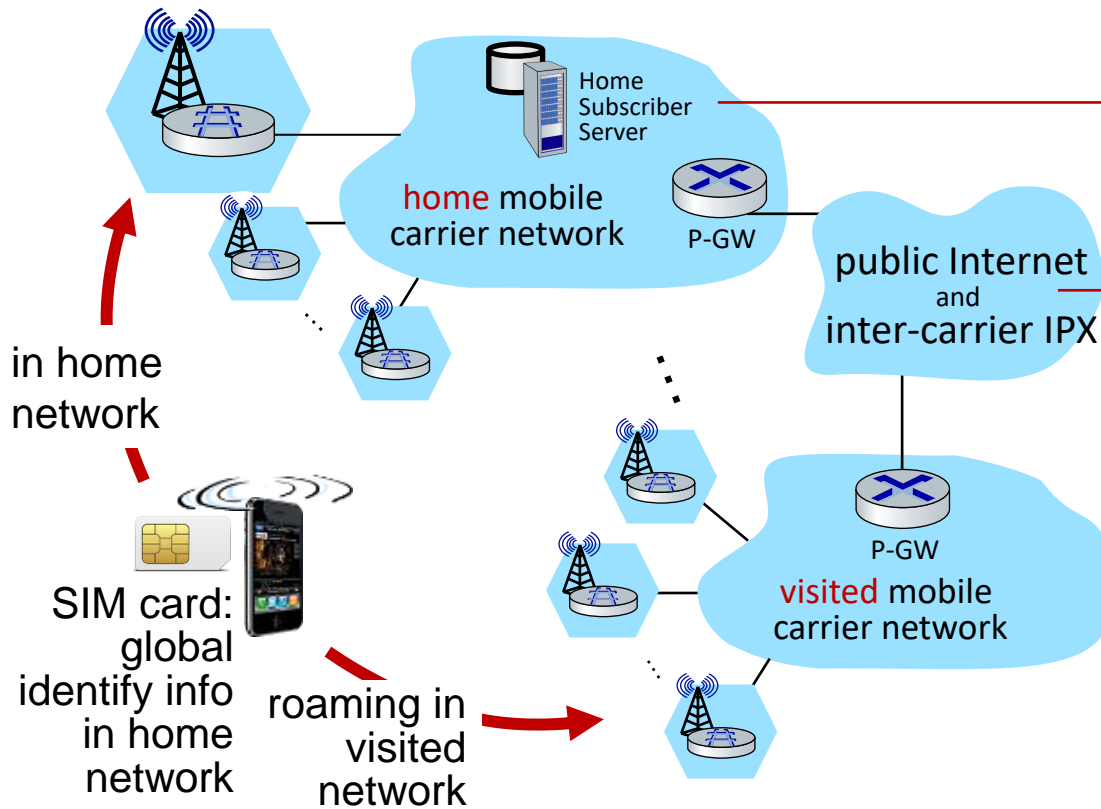

home network HSS:

- identify & services info, while in home network and roaming

all IP:

- carriers interconnect with each other, and public internet at exchange points
- legacy 2G, 3G: not all IP, handled otherwise

Connection Setup

- Session Requests
 - UE to base station
 - Base station to MME
 - MME obtains subscriber info from HSS, selects S-GW and P-GW
 - S-GW sends to P-GW
 - P-GW obtains policy from PCRF

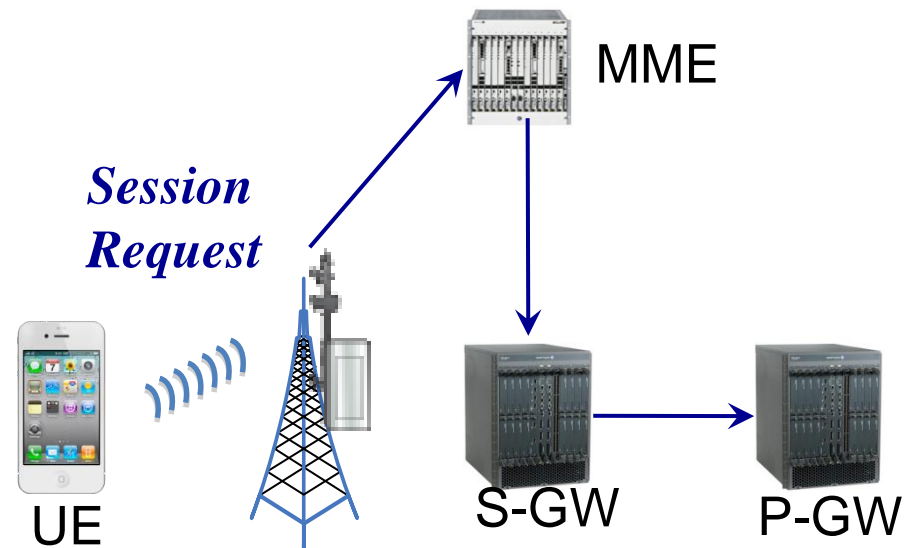

Connection Setup (Cont'd)

- Session Response
 - Establishes GPRS Tunnels (GTP) between S-GW and P-GW, between S-GW and UE
 - Base station allocates radio resources to UE

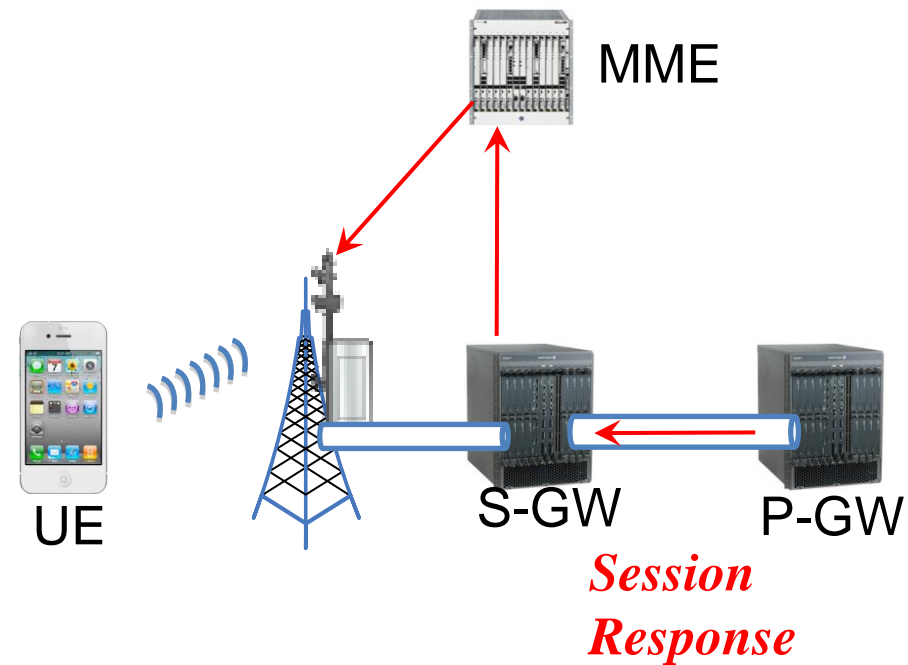

Mobility Management

Handoff

- Handoff without change of S-GW
 - No change at P-GW
- Handoff with change of S-GW or MME
- Inter-technology handoff (LTE to 3G)

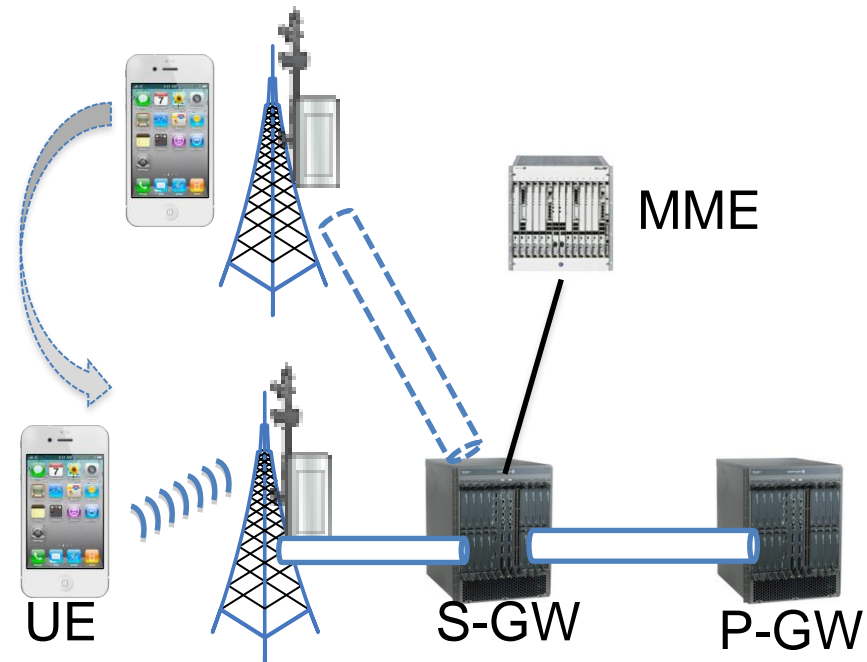

Mobility Management (Cont'd)

Paging

- If S-GW receives a packet to a UE in IDLE state, inform MME
- MME pages UE through base station

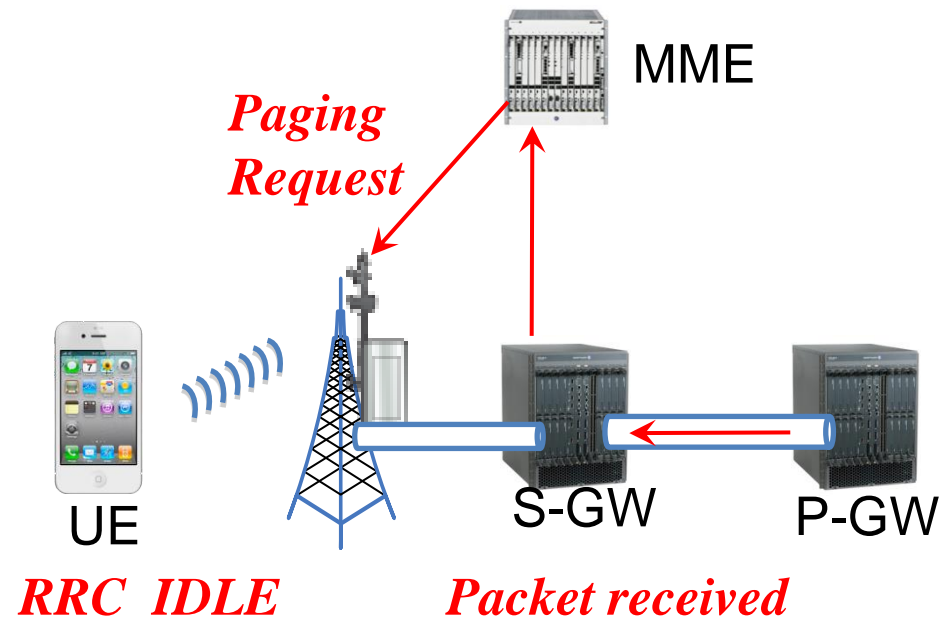

Policy and Charging Rules Function (PCRF)

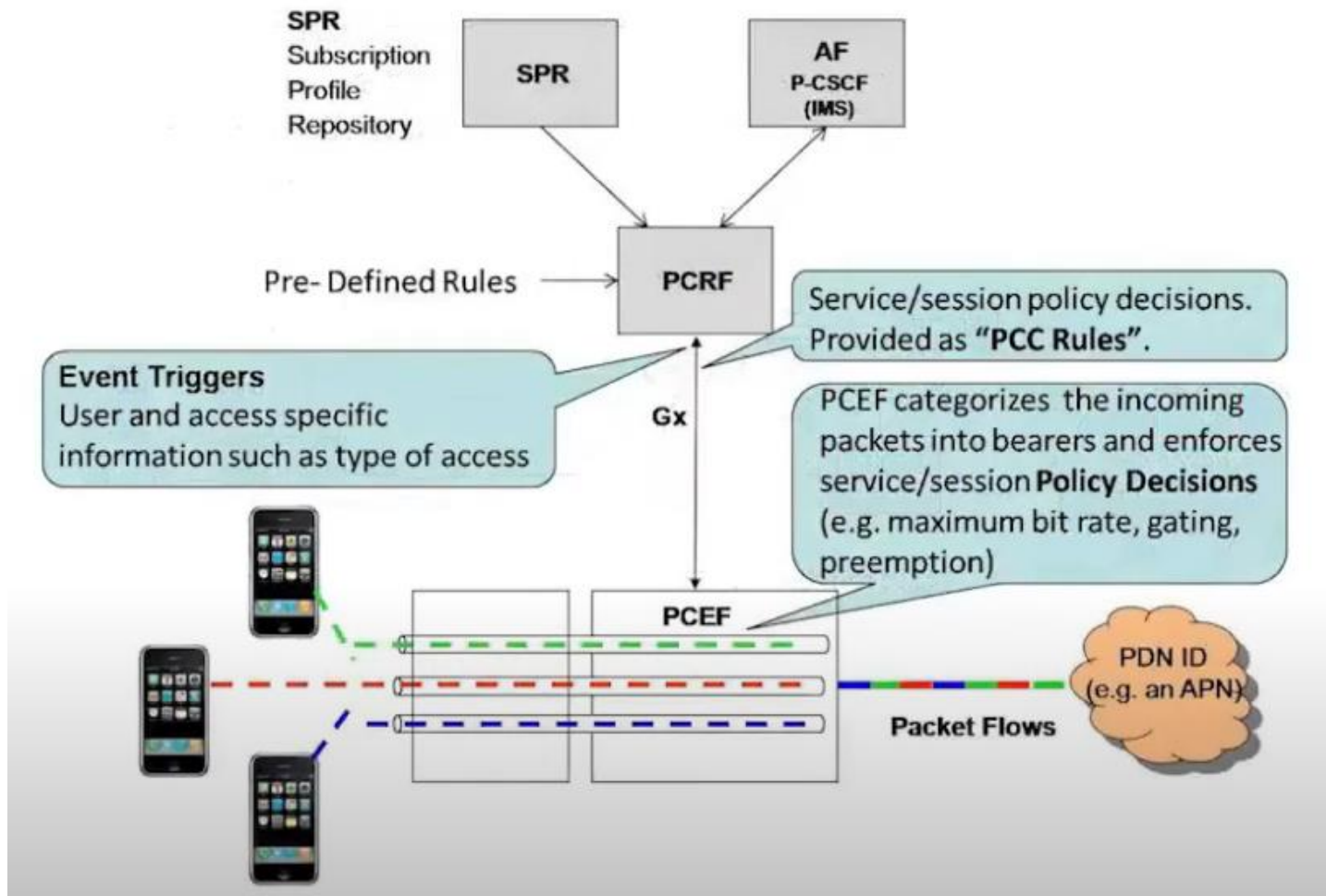

Policy and Charging Rules Function (PCRF)

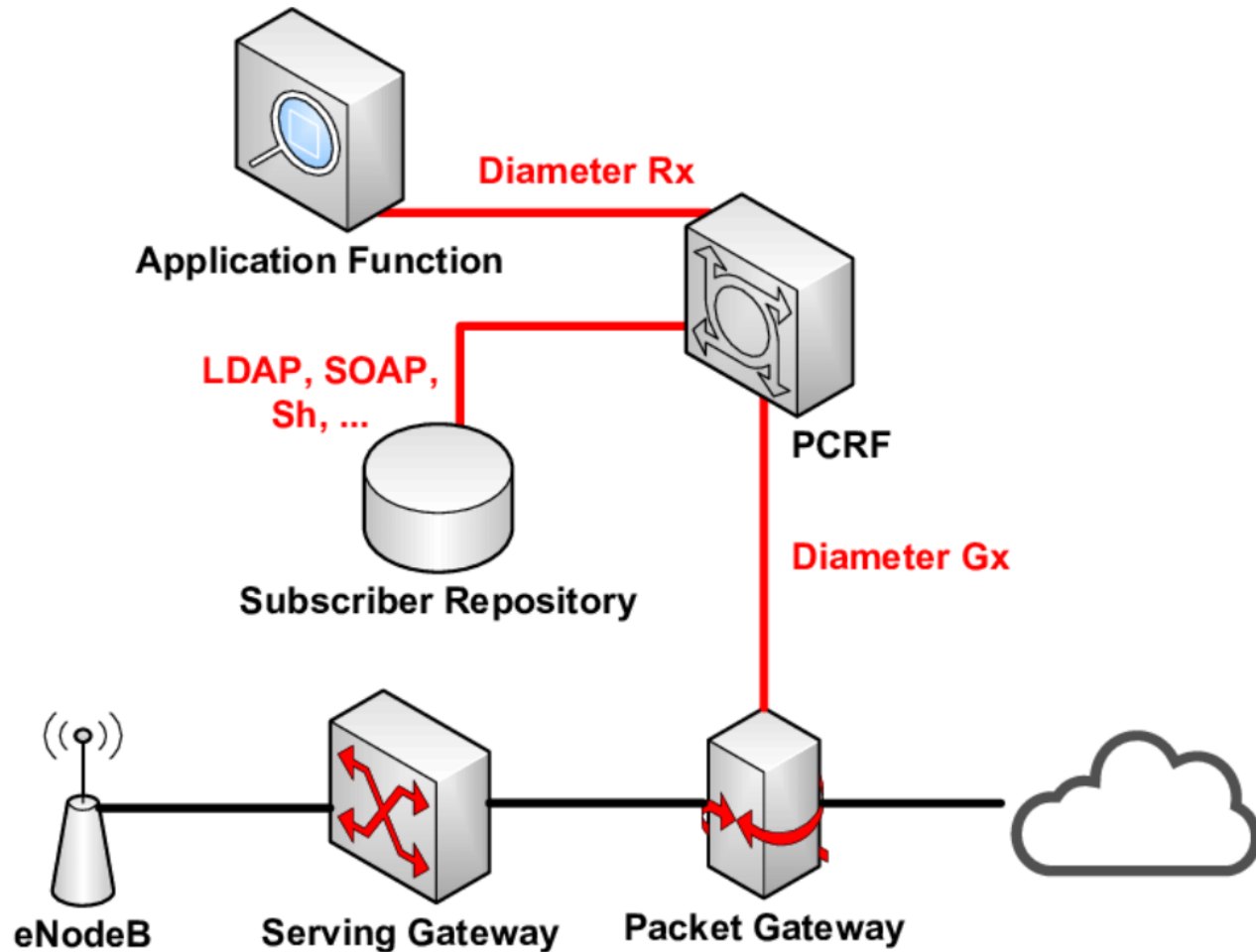

LTE vs UMTS

- Functional changes compared to the UMTS architecture

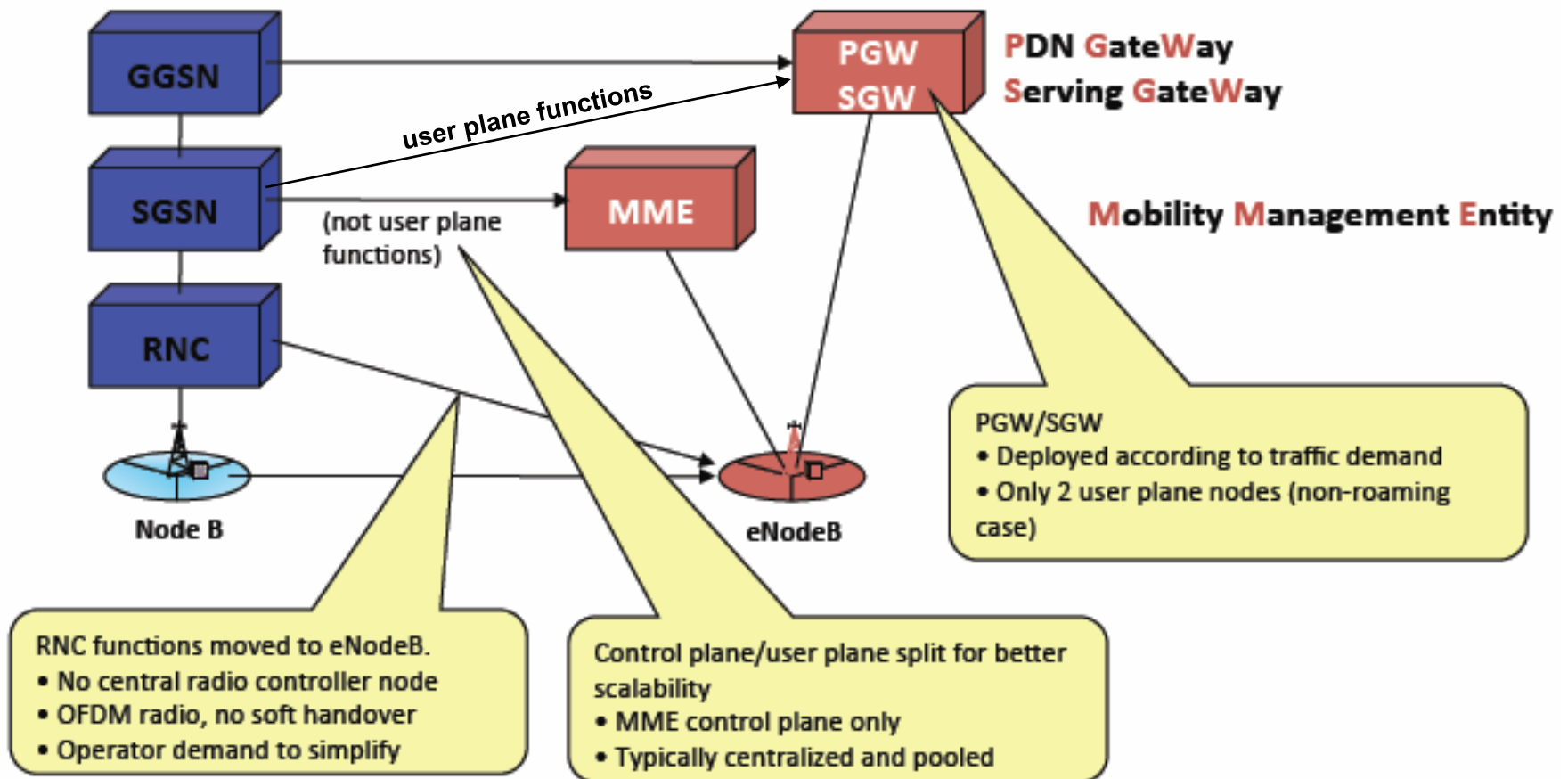

LTE vs UMTS

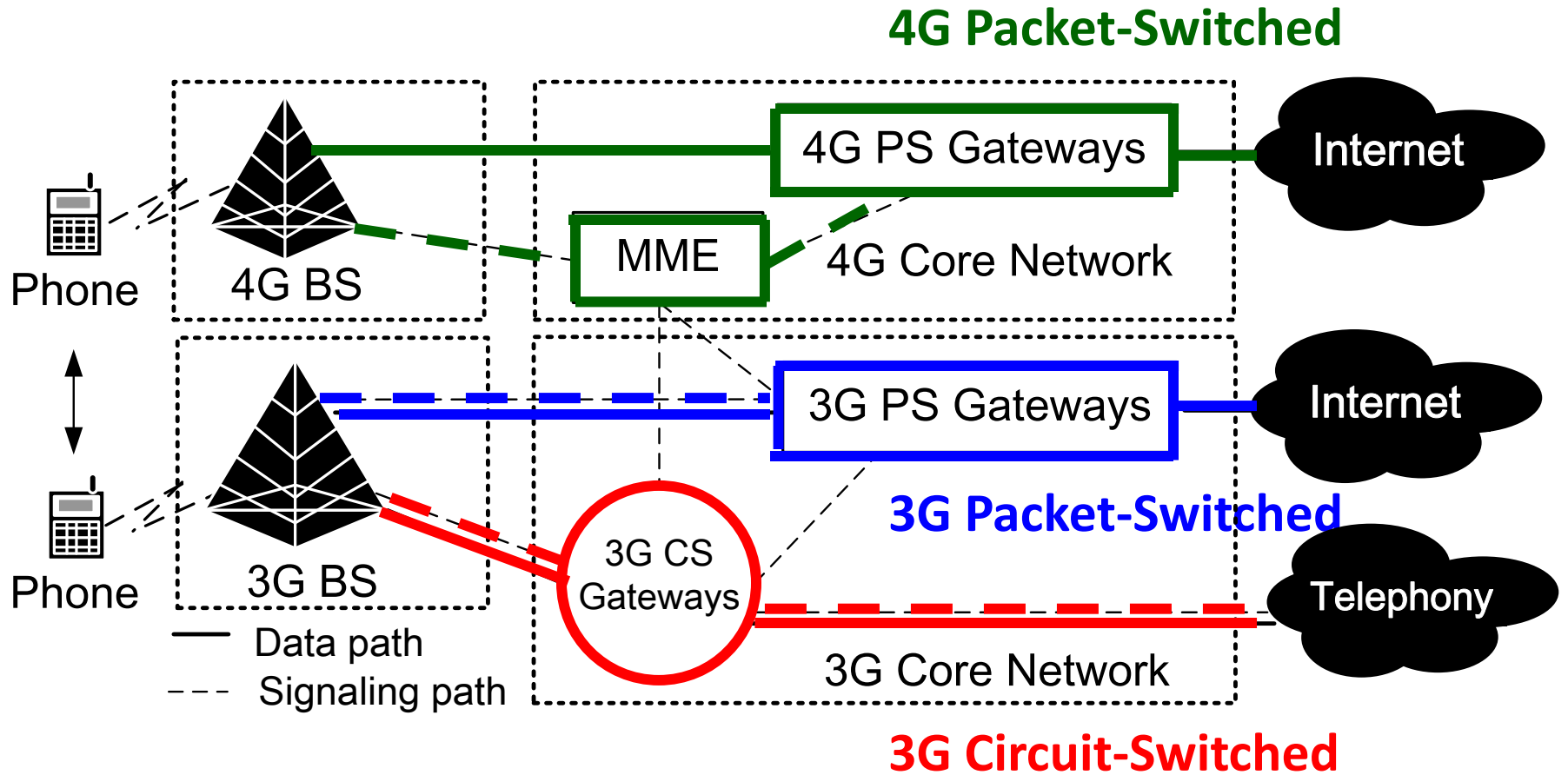

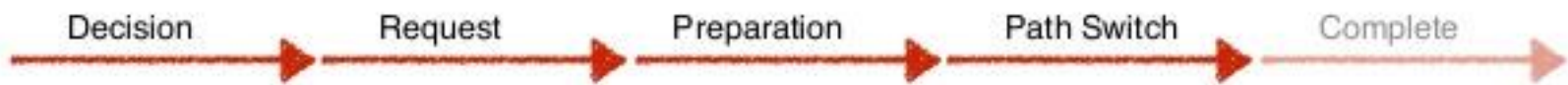

X2 Handover

Data flow during handover execution (after ho preparation):

