

THE THOLOS IN ATHENS

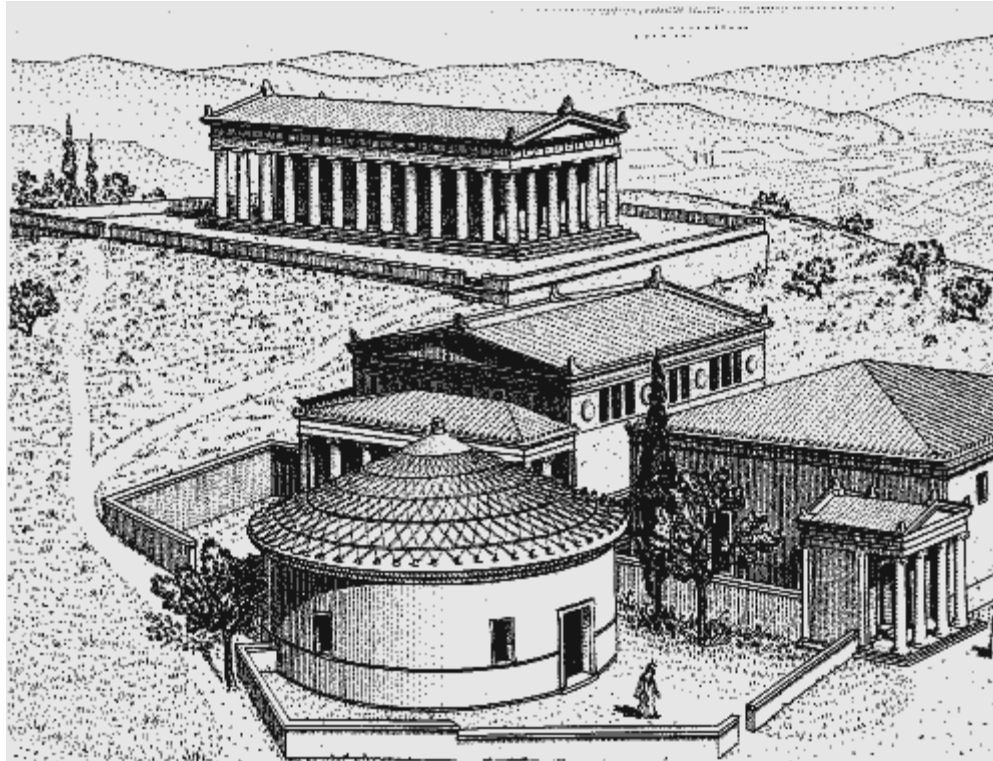

«Του βουλευτηρίου των πεντακοσίων πλησίον θόλος
εστί καλουμένη ...» Πausanίας *I.5.1.*



THOLIA AND “SKIADIA”

- Το όνομα Σκιάς αποδίδεται στη Θόλο από μια σειρά λεξικογράφων (Αμμώνιος, στο λεξικό του Αρποκρατίωνα, βλ. λ. «Θόλος», Φώτιος και Σούδα, βλ. λ. «Σκιάς», Ησύχιος, βλ. λ. «Σκιάς», EtymologicumMagnum, βλ. λ. «Σκιάς») και από επιγραφές. Οφείλεται στο γεγονός ότι το κτήριο έμοιαζε με σκιάδιον, δηλαδή με ομπρέλα ή ψάθινο καπέλο για τον ήλιο. Από τις φιλολογικές μαρτυρίες (σχολιαστής στον Αριστοφάνη, Ειρήνη, στ. 1183) αναφέρεται ότι η Θόλος ονομαζόταν επίσης Πρυτανικόν









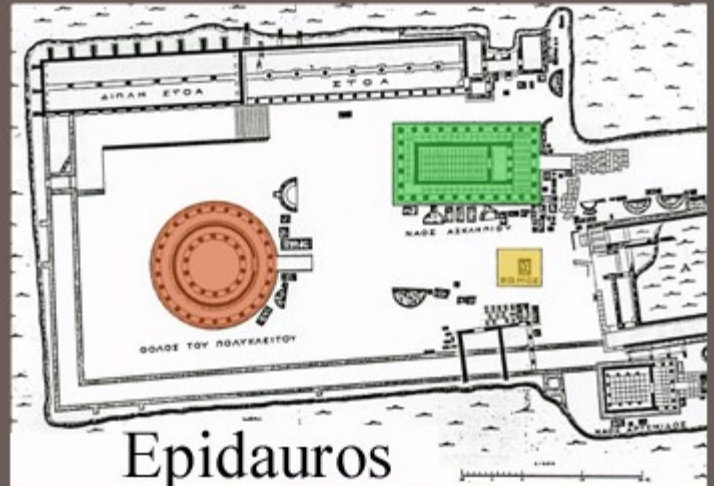
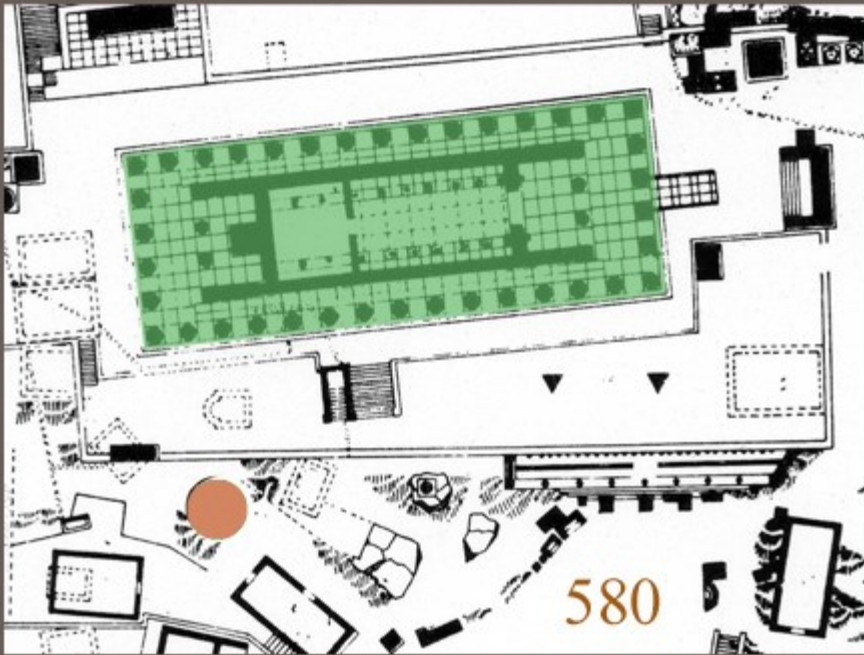

Epidaurus
360-330 ?

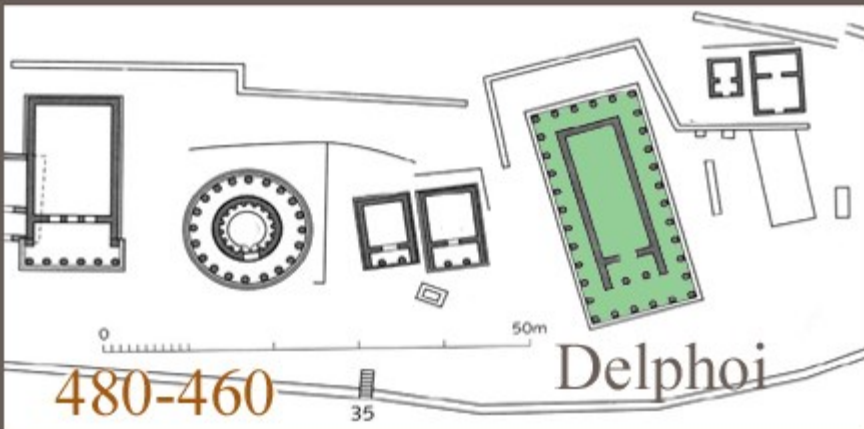

THOLOS OF SICYONIANS AT DELPHOI , 580 BC



THOLOS AT MARMARIA, DELPHOI, 380 BC

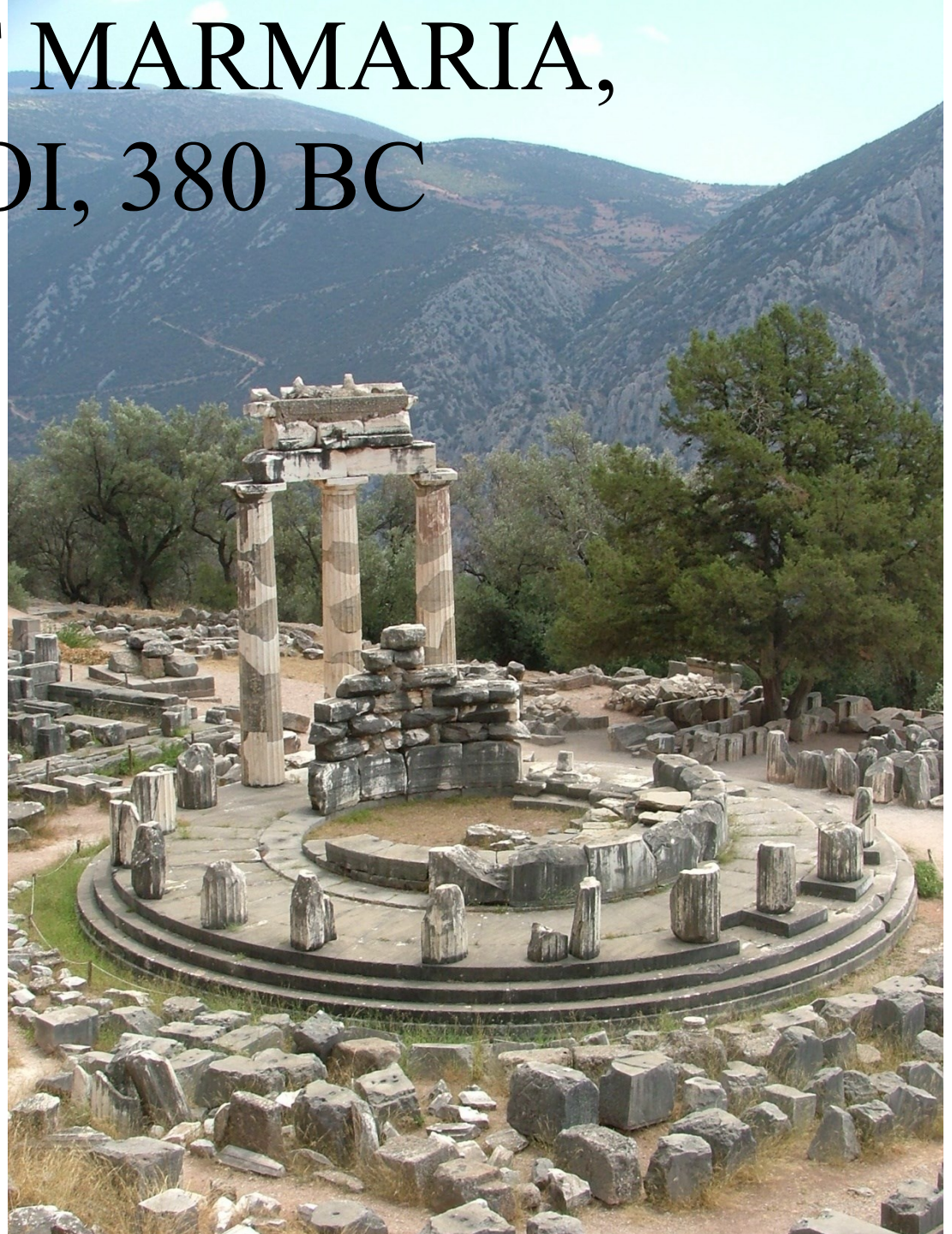



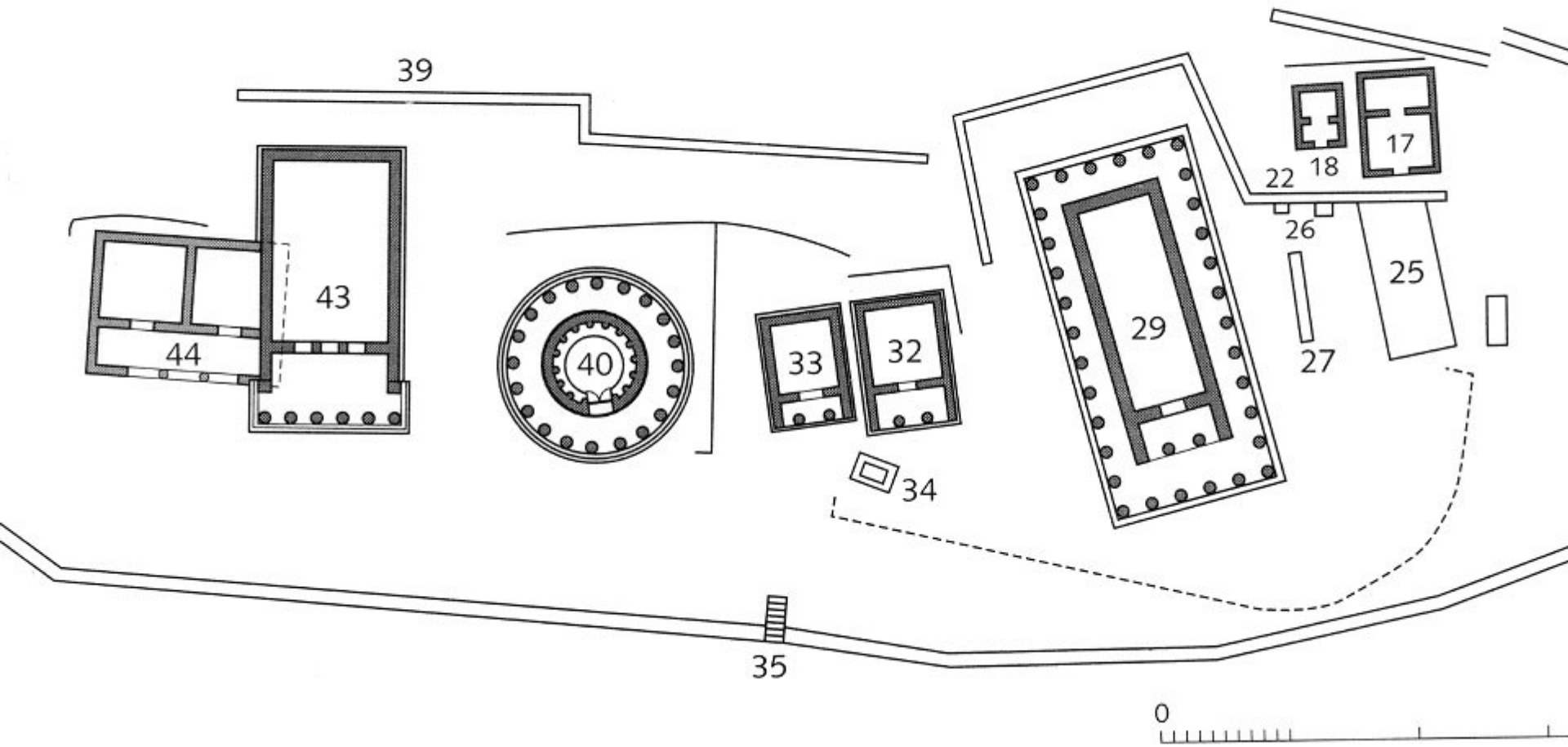



С. 310 ΔΕΛΦΟΙ. ΘΟΛΟΣ - ΜΑΡΜΑΡΙΑ - DELPHI. THOLOS - MARMARIA
DELPHES. THOLOS - MARMARIA - DELPHI. THOLOS - MARMARIA

Ν. ΣΤΟΥΡΝΑΡΑΣ

LIFE



Corinthian columns in the interior

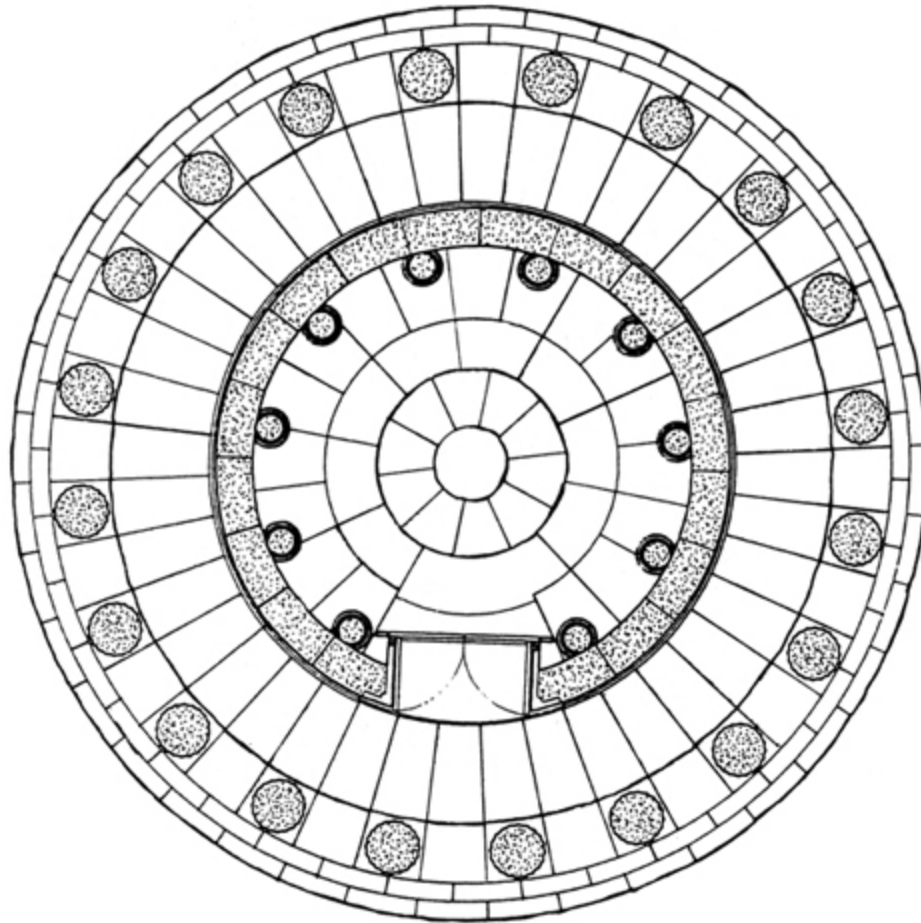

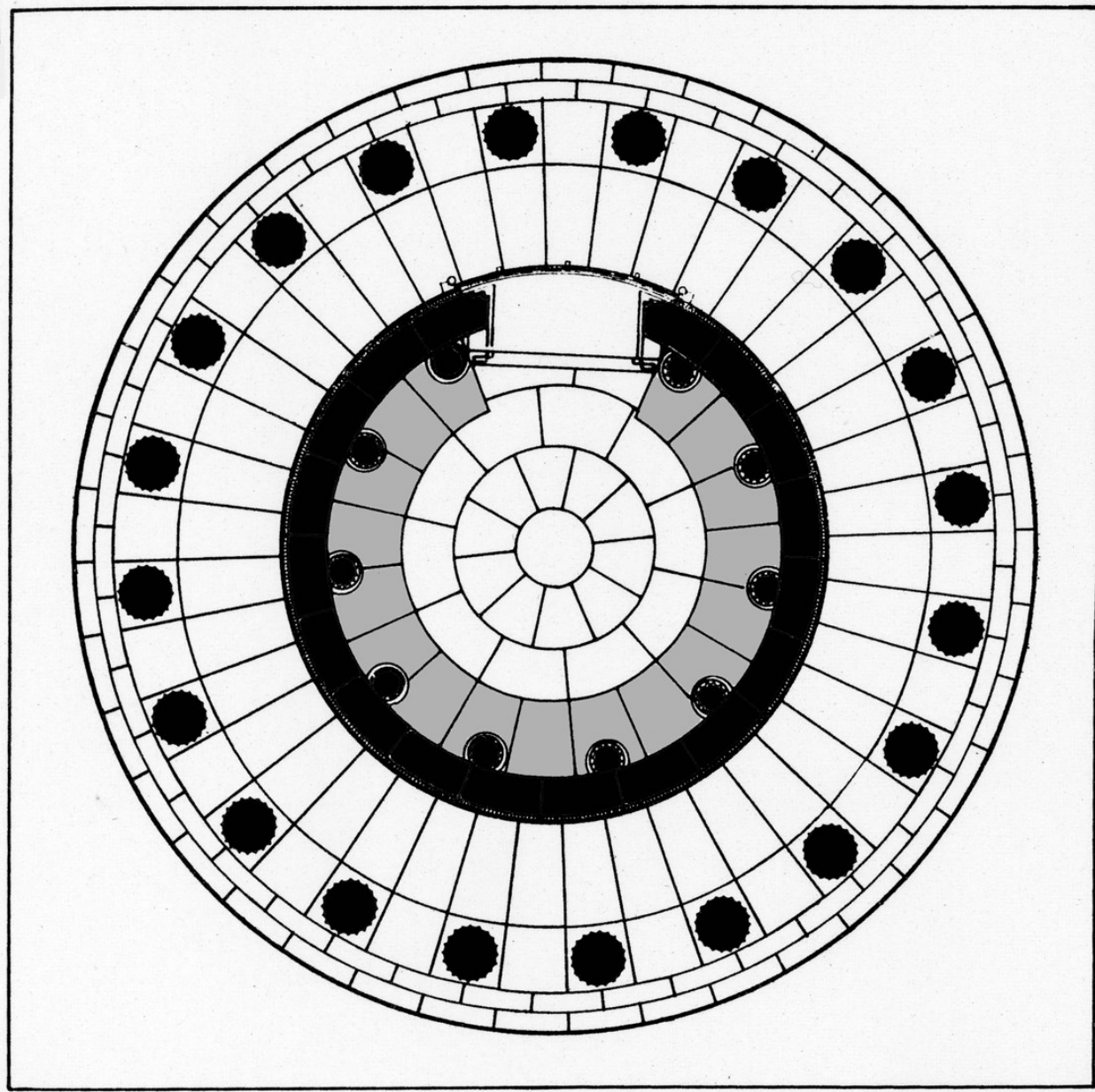



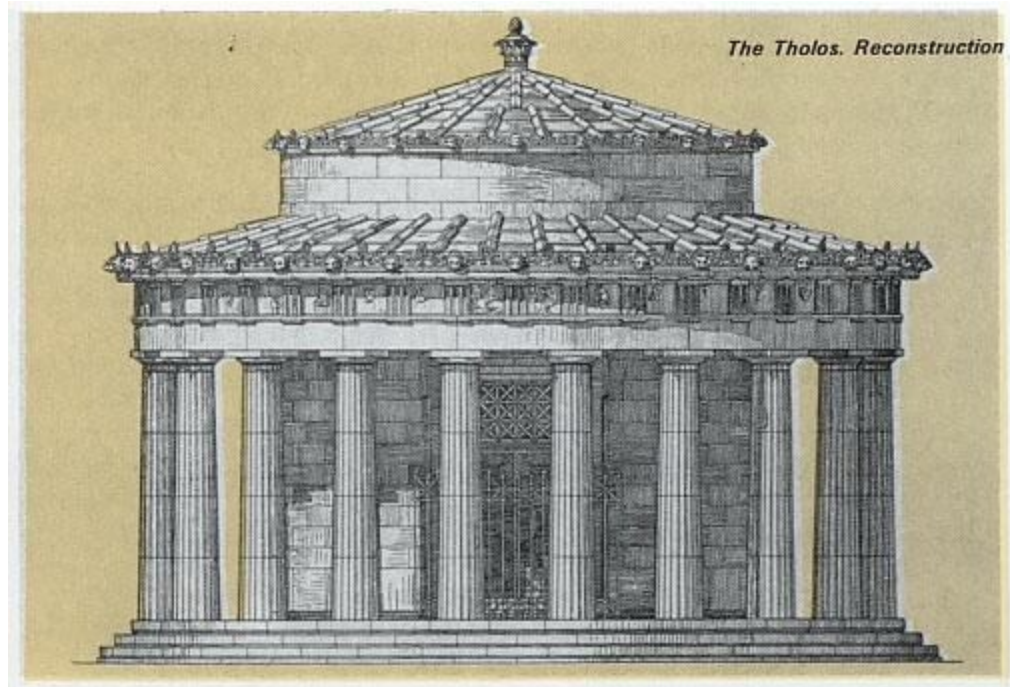

The Tholos. Reconstruction



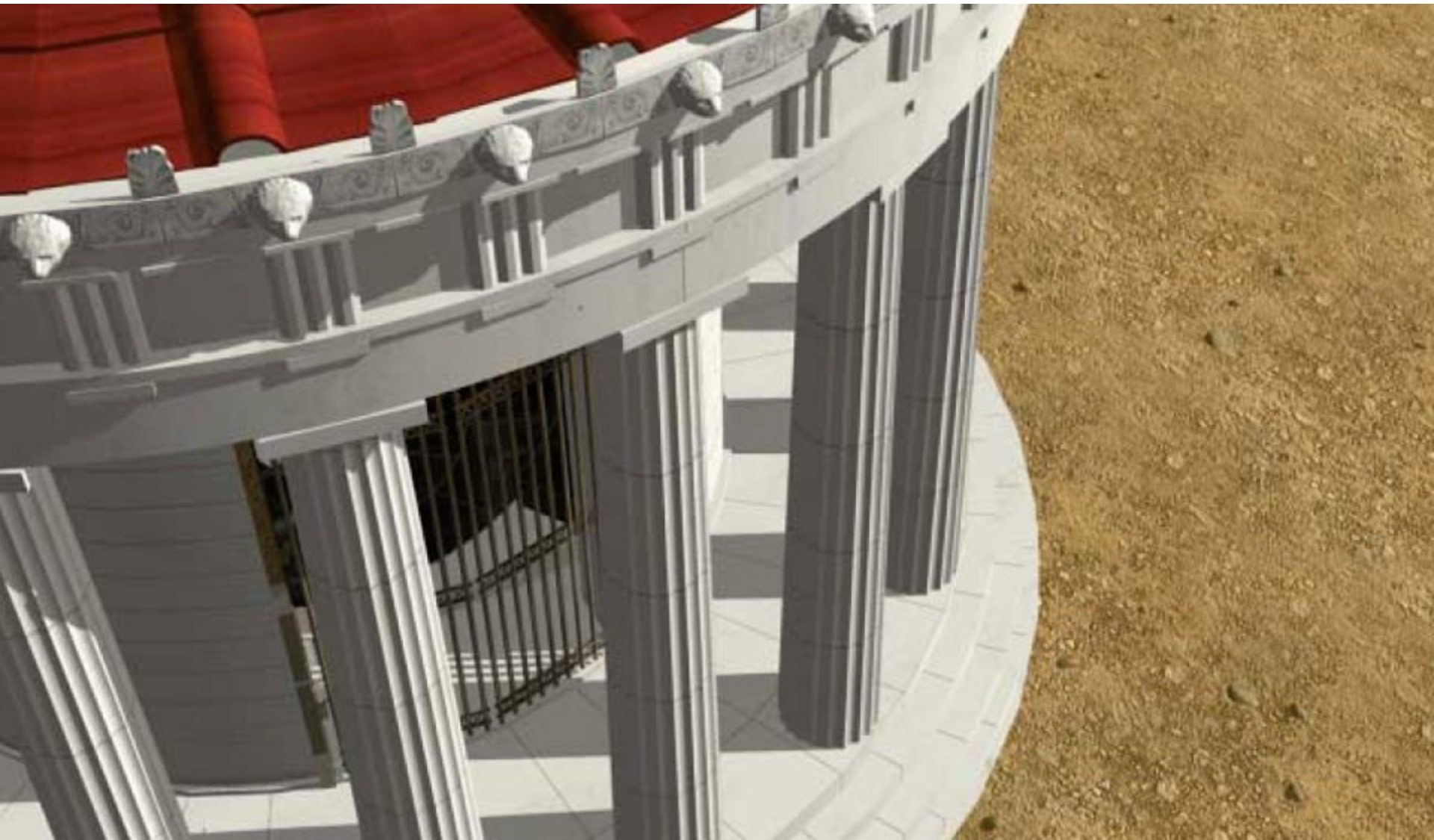



Corinthian columns in the interior

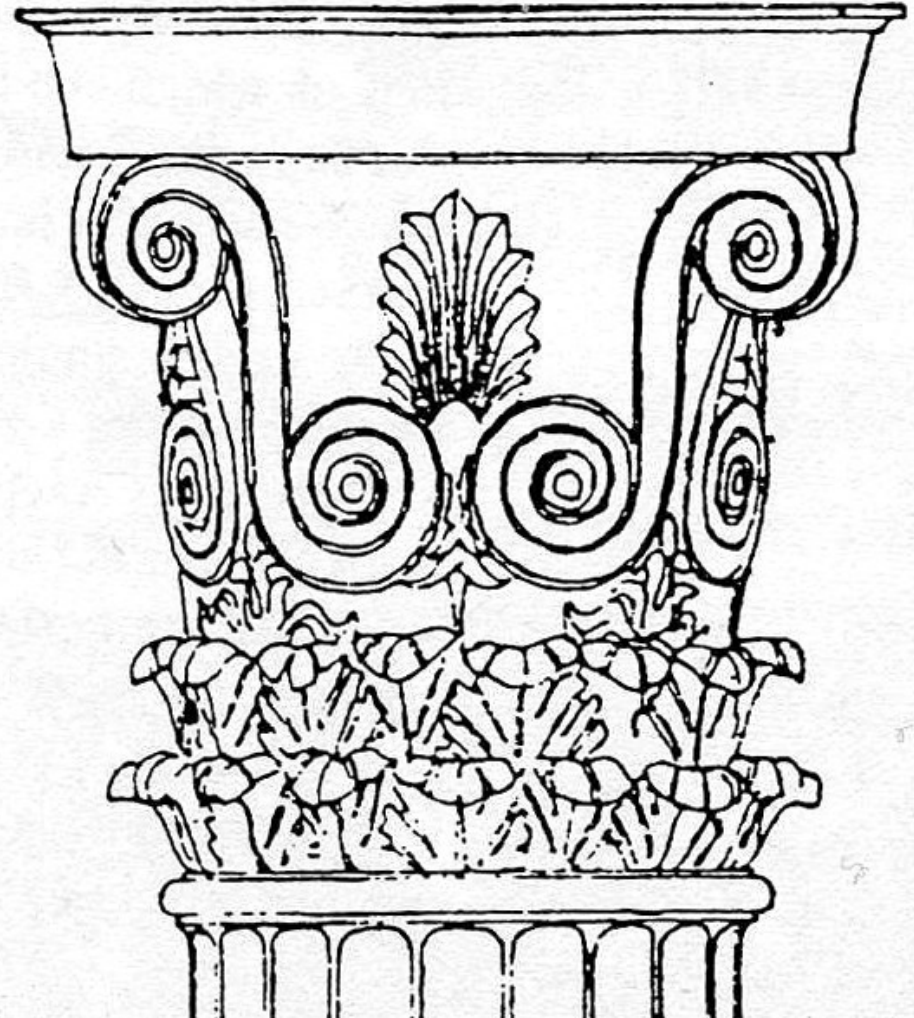
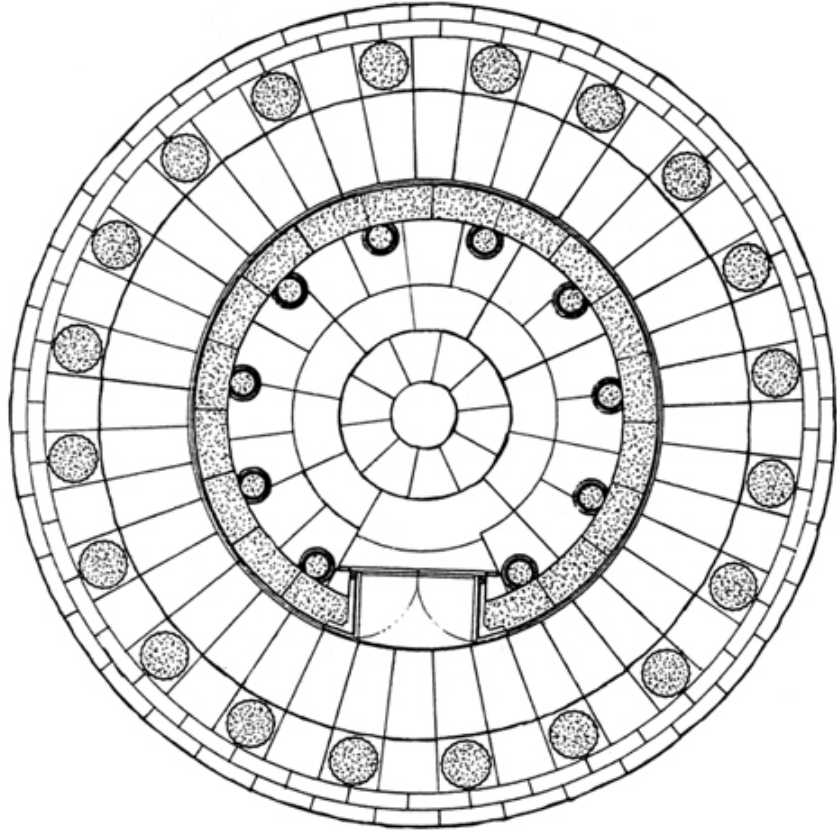

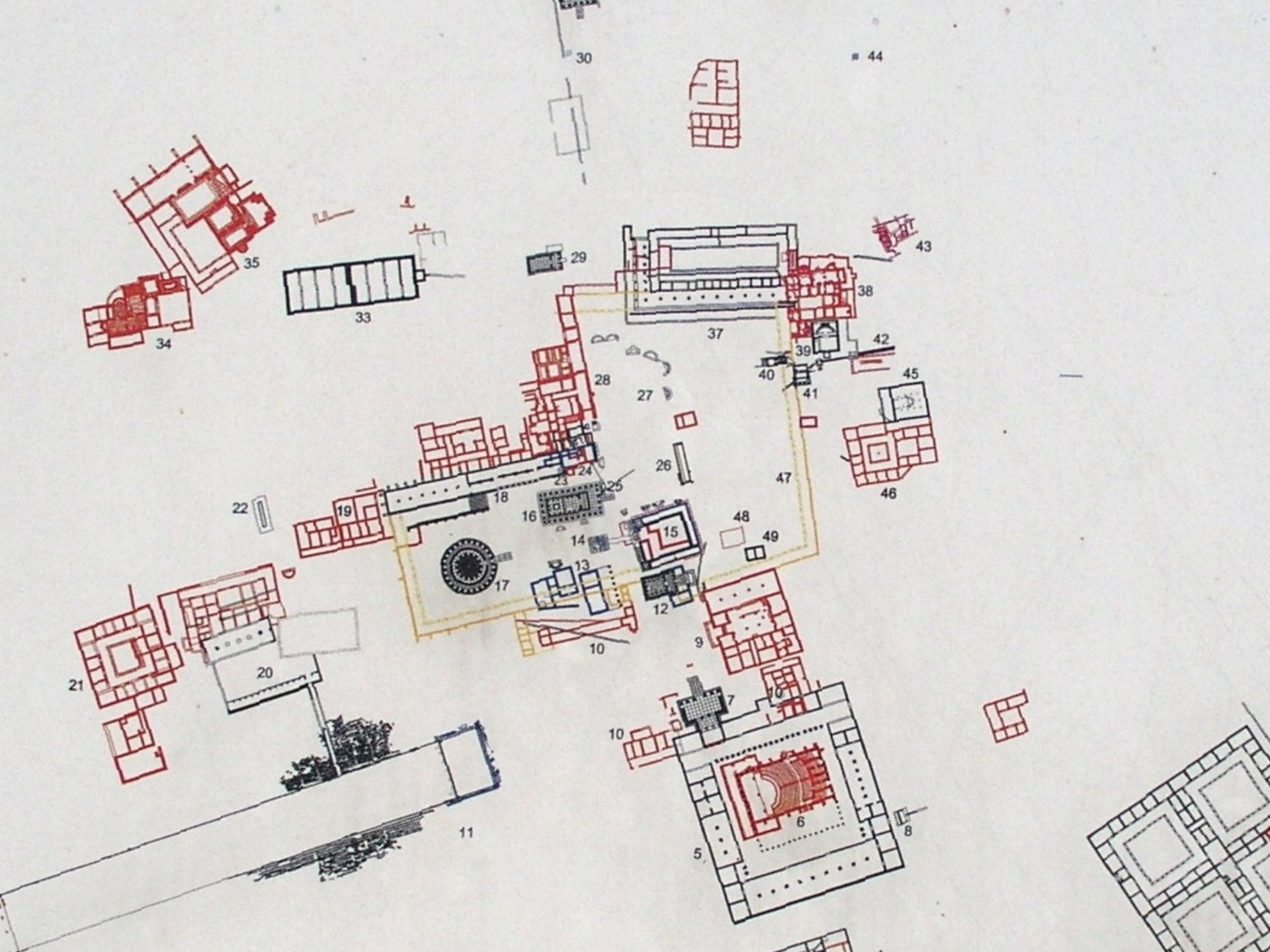

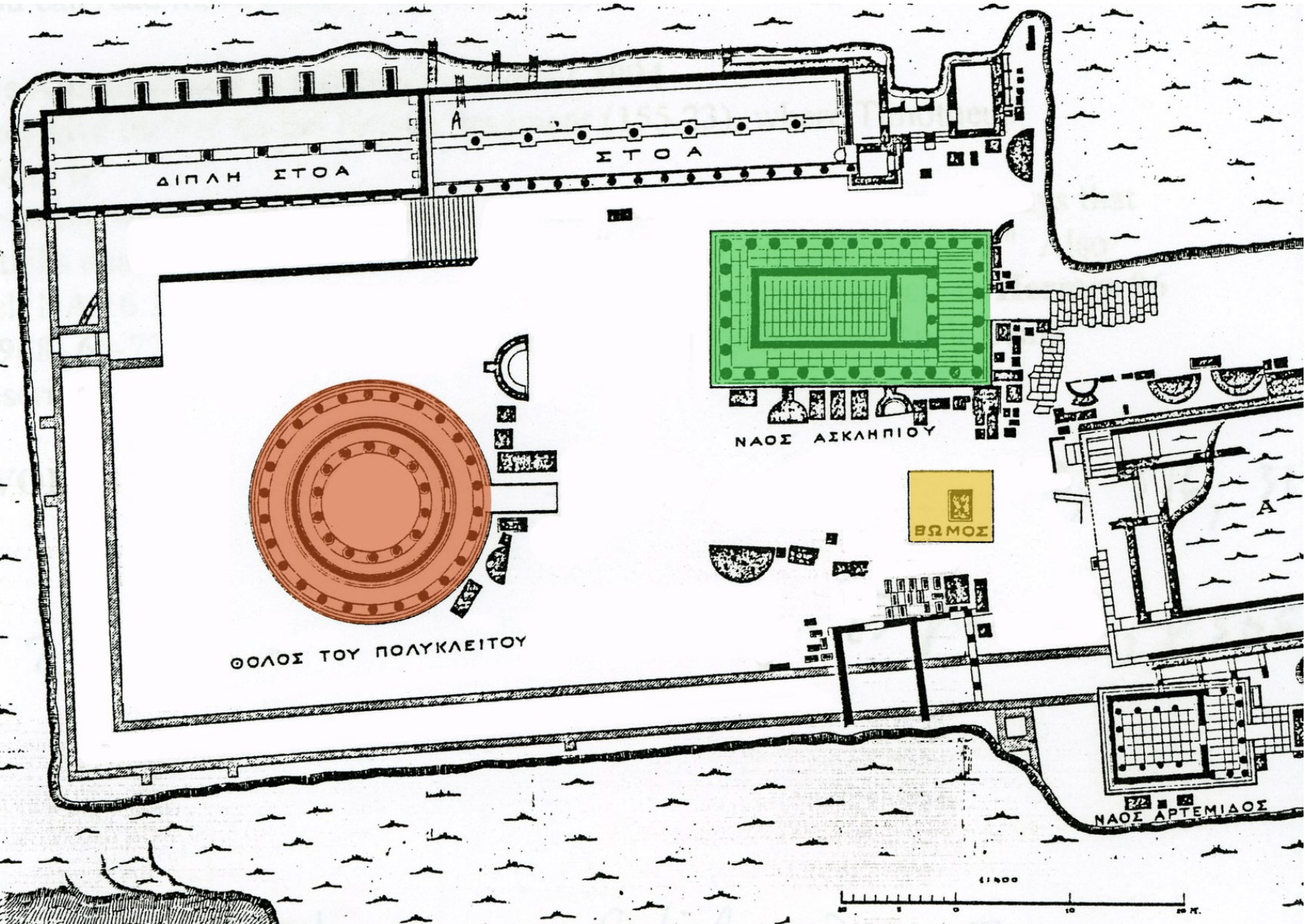

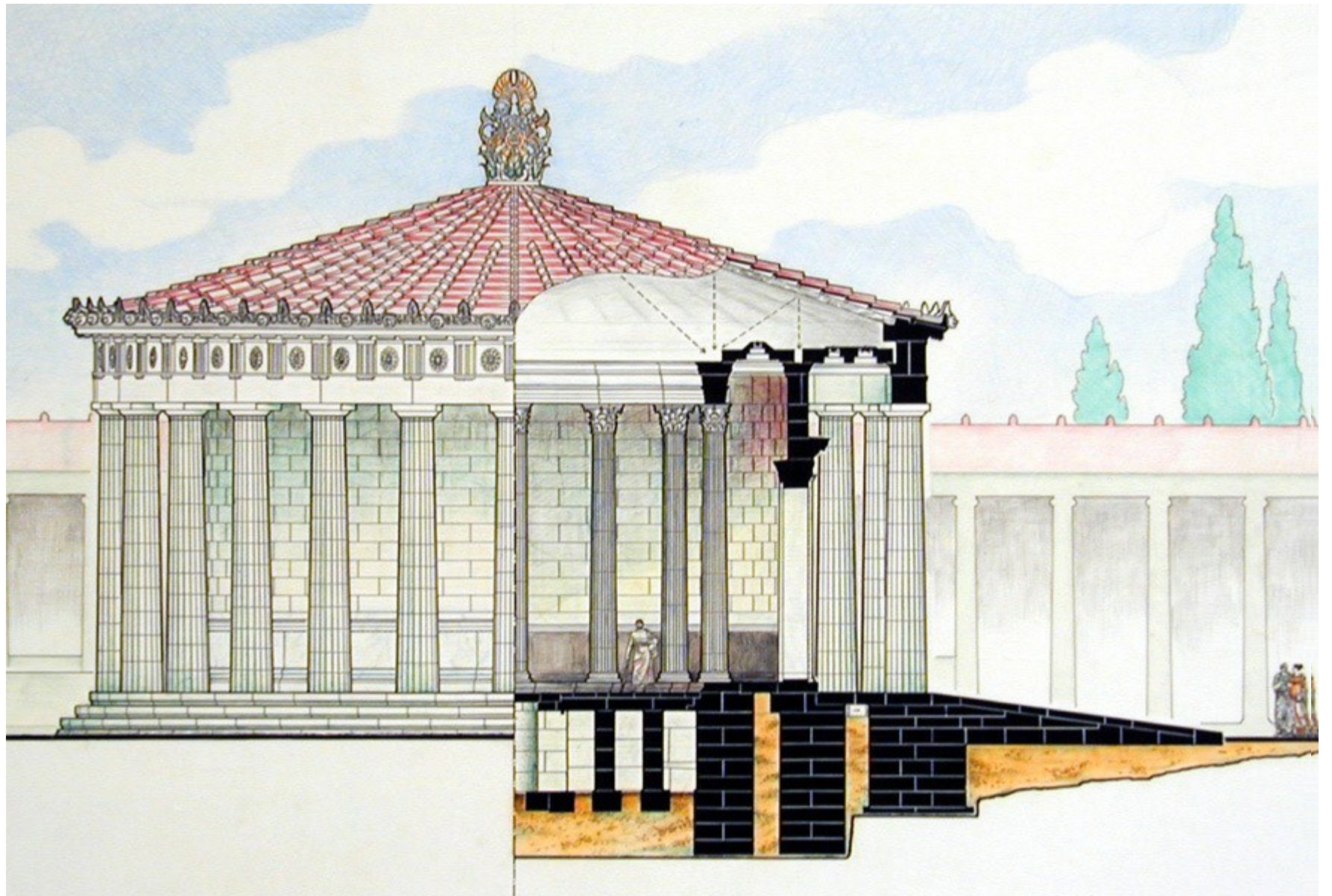

THOLOS / THYMELE, EPIDAUROS

«ΕΞΕΛΩΚΑΜΕ ΤΑΣ ΘΥΜΕΛΑΣ ΤΟ ΣΤΡΩΜΑ
ΠΟΙΗΣΑΙ ΕΝ ΤΗ ΠΕΡΙΣΤΑΣΙ, ΣΕΛΙΔΑΣ
ΠΕΝΤΗΚΟΝΤΑ ΔΥΟ, ΤΑΝ ΣΕΛΙΔΑΝ
ΕΚΑΣΤΑΝ...»

Line 162
«*Τον σακόν της θυμέλας ..*» IG 4² 1, 103.125

Οίκημα δε περιφερές λίθου λευκού
καλούμενον θόλος ωκοδόμηται πλησίον θέας
άξιον. Πausανίας 2. 27.2

Corinthian columns in the interior





Epidauros, restored Tholos
in Sanctuary of Asklepios, mid-IV BC

Corinthian columns in the interior

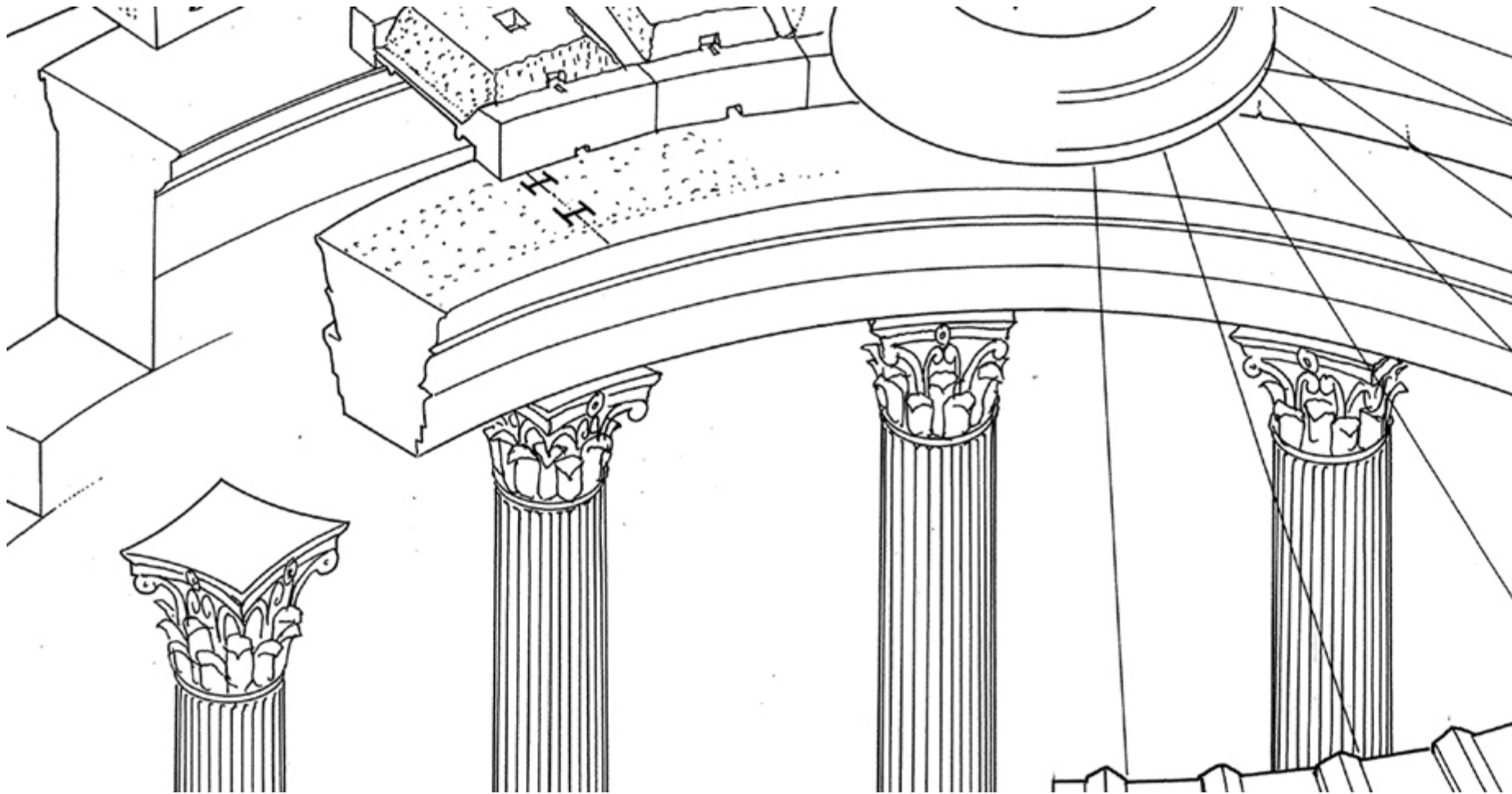

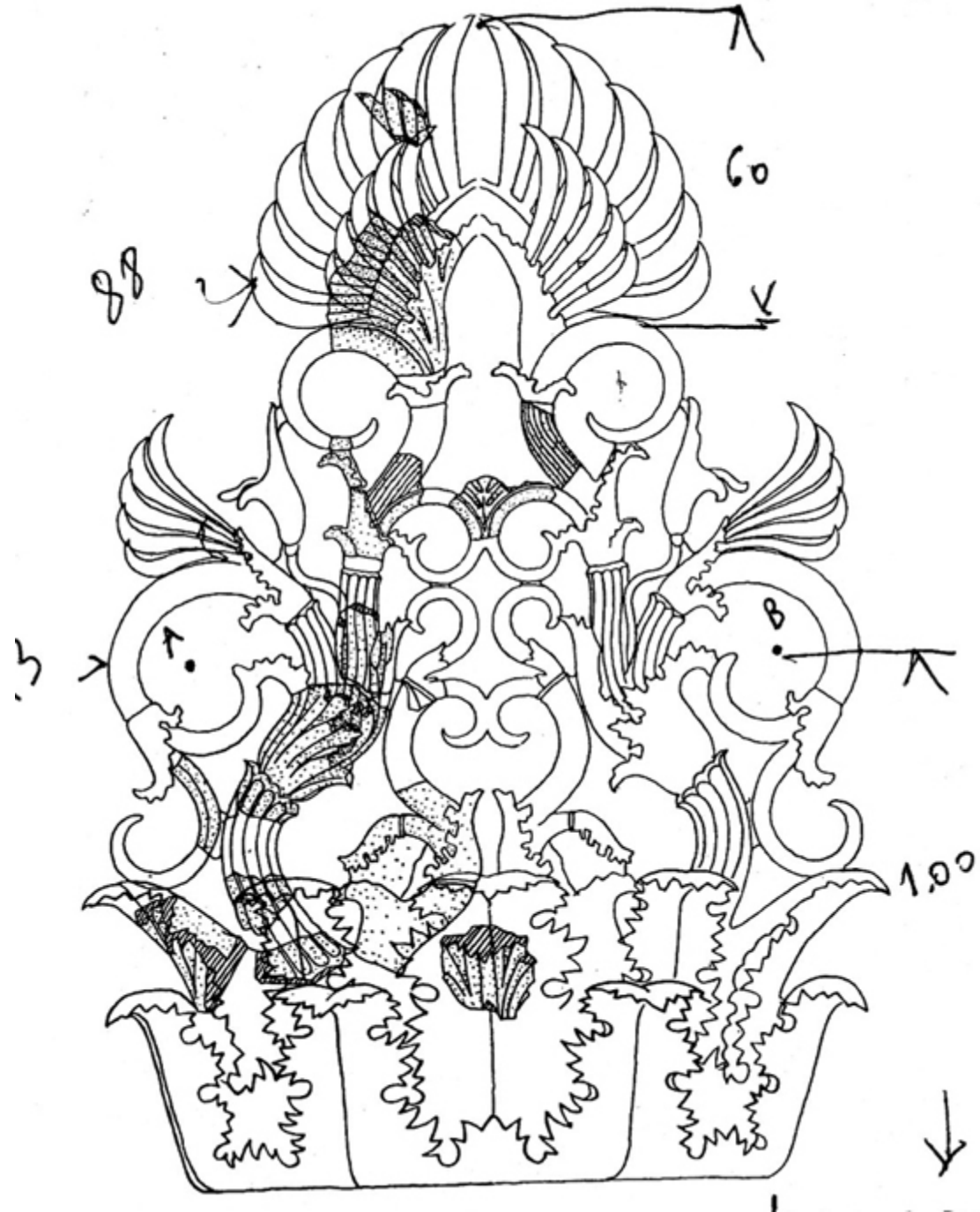
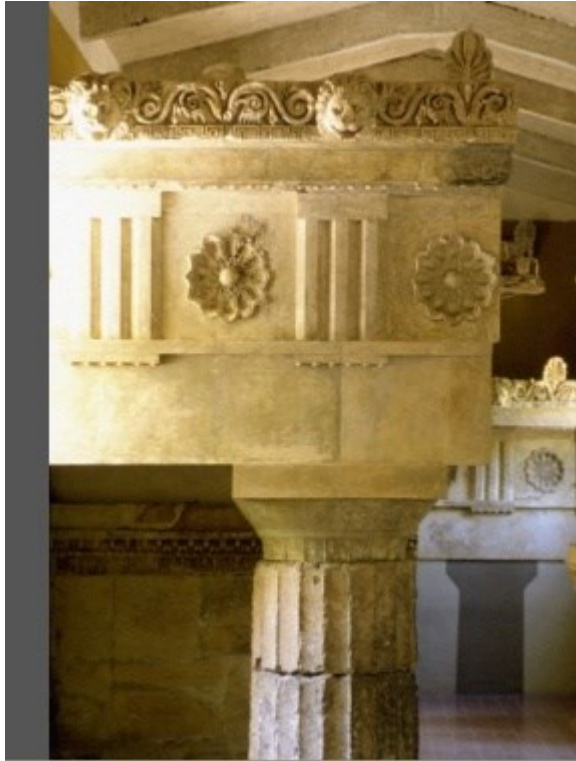











- **PAUSIAS FROM SICYON, 400-350 BC**
- ΔΙΑΣΗΜΟΣ ΓΙΑ ΈΝΑΝ ΠΙΝΑΚΑ ΤΟΥ ΜΕ ΤΑΥΡΟ ΣΕ ΘΥΣΙΑ. ΠΡΟΟΠΤΙΚΕΣ ΣΥΝΤΜΗΣΕΙΣ. ΈΝΑ ΑΝΤΙΓΡΑΦΟ ΣΤΗΘΗΚΕ ΣΤΟΝ ΠΡΟΝΑΟ ΤΟΥ ΝΑΟΥ ΤΗΣ ΟΜΟΝΟΙΑΣ ΣΤΗ ΡΩΜΗ
- ΕΦΕΥΡΕΤΗΣ ΤΗΣ ΕΓΚΑΥΣΤΙΚΗΣ ΤΕΧΝΙΚΗΣ
- ΕΦΕΥΡΕΤΗΣ ΤΩΝ ΓΡΑΠΤΩΝ ΟΡΟΦΩΝ
- ΦΙΛΟΤΕΧΝΗΣΕ ΤΟ ΕΣΩΤΕΡΙΚΟ ΤΗΣ ΘΟΛΟΥ ΣΤΗΝ ΕΠΙΔΑΥΡΟ. «ΛΗΘΗ ΚΑΙ ΕΡΩΣ» * ΠΑΥΣΑΝΙΑΣ. ΣΥΝΕΡΓΑΣΙΑ ΜΕ ΤΟΝ
- **POLYCLEITOS THE YOUNGER FROM ARGOS**

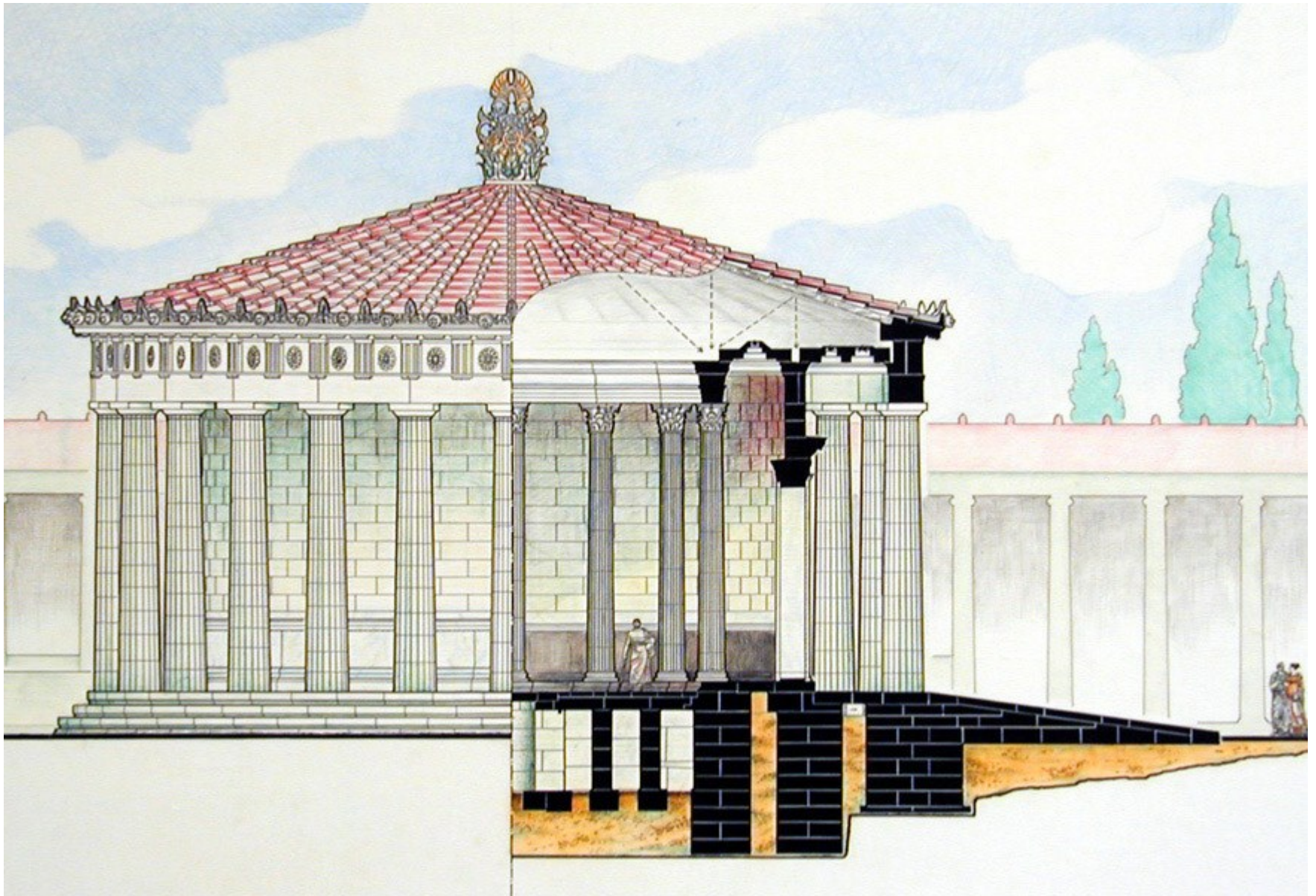

THE “LABYRINTH”







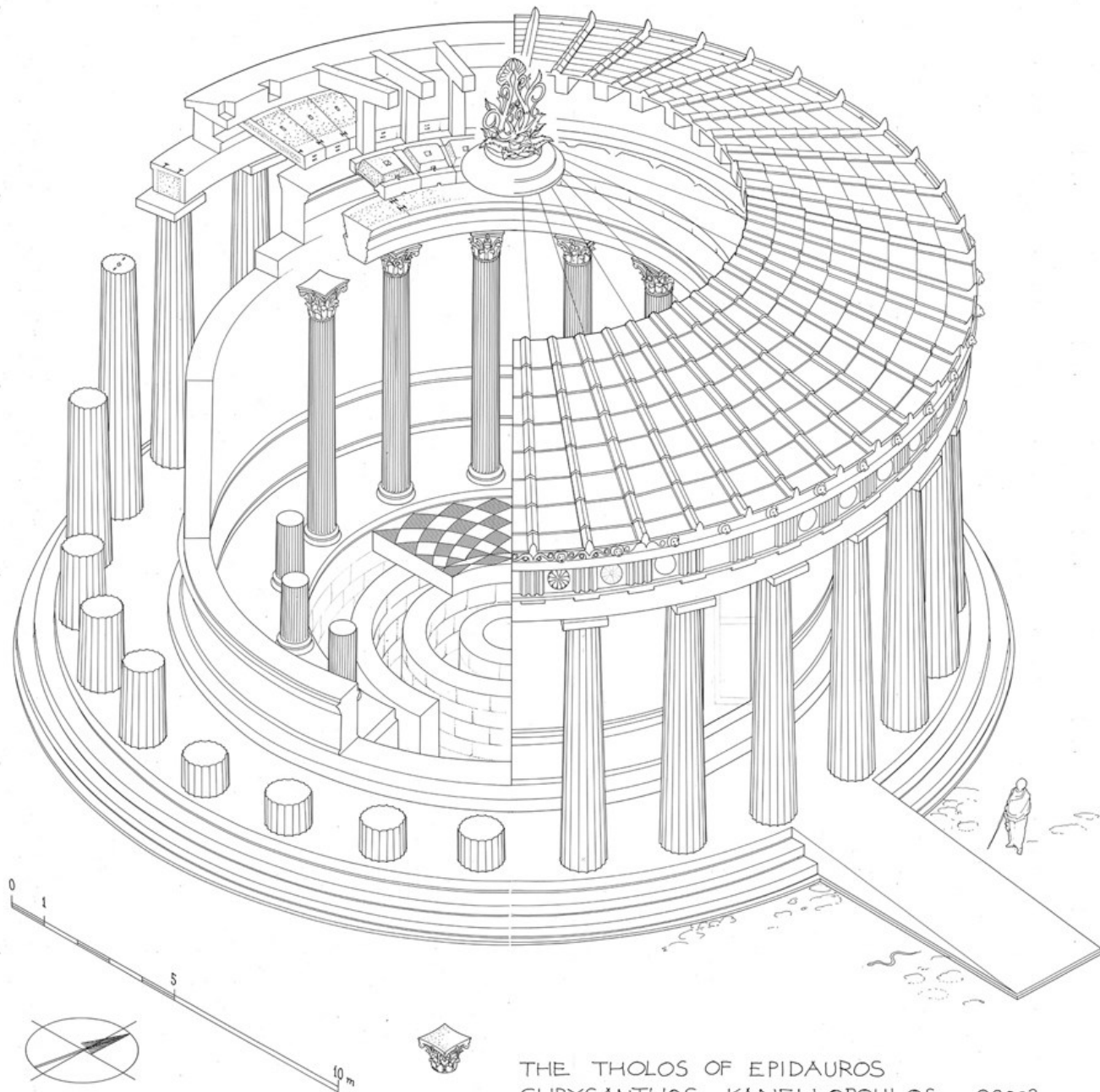

THE THOLOS OF EPIDAUROS
CHRYSANTHOS KANELLOPOULOS ©2002

USE OF THE “LABYRINTH”

- F. Robert 1939: εναγιστήριον?
- Καββαδίας 1900: PRYTANEION
- INITIATIONS
- Defrasse-Lechat 1895: WATER
RESERVOIR
- Holwerda 1904; Kerényi 1959: SACRED
SNAKES
- Riethmüller 2005: OFFERING OF EGGS!
- ASCLEPIUS' TOMB

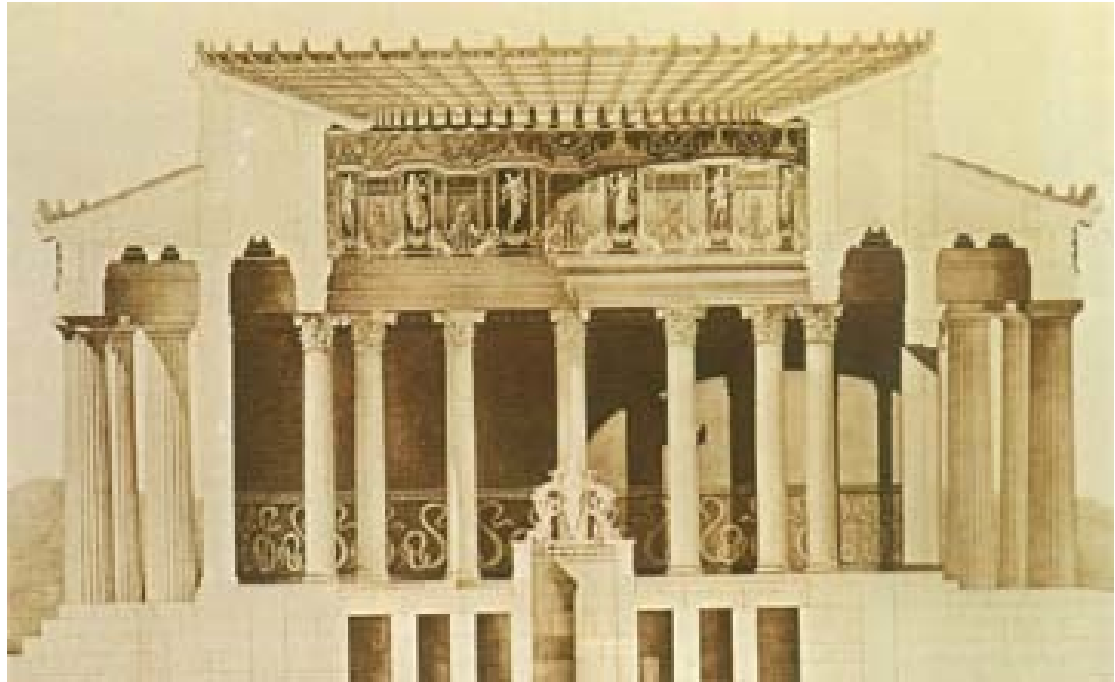

TROPHONIOS, CAVE

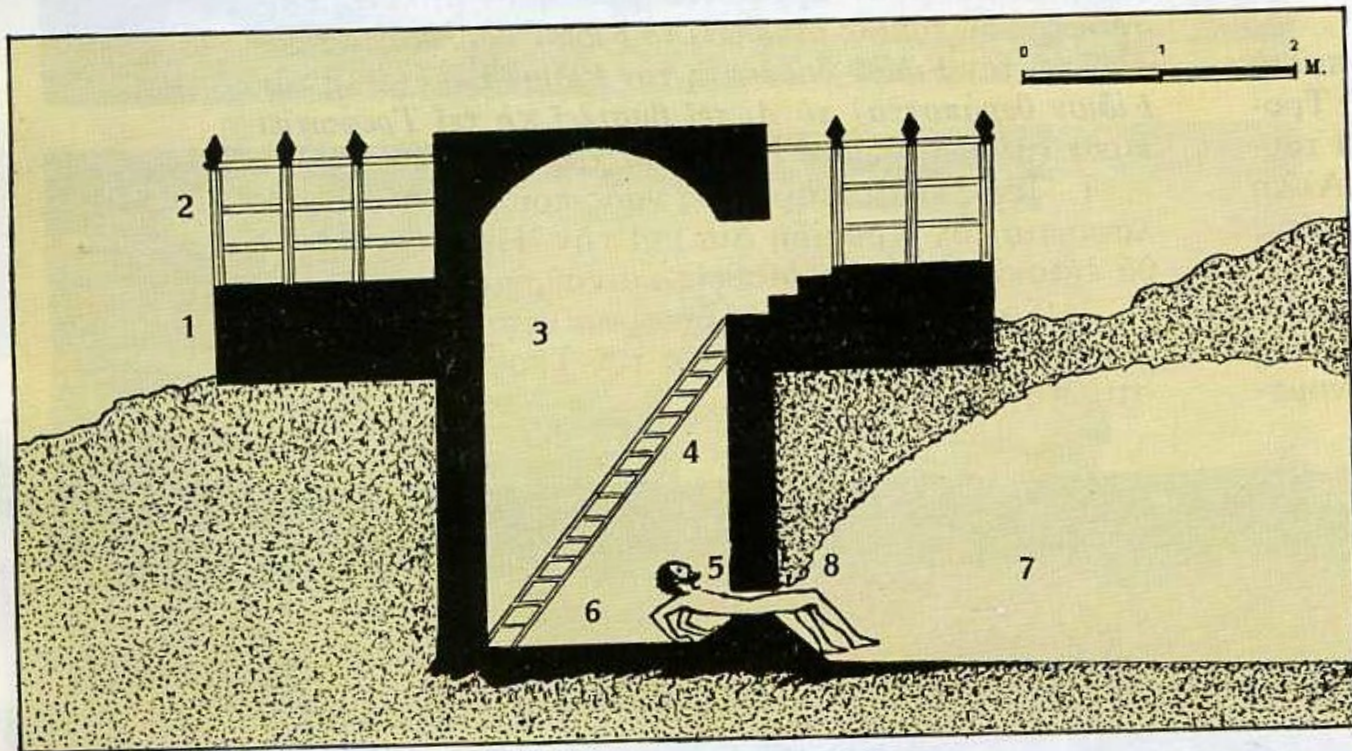

... τις κρήνες του τεμένους: οχι τρευόμε

Σ
Τ
Γ
Τ
Κ

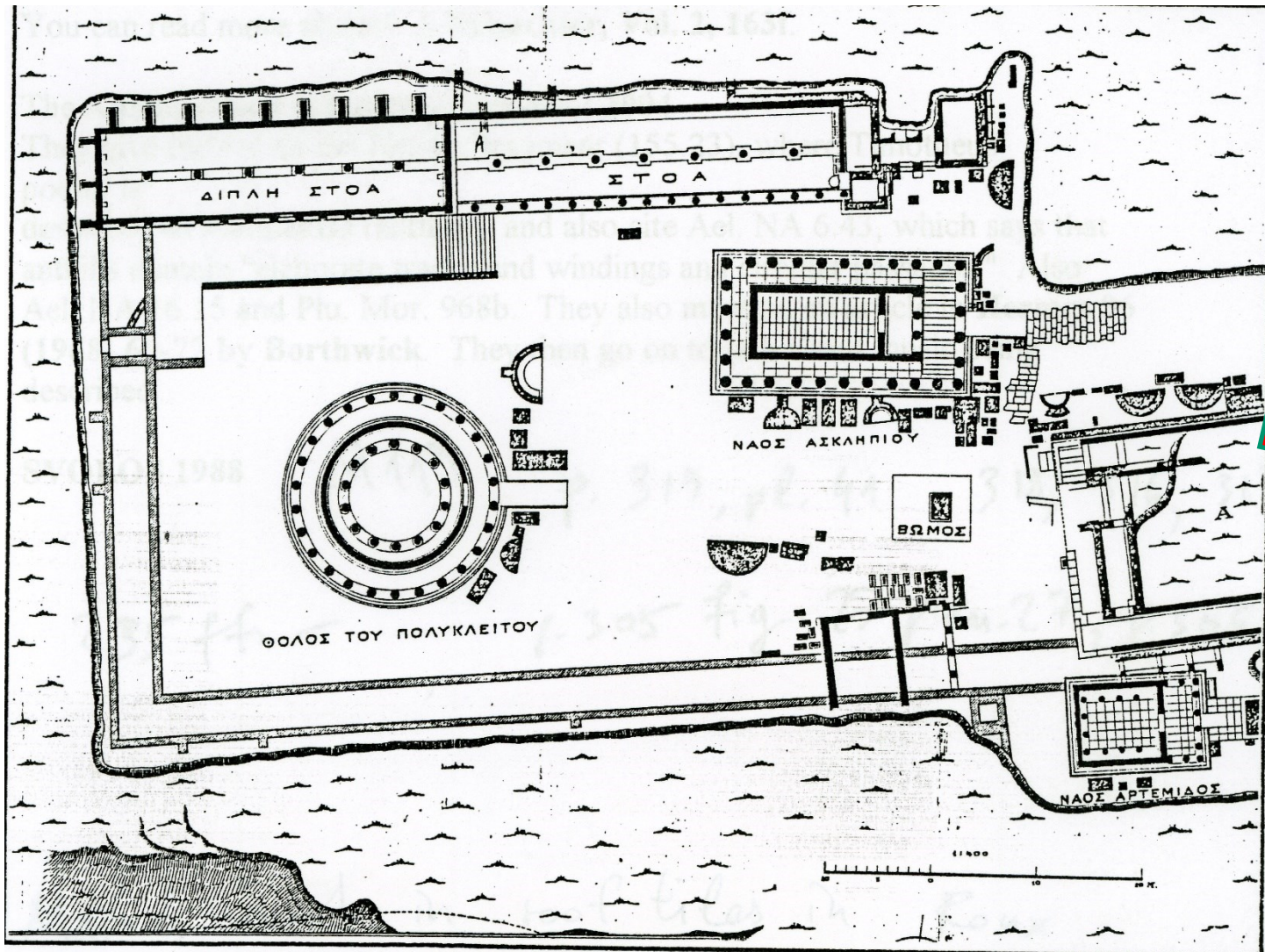

E



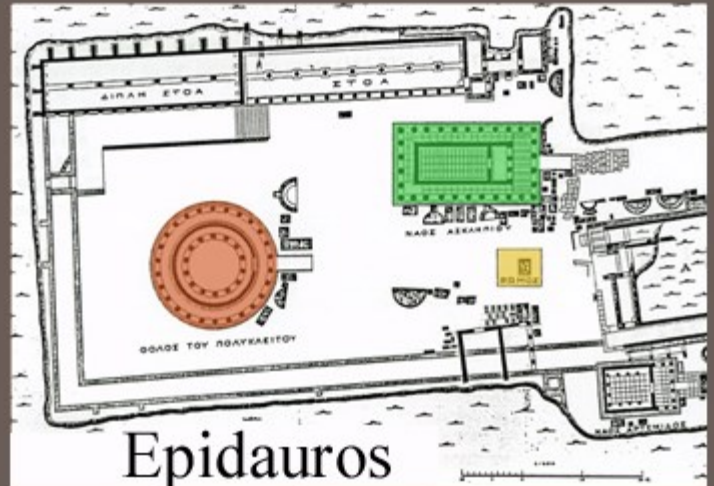
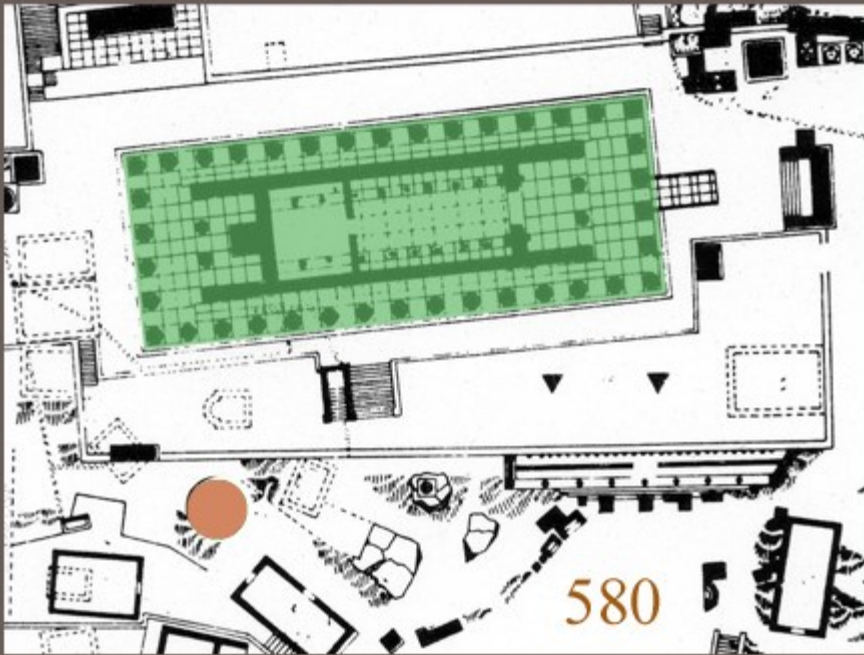

Epidaurus
360-330 ?

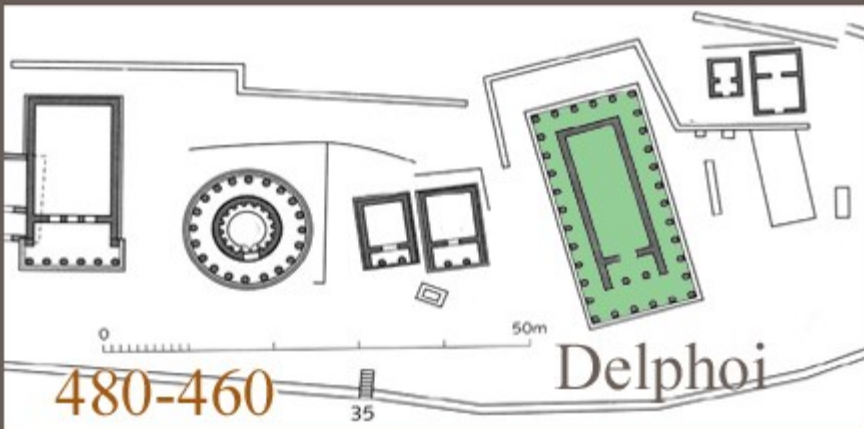

- Πασανίας 5.20.4: «ΕΣΤΙ ΕΝΤΟΣ ΤΗΣ ΑΛΤΕΩΣ...ΚΑΙ ΟΙΚΗΜΑ ΠΕΡΙΦΕΡΕΣ ΟΝΟΜΑΖΟΜΕΝΟΝ **ΦΙΛΙΠΠΕΙΟΝ**. ΕΠΙ ΚΟΡΥΦΗΝ ΔΕ ΕΣΤΙ ΤΟΥ ΦΙΛΙΠΠΕΙΟΥ **ΜΗΚΩΝ ΧΑΛΚΗ ΣΥΝΔΕΣΜΟΣ ΤΑΙΣ ΔΟΚΟΙΣ...**»

ΟΛΥΜΠΙΑ, THE PHILIPPEION

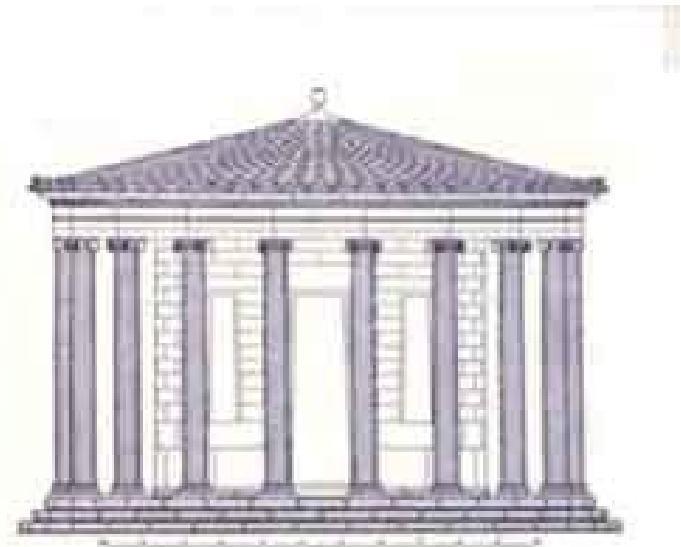
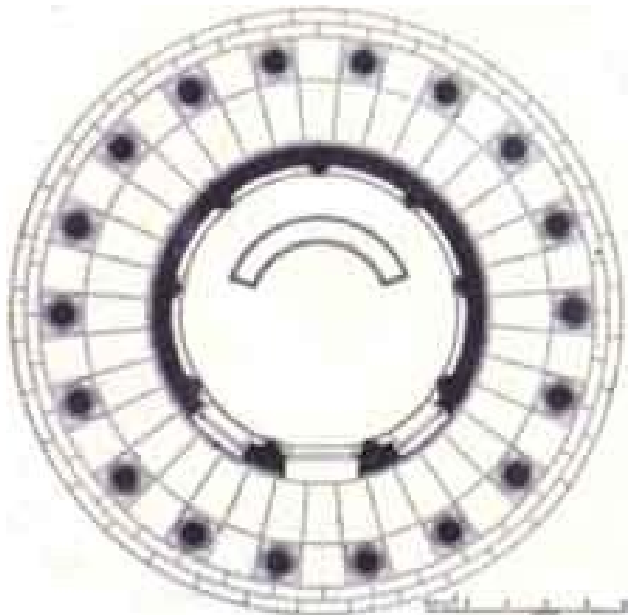

Macedonians' difficulty in understanding the Ionic Order. “barbaric”!!!



TEMPLE OF ATHENA, PRIENE

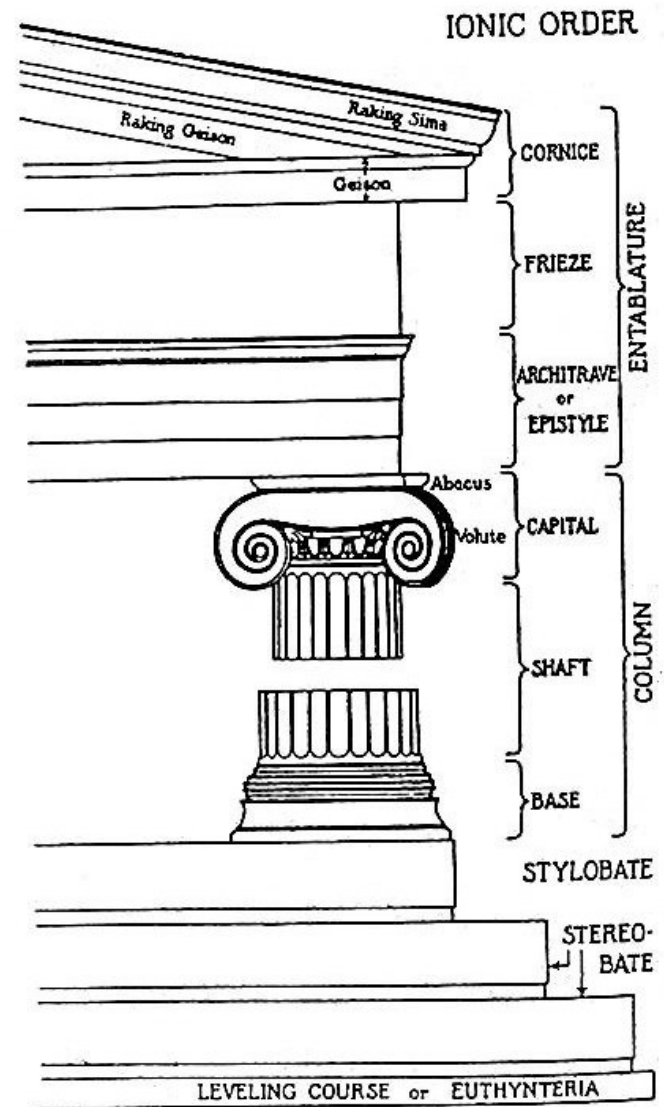
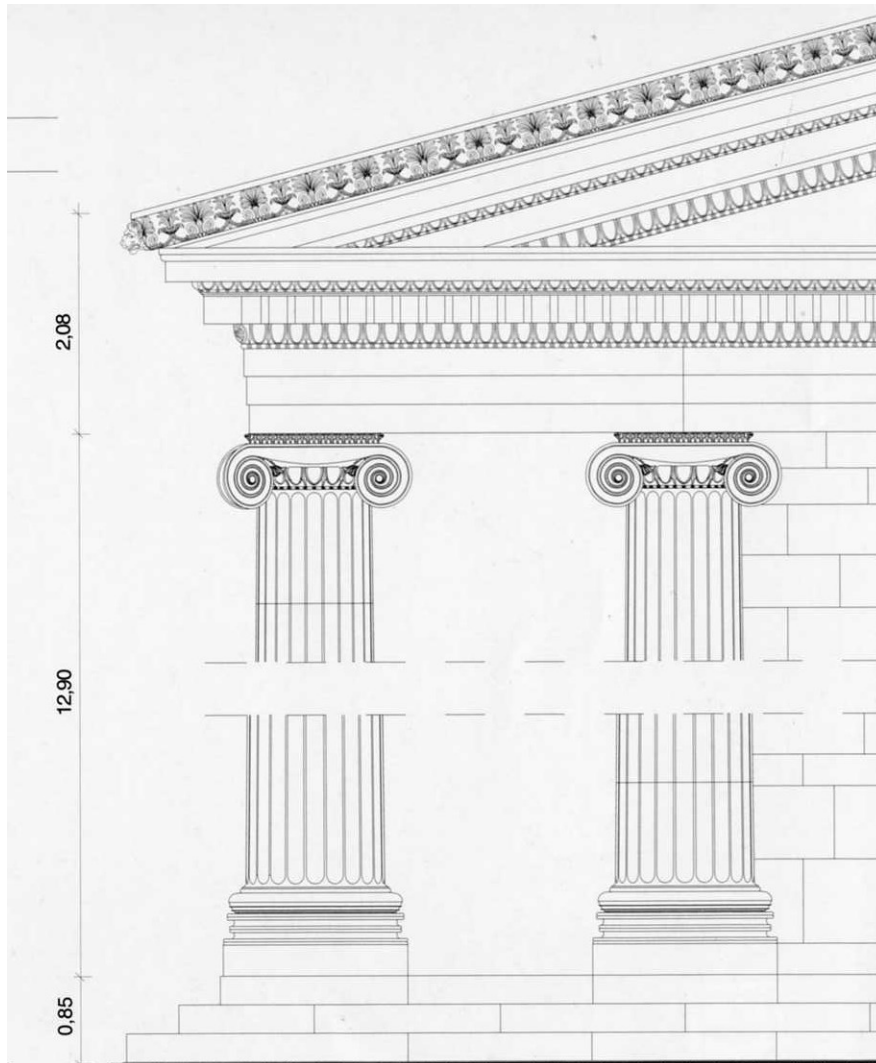



Townsend, R. 2003. "The Philippeion and Fourth Century Athenian Architecture." In *The Macedonians in Athens 322-229 B.C.*, edited by O. Palagia and S.V. Tracy, 93-101. Oxford: Oxbow.

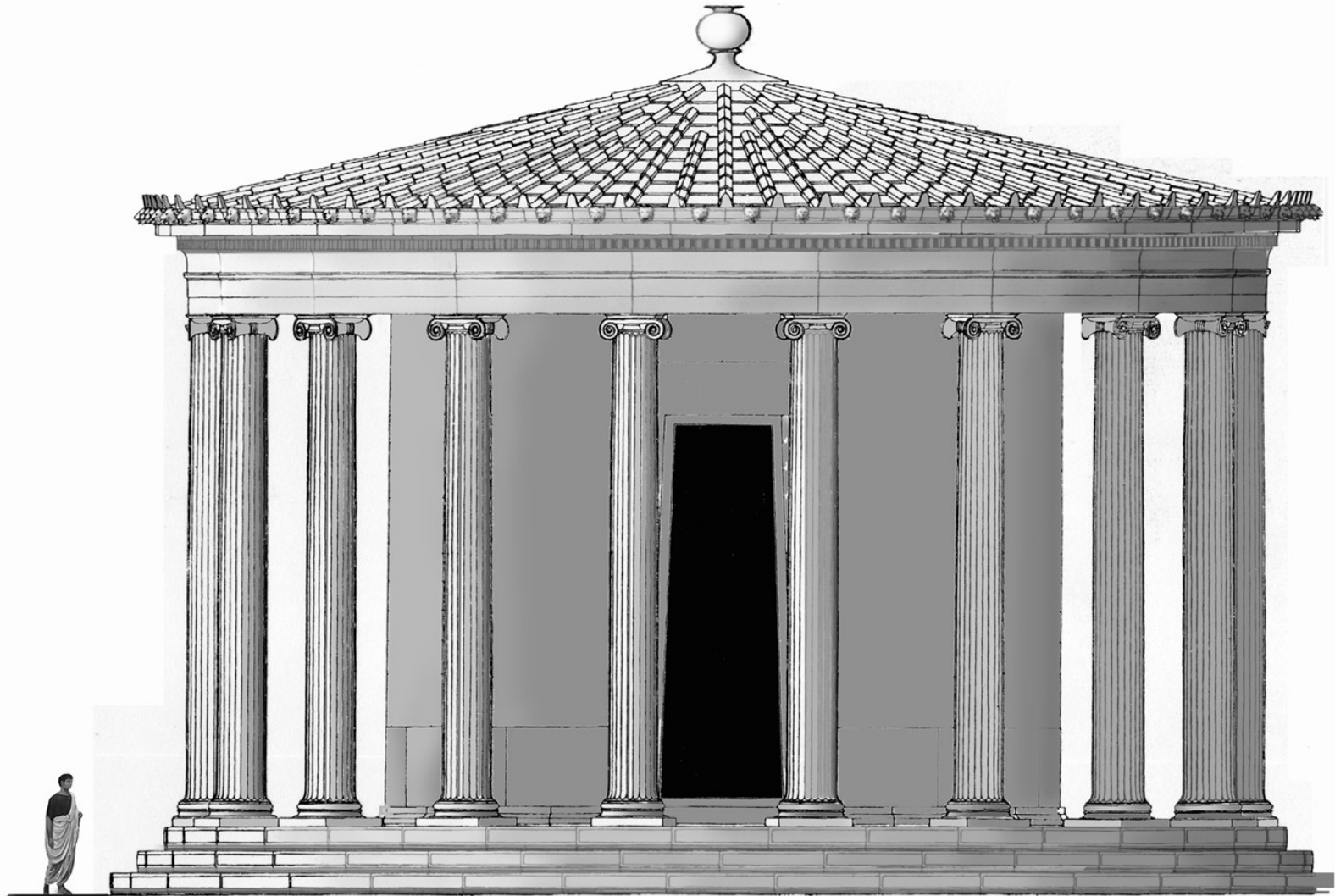

Ionic tholos with Corinthian columns in the interior

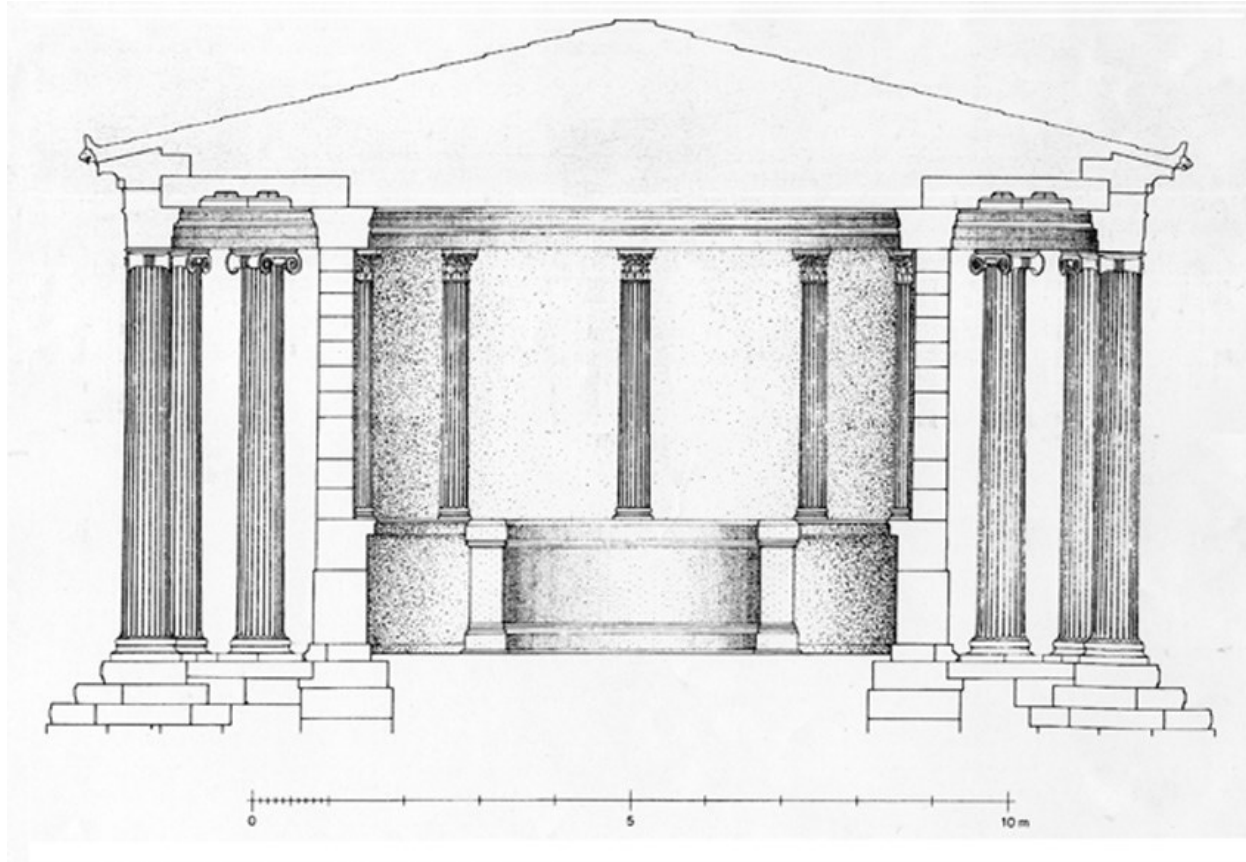

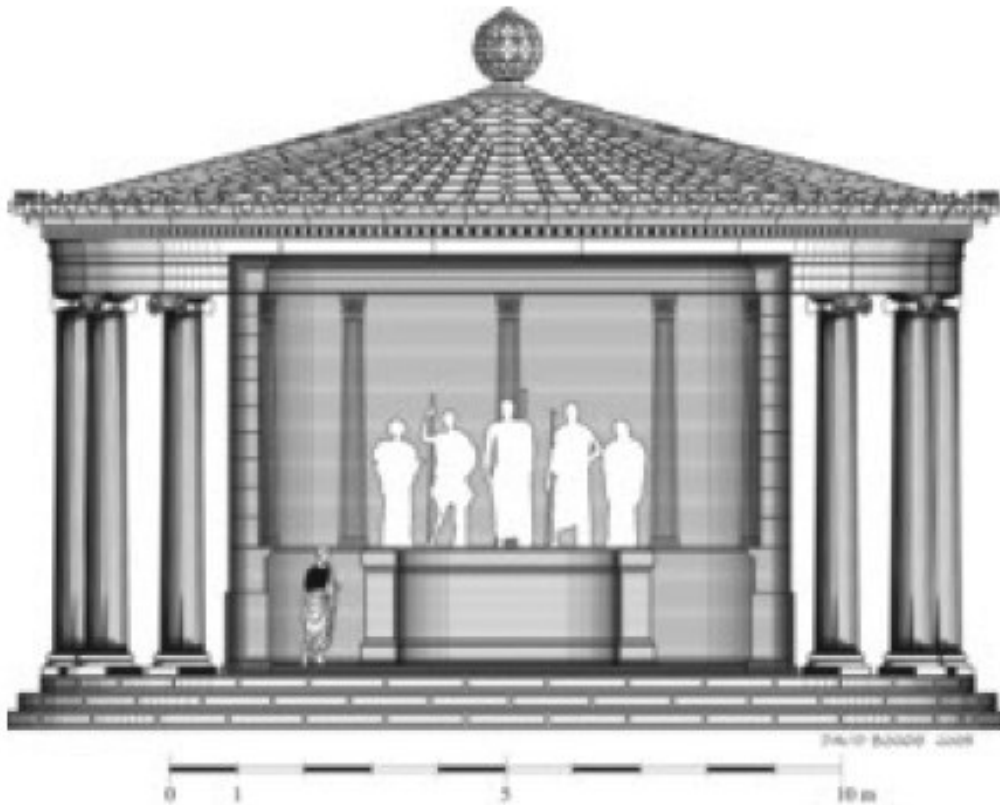
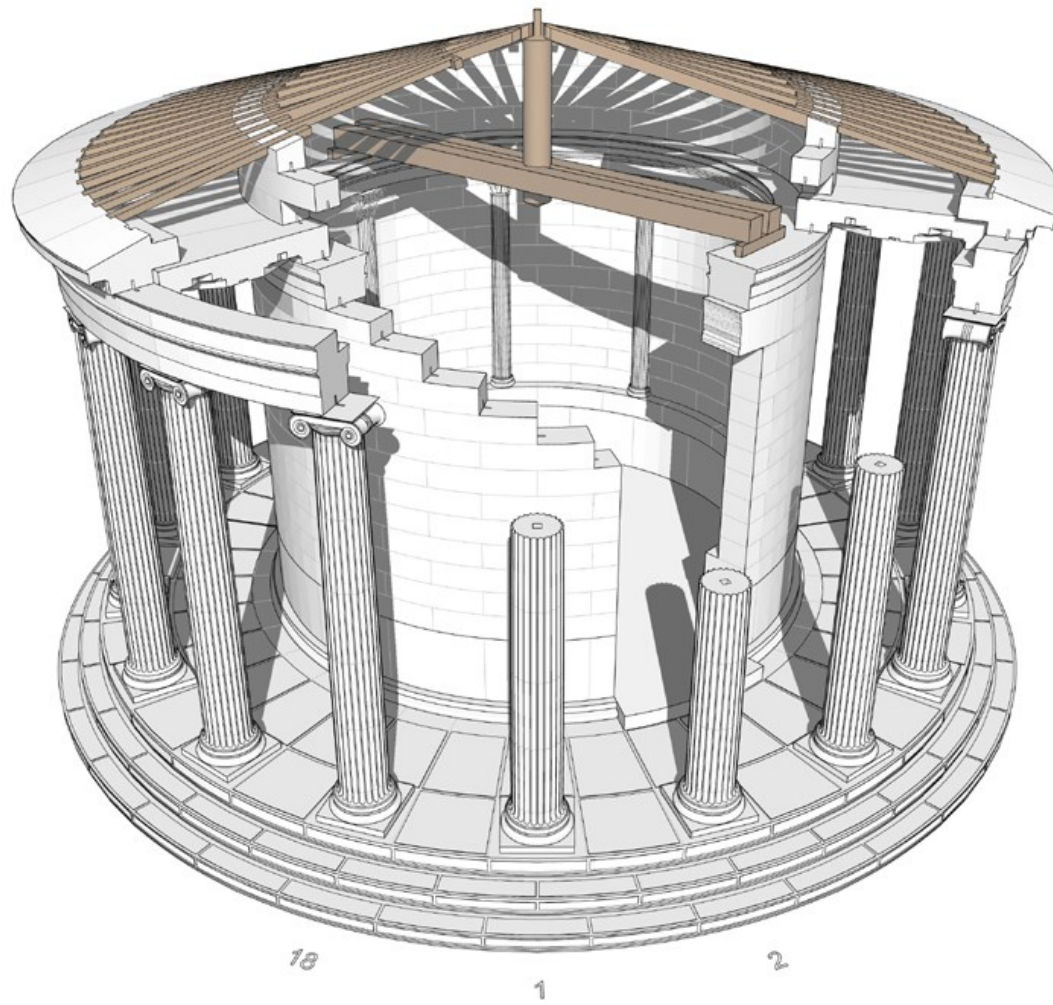

Fig. 6. Cut-away elevation of the Philippeion's interior incorporating some recent discoveries by Klaus Herrmann, Hajo van de Löcht and the author. (Drawing by David Boggs after Schlieff 1944)



10

1

2







LYSICRATES' THOLOS ATHENS



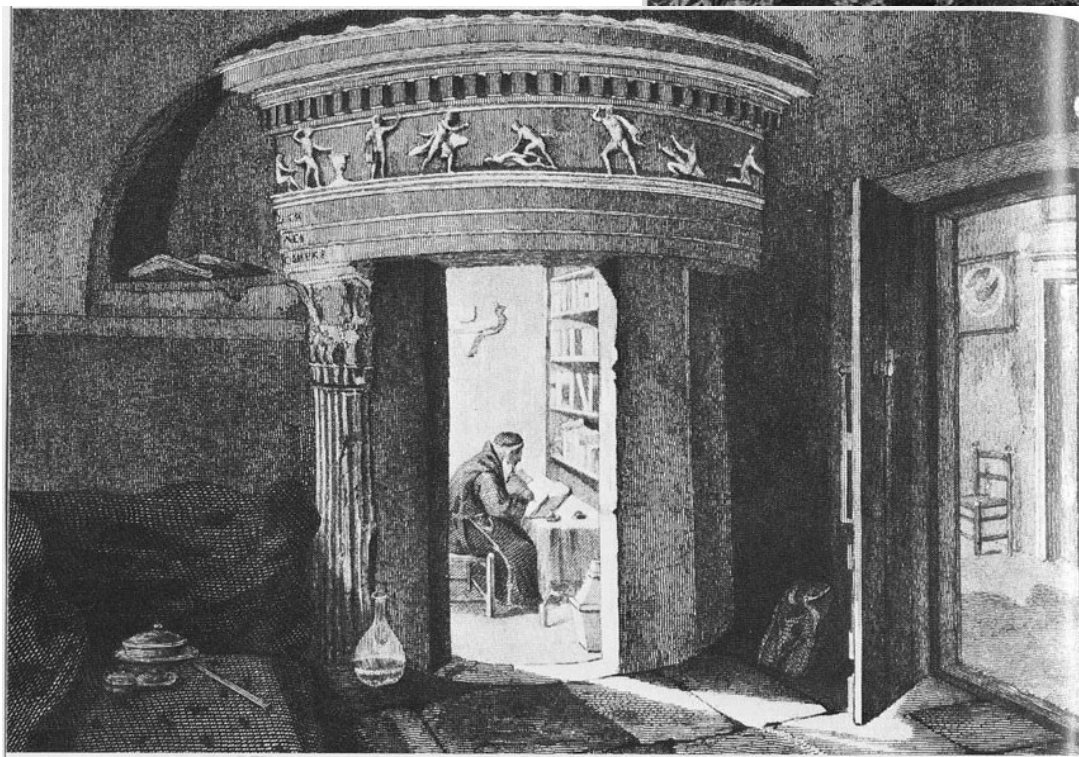
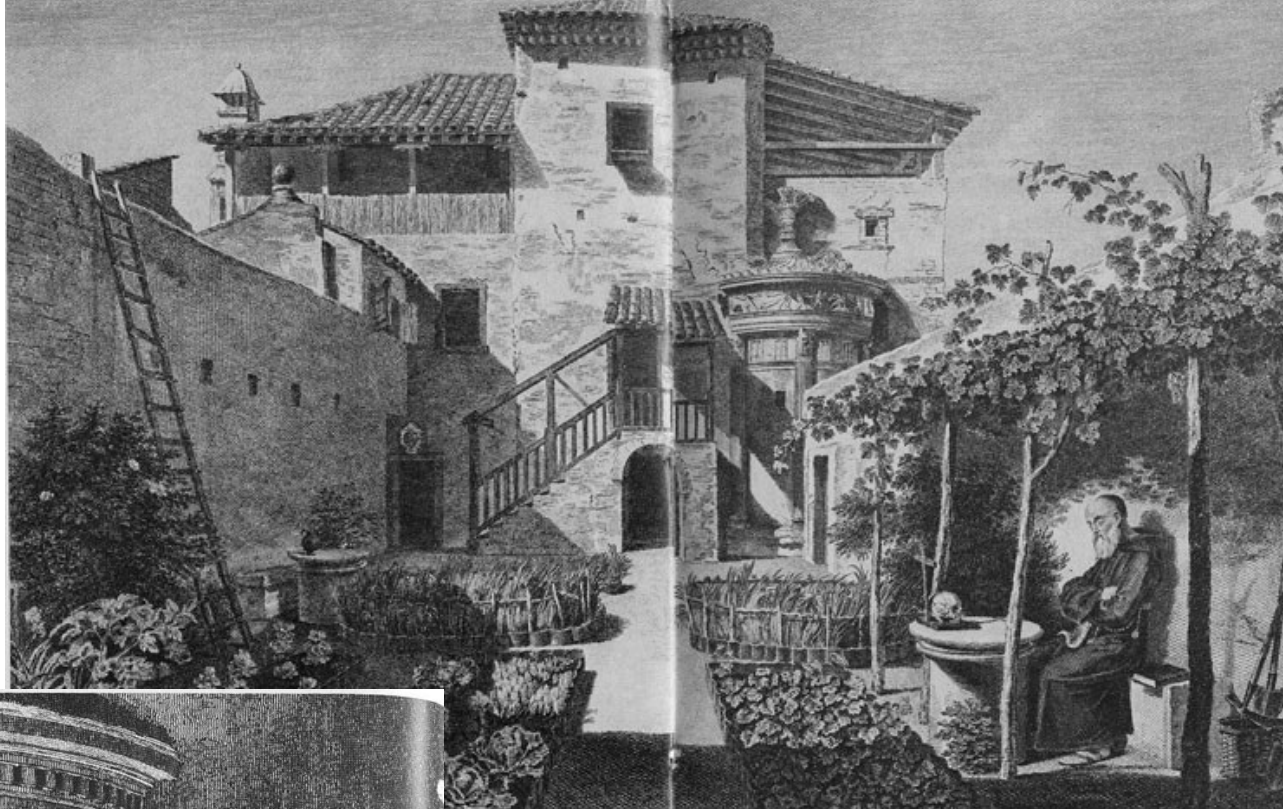







BLUE

white

white



