

ΙΑΤΡΙΚΗ ΦΥΣΙΚΗ

Π. Παπαγιάννης & Ε. Στυλιάρης
ΠΑΝΕΠΙΣΤΗΜΙΟΝ ΑΘΗΝΩΝ
2019 - 2020

Single Photon Emission Computed Tomography (SPECT)

- Αρχή Λειτουργίας της γ -Camera
- Ιδιότητες του Κατευθυντήρα (Διαπερατότητα, PSF)
- Προβολικές Λήψεις, Ανακατασκευή Τομογραφικής Εικόνας

Positron Emission Tomography (PET)

- Αρχή Λειτουργίας, Γεωμετρία Διάταξης
- Ανακατασκευή Τομογραφικής Εικόνας
- Time of Flight (ToF) PET

Ραδιοφάρμακα

Single Photon Emission CT (SPECT)

Ανίχνευση γ Ακτινοβολίας

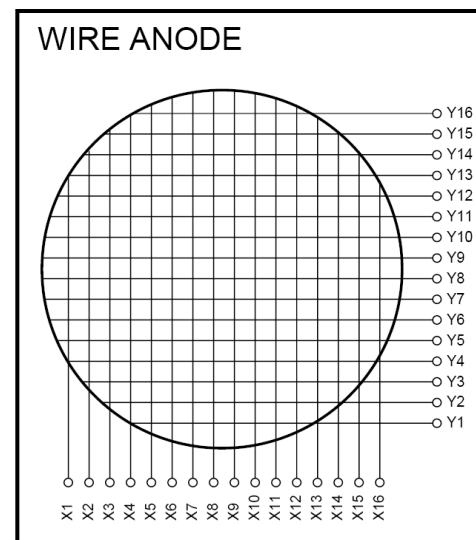
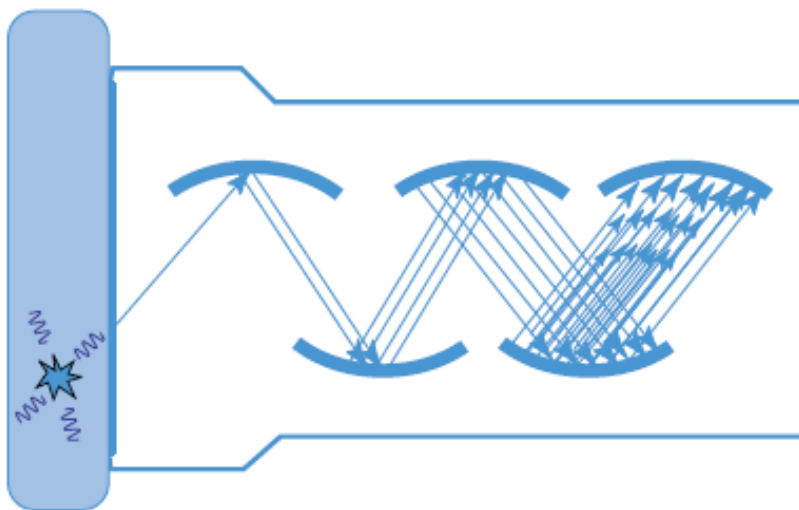
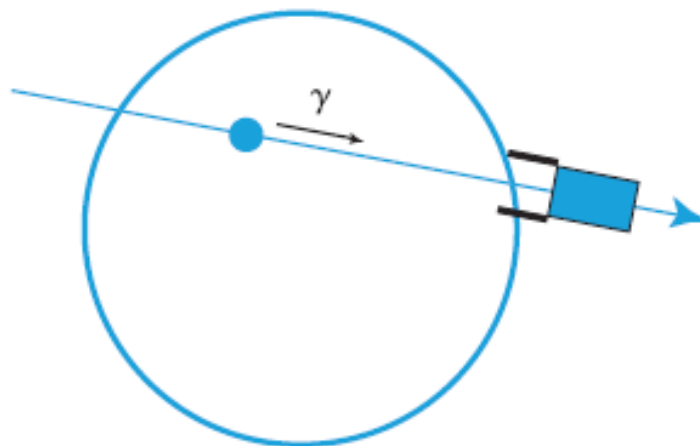

Single Photon Emission CT (SPECT)

From the Anger Camera to Position Sensitive Photomultiplier Tubes (PSPMTs)

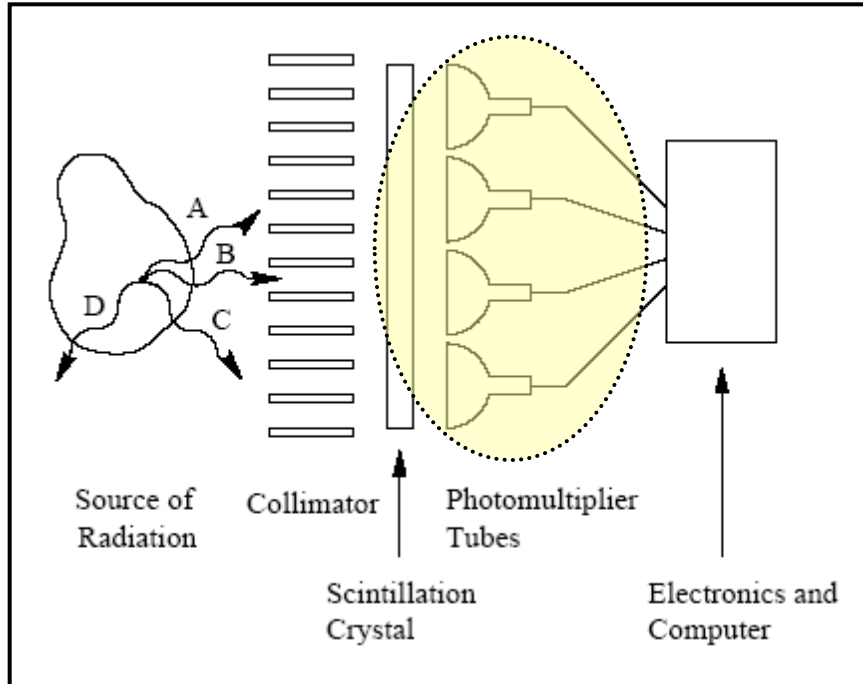

Anger Camera

H. Anger: "A new instrument for mapping gamma-ray emitters",
Biol. Med. Quart. Rep. UCRL (1957) 3653

Η συστοιχία των PMTs αντικαθίσταται από ένα πολυ-
ανοδικό πλέγμα.

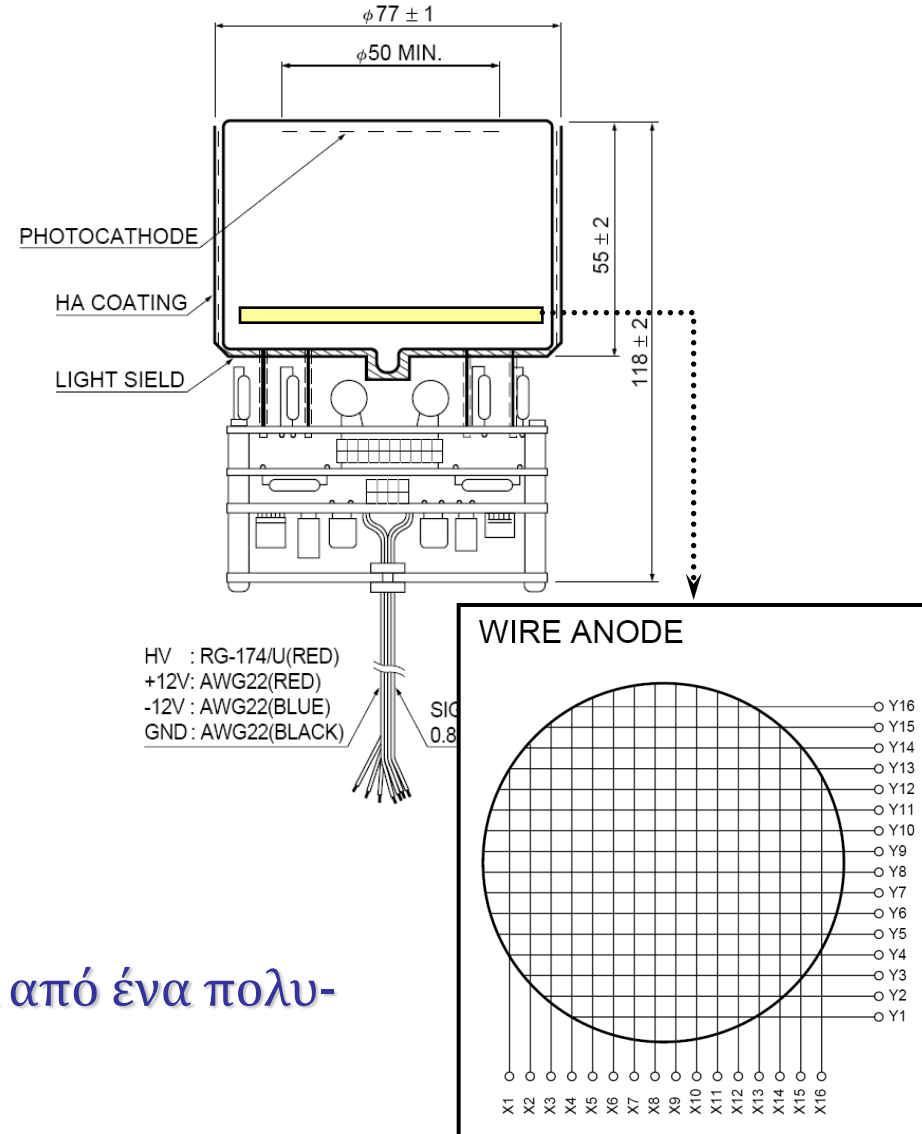

Single Photon Emission CT (SPECT)

Προσδιορισμός της θέσης σε χωρικά ευαίσθητους ανιχνευτές

$$X_{\text{pos}} = \frac{\sum_{i=1}^{N_x} X_i \cdot Q_i}{\sum_{i=1}^{N_x} Q_i}$$

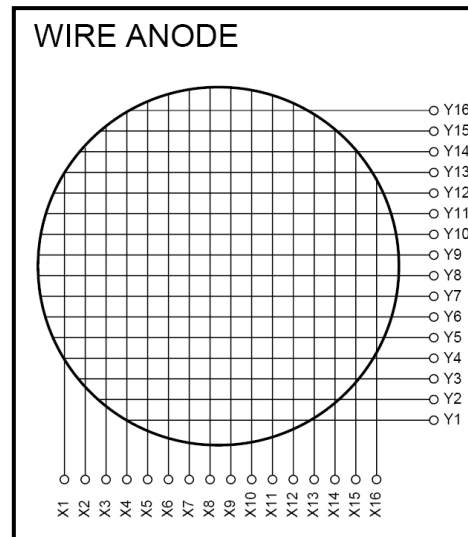

$$Y_{\text{pos}} = \frac{\sum_{i=1}^{N_y} Y_i \cdot Q_i}{\sum_{i=1}^{N_y} Q_i}$$

X_i : Οριζόντια θέση ανοδικού καλωδίου

Y_i : Κατακόρυφη θέση ανοδικού καλωδίου

Q_i : Ένταση μετρούμενου σήματος (φορτίο)

Μέθοδος του *κέντρου βάρους* ή τύπος του *Anger*

Single Photon Emission CT (SPECT)

Scintillator Technology

	NaI	BGO	GSO	LSO	LYSO	LGSO	LuAP	YAP	LaBr ₃
Light yield 10 ³ ph/MeV	38	9	8	30	32	16	12	17	60
Primary decay time	250	300	60	40	41	65	18	30	16
$\Delta E/E$ (%) at 662 keV	6	10	8	10	10	9	15	4.4	3
Density (g/cm ³)	3.67	7.13	6.71	7.35	7.19	6.5	8.34	5.5	5.08
Effective Z_{eff}	50	73	58	65	64	59	65	33	46
$1/\mu$ @511keV (mm)	25.9	11.2	15.0	12.3	12.6	14.3	11.0	21.3	22.3
PE (%)@511 keV	18	44	26	34	33	28	32	4.4	14

Πίνακας των κυριότερων υλικών που χρησιμοποιούνται σαν σπινθηριστές στην ανίχνευση γ -ακτινοβολίας.

NuPECC Nuclear Physics for Medicine (2014)

Single Photon Emission CT (SPECT)

Τεχνολογική εξέλιξη χωρικά ευαίσθητων φωτοπολλαπλασιαστών



First Generation
HAMAMATSU R2486
(crossed wire anode)



Second Generation
HAMAMATSU R8520
(crossed plate anode)

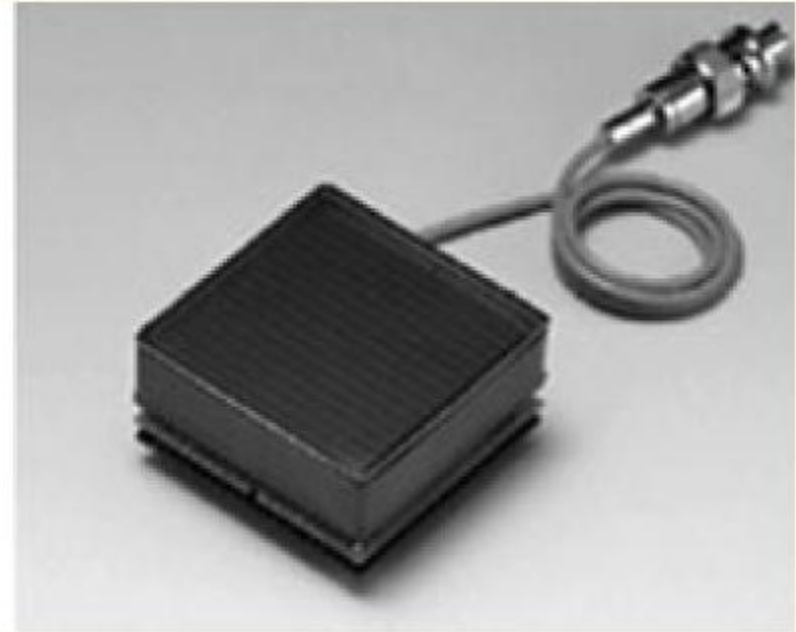

Third Generation
HAMAMATSU H13700
(multi anode structure)

Silicon Photo-Multipliers SiPMs

Single Photon Emission CT (SPECT)

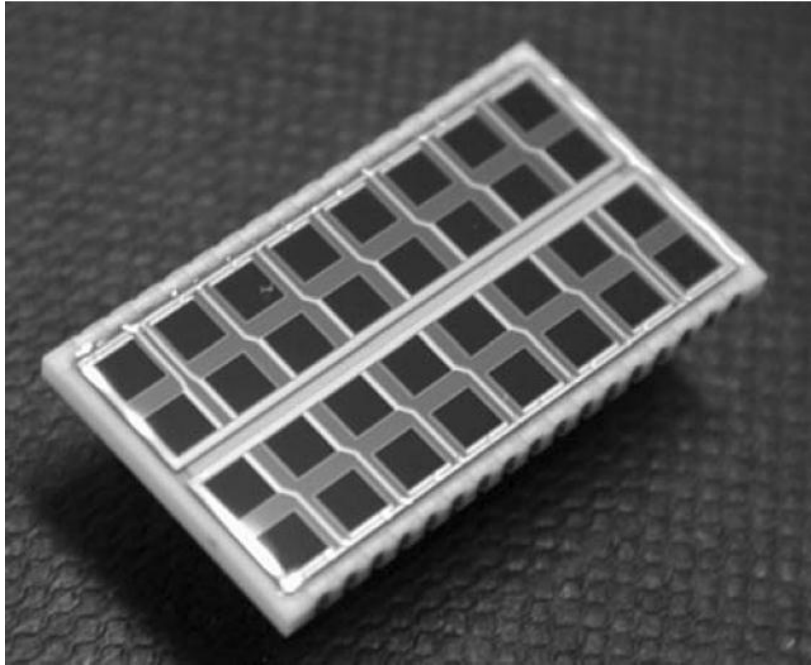

	PMT	APD	SiPM
Photon detection efficiency (PDE) in blue	20%	50%	20–70%
Gain	10^6	100	10^6
Bias voltage (V)	$\sim 1,000$	~ 400	< 100
Sensitivity in magnetic field	Yes	No	No
Rise time (ns)	~ 1	~ 5	~ 1

Πλεονεκτήματα φωτοδιόδων και SiPM έναντι των συμβατικών φωτοπολλαπλασιαστών.

Single Photon Emission CT (SPECT)

New Generation of SPECT-CT Systems

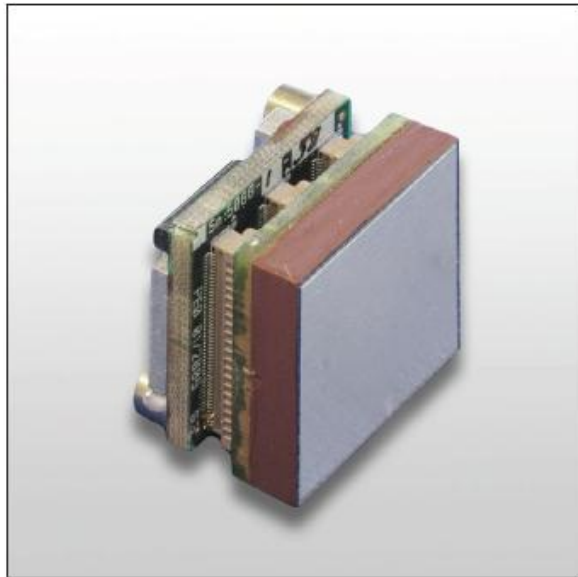

**Cadmium-Zinc-Telluride
(CZT)
Gamma Ray Detector Module**

- Room temperature operation.
- Gamma ray energy measurement up to 350keV or 700keV.
- $\leq 6\%$ FWHM energy resolution at 122keV.
- 256 pixels, each 1.6 x 1.6mm

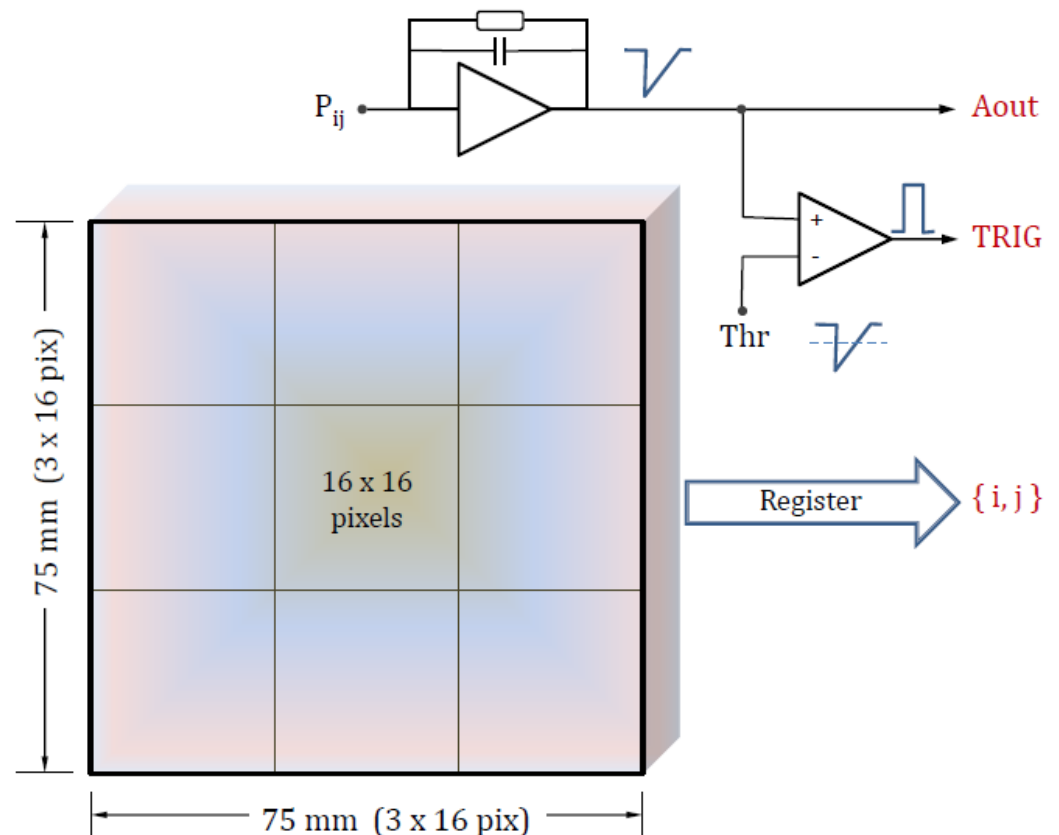

Single Photon Emission CT (SPECT)

Κατευθυντήρες / Collimators

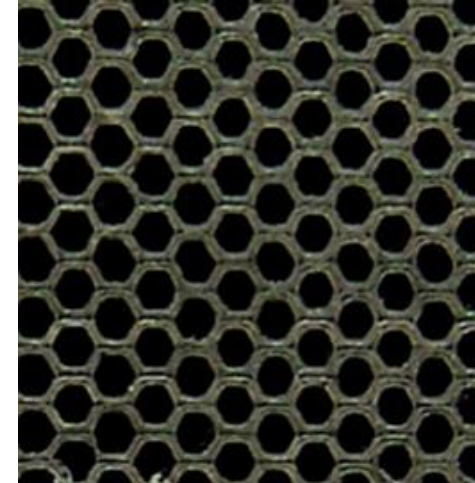
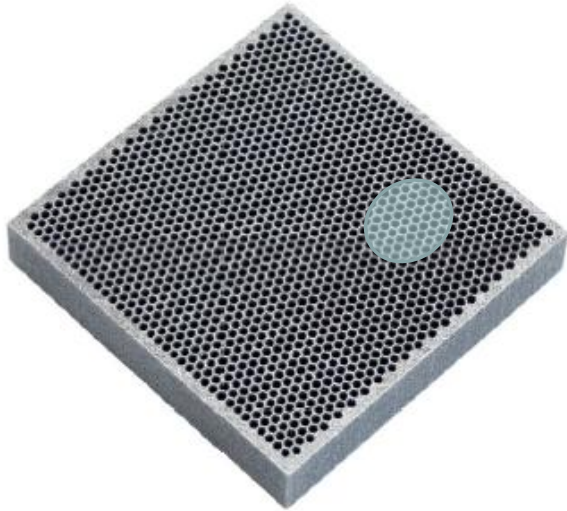

Κατευθυντήρας μολύβδου (Pb)
παράλληλων οπών,
εξαγωνικού τύπου

Total Area	$59.5 \times 60.4 \text{mm}^2$
Thickness	26.8 mm
Radius R of Circumscribed Circle	0.75 mm
Septum (Pb)	0.25 mm
Total Number of Holes along X (Nx)	32
Total Number of Holes along Y (Ny)	23

Η χρήση των κατευθυντήρων
καθίσταται αναγκαία για την
ευθυγράμμιση των γ-φωτονίων,
δεδομένου ότι αυτά δεν διαθλώνται
($n \approx 1$)

Single Photon Emission CT (SPECT)

Γεωμετρική Διαπερατότητα (Transmission) Κατευθυντήρα

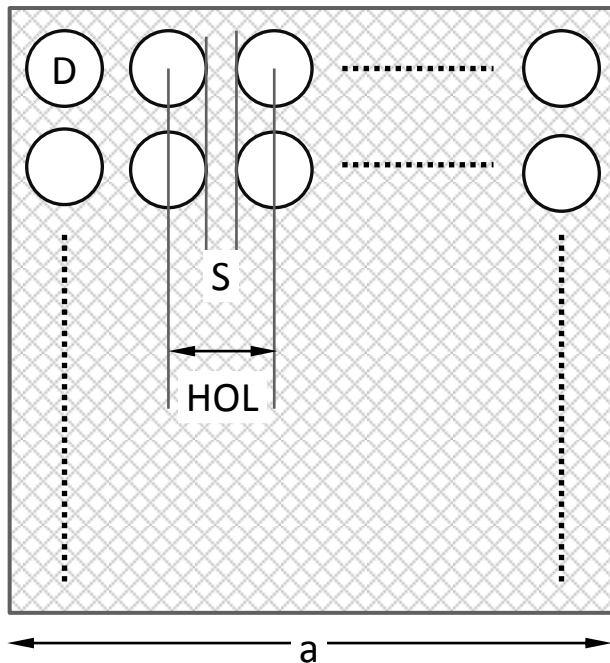

D : Διάμετρος οπής

S : Διαχωριστική απόσταση (Septum)

HOL : Απόσταση δύο διαδοχικών οπών

Γεωμετρική Διαπερατότητα

Είναι ο λόγος του εμβαδού της επιφάνειας των οπών προς την συνολική μετωπική επιφάνεια του κατευθυντήρα



$$T_r = \frac{S_{\text{Holes}}}{S_{\text{Total}}} = \frac{N^2 \cdot \frac{\pi D^2}{4}}{a^2} = \frac{\pi}{4} \cdot \frac{N^2 D^2}{N^2 \cdot HOL^2}$$



$$T_r = \frac{\pi}{4} \cdot \frac{D^2}{(D + S)^2}$$

Single Photon Emission CT (SPECT)

Point Spread Function (PSF)

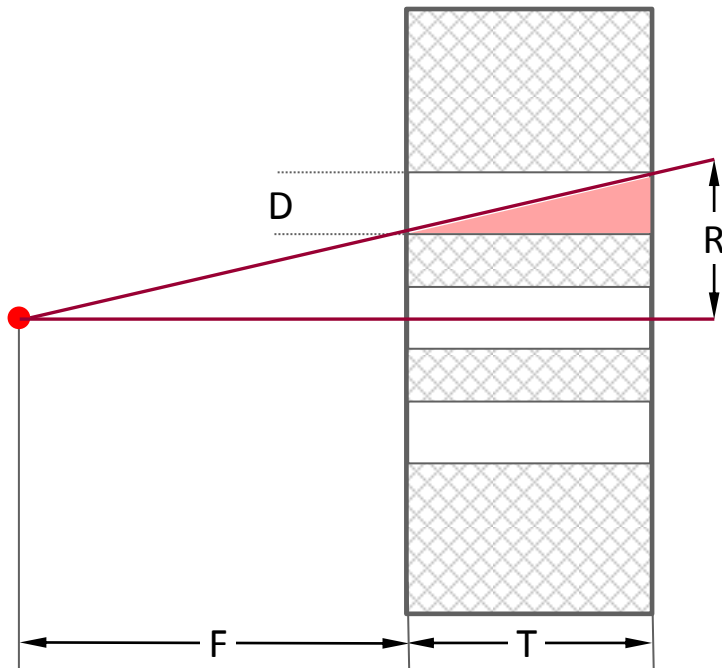

D: Διάμετρος οπής

T: Πάχος κατευθυντήρα

F: Απόσταση σημειακής πηγής από την μετώπη του κατευθυντήρα

Η σημειακή πηγή απεικονίζεται διάχυτα σαν κύκλος ακτίνας R

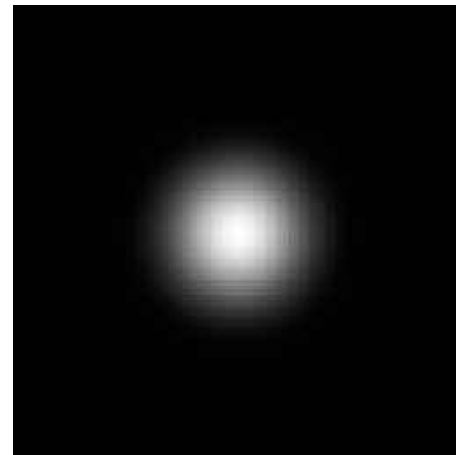

$$\frac{R}{F+T} = \frac{D}{T} \Rightarrow R = \frac{D}{T} \cdot (F+T)$$

Single Photon Emission CT (SPECT)

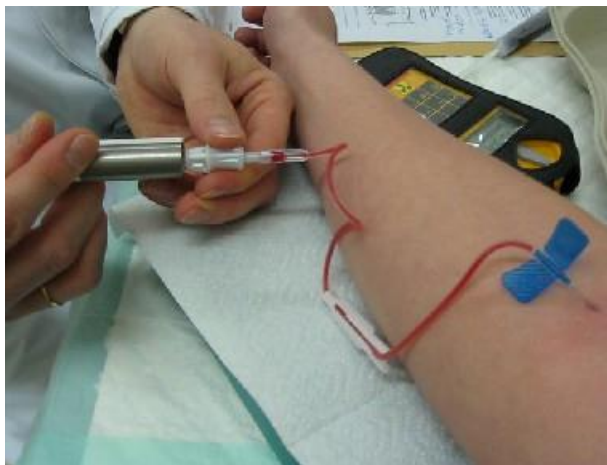
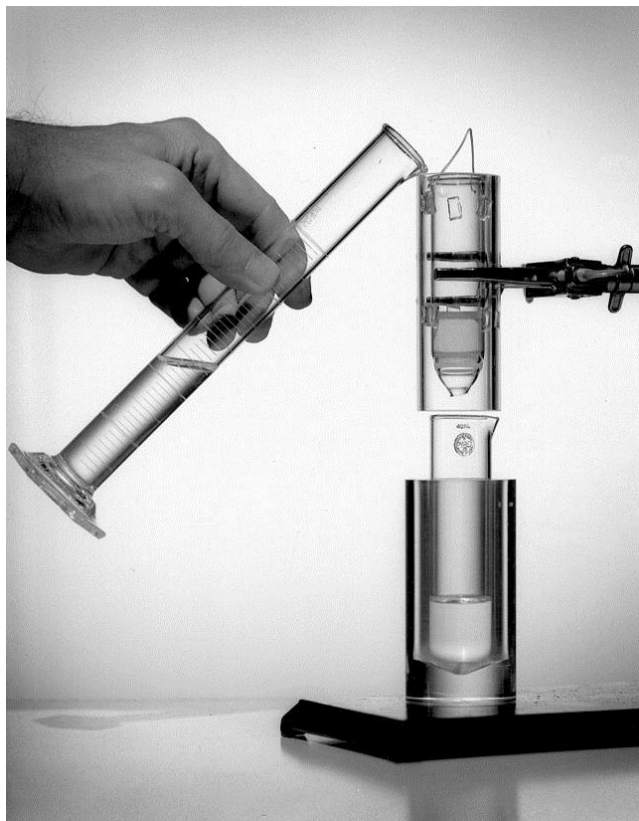

Ιχνηθέτηση με
ραδιοφάρμακο ^{99m}Tc

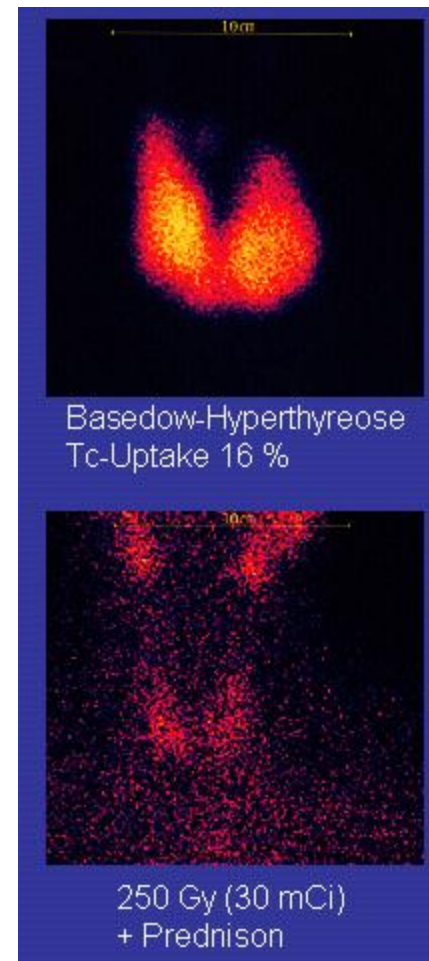
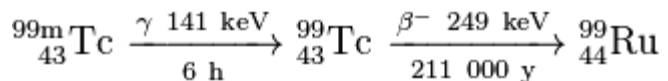

Παραγωγή ^{99m}Tc από την έκλυση ^{99}Mo και ενδοφλέβια χορήγηση.

Single Photon Emission CT (SPECT)



(a)

(b)



(a) γ -Camera καθώς και scanner τύπου SPECT δύο κεφαλών.

(b) Σύστημα τριών ανιχνευτικών κεφαλών. Η δυνατότητα περιστροφής της γ -Camera γύρω από τον ασθενή εξασφαλίζει τομογραφικές λήψεις SPECT.

Single Photon Emission CT (SPECT)

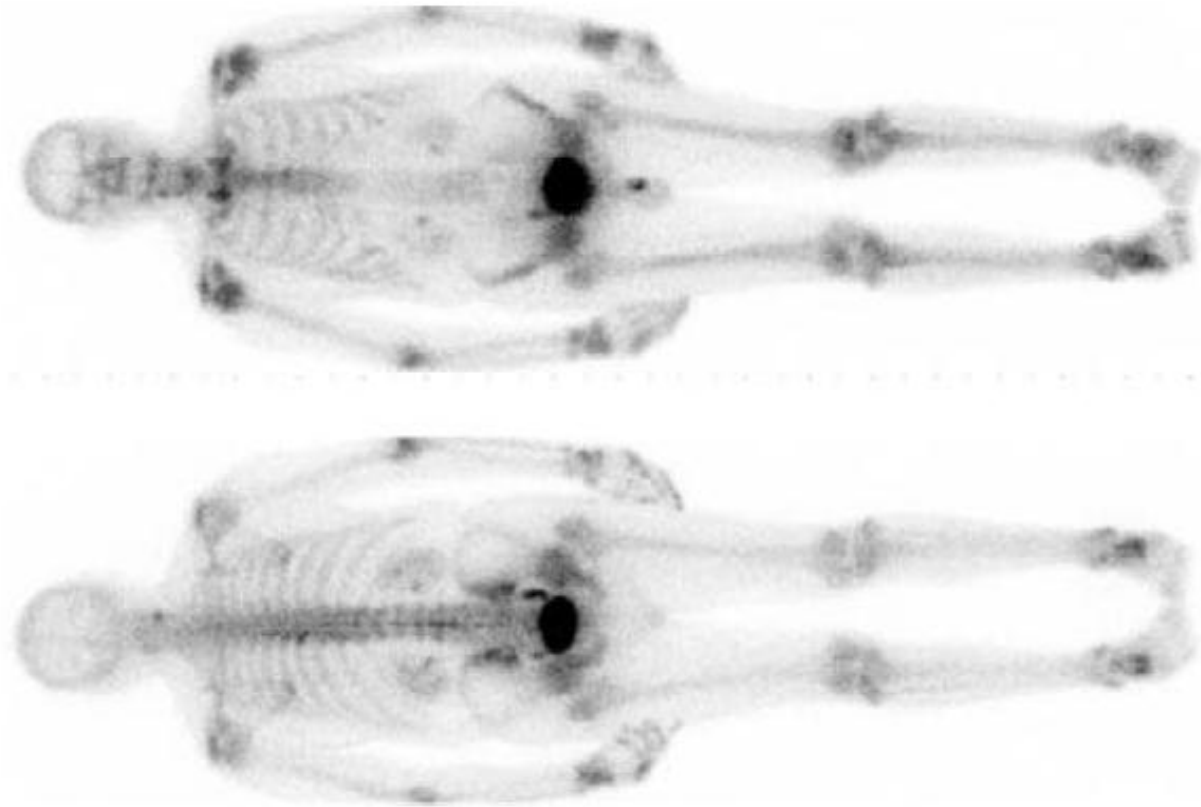

^{99m}Tc -MDP προβολική λήψη με γ -Camera διπλής κεφαλής. Το μέγεθος του ανιχνευτή είναι περίπου 40cm \times 50 cm. Οι ολόσωμες εικόνες ελήφθησαν με βραδεία μετακίνηση της κλίνης του ασθενούς. Η ουσία MDP συσσωρεύεται στα οστά, δίδοντας εικόνες αυξημένου μεταβολισμού. Λόγω της εξασθένησης, η σπονδυλική στήλη είναι καλύτερα ορατή στην κατώτερη, οπίσθια εικόνα.

SPECT / CT Dual Modality

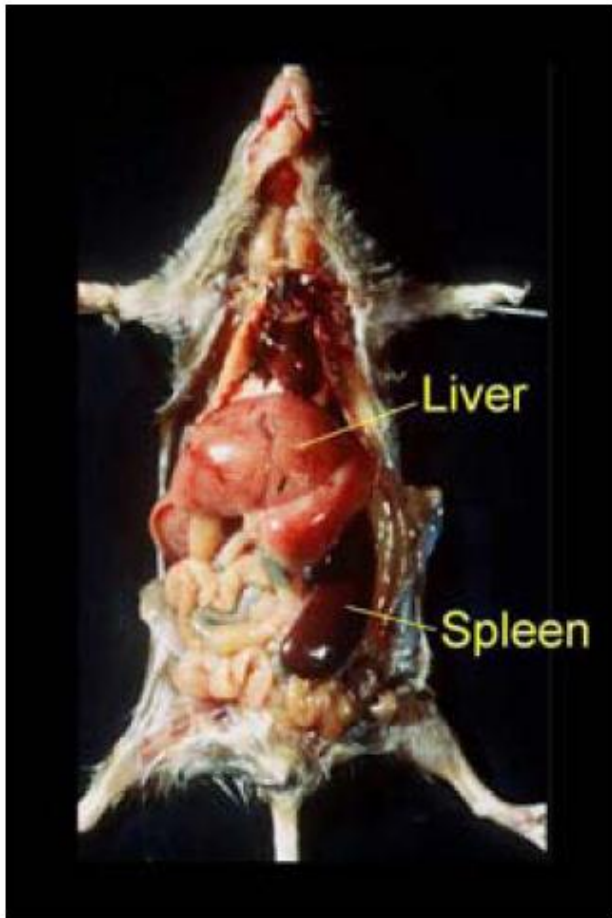

Mouse with AA-amyloidosis (left). Note the enlarged spleen and discoloration of the liver. Pseudo-colored SPECT image overlaid on top of co-registered CT image (top, right) and surface-rendered skeleton CT image (bottom, right). Bright object (high specific activity) is splenic amyloid, while cloudy object represents liver deposits.

Small Animal SPECT

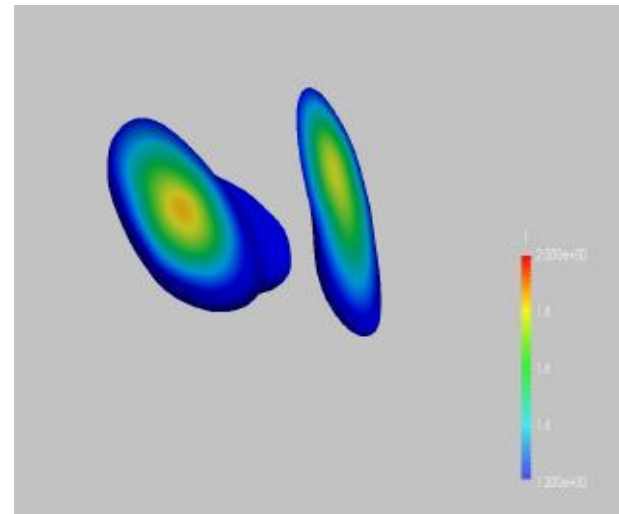
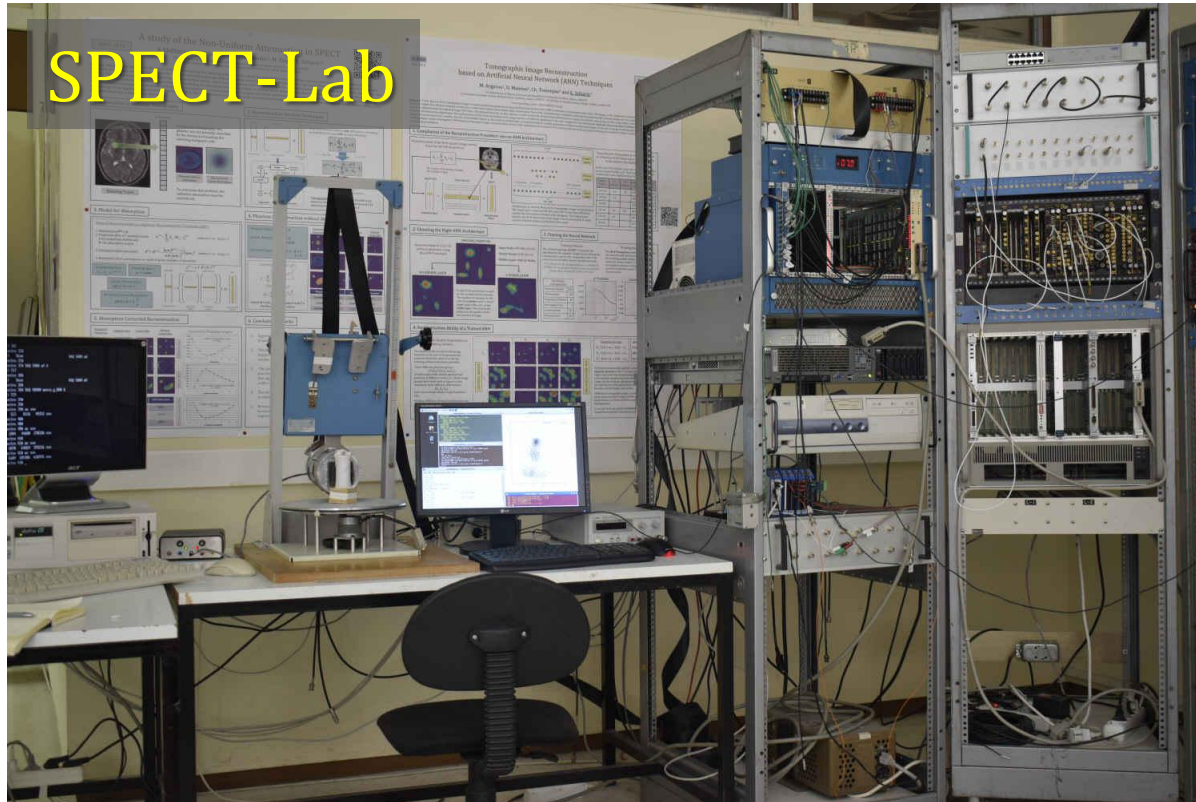

Techneium-labeled Diethylene-Triamine-Penta-Acetic (^{99m}Tc -**DTPA**) agent was administrated in a small mice and imaged with the high resolution γ -Camera system at SPECT-Lab, Athens, in order to evaluate the function of **kidneys**.

L. Koutsantonis, PhD Thesis (2018) The Cyprus Institute

Small Animal SPECT

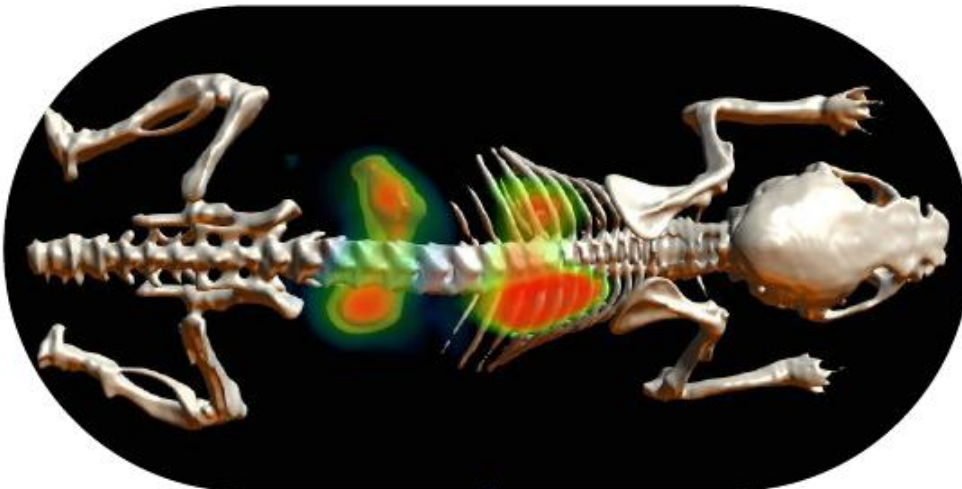
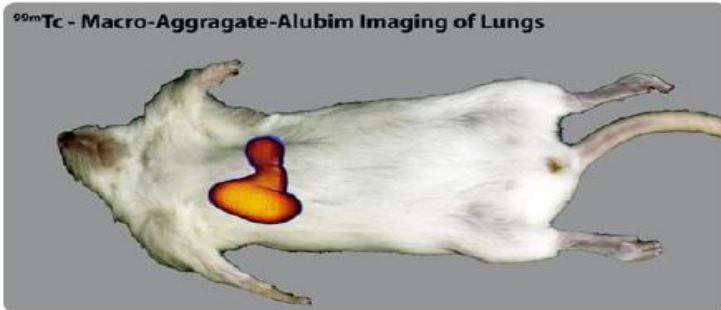

Two ex-vivo studies:

A. Tc^{99m} – Macro Aggregated Albumin (MAA) Imaging:

- Lung perfusion imaging
- Dose: **20 μ Ci**
- **24** projections in the full angular range
- Imaged 12h post injection

B. Tc^{99m} - Diethylene Triamine Penta Acid (DTPA) Imaging:

- Kidneys renal functionality
 - Dose: **30 μ Ci**
 - **24** projections in the full angular range
- Imaged 2h post injection

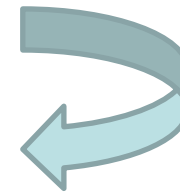

Positron Emission Tomography (PET)

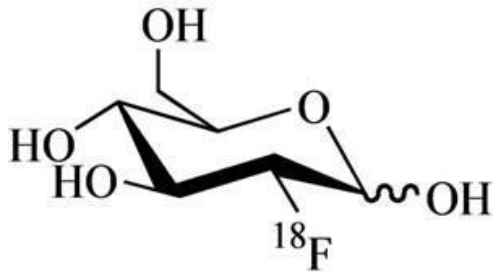

Radioactive derivative of the 2-deoxy-D-glucose labelled with the β^+ isotope ^{18}F .



Positron emission and positron-electron annihilation

PET scanner

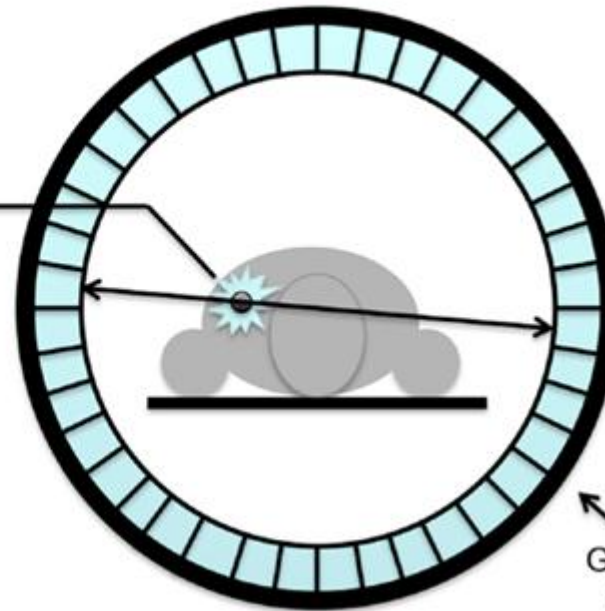
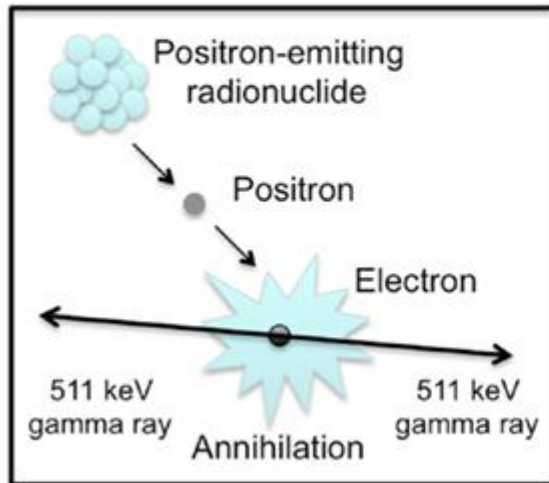

The two 511-keV γ -rays are emitted back-to-back

Gamma ray detectors

Positron Emission Tomography (PET)

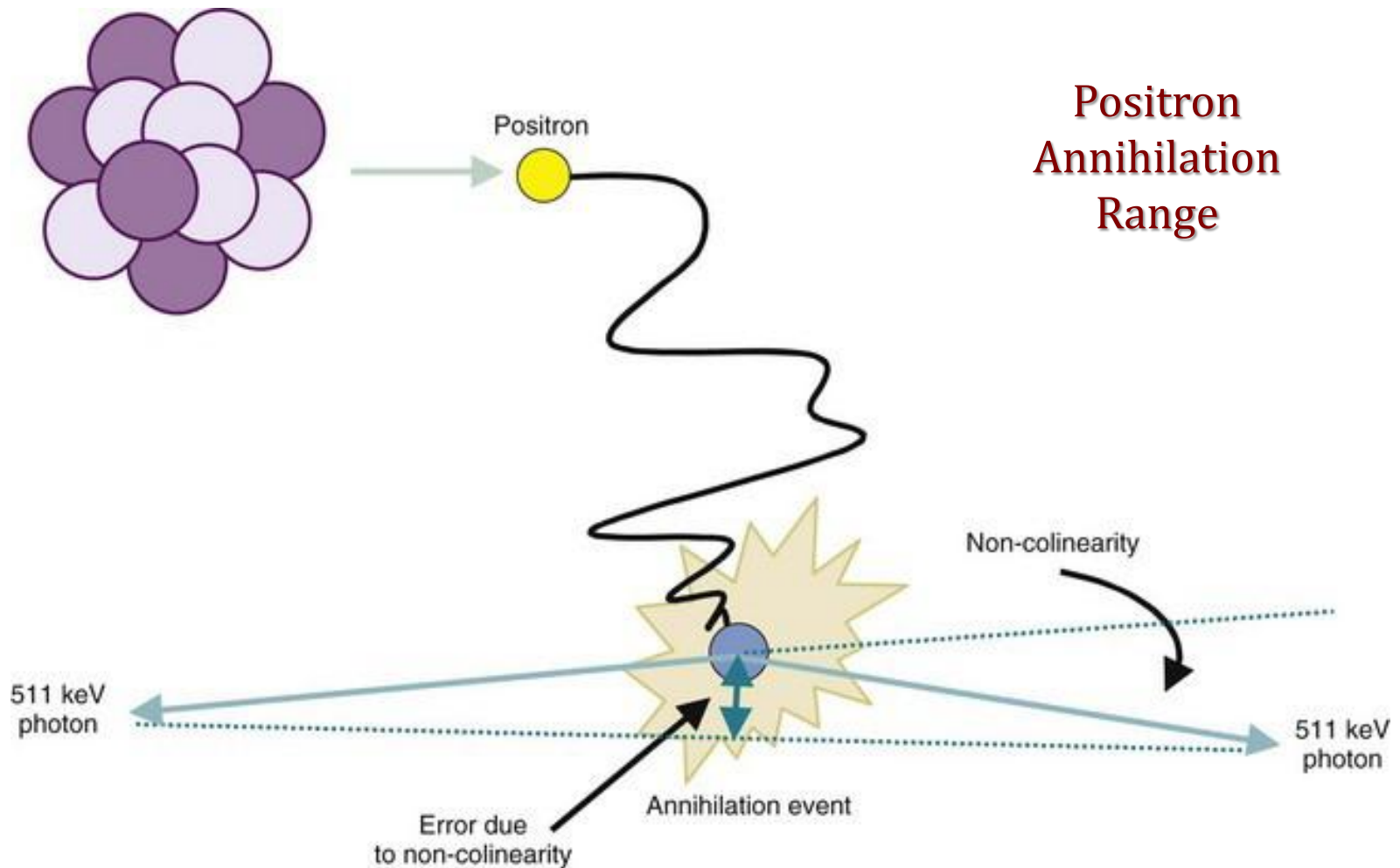

The finite positron range and the **non-collinearity** of the annihilation photons give rise to an inherent positional inaccuracy.

Positron Emission Tomography (PET)

Radionuclide	Half-life (minutes)	Radiotracer	Clinical applications
^{18}F	109.7	^{18}F FDG	oncology, inflammation, cardiac viability
^{11}C	20.4	^{11}C -palmitate	cardiac metabolism
^{15}O	2.07	H_2^{15}O	cerebral blood flow
^{13}N	9.96	^{13}N NH_3	cardiac blood flow
^{82}Rb	1.27	$^{82}\text{RbCl}_2$	cardiac perfusion

Radionuclide	$E(\beta^+)_{\text{max}}$ [keV]
^{18}F	635
^{11}C	970
^{13}N	1190
^{15}O	1720
^{82}Rb	3180

Positron Emission Tomography (PET)

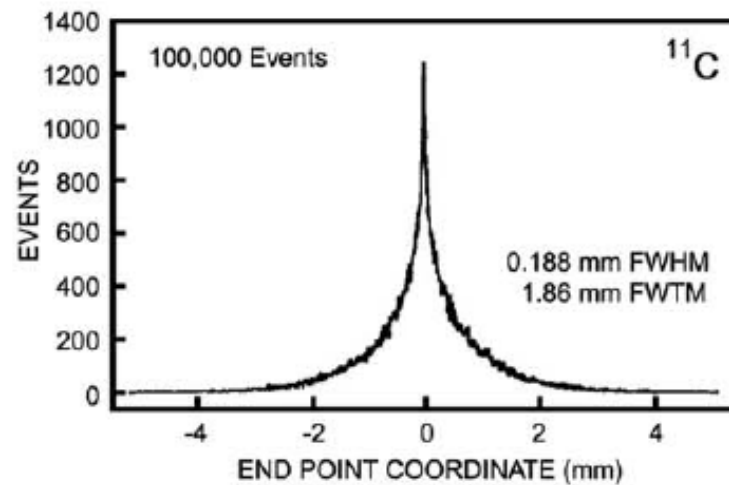
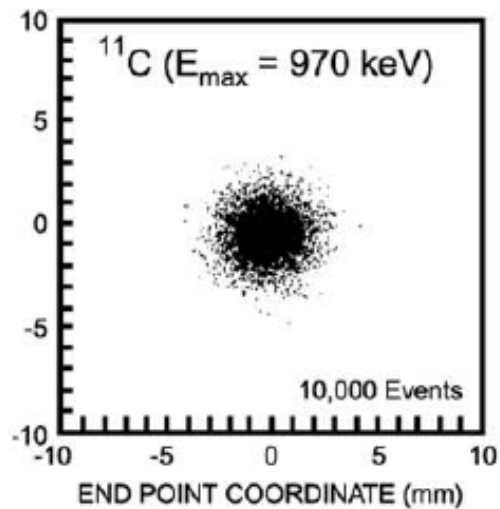
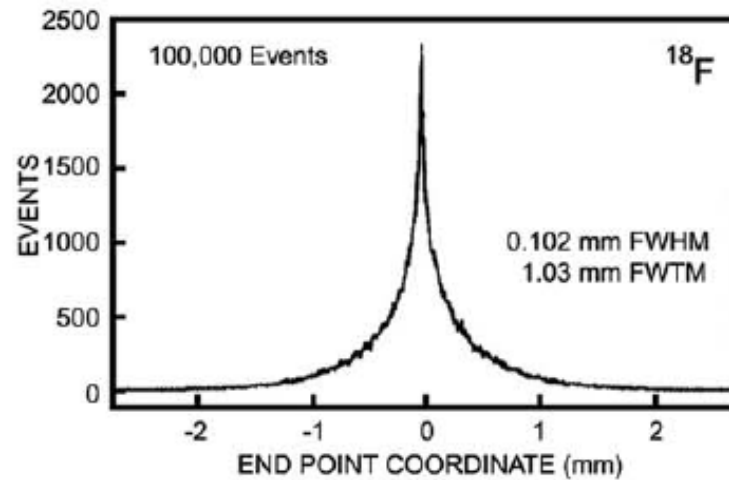
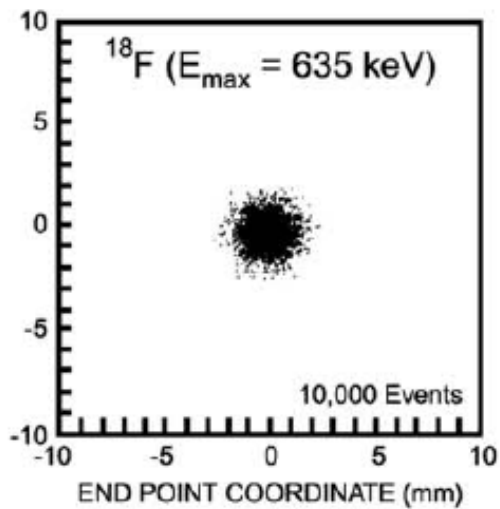

Positron Emission Tomography (PET)

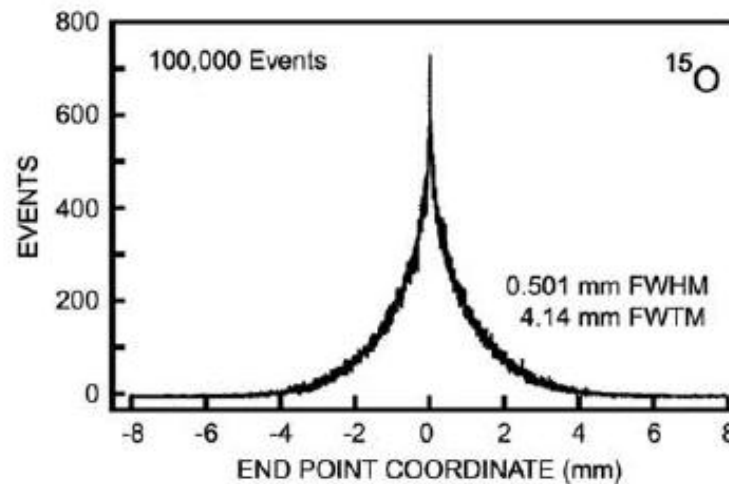
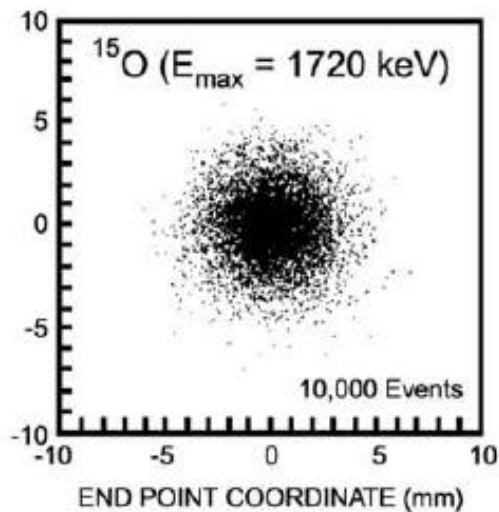
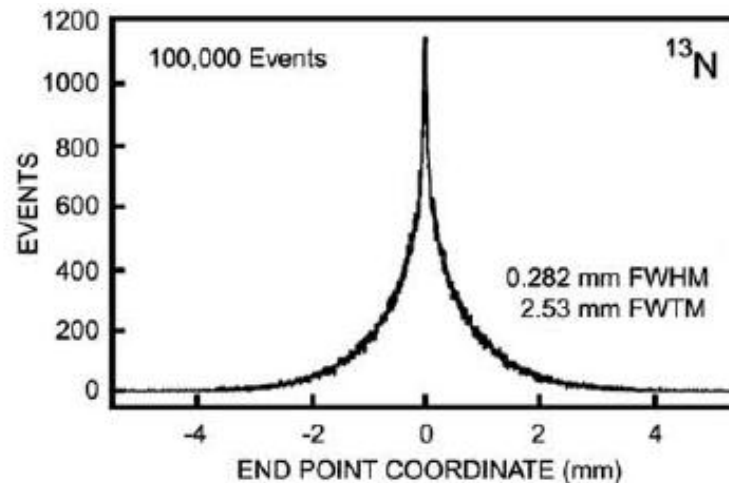
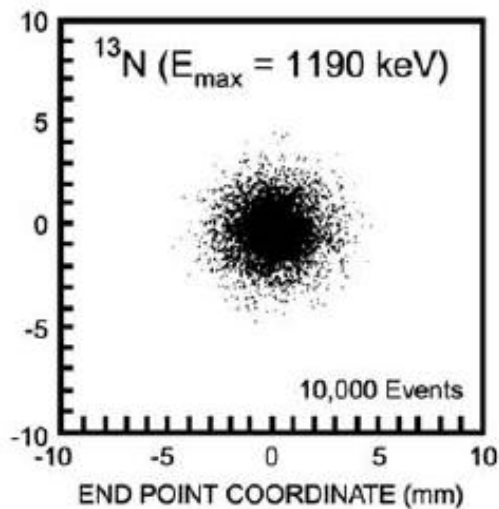

Positron Emission Tomography (PET)

Line of Response (LoR)

Η ευθεία που ενώνει δύο συσχετισμένα στοιχεία του ανιχνευτή όπου έχουν καταγραφεί τα δύο φωτόνια της εξαύλωσης (511keV).

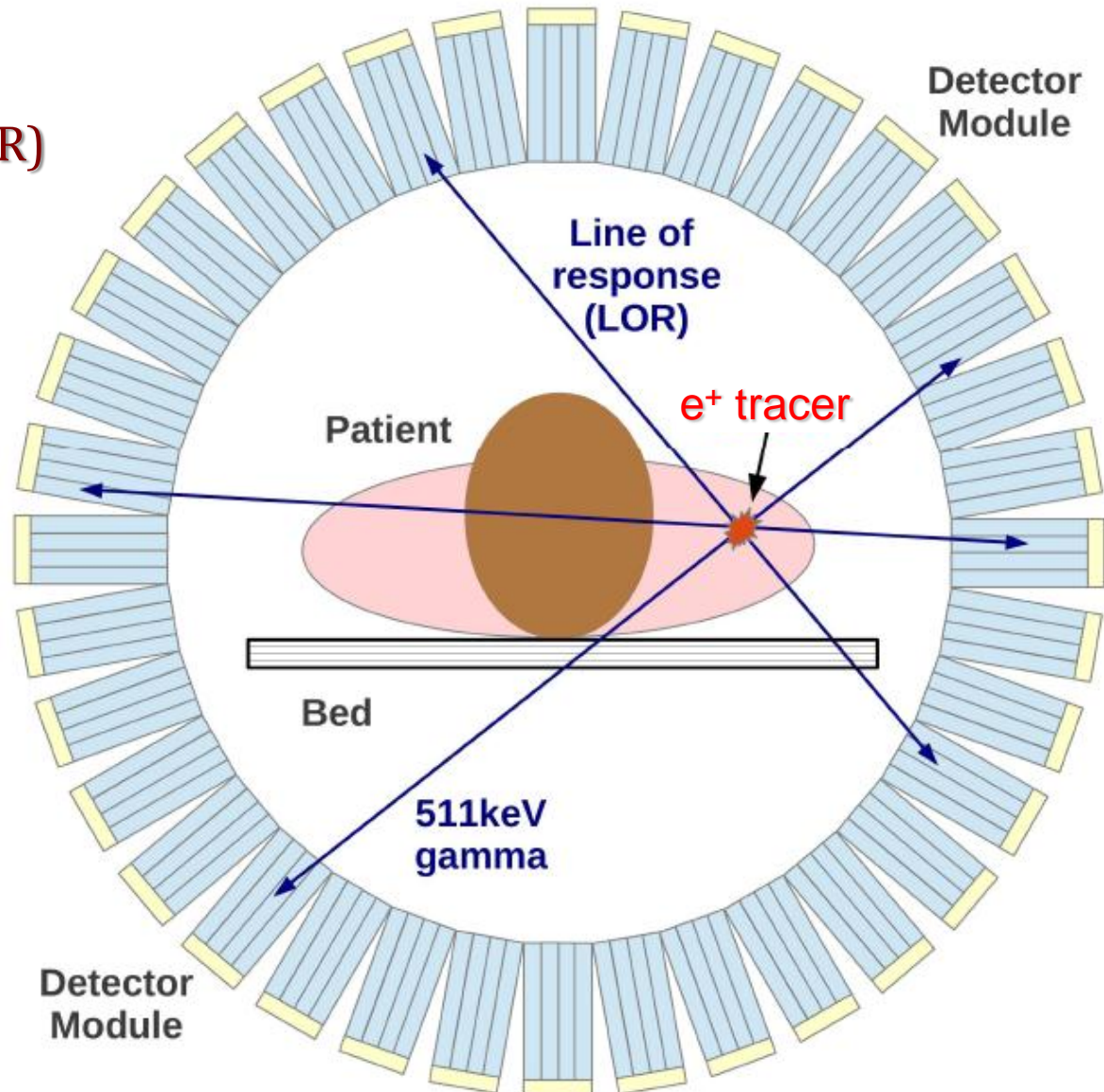

Positron Emission Tomography (PET)

True Coincidence

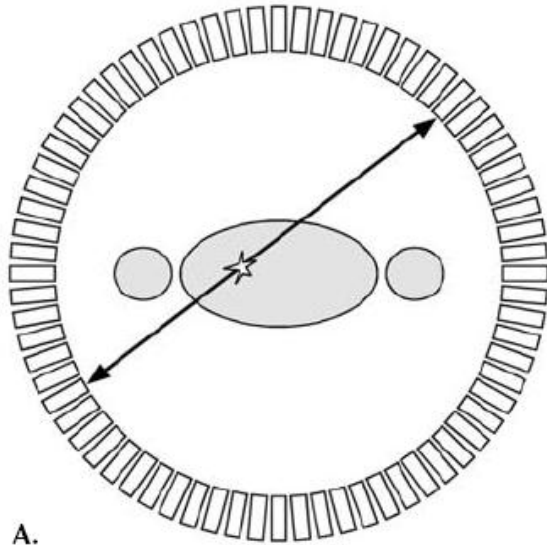

A.

Scattered Coincidence

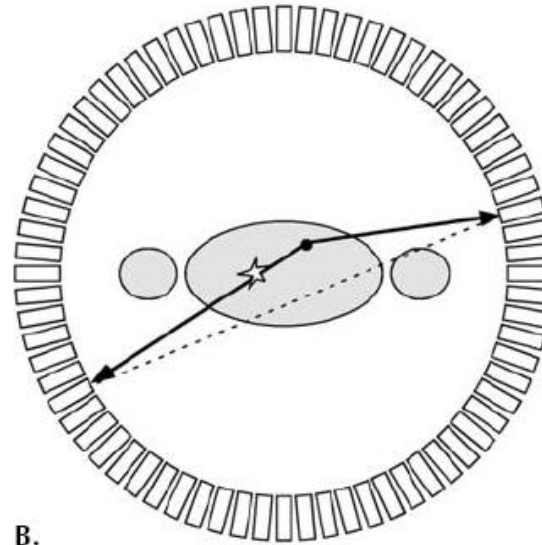

B.

Random Coincidence

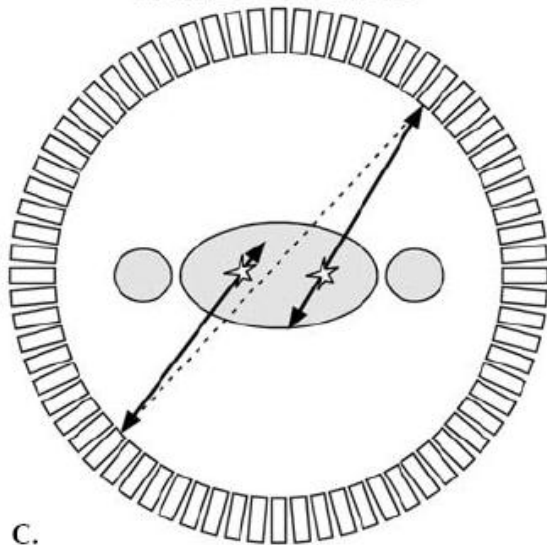

C.

Multiple Coincidence

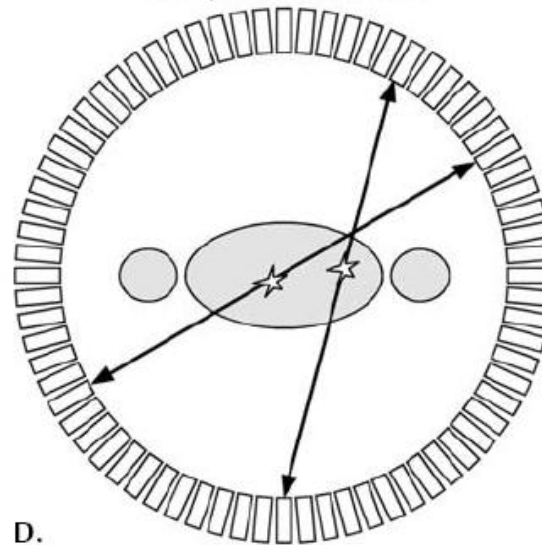

D.

Γεγονότα
χαρκτηρισμένα σαν
FALSE coincidence
σε PET scanner

$$R^{\text{acc}} = 2\tau R_1 R_2$$

2τ
Coincidence
Time-Window
 R_i
Detection Rate

Positron Emission Tomography (PET)

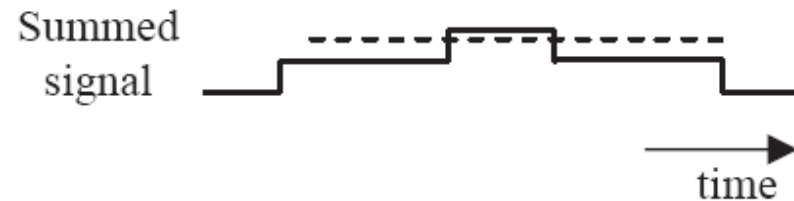
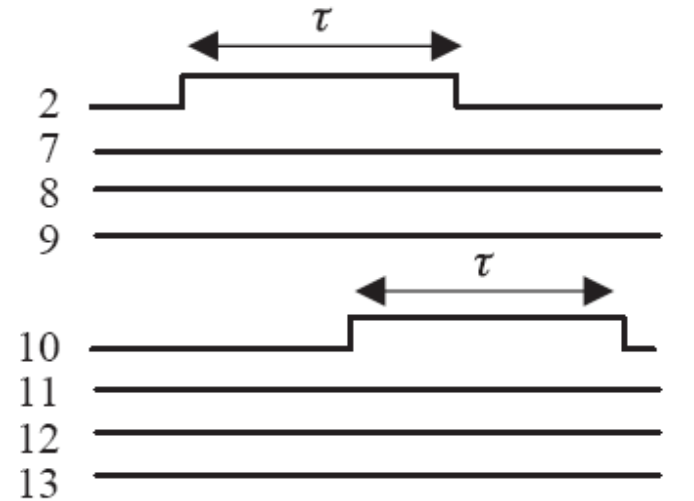
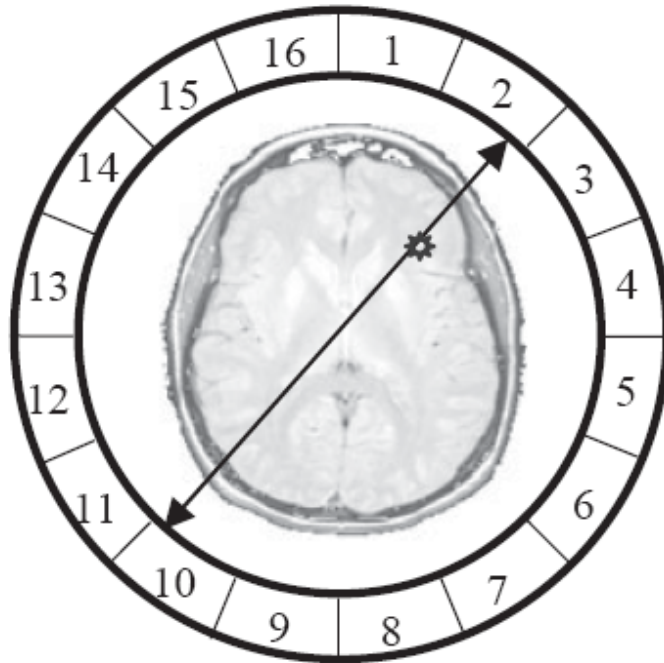

Δημιουργία ηλεκτρονικού σήματος **σύμπτωσης**.

Η **αντιδιαμετρικότητα** του γεγονότος (εξασφάλιση ότι βρίσκεται σε ευθεία / LoR) μπορεί άμεσα να ελεγχθεί με την διαφορά $|N_1 - N_2| \approx N/2$.

Στο παράδειγμα του σχήματος είναι: $N_1=2$, $N_2=10$ και $N=16$.

Positron Emission Tomography (PET)

2D direct planes

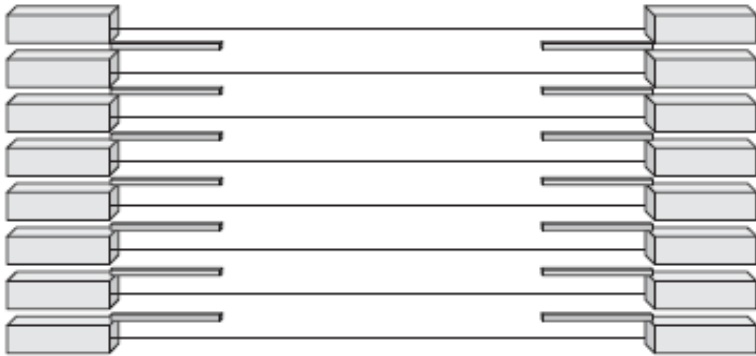

2D direct and cross planes

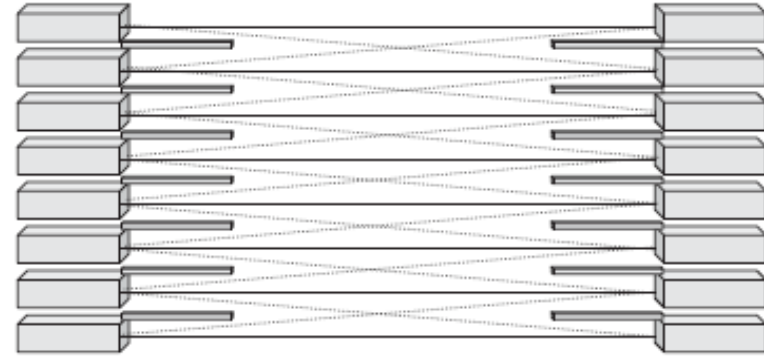

3D

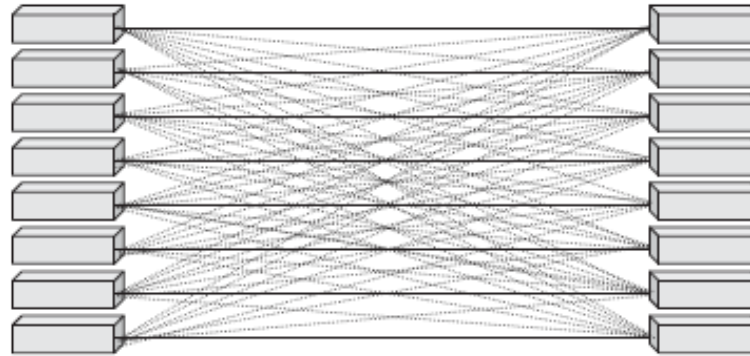

Positron Emission Tomography (PET)

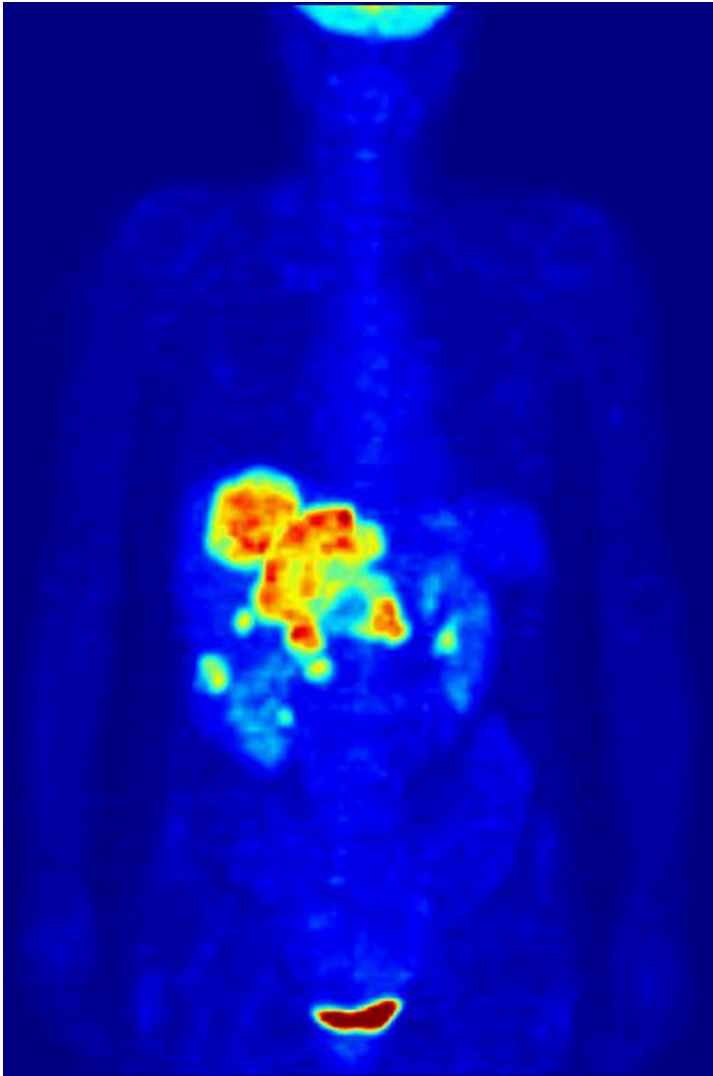

Ολόσωμη απεικόνιση PET με ^{18}F -FDG, όπου διακρίνονται ηπατικές μεταστάσεις του όγκου του παχέος εντέρου.



RatCAP

Μικροσκοπικός τομογράφος PET για εγκεφαλικές απεικονίσεις ποντικού σε εγρήγορση.

C. Woody et al., Brookhaven National Laboratory

Positron Emission Tomography (PET)

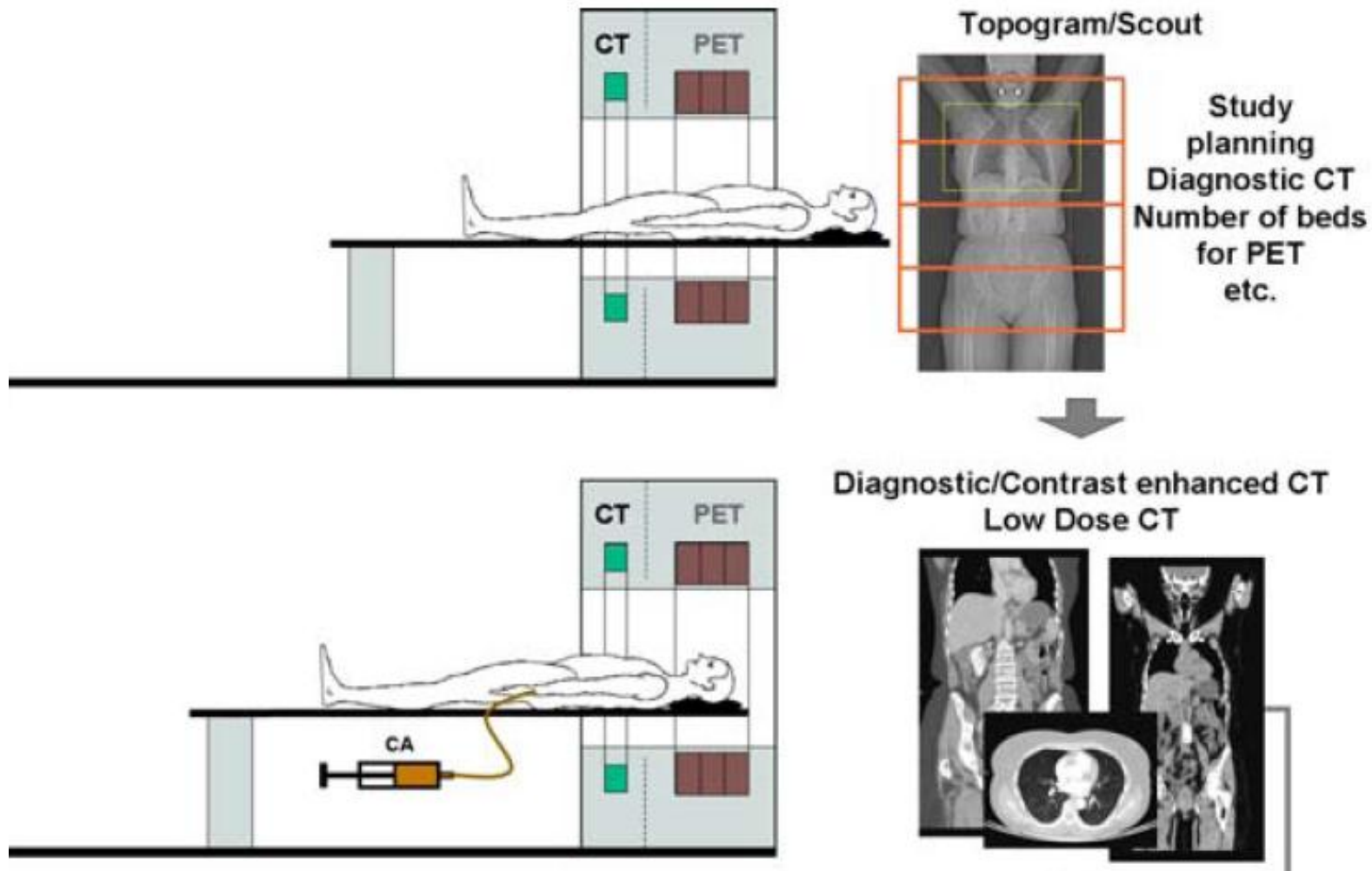

PET / CT dual-modality scanner and image fusion.

Positron Emission Tomography (PET)

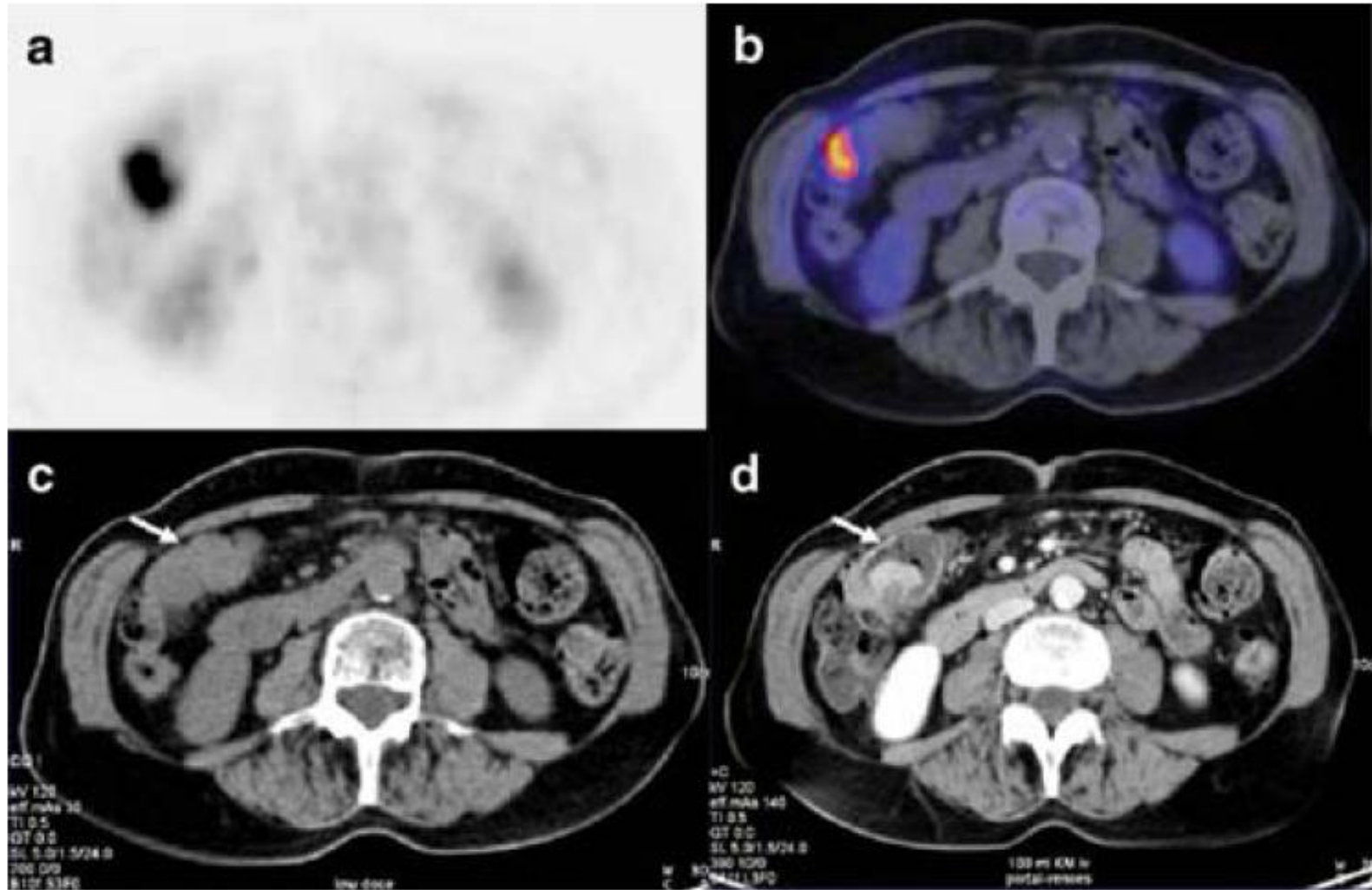

PET / CT dual-modality scanner and image fusion.

Positron Emission Tomography (PET)

^{99m}Tc -MDP

^{18}F -Fluoride-PET



Planar

SPECT

Comparison of [^{18}F]Fluoride-PET with ^{99m}Tc -MDP planar and SPECT scintigraphy in a patient with numerous bone metastases. [^{18}F] Fluoride-PET detects more lesions compared to conventional bone scan. (Grant et al. 2008).

Time of Flight PET

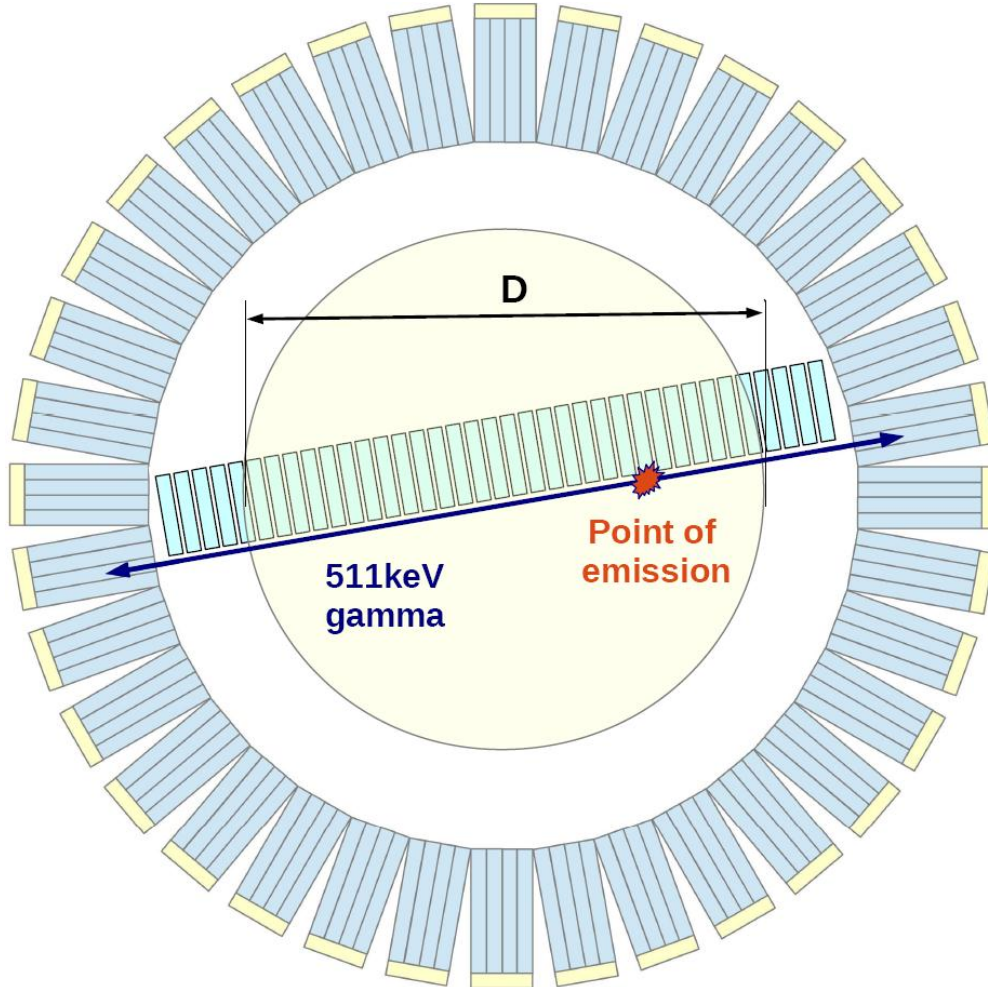

Without ToF Information

In conventional PET the position of the annihilated positron lies **anywhere** along the Line of Response (LoR).

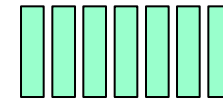

Uniform
probability along
the Line of
Response (LoR)

S. Gundacker, MEDAMI (2016)

Time of Flight PET

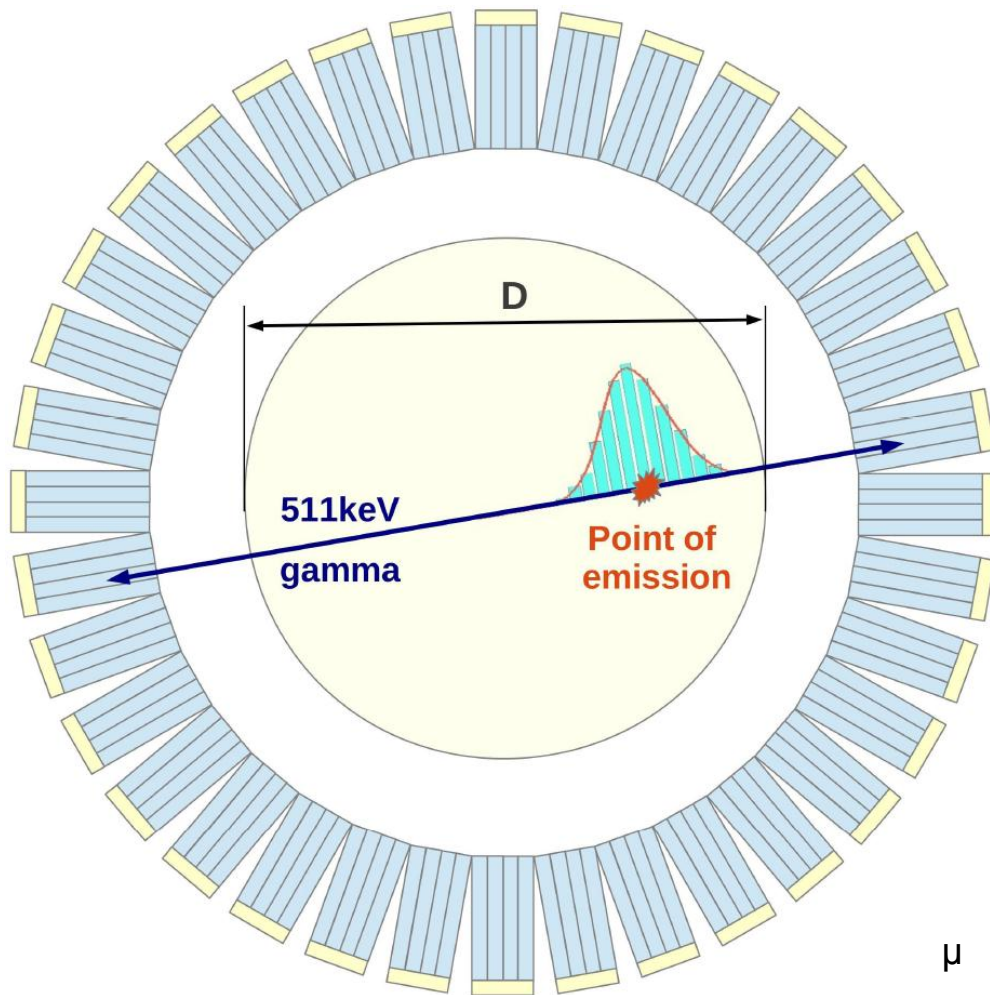

With ToF Information

The annihilation point is effectively **confined** by the time difference μ of the Time-of-Flight (ToF) signals.

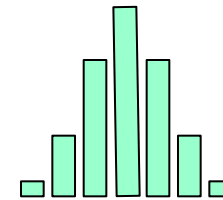

Gaussian
probability along
the Line of
Response (LoR)

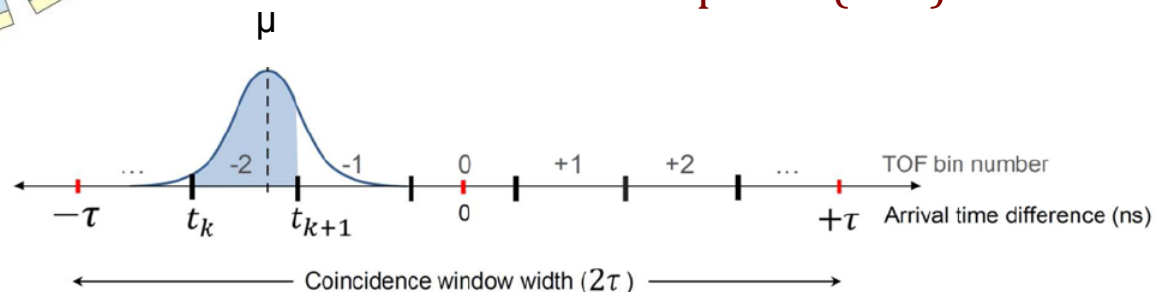

Time of Flight PET

Improvement in the image Signal-to-Noise Ratio (SNR)

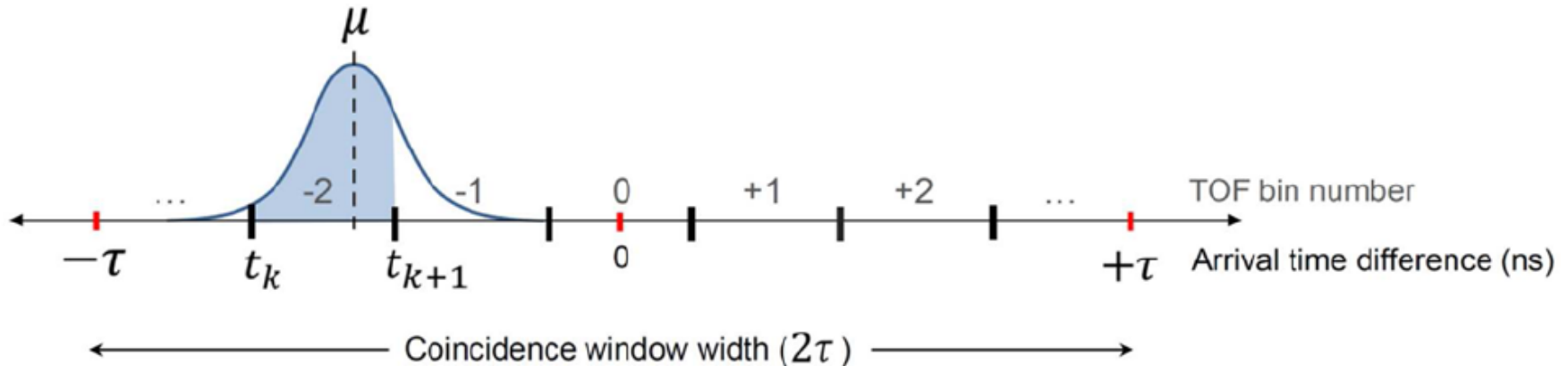

$$\frac{\text{SNR}_{\text{ToF}}}{\text{SNR}_{\text{non}}} = \sqrt{\frac{2D}{c \cdot \text{CTR}}}$$

D: Diameter of the Field of View (FoV)

c: Speed of Light in Vacuum

CTR: Coincidence Time Resolution

Improve the Coincidence Time Resolution!

Time of Flight PET

Improvement in the image Signal-to-Noise Ratio (SNR)

$$\frac{\text{SNR}_{\text{ToF}}}{\text{SNR}_{\text{non}}} = \sqrt{\frac{2D}{c \cdot \text{CTR}}}$$

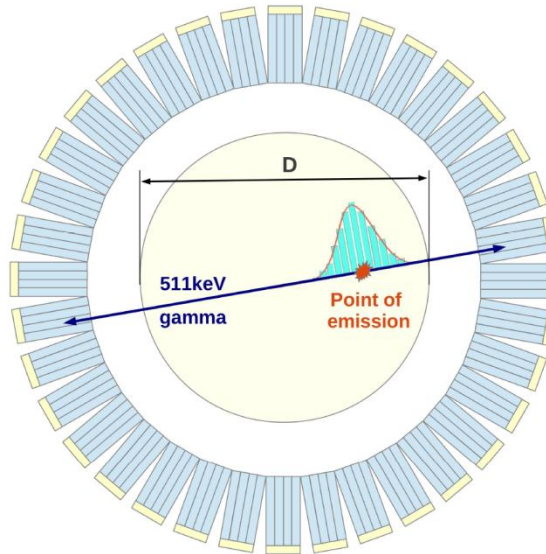

$D \approx 40\text{cm}$
for a whole body PET

CTR (ps)	Position Resolution (cm)	SNR Gain
1000	15.0	1.63
500	7.5	2.31
100	1.5	5.16

Time of Flight PET

Improvement in the image Signal-to-Noise Ratio (SNR) as a function of the Coincidence Time Resolution for different diameters of the scanner Field-of-View (FoV)

$$\frac{\text{SNR}_{\text{ToF}}}{\text{SNR}_{\text{non}}} = \sqrt{\frac{2D}{c \cdot \text{CTR}}}$$

$$\text{SNR Gain} = \frac{\text{SNR}_{\text{ToF}}}{\text{SNR}_{\text{non}}}$$

SNR Gain

- Drastically changes below 100-200 ps
- Better for larger FoVs

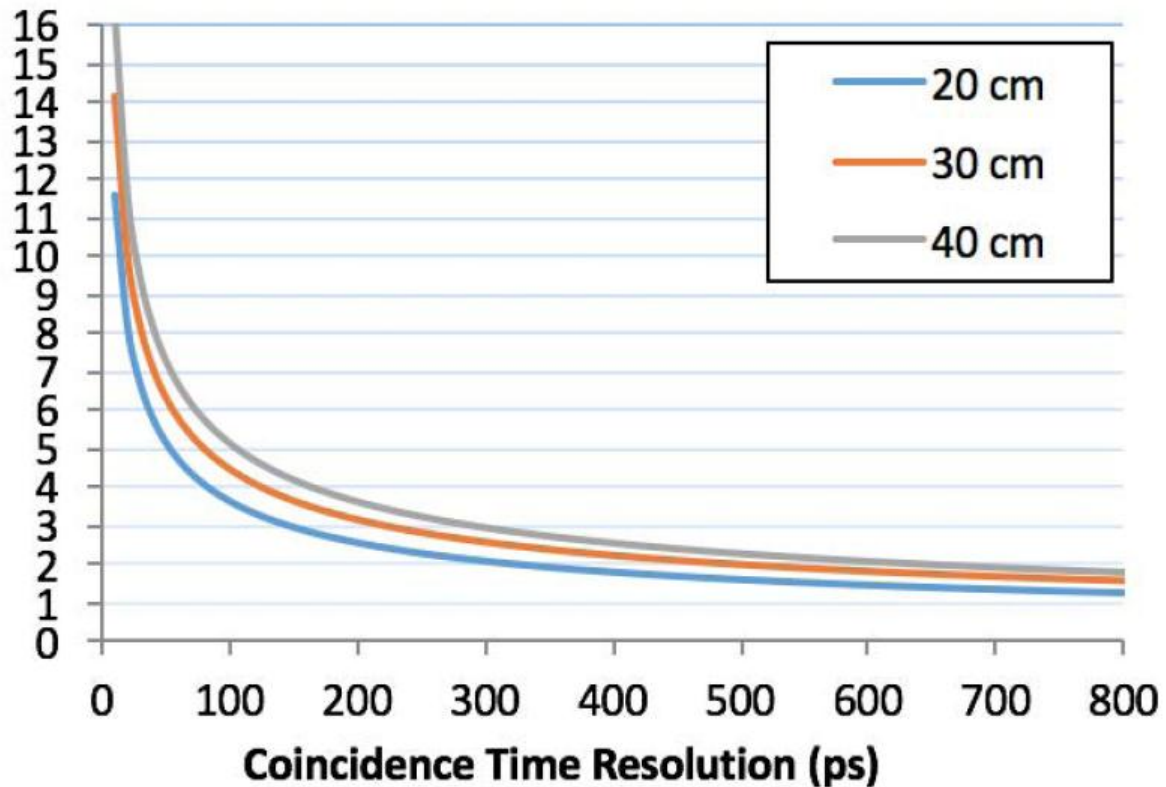

P. Lecoq, Transactions on Radiation and Plasma Medical Sciences 6 (2017) 473

Time of Flight PET

Clinical Evaluation

Gemini TF (Philips Healthcare) – LYSO ~ 600ps

Non-ToF

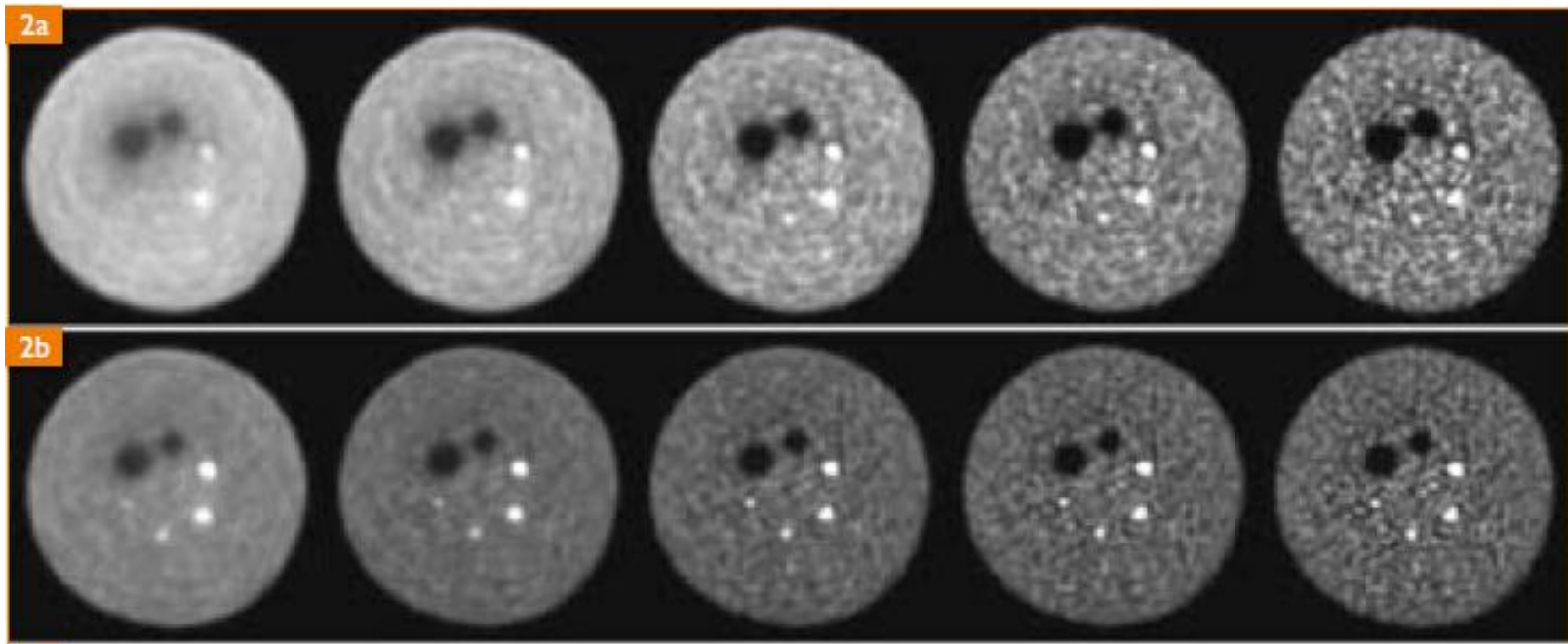

ToF

Images from measurement of a 35 cm diameter phantom (representing a heavy patient) with **two cold spheres** (28 and 37 mm) and **four hot spheres** (10, 13, 17 and 22 mm) with 6:1 contrast.

Time of Flight PET

Clinical Evaluation

Astonish TF (Philips Healthcare) – LYSO ~ 495ps

ToF

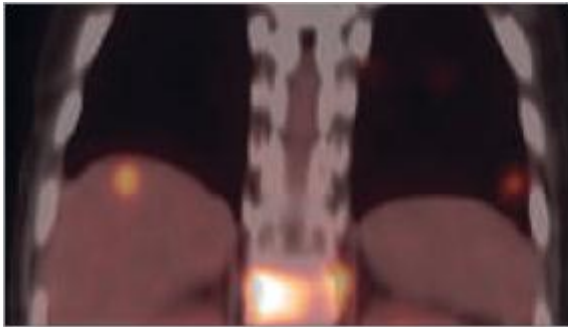

Non-ToF

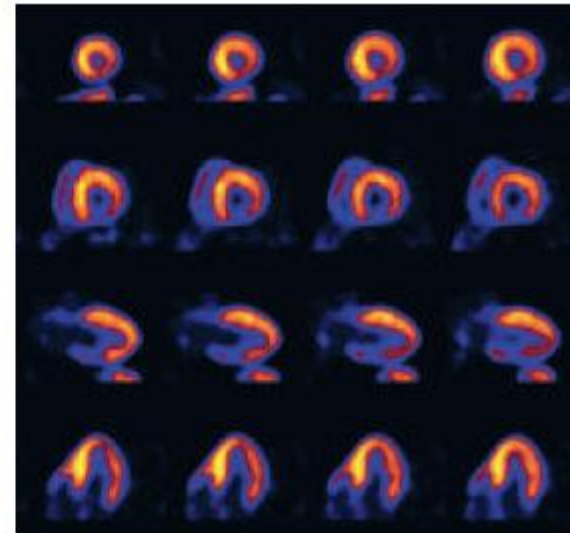
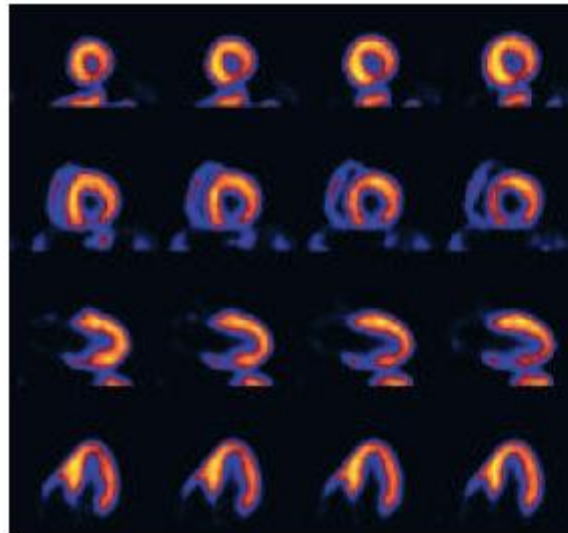

Improved signal-to-noise ratio for both **liver** and **cardiac** images with better lesion detection / more clear background.

El Fakhri *et al.*, J. Nucl. Med. 52 (2011) 347-353

Time of Flight PET

Clinical Evaluation

SIGNA ToF-PET / MR (GE Healthcare) – LSO ~ 400ps

OSEM

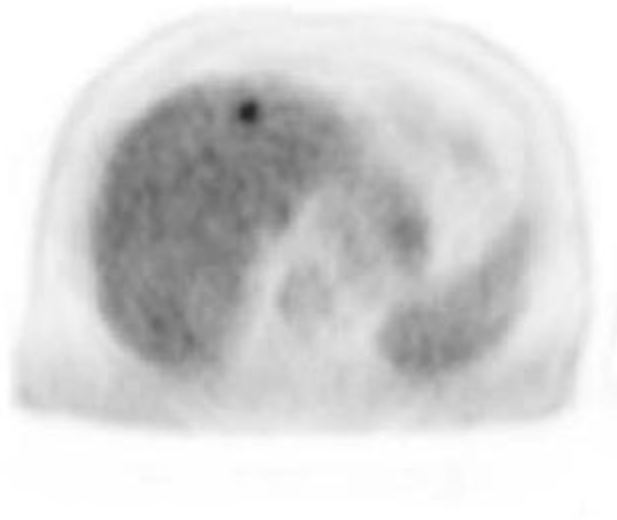

OSEM+TOF

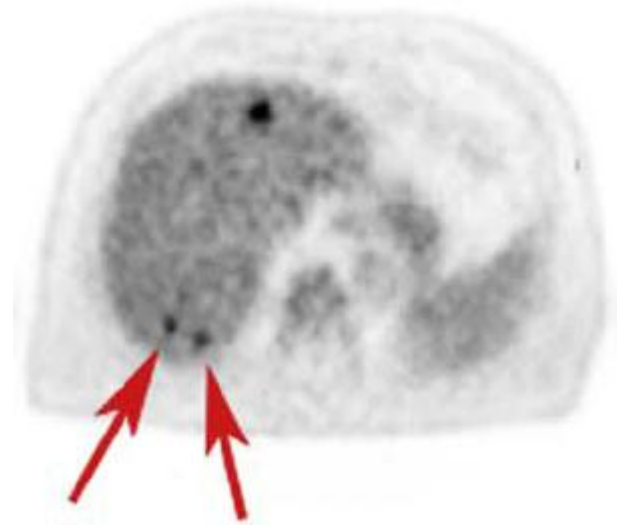

OSEM: Ordered Subset Expectation Maximization

Male patient with **liver metastases** from pancreatic cancer.

Positron Emission Tomography (PET)

Time of Flight (ToF) PET Scanners

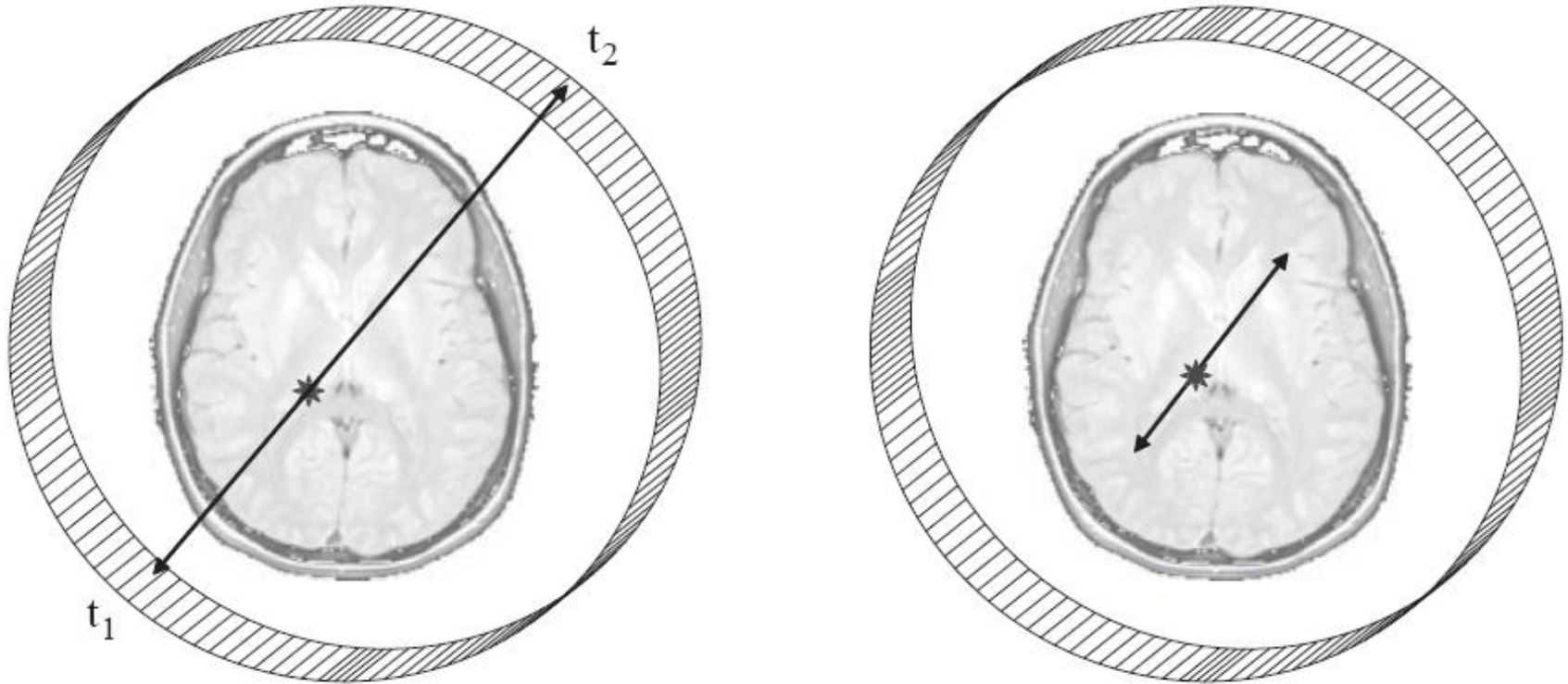

A timing resolution of 500 ps corresponds to a spatial resolution of ~ 7.5 cm. Therefore, it would appear that ToF PET offers no advantages over conventional PET since the latter already has a spatial resolution of the order of several millimetres. However, being able to constrain the length of the LOR from its value in conventional PET to 7.5 cm reduces the statistical noise inherent in the measurement.

ΠΑΡΑΓΩΓΗ ΡΑΔΙΟΦΑΡΜΑΚΩΝ

Ραδιοφάρμακα στην Μονοφωτονική Τομοσπινθηρογραφία (SPECT)

Radiotracer	Half-life (hours)	γ -ray energy (keV)	Clinical application
^{99m}Tc	6.0	140	various
^{67}Ga	76.8	93, 185, 300, 394	tumour detection
^{201}Tl	72	167, 68–82 (X-rays)	myocardial viability
^{133}Xe	127.2	81	lung ventilation
^{111}In	67.2	171, 245	inflammation

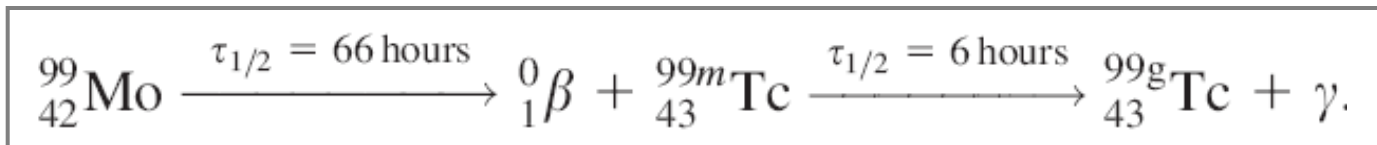

ΠΑΡΑΓΩΓΗ ΡΑΔΙΟΦΑΡΜΑΚΩΝ

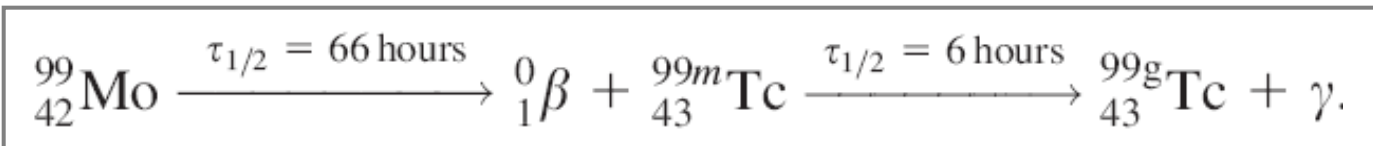
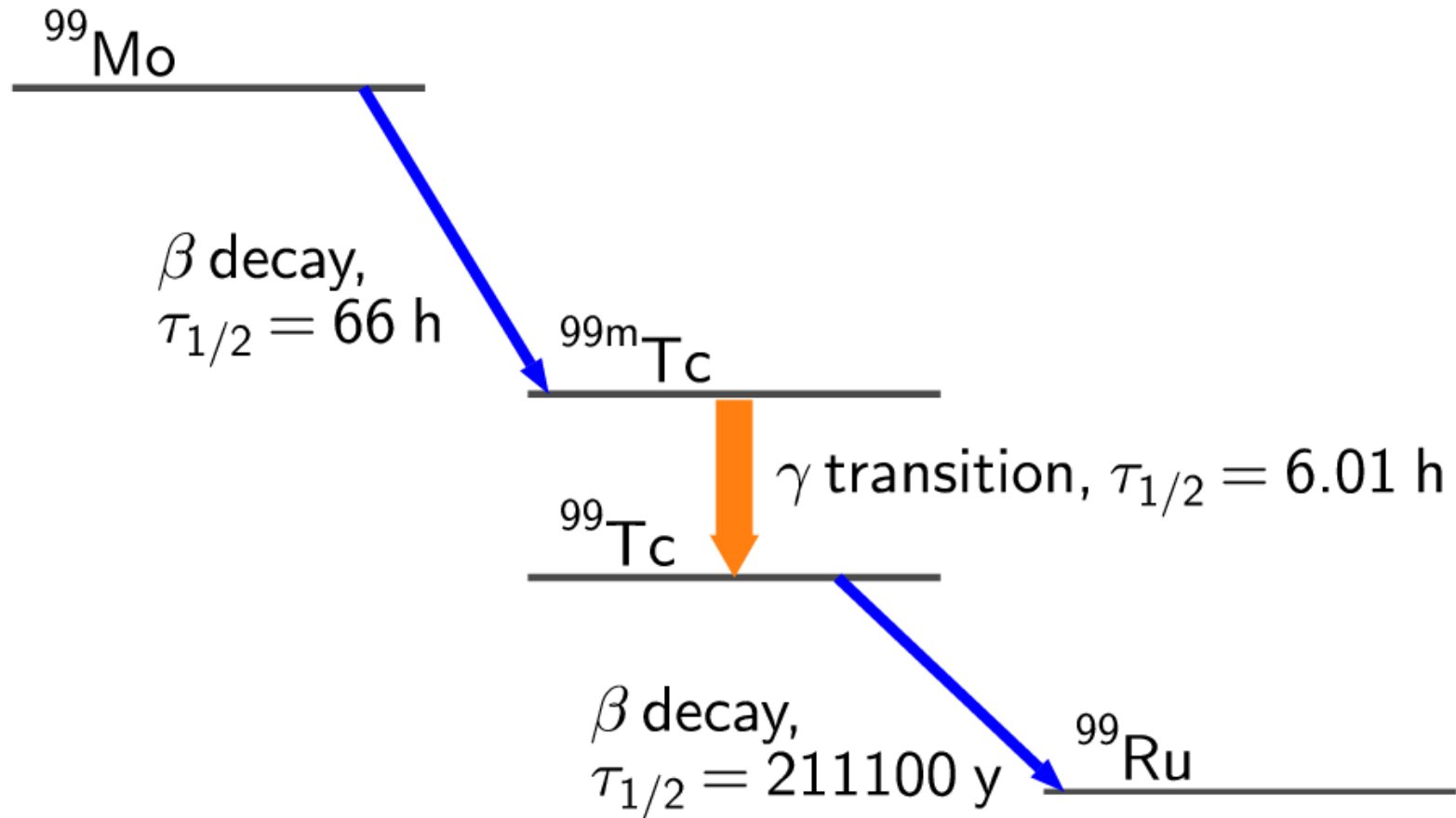

ΠΑΡΑΓΩΓΗ ΡΑΔΙΟΦΑΡΜΑΚΩΝ

Η γεννήτρια Τεχνητίου ^{99m}Tc

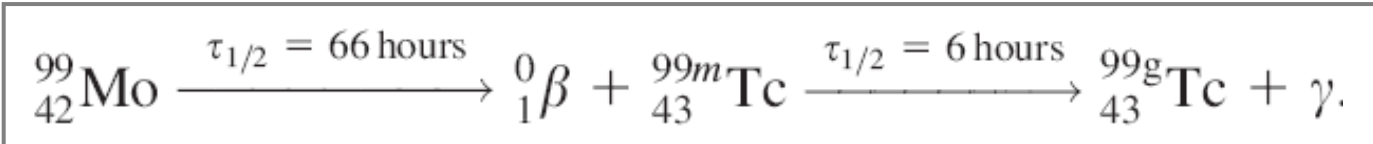
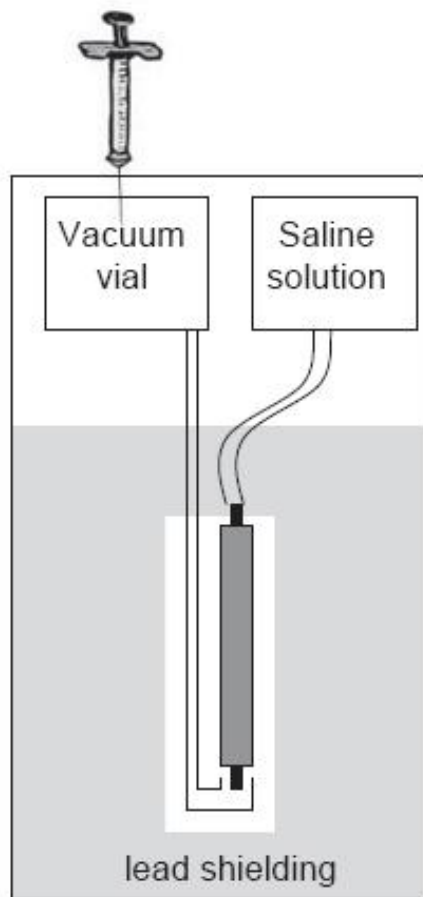

ΠΑΡΑΓΩΓΗ ΡΑΔΙΟΦΑΡΜΑΚΩΝ

Η γεννήτρια Τεχνητίου ^{99m}Tc

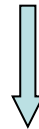
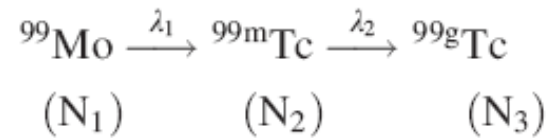

$$\frac{dN_2}{dt} = \lambda_1 N_1 - \lambda_2 N_2 \Rightarrow \frac{dN_2}{dt} + \lambda_2 N_2 = \lambda_1 N_1.$$

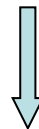

$$Q_2 = \lambda_2 N_2 = \frac{\lambda_1 \lambda_2 N_0}{\lambda_2 - \lambda_1} (e^{-\lambda_1 t} - e^{-\lambda_2 t})$$

ΠΑΡΑΓΩΓΗ ΡΑΔΙΟΦΑΡΜΑΚΩΝ

Η γεννήτρια Τεχνητίου ^{99m}Tc

Radioactivity of ^{99}Mo

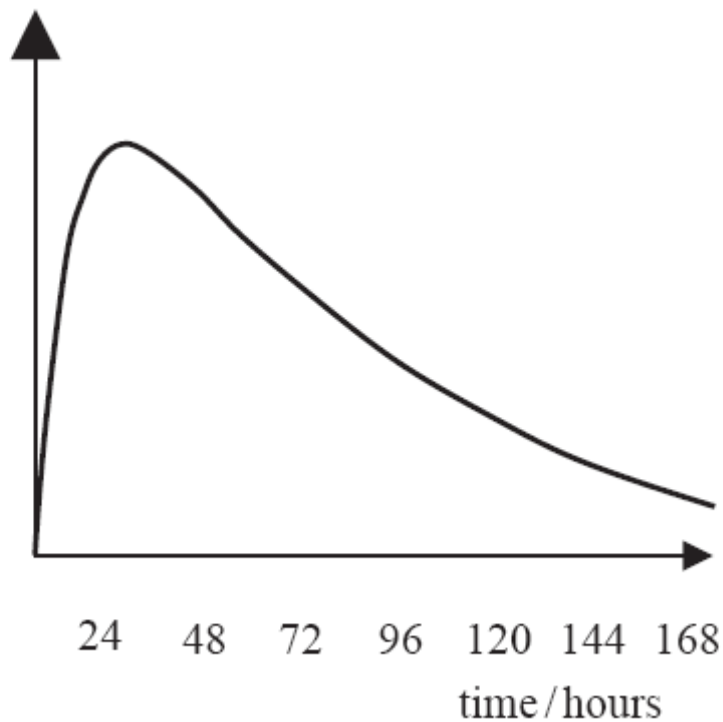

Radioactivity of ^{99m}Tc

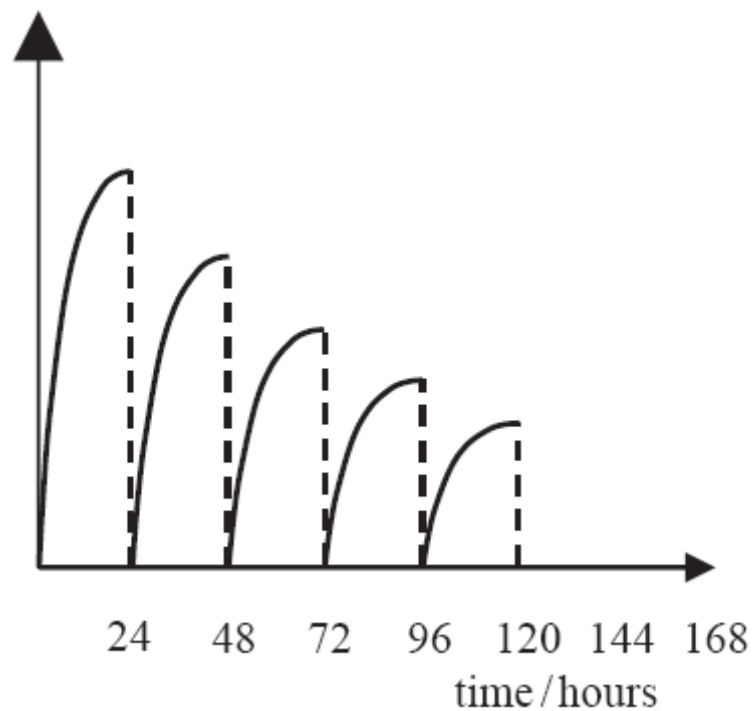

ΠΑΡΑΓΩΓΗ ΡΑΔΙΟΦΑΡΜΑΚΩΝ

Ραδιοϊσότοπα για SPECT

Isotope	E(γ) [keV]	Half-Life [h]
^{99m}Tc	140	6.0
^{123}I	127	13.1
^{201}Tl	167	73.1
^{67}Ga	153 (93, 185, 288, 394)	78

Ραδιοϊσότοπα για PET

Isotope	E(β^+) _{max} [keV]	Half-Life [min]
^{18}F	635	109.7
^{11}C	970	20.4
^{13}N	1190	9.96
^{15}O	1720	2.07
^{82}Rb	3180	1.27

Πυρηνικές Αντιδράσεις Παραγωγής

Radionuclide	Half-life	Reaction
Tc-99m	6.0 h	$^{100}\text{Mo}(p, 2n)$
I-123	13.1 h	$^{124}\text{Xe}(p, 2n)^{123}\text{Cs}$ $^{124}\text{Xe}(p, pn)^{123}\text{Xe}$ $^{124}\text{Xe}(p, 2pn)^{123}\text{I}$ $^{123}\text{Te}(p, n)^{123}\text{I}$ $^{124}\text{Te}(p, 2n)^{123}\text{I}$
Tl-201	73.1 h	$^{203}\text{Tl}(p, 3n)^{201}\text{Pb} \rightarrow ^{201}\text{Tl}$

C-11	20.3 min	$^{14}\text{N}(p, \alpha)$ $^{11}\text{B}(p, n)$
F-18	110 min	$^{18}\text{O}(p, n)$ $^{20}\text{Ne}(d, \alpha)$ $^{\text{nat}}\text{Ne}(p, X)$

ΕΦΑΡΜΟΓΗ ΠΟΛΛΑΠΛΩΝ ΤΕΧΝΙΚΩΝ

SPECT / CT

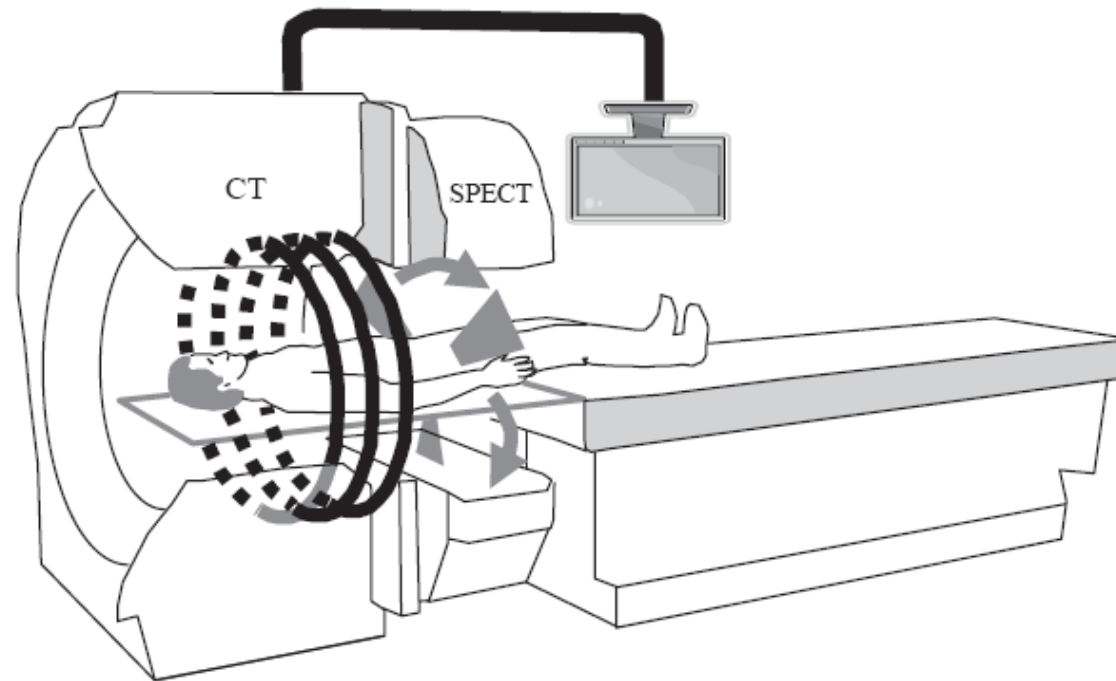

^{99m}Tc -sestamibi



ΕΦΑΡΜΟΓΗ ΠΟΛΛΑΠΛΩΝ ΤΕΧΝΙΚΩΝ

PET / CT

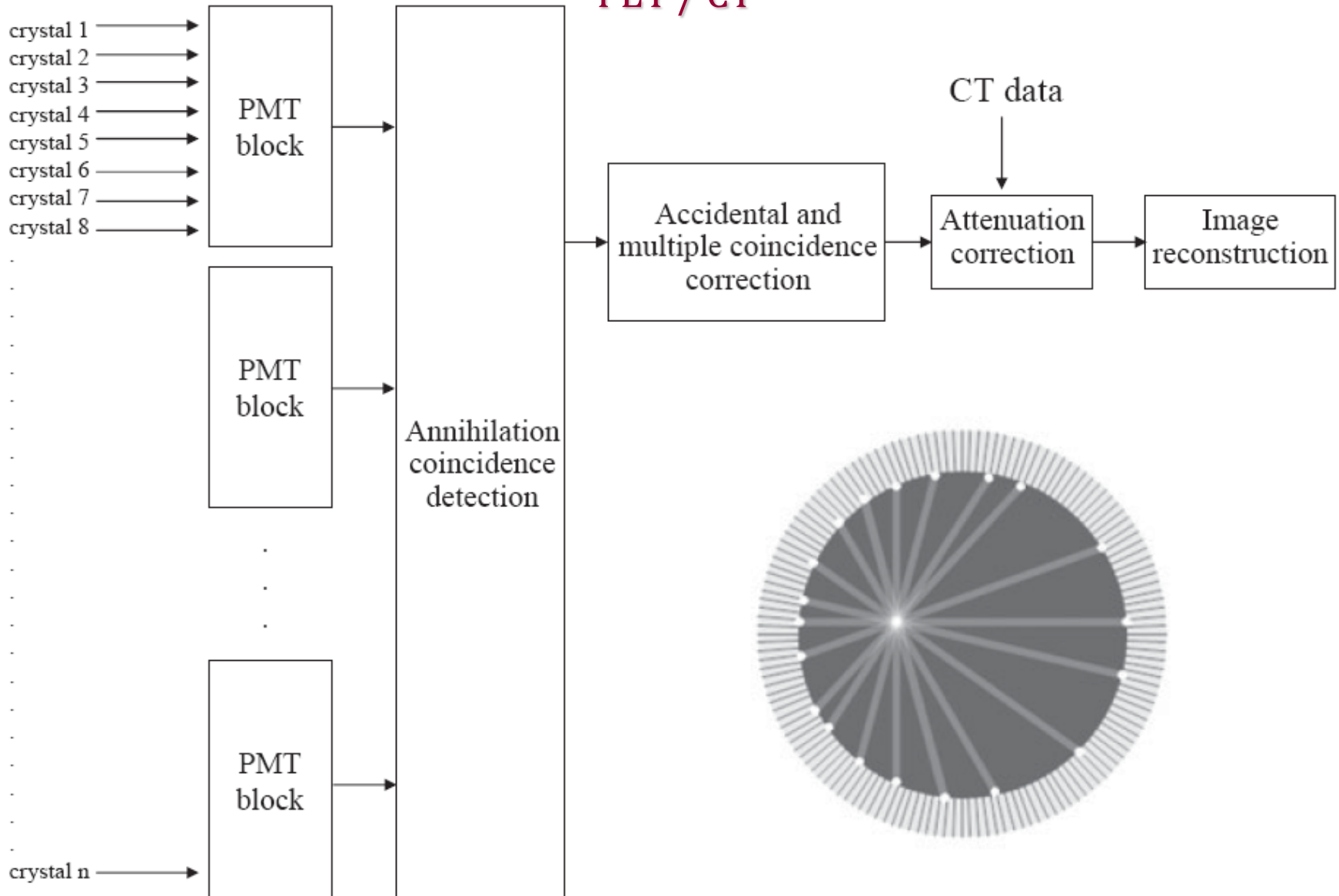

ΕΦΑΡΜΟΓΗ ΠΟΛΛΑΠΛΩΝ ΤΕΧΝΙΚΩΝ

Αρχή Λειτουργίας της Compton Camera

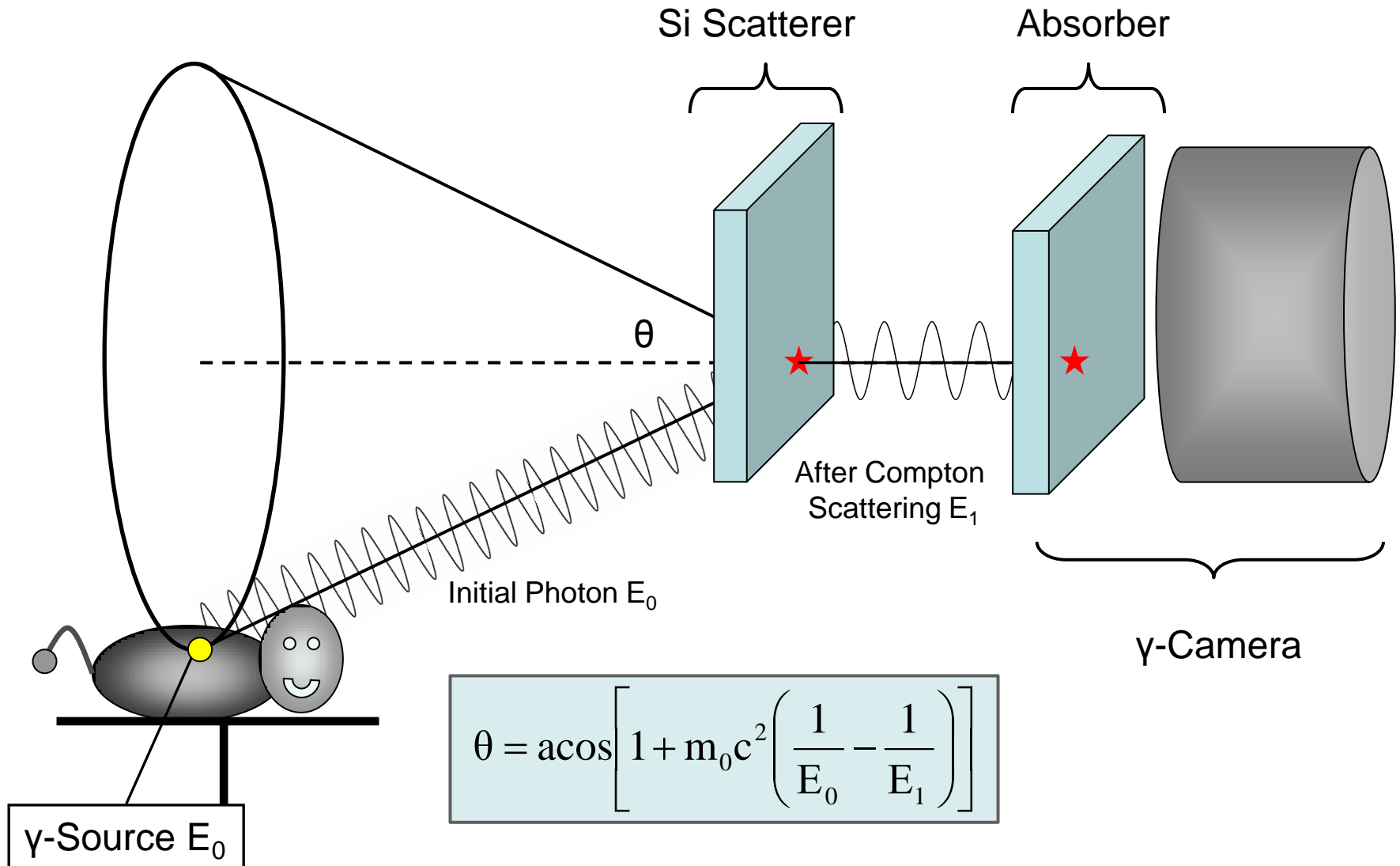

Compton Camera - Image Reconstruction

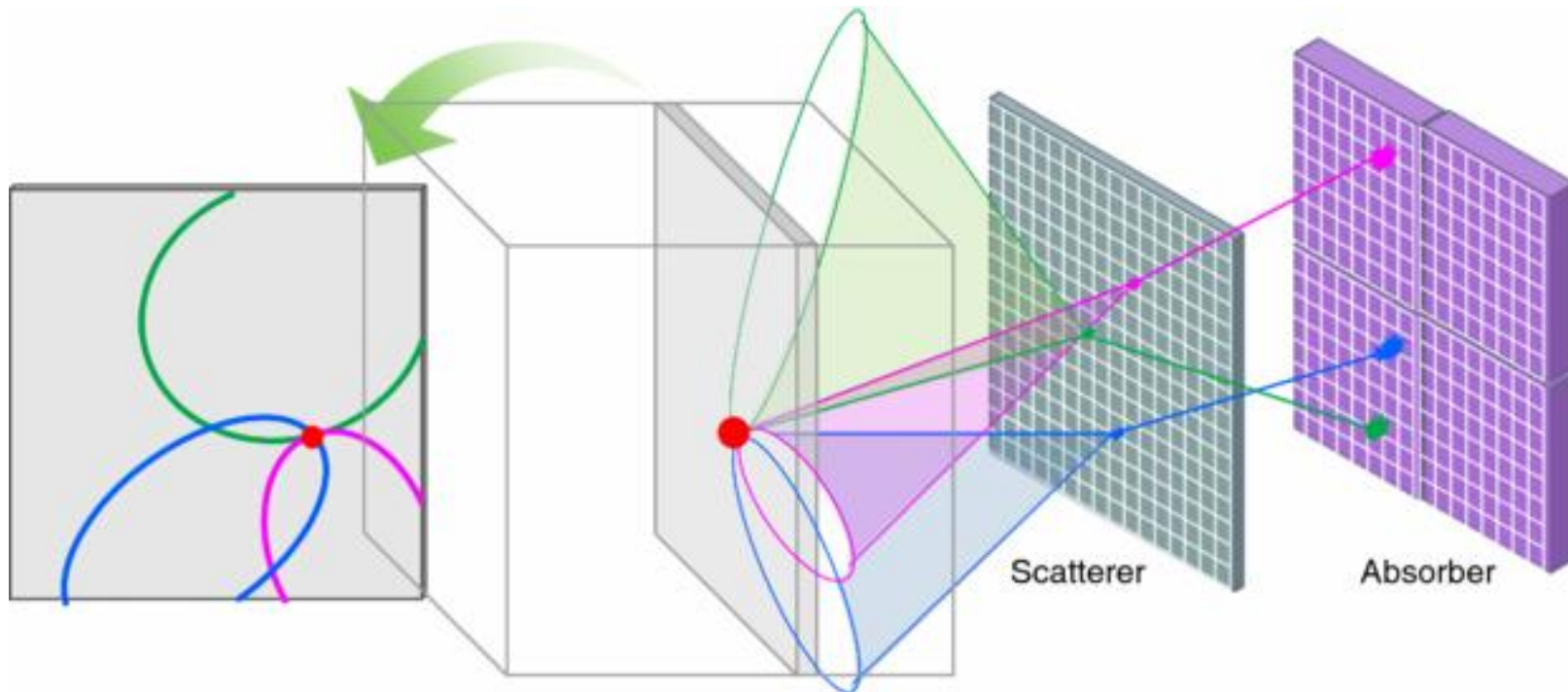

Προβολική Εικόνα

Προκύπτει από τις τομές των κωνικών επιφανειών (γεωμετρικός τύπος) με το προβολικό επίπεδο, παράλληλα προς τον σκεδαστή-απορροφητή.

$$\theta = \text{acos} \left[1 + m_0 c^2 \left(\frac{1}{E_0} - \frac{1}{E_1} \right) \right]$$

Compton Camera - Image Reconstruction

Ομοίωμα με τρεις ομοεπίπεδες σημειακές πηγές

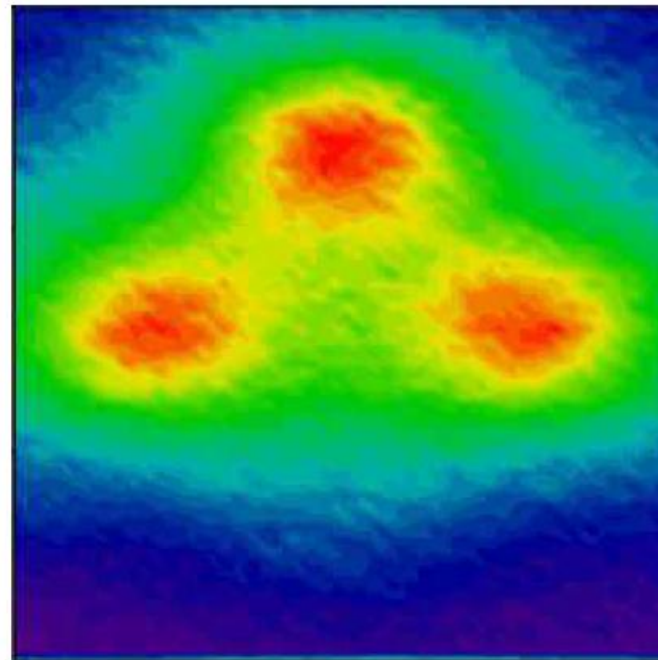
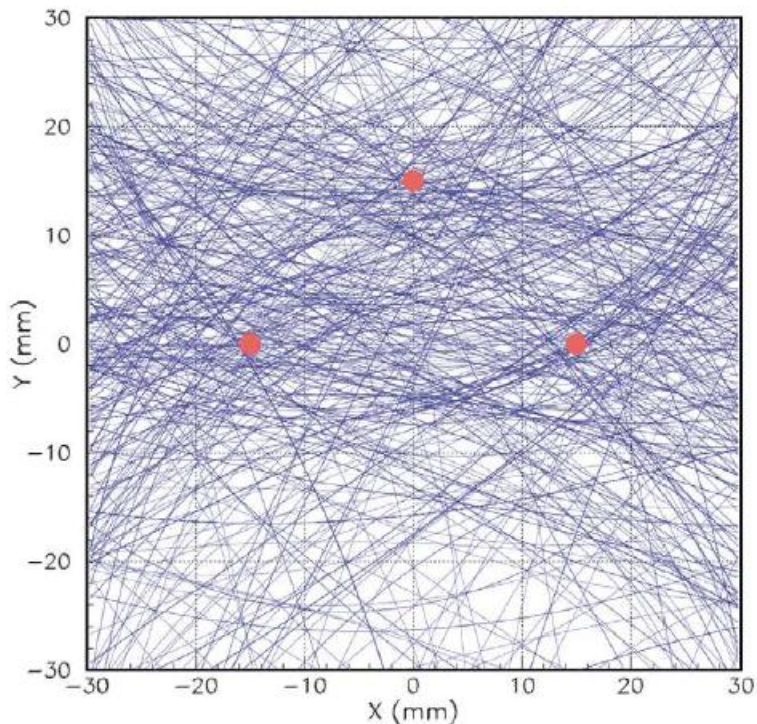

Με βάση τη γεωμετρική αυτή ανακατασκευή, η θέση, η ένταση και τα γεωμετρικά χαρακτηριστικά των πηγών εξαγονται από την κατανομή της πυκνότητας των τομών ανά pixel.