Feedback Control Systems

10.1 Introduction

This chapter focuses on one and two degrees of freedom feedback control systems that have been studied, using Polynomial Matrix (PMD) and Matrix Fractional (MFD) Descriptions. The chapter starts by considering in Section 10.2 interconnected systems and their properties, with emphasis on systems connected via feedback interconnections. Internal stability is central in the development, and all stabilizing feedback controllers are parameterized in Section 10.3. The role of the Diophantine equation is also explained. In Section 10.4 two degrees of freedom controllers are studied at length.

10.2 Interconnected Systems

Interconnected systems, connected in parallel, series, and feedback configurations are studied in the present section. It is shown that particular interconnections may introduce uncontrollable, unobservable, or unstable modes into a system; for a more detailed development, see [1, p. 568, Subsection 7.3C]. Feedback configurations, as well as series interconnections, are of particular importance in the control of systems.

10.2.1 Systems Connected in Parallel and in Series

In Parallel

Consider first systems S_1 and S_2 connected in parallel as shown in Figure 10.1, and let

$$P_1(q)z_1(t) = Q_1(q)u_1(t), \quad y_1(t) = R_1(q)z_1(t) \quad (10.1)$$

and

$$P_2(q)z_2(t) = Q_2(q)u_2(t), \quad y_2(t) = R_2(q)z_2(t) \quad (10.2)$$

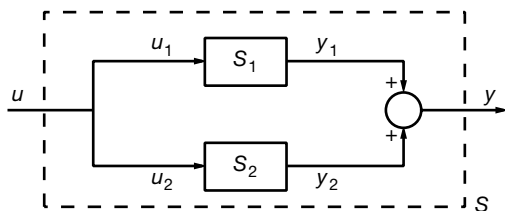

Figure 10.1. Systems connected in parallel

be representations (PMDs) for S_1 and S_2 , respectively; see Section 7.5. Since $u(t) = u_1(t) = u_2(t)$ and $y(t) = y_1(t) + y_2(t)$, the overall system description is given by

$$\begin{bmatrix} P_1(q) & 0 \\ 0 & P_2(q) \end{bmatrix} \begin{bmatrix} z_1(q) \\ z_2(q) \end{bmatrix} = \begin{bmatrix} Q_1(q) \\ Q_2(q) \end{bmatrix} u(t), y(t) = [R_1(q), R_2(q)] \begin{bmatrix} z_1(t) \\ z_2(t) \end{bmatrix}. \tag{10.3}$$

If the systems S_1 and S_2 are described by the state-space representations $\dot{x}_i = A_i x_i + B_i u_i$, $y_i = C_i x_i + D_i u_i$, $i = 1, 2$, then the overall system state-space description is given by

$$\begin{bmatrix} \dot{x}_1 \\ \dot{x}_2 \end{bmatrix} = \begin{bmatrix} A_1 & 0 \\ 0 & A_2 \end{bmatrix} \begin{bmatrix} x_1 \\ x_2 \end{bmatrix} + \begin{bmatrix} B_1 \\ B_2 \end{bmatrix} u, \\ y = [C_1, C_2] \begin{bmatrix} x_1 \\ x_2 \end{bmatrix} + [D_1 + D_2]u. \tag{10.4}$$

If $H_1(s), H_2(s)$ are the transfer function matrices of S_1 and S_2 , respectively, then the overall transfer function can be found from $\hat{y}(s) = \hat{y}_1(s) + \hat{y}_2(s) = H_1(s)\hat{u}_1(s) + H_2(s)\hat{u}_2(s) = [H_1(s) + H_2(s)]\hat{u}(s)$ to be

$$H(s) = H_1(s) + H_2(s). \tag{10.5}$$

Note that if both $H_1(s)$ and $H_2(s)$ are proper, then $H(s)$ is also proper.

In Series

Consider now systems S_1 and S_2 connected in series, as shown in Figure 10.2, and let (10.1) and (10.2) describe the systems. Here $u_2(t) = y_1(t)$. To derive

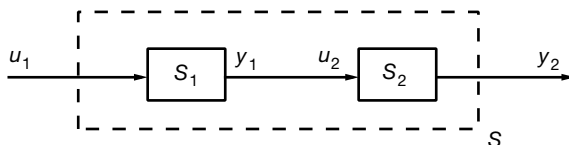

Figure 10.2. Systems connected in series

the overall system description, consider $P_2 z_2 = Q_2 u_2 = Q_2 y_1 = Q_2 R_1 z_1$. Then

$$\begin{bmatrix} P_1 & 0 \\ -Q_2 R_1 & P_2 \end{bmatrix} \begin{bmatrix} z_1 \\ z_2 \end{bmatrix} = \begin{bmatrix} Q_1 \\ 0 \end{bmatrix} u_1, \quad (10.6)$$

$$y_2 = [0, R_2] \begin{bmatrix} z_1 \\ z_2 \end{bmatrix}.$$

If the systems S_1, S_2 are described by the state-space representations $\dot{x}_i = A_i x_i + C_i u_i$, $y_i = C_i x_i + D_i u_i$, $i = 1, 2$, then it can be shown that the overall system state-space description is given by

$$\begin{bmatrix} \dot{x}_1 \\ \dot{x}_2 \end{bmatrix} = \begin{bmatrix} A_1 & 0 \\ B_2 C_1 & A_2 \end{bmatrix} \begin{bmatrix} x_1 \\ x_2 \end{bmatrix} + \begin{bmatrix} B_1 & 0 \\ B_2 D_1 & B_2 \end{bmatrix} \begin{bmatrix} u_1 \\ r_2 \end{bmatrix}, \quad (10.7)$$

$$\begin{bmatrix} y_1 \\ y_2 \end{bmatrix} = \begin{bmatrix} C_1 & 0 \\ D_2 C_1 & C_2 \end{bmatrix} \begin{bmatrix} x_1 \\ x_2 \end{bmatrix} + \begin{bmatrix} D_1 & 0 \\ D_2 D_1 & D_2 \end{bmatrix} \begin{bmatrix} u_1 \\ r_2 \end{bmatrix}.$$

If $H_1(s), H_2(s)$ are the transfer function matrices of S_1 and S_2 , then the overall transfer function $\hat{y}_2(s) = H(s)\hat{u}_1(s)$ is

$$H(s) = H_2(s)H_1(s). \quad (10.8)$$

It can be shown that if both H_1 and H_2 are proper, then H is also proper. Note that poles of H_1 and H_2 may cancel in the product $H_2 H_1$ and any cancellation implies that there are uncontrollable/unobservable eigenvalues in the overall system internal description.

10.2.2 Systems Connected in Feedback Configuration

Consider systems S_1 and S_2 connected in a feedback configuration as shown in Figure 10.3a, or equivalently as in Figure 10.3b. Let

$$P_1(q)z_1(t) = Q_1(q)u_1(t), \quad y_1(t) = R_1(q)z_1(t) \quad (10.9)$$

and

$$P_2(q)z_2(t) = Q_2(q)u_2(t), \quad y_2(t) = R_2(q)z_2(t) \quad (10.10)$$

be polynomial matrix representations of S_1 and S_2 , respectively. Since

$$u_1(t) = y_2(t) + r_1(t), \quad (10.11)$$

$$u_2(t) = y_1(t) + r_2(t), \quad (10.12)$$

where r_1 and r_2 are external inputs, the dimensions of the vector inputs and outputs, u_1 and y_2 and also u_2 and y_1 must be the same. To derive the overall system description we consider $P_1 z_1 = Q_1 u_1 = Q_1(y_2 + r_1)$ and $P_2 z_2 = Q_2 u_2 = Q_2(y_1 + r_2)$ where y_1 and y_2 are as above. Then the closed-loop is described by

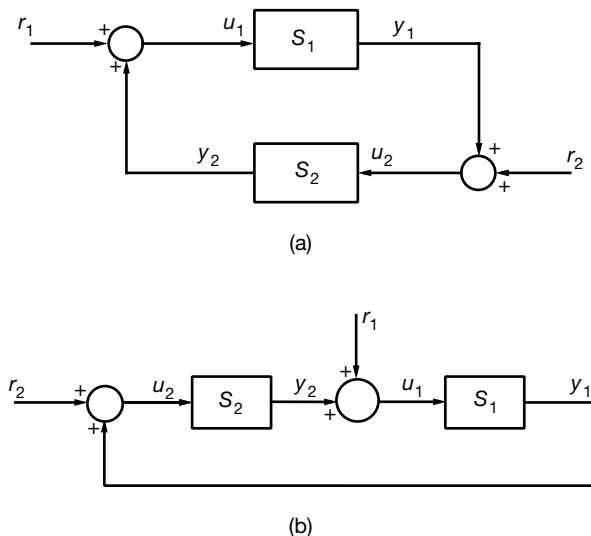

Figure 10.3. Feedback configuration

$$\begin{bmatrix} P_1 & -Q_1R_2 \\ -Q_2R_1 & P_2 \end{bmatrix} \begin{bmatrix} z_1 \\ z_2 \end{bmatrix} = \begin{bmatrix} Q_1 & 0 \\ 0 & Q_2 \end{bmatrix} \begin{bmatrix} r_1 \\ r_2 \end{bmatrix}, \begin{bmatrix} y_1 \\ y_2 \end{bmatrix} = \begin{bmatrix} R_1 & 0 \\ 0 & R_2 \end{bmatrix} \begin{bmatrix} z_1 \\ z_2 \end{bmatrix}. \tag{10.13}$$

Note that the condition for the closed-loop system to be well defined is that

$$\det \left(\begin{bmatrix} P_1 & -Q_1R_2 \\ -Q_2R_1 & P_2 \end{bmatrix} \right) \neq 0. \tag{10.14}$$

If this condition is not satisfied, then the closed-loop system cannot be described by the polynomial matrix representations discussed here.

If the systems S_1 and S_2 are described by the state-space representations $\dot{x}_i = A_i x_i + B_i u_i$, $y_i = C_i x_i + D_i u_i$, $i = 1, 2$, then it can be shown that the closed-loop system state-space description is

$$\begin{bmatrix} \dot{x}_1 \\ \dot{x}_2 \end{bmatrix} = \begin{bmatrix} A_1 + B_1 M_2 D_2 C_1 & B_1 M_2 C_2 \\ B_2 M_1 C_1 & A_2 + B_2 M_1 D_1 C_2 \end{bmatrix} \begin{bmatrix} x_1 \\ x_2 \end{bmatrix} + \begin{bmatrix} B_1 M_2 & B_1 M_2 D_2 \\ B_2 M_1 D_1 & B_2 M_1 \end{bmatrix} \begin{bmatrix} r_1 \\ r_2 \end{bmatrix}, \\ \begin{bmatrix} y_1 \\ y_2 \end{bmatrix} = \begin{bmatrix} M_1 C_1 & M_1 D_1 C_2 \\ M_2 D_2 C_1 & M_2 C_2 \end{bmatrix} \begin{bmatrix} x_1 \\ x_2 \end{bmatrix} + \begin{bmatrix} M_1 D_1 & M_1 D_1 D_2 \\ M_2 D_2 D_1 & M_2 D_2 \end{bmatrix} \begin{bmatrix} r_1 \\ r_2 \end{bmatrix}, \tag{10.15}$$

where $M_1 = (I - D_1 D_2)^{-1}$ and $M_2 = (I - D_2 D_1)^{-1}$. It is assumed that $\det(I - D_1 D_2) = \det(I - D_2 D_1) \neq 0$.

It is not difficult to see that in the case of state-space representations the conditions for the closed-loop system state-space representation to be well defined is $\det(I - D_1 D_2) \neq 0$. When $D_1 = 0$ and $D_2 = 0$, then (10.15) simplifies to

$$\begin{aligned} \begin{bmatrix} \dot{x}_1 \\ \dot{x}_2 \end{bmatrix} &= \begin{bmatrix} A_1 & B_1 C_2 \\ B_2 C_1 & A_2 \end{bmatrix} \begin{bmatrix} x_1 \\ x_2 \end{bmatrix} + \begin{bmatrix} B_1 & 0 \\ 0 & B_2 \end{bmatrix} \begin{bmatrix} r_1 \\ r_2 \end{bmatrix}, \\ \begin{bmatrix} y_1 \\ y_2 \end{bmatrix} &= \begin{bmatrix} C_1 & 0 \\ 0 & C_2 \end{bmatrix} \begin{bmatrix} x_1 \\ x_2 \end{bmatrix}. \end{aligned} \tag{10.16}$$

Example 10.1. Consider systems S_1 and S_2 in a feedback configuration with $H_1(s) = \frac{s}{s+1}$ and $H_2(s) = 1$ and consider the realizations $\{P_1, Q_1, R_1, W_1\} = \{q+1, q, 1, 0\}$ and $\{P_2, Q_2, R_2, W_2\} = \{1, 1, 1, 0\}$. Then (10.13) becomes

$$\begin{aligned} \begin{bmatrix} q+1 & -q \\ -1 & 1 \end{bmatrix} \begin{bmatrix} z_1 \\ z_2 \end{bmatrix} &= \begin{bmatrix} q & 0 \\ 0 & 1 \end{bmatrix} \begin{bmatrix} r_1 \\ r_2 \end{bmatrix}, \\ \begin{bmatrix} y_1 \\ y_2 \end{bmatrix} &= \begin{bmatrix} 1 & 0 \\ 0 & 1 \end{bmatrix} \begin{bmatrix} z_1 \\ z_2 \end{bmatrix}. \end{aligned}$$

Since $\det \left(\begin{bmatrix} q+1 & -q \\ -1 & 1 \end{bmatrix} \right) = 1 \neq 0$, this is a well-defined polynomial matrix description for the closed-loop system. Note that the transfer function matrix of the closed-loop system is $H(s) = \begin{bmatrix} 1 & 0 \\ 0 & 1 \end{bmatrix} \begin{bmatrix} s+1 & -s \\ -1 & 1 \end{bmatrix}^{-1} \begin{bmatrix} s & 0 \\ 0 & 1 \end{bmatrix} = \begin{bmatrix} s & s \\ s & s+1 \end{bmatrix}$, which is not proper, whereas H_1 and H_2 were both proper.

Now if state-space realizations of $H_1(s) = \frac{-1}{s+1} + 1$ and $H_2(s) = 1$ are considered, namely $\{A_1, B_1, C_1, D_1\} = \{-1, 1, -1, 1\}$ and $\{A_2, B_2, C_2, D_2\} = \{0, 0, 0, 1\}$, then $1 - D_1 D_2 = 1 - 1 \cdot 1 = 0$; i.e., a state-space description of the closed-loop does not exist. This is to be expected since the closed-loop transfer function is nonproper and as such cannot be represented by a state-space realization $\{A, B, C, D\}$.

Next, let $H_1(s)$ and $H_2(s)$ be the transfer function matrices of S_1 and S_2 ; i.e., $\hat{y}_1(s) = H_1(s)\hat{u}_1(s)$ and $\hat{y}_2(s) = H_2(s)\hat{u}_2(s)$. In view of $\hat{u}_1 = \hat{y}_2 + \hat{r}_1$ and $\hat{u}_2 = \hat{y}_1 + \hat{r}_2$, we have $\hat{y}_1 = H_1\hat{u}_1 = H_1(\hat{y}_2 + \hat{r}_1) = H_1 H_2 \hat{u}_2 + H_1 \hat{r}_1 = H_1 H_2 \hat{y}_1 + H_1 H_2 \hat{r}_2 + H_1 \hat{r}_1$ or

$$(I - H_1 H_2)\hat{y}_1 = H_1 H_2 \hat{r}_2 + H_1 \hat{r}_1. \tag{10.17}$$

Also, $\hat{y}_2 = H_2 \hat{u}_2 = H_2(\hat{y}_1 + \hat{r}_2) = H_2 H_1 \hat{u}_1 + H_2 \hat{r}_2 = H_2 H_1 \hat{y}_2 + H_2 H_1 \hat{r}_1 + H_2 \hat{r}_2$ or

$$(I - H_2 H_1)\hat{y}_2 = H_2 H_1 \hat{r}_1 + H_2 \hat{r}_2. \tag{10.18}$$

Note that $\det(I - H_1 H_2) = \det(I - H_2 H_1)$, and assume that the determinant is nonzero. Then

$$\begin{aligned} \begin{bmatrix} \hat{y}_1 \\ \hat{y}_2 \end{bmatrix} &= \begin{bmatrix} (I - H_1 H_2)^{-1} H_1 & (I - H_1 H_2)^{-1} H_1 H_2 \\ (I - H_2 H_1)^{-1} H_2 H_1 & (I - H_2 H_1)^{-1} H_2 \end{bmatrix} \begin{bmatrix} \hat{r}_1 \\ \hat{r}_2 \end{bmatrix} \\ &= \begin{bmatrix} H_{11} & H_{12} \\ H_{21} & H_{22} \end{bmatrix} \begin{bmatrix} \hat{r}_1 \\ \hat{r}_2 \end{bmatrix}. \end{aligned} \tag{10.19}$$

The significance of the assumption $\det(I - H_1H_2) \neq 0$ can be seen as follows. Let $\tilde{D}_1\tilde{z}_1 = \tilde{N}_1u_1$, $y_1 = \tilde{z}_1$ and $D_2z_2 = u_2$, $y_2 = N_2z_2$ be representations of the systems S_1 and S_2 . As will be shown below, the closed-loop system description in this case is given by $(\tilde{D}_1D_2 - \tilde{N}_1N_2)z_2 = \tilde{N}_1r_1 + \tilde{D}_1r_2$ and $y_1 = D_2z_2 - r_2$ and $y_2 = N_2z_2$. Now note that $I - H_1H_2 = I - \tilde{D}_1^{-1}\tilde{N}_1N_2D_2^{-1} = \tilde{D}_1^{-1}(\tilde{D}_1D_2 - \tilde{N}_1N_2)D_2^{-1}$, which implies that $\det(I - H_1H_2) \neq 0$ if and only if $\det(\tilde{D}_1D_2 - \tilde{N}_1N_2) \neq 0$; i.e., if $\det(I - H_1H_2) = 0$, then the closed-loop system cannot be described by the polynomial matrix representations discussed in this chapter. Thus, the assumption that $\det(I - H_1H_2) \neq 0$ is essential for the closed-loop system to be well defined.

Example 10.2. Consider $H_1(s) = \frac{s}{s+1}$ and $H_2(s) = 1$ as in Example 10.1. Here $1 - H_1H_2 = \frac{1}{s+1} \neq 0$, and therefore, the closed-loop system is well defined. Relation (10.19) assumes in this case the form

$$\begin{bmatrix} \hat{y}_1 \\ \hat{y}_2 \end{bmatrix} = \begin{bmatrix} s & s \\ s & s+1 \end{bmatrix} \begin{bmatrix} \hat{r}_1 \\ \hat{r}_2 \end{bmatrix},$$

a nonproper transfer function that is the transfer function matrix $H(s)$ derived in Example 10.1.

For simplicity, assume that both S_1 and S_2 in Figure 10.3 are controllable and observable and consider the following representations.

For system S_1 :

$$(1a) \quad D_1(q)z_1(t) = u_1(t), \quad y_1(t) = N_1(q)z_1(t) \quad (10.20)$$

or

$$(1b) \quad \tilde{D}_1(q)\tilde{z}_1(t) = \tilde{N}_1(q)u_1(t), \quad y_1(t) = \tilde{z}_1(t), \quad (10.21)$$

where $(D_1(q), N_1(q))$ are rc and $(\tilde{D}_1(q), \tilde{N}_1(q))$ are lc.

For system S_2 :

$$(2a) \quad D_2(q)z_2(t) = u_2(t), \quad y_2(t) = N_2(q)z_2(t) \quad (10.22)$$

or

$$(2b) \quad \tilde{D}_2(q)\tilde{z}_2(t) = \tilde{N}_2(q)u_2(t), \quad y_2(t) = \tilde{z}_2(t), \quad (10.23)$$

where $(D_2(q), N_2(q))$ are rc and $(\tilde{D}_2(q), \tilde{N}_2(q))$ are lc.

In view of the connections

$$u_1(t) = y_2(t) + r_1(t), \quad u_2(t) = y_1(t) + r_2(t), \quad (10.24)$$

the closed-loop feedback system of Figure 10.3 can now be characterized as follows [see also (10.13)]:

(i) Using descriptions (1a) and (2a), and Eqs. 10.20 and 10.21, we have

$$\begin{bmatrix} D_1 & -N_2 \\ -N_1 & D_2 \end{bmatrix} \begin{bmatrix} z_1 \\ z_2 \end{bmatrix} = \begin{bmatrix} I & 0 \\ 0 & I \end{bmatrix} \begin{bmatrix} r_1 \\ r_2 \end{bmatrix}, \begin{bmatrix} y_1 \\ y_2 \end{bmatrix} = \begin{bmatrix} N_1 & 0 \\ 0 & N_2 \end{bmatrix} \begin{bmatrix} z_1 \\ z_2 \end{bmatrix}. \quad (10.25)$$

(ii) Using descriptions (1b) and (2b), we have

$$\begin{bmatrix} \tilde{D}_1 & -\tilde{N}_1 \\ -\tilde{N}_2 & \tilde{D}_2 \end{bmatrix} \begin{bmatrix} \tilde{z}_1 \\ \tilde{z}_2 \end{bmatrix} = \begin{bmatrix} \tilde{N}_1 & 0 \\ 0 & \tilde{N}_2 \end{bmatrix} \begin{bmatrix} r_1 \\ r_2 \end{bmatrix}, \begin{bmatrix} y_1 \\ y_2 \end{bmatrix} = \begin{bmatrix} I & 0 \\ 0 & I \end{bmatrix} \begin{bmatrix} \tilde{z}_1 \\ \tilde{z}_2 \end{bmatrix}. \quad (10.26)$$

(iii) Using descriptions (1b) and (2a), we have

$$\begin{bmatrix} \tilde{D}_1 & -\tilde{N}_1 N_2 \\ -I & D_2 \end{bmatrix} \begin{bmatrix} \tilde{z}_1 \\ z_2 \end{bmatrix} = \begin{bmatrix} \tilde{N}_1 & 0 \\ 0 & I \end{bmatrix} \begin{bmatrix} r_1 \\ r_2 \end{bmatrix}, \begin{bmatrix} y_1 \\ y_2 \end{bmatrix} = \begin{bmatrix} I & 0 \\ 0 & N_2 \end{bmatrix} \begin{bmatrix} \tilde{z}_1 \\ z_2 \end{bmatrix}. \quad (10.27)$$

Also, $D_2 z_2 = u_2 = y_1 + r_2 = \tilde{D}_1^{-1} \tilde{N}_1 u_1 + r_2 = \tilde{D}_1^{-1} \tilde{N}_1 (y_2 + r_1) + r_2 = \tilde{D}_1^{-1} \tilde{N}_1 (N_2 z_2 + r_1) + r_2$ and $y_1 = u_2 - r_2 = D_2 z_2 - r_2$, from which we obtain

$$(\tilde{D}_1 D_2 - \tilde{N}_1 N_2) z_2 = [\tilde{N}_1, \tilde{D}_1] \begin{bmatrix} r_1 \\ r_2 \end{bmatrix}, \begin{bmatrix} y_1 \\ y_2 \end{bmatrix} = \begin{bmatrix} D_2 \\ N_2 \end{bmatrix} z_2 + \begin{bmatrix} 0 & -I \\ 0 & 0 \end{bmatrix} \begin{bmatrix} r_1 \\ r_2 \end{bmatrix}. \quad (10.28)$$

(iv) Using descriptions (1a) and (2b), we have

$$\begin{bmatrix} D_1 & -I \\ -\tilde{N}_2 N_1 & D_2 \end{bmatrix} \begin{bmatrix} z_1 \\ \tilde{z}_2 \end{bmatrix} = \begin{bmatrix} I & 0 \\ 0 & \tilde{N}_2 \end{bmatrix} \begin{bmatrix} r_1 \\ r_2 \end{bmatrix}, \begin{bmatrix} y_1 \\ y_2 \end{bmatrix} = \begin{bmatrix} N_1 & 0 \\ 0 & I \end{bmatrix} \begin{bmatrix} z_1 \\ \tilde{z}_2 \end{bmatrix}. \quad (10.29)$$

Also, $D_1 z_1 = u_1 = y_2 + r_1 = \tilde{D}_2^{-1} \tilde{N}_2 u_2 + r_1 = \tilde{D}_2^{-1} \tilde{N}_2 (y_1 + r_2) + r_1 = \tilde{D}_2^{-1} \tilde{N}_2 (N_1 z_1 + r_2) + r_1$ and $y_2 = u_1 - r_1 = D_1 z_1 - r_1$, from which we obtain

$$(\tilde{D}_2 D_1 - \tilde{N}_2 N_1) z_1 = [\tilde{D}_2, \tilde{N}_2] \begin{bmatrix} r_1 \\ r_2 \end{bmatrix}, \begin{bmatrix} y_1 \\ y_2 \end{bmatrix} = \begin{bmatrix} N_1 \\ D_1 \end{bmatrix} z_1 + \begin{bmatrix} 0 & 0 \\ -I & 0 \end{bmatrix} \begin{bmatrix} r_1 \\ r_2 \end{bmatrix}. \quad (10.30)$$

Controllability and Observability

The preceding descriptions of the closed-loop system given in (i), (ii), (iii), and (iv) are equivalent and have the same uncontrollable and unobservable modes. The systems S_1 and S_2 were taken to be controllable and observable, and so the uncontrollability and unobservability discussed below is due to the feedback interconnection only.

Controllability. To study controllability, consider the representation (10.25). It can be seen from the matrices $\begin{bmatrix} D_1 & -N_2 \\ -N_1 & D_2 \end{bmatrix}$ and $\begin{bmatrix} I & 0 \\ 0 & I \end{bmatrix}$ that the eigenvalues that are uncontrollable from r_1 will be the roots of the determinant of a gcd of $[-N_1, D_2]$ and the eigenvalues that are uncontrollable from r_2 will be the roots of a gcd of $[D_1, -N_2]$. The closed-loop system is controllable from $\begin{bmatrix} r_1 \\ r_2 \end{bmatrix}$. Clearly, all possible eigenvalues that are uncontrollable from r_1 are eigenvalues of S_2 . These are the poles of $H_2 = N_2 D_2^{-1}$ that cancel in the product $H_2 N_1$. Similarly, all possible eigenvalues that are uncontrollable from r_2 are eigenvalues of S_1 . These are the poles of $H_1 = N_1 D_1^{-1}$ that cancel in the product $H_1 N_2$.

Observability. To study observability, consider the representation (10.26). From the matrices $\begin{bmatrix} \tilde{D}_1 & -\tilde{N}_1 \\ -\tilde{N}_2 & \tilde{D}_2 \end{bmatrix}$ and $\begin{bmatrix} I & 0 \\ 0 & I \end{bmatrix}$, it can be seen that the eigenvalues that are unobservable from y_1 will be the roots of the determinant of a gcd of $\begin{bmatrix} -\tilde{N}_1 \\ \tilde{D}_2 \end{bmatrix}$ and the eigenvalues that are unobservable from y_2 will be the roots of the determinant of a gcd of $\begin{bmatrix} \tilde{D}_1 \\ -\tilde{N}_2 \end{bmatrix}$. The closed-loop system is observable from $\begin{bmatrix} y_1 \\ y_2 \end{bmatrix}$. Clearly, all possible eigenvalues that are unobservable from y_1 are eigenvalues of S_2 . These are the poles of $H_2 = \tilde{D}_2^{-1} \tilde{N}_2$ that cancel in the product $\tilde{N}_1 H_2$. Similarly, all possible eigenvalues that are unobservable from y_2 are eigenvalues of S_1 . These are the poles of $H_1 = \tilde{D}_1^{-1} \tilde{N}_1$ that cancel in the product $\tilde{N}_2 H_1, H_2[H_1, I]$.

Example 10.3. Consider systems S_1 and S_2 connected in the feedback configuration of Figure 10.3, and let S_1 and S_2 be described by the transfer functions $H_1(s) = \frac{s+1}{s-1}$, and $H_2(s) = \frac{a_1 s + a_0}{s+b}$. For the closed-loop to be well defined, we must have $1 - H_1 H_2 = 1 - \frac{s+1}{s-1} \frac{a_1 s + a_0}{s+b} = \frac{(1-a_1)s^2 + (b-a_1-a_0-1)s - (b+a_0)}{(s-1)(s+b)} \neq 0$. Note that for $a_1 = 1, a_0 = -1$, and $b = 1, H_2 = \frac{s-1}{s+1}$ and $1 - H_1 H_2 = 1 - 1 = 0$. Therefore, these values are not allowed for the parameters if the closed-loop system is to be represented by a PMD. If state-space descriptions are to be used, let $D_1 = \lim_{s \rightarrow \infty} H_1(s) = 1$ and $D_2 = \lim_{s \rightarrow \infty} H_2(s) = a_1$, from which we have $1 - D_1 D_2 = 1 - a_1 \neq 0$ for the closed-loop system to be characterized by a state-space description. Let us assume that $a_1 \neq 1$.

The uncontrollable and unobservable eigenvalues can be determined from a PMD such as (10.28). Alternatively, in view of the discussion just preceding this example, we conclude the following. (i) The eigenvalues that are uncontrollable from r_1 are the poles of H_2 that cancel in $H_2 N_1 = \frac{a_1 s + a_0}{s+b} (s+1)$; i.e.,

there is an eigenvalue that is uncontrollable from r_1 (at -1) only when $b = 1$. If this is the case, -1 is also an eigenvalue that is unobservable from y_1 . (ii) The poles of H_1 that cancel in $H_1 N_2 = \frac{s+1}{s-1}(a_1 s + a_0)$ are the eigenvalues that are uncontrollable from r_2 ; i.e., there is an eigenvalue that is uncontrollable from r_2 (at $+1$) only when $a_0/a_1 = -1$. If this is the case, $+1$ is also an eigenvalue that is unobservable from y_2 .

Stability

The closed-loop feedback system is internally stable if and only if all of its eigenvalues have negative real parts. The closed-loop eigenvalues can be determined from the closed-loop descriptions derived above. First recall the identities

$$\det \begin{bmatrix} A & D \\ C & B \end{bmatrix} = \det(A) \det(B - CA^{-1}D) = \det(B) \det(A - DB^{-1}C), \quad (10.31)$$

where in the first expression it was assumed that $\det(A) \neq 0$ and in the second expression it was assumed that $\det(B) \neq 0$. The proof of this result is immediate from the matrix identities $\begin{bmatrix} I & 0 \\ -CA^{-1} & I \end{bmatrix} \begin{bmatrix} A & D \\ C & B \end{bmatrix} = \begin{bmatrix} A & D \\ 0 & B - CA^{-1}D \end{bmatrix}$ and $\begin{bmatrix} I & -DB^{-1} \\ 0 & I \end{bmatrix} \begin{bmatrix} A & D \\ C & B \end{bmatrix} = \begin{bmatrix} A - DB^{-1}C & 0 \\ C & B \end{bmatrix}$.

We now consider the polynomial matrices $\begin{bmatrix} D_1 - N_2 \\ -N_1 & D_2 \end{bmatrix}$, $\begin{bmatrix} \tilde{D}_1 - \tilde{N}_1 \\ -\tilde{N}_2 & \tilde{D}_2 \end{bmatrix}$, $(\tilde{D}_1 D_2 - \tilde{N}_1 N_2)$, and $(\tilde{D}_2 D_1 - \tilde{N}_2 N_1)$ from the closed-loop descriptions in (i), (ii), (iii), and (iv). Then

$$\begin{aligned} \det \left(\begin{bmatrix} D_1 - N_2 \\ -N_1 & D_2 \end{bmatrix} \right) &= \det(D_1) \det(D_2 - N_1 D_1^{-1} N_2) \\ &= \det(D_1) \det(D_2 - \tilde{D}_1^{-1} \tilde{N}_1 N_2) \\ &= \det(D_1) \det(\tilde{D}_1^{-1}) \det(\tilde{D}_1 D_2 - \tilde{N}_1 N_2) \\ &= \alpha_1 \det(\tilde{D}_1 D_2 - \tilde{N}_1 N_2), \end{aligned} \quad (10.32)$$

where α_1 is a nonzero real number. Also

$$\begin{aligned} \det \left(\begin{bmatrix} D_1 - N_2 \\ -N_1 & D_2 \end{bmatrix} \right) &= \det(D_2) \det(D_1 - N_2 D_2^{-1} N_1) \\ &= \det(D_2) \det(D_1 - \tilde{D}_2^{-1} \tilde{N}_2 N_1) \\ &= \det(D_2) \det(\tilde{D}_2^{-1}) \det(\tilde{D}_2 D_1 - \tilde{N}_2 N_1) \\ &= \alpha_2 \det(\tilde{D}_2 D_1 - \tilde{N}_2 N_1), \end{aligned} \quad (10.33)$$

where α_2 is a nonzero real number.

Similarly,

$$\det \left(\begin{bmatrix} \tilde{D}_1 & -\tilde{N}_1 \\ -\tilde{N}_2 & \tilde{D}_2 \end{bmatrix} \right) = \hat{\alpha}_1 \det(\tilde{D}_2 D_1 - \tilde{N}_2 N_1), \quad (10.34)$$

where $\hat{\alpha}_1 = \det(\tilde{D}_1) \det(D_1^{-1})$ is a nonzero real number, and

$$\det \left(\begin{bmatrix} \tilde{D}_1 & -\tilde{N}_1 \\ -\tilde{N}_2 & \tilde{D}_2 \end{bmatrix} \right) = \hat{\alpha}_2 \det(\tilde{D}_1 D_2 - \tilde{N}_1 N_2), \quad (10.35)$$

where $\hat{\alpha}_2 = \det(\tilde{D}_2) \det(D_2^{-1})$ is a nonzero real number. These computations verify that the equivalent representations given by (i), (ii), (iii), and (iv) have identical eigenvalues.

The following theorem presents conditions for the internal stability of the feedback system of Figure 10.3. These conditions are useful in a variety of circumstances. Assume that the systems S_1 and S_2 are controllable and observable and that they are described by (10.20)–(10.23) with transfer function matrices given by

$$H_1 = N_1 D_1^{-1} = \tilde{D}_1^{-1} \tilde{N}_1 \quad (10.36)$$

and

$$H_2 = N_2 D_2^{-1} = \tilde{D}_2^{-1} \tilde{N}_2, \quad (10.37)$$

where the (N_i, D_i) are rc and the $(\tilde{N}_i, \tilde{D}_i)$ are lc for $i = 1, 2$. Let $\alpha_1(s)$ and $\alpha_2(s)$ be the pole (characteristic) polynomials of $H_1(s)$ and $H_2(s)$, respectively. Note that $\alpha_i(s) = k_i \det(D_i(s)) = \tilde{k}_i \det(\tilde{D}_i(s))$, $i = 1, 2$, for some nonzero real numbers k_i, \tilde{k}_i . Consider the feedback system in Figure 10.3.

Theorem 10.4. *The following statements are equivalent:*

(a) *The closed-loop feedback system in Figure 10.3 is internally stable.*

(b) *The polynomial*

(i) $\det \left(\begin{bmatrix} D_1 & -N_2 \\ -N_1 & D_2 \end{bmatrix} \right)$, or

(ii) $\det \left(\begin{bmatrix} \tilde{D}_1 & -\tilde{N}_1 \\ -\tilde{N}_2 & \tilde{D}_2 \end{bmatrix} \right)$, or

(iii) $\det(\tilde{D}_1 D_2 - \tilde{N}_1 N_2)$, or

(iv) $\det(\tilde{D}_2 D_1 - \tilde{N}_2 N_1)$

is Hurwitz; that is, its roots have negative real parts.

(c) *The polynomial*

$$\alpha_1(s) \alpha_2(s) \det(I - H_1(s) H_2(s)) = \alpha_1(s) \alpha_2(s) \det(I - H_2(s) H_1(s)) \quad (10.38)$$

is a Hurwitz polynomial.

(d) The poles of

$$\begin{aligned} \begin{bmatrix} \hat{u}_1 \\ \hat{u}_2 \end{bmatrix} &= \begin{bmatrix} I & -H_2 \\ -H_1 & I \end{bmatrix}^{-1} \begin{bmatrix} \hat{r}_1 \\ \hat{r}_2 \end{bmatrix} \\ &= \begin{bmatrix} (I - H_2 H_1)^{-1} & H_2 (I - H_1 H_2)^{-1} \\ H_1 (I - H_2 H_1)^{-1} & (I - H_1 H_2)^{-1} \end{bmatrix} \begin{bmatrix} \hat{r}_1 \\ \hat{r}_2 \end{bmatrix} \end{aligned} \quad (10.39)$$

are stable; i.e., they have negative real parts.

(e) The poles of

$$\begin{aligned} \begin{bmatrix} \hat{y}_1 \\ \hat{y}_2 \end{bmatrix} &= \begin{bmatrix} -H_2 & I \\ I & -H_1 \end{bmatrix}^{-1} \begin{bmatrix} 0 & H_2 \\ H_1 & 0 \end{bmatrix} \begin{bmatrix} \hat{r}_1 \\ \hat{r}_2 \end{bmatrix} \\ &= \begin{bmatrix} (I - H_1 H_2)^{-1} H_1 & (I - H_1 H_2)^{-1} H_1 H_2 \\ (I - H_2 H_1)^{-1} H_2 H_1 & (I - H_2 H_1)^{-1} H_2 \end{bmatrix} \begin{bmatrix} \hat{r}_1 \\ \hat{r}_2 \end{bmatrix} \end{aligned} \quad (10.40)$$

are stable.

Proof. See [1, p. 583, Theorem 3.15]. ■

Remarks

It is important to consider all four entries in the transfer function (10.40) between $\begin{bmatrix} y_1 \\ y_2 \end{bmatrix}$ and $\begin{bmatrix} r_1 \\ r_2 \end{bmatrix}$ [or in (10.39) between $\begin{bmatrix} u_1 \\ u_2 \end{bmatrix}$ and $\begin{bmatrix} r_1 \\ r_2 \end{bmatrix}$] when considering internal stability. Note that the eigenvalues that are uncontrollable from r_1 or r_2 will not appear in the first or the second column of the transfer matrix, respectively. Similarly, the eigenvalues that are unobservable from y_1 or y_2 will not appear in the first or the second row of the transfer matrix, respectively. Therefore, consideration of the poles of some of the entries only may lead to erroneous results, since possible uncontrollable or unobservable modes may be omitted from consideration, and these may lead to instabilities.

Closed-Loop Characteristic Polynomial. The open-loop characteristic polynomial of the feedback system is $\alpha_1(s)\alpha_2(s)$. The closed-loop characteristic polynomial is a monic polynomial, $\alpha_{cl}(s)$, with roots equal to the closed-loop eigenvalues; i.e., it is equal to any of the polynomials in (b) within a multiplication by a nonzero real number. Then, relation (10.38) implies, in view of (iv), that *the determinant of the return difference matrix $(I - H_1(s)H_2(s))$ is the ratio of the closed-loop characteristic polynomial over the open-loop characteristic polynomial within a multiplication by a nonzero real number.*

Example 10.5. Consider the feedback configuration of Figure 10.3 with $H_1 = \frac{s+1}{s-1}$ and $H_2 = \frac{a_1 s + a_0}{s+b}$ the transfer functions of systems S_1 and S_2 , respectively. Let $a_1 \neq 1$ so that the loop is well defined in terms of state-space representations (and all transfer functions are proper). (See Example 10.3.)

All polynomials in (b) of Theorem 10.4 are equal within a multiplication by a nonzero real number, to the closed-loop characteristic polynomial given by $\alpha_{cl}(s) = s^2 + \frac{b-a_1-a_0-1}{1-a_1}s - \frac{b+a_0}{1-a_1}$. This polynomial must be a Hurwitz polynomial for internal stability. If $\alpha_1(s) = s - 1$ and $\alpha_2(s) = s + b$ are the pole polynomials of H_1 and H_2 , then the polynomial in (c) is given by $\alpha_1(s)\alpha_2(s)(1 - H_1(s)H_2(s)) = (1 - a_1)s^2 + (b - a_1 - a_0 - 1)s - (b + a_0) = (1 - a_1)\alpha_{cl}(s)$, which implies that the return difference $1 - H_1(s)H_2(s) = (1 - a_1)\frac{\alpha_{cl}(s)}{\alpha_1(s)\alpha_2(s)}$. Note that $(1 - H_1H_2)^{-1} = (1 - H_2H_1)^{-1} = \frac{(s-1)(s+b)}{\alpha(s)}$ with $\alpha(s) = (1 - a_1)\alpha_{cl}(s)$ and the transfer function matrix in (d) of Theorem 10.4 is given by

$$\begin{bmatrix} \hat{u}_1 \\ \hat{u}_2 \end{bmatrix} = \begin{bmatrix} \frac{(s-1)(s+b)}{\alpha(s)} & \frac{(s-1)(a_1s+a_0)}{\alpha(s)} \\ \frac{(s+1)(s+b)}{\alpha(s)} & \frac{(s-1)(s+b)}{\alpha(s)} \end{bmatrix} \begin{bmatrix} \hat{r}_1 \\ \hat{r}_2 \end{bmatrix}.$$

The polynomial $\alpha(s)$ has a factor $s + 1$ when $b = 1$. Notice that $\alpha(-1) = 2 - 2b = 0$ when $b = 1$. If this is the case ($b = 1$), then

$$\begin{bmatrix} \hat{u}_1 \\ \hat{u}_2 \end{bmatrix} = \begin{bmatrix} \frac{s-1}{\bar{\alpha}(s)} & \frac{(s-1)(a_1s+a_0)}{\alpha(s)} \\ \frac{s+1}{\bar{\alpha}(s)} & \frac{s-1}{\bar{\alpha}(s)} \end{bmatrix} \begin{bmatrix} \hat{r}_1 \\ \hat{r}_2 \end{bmatrix},$$

where $\alpha(s) = (s + 1)\bar{\alpha}(s)$. Notice that three out of four transfer functions do not contain the pole at -1 in $\bar{\alpha}(s)$. Recall that when $b = 1$, -1 is an eigenvalue that is uncontrollable from the r_1 eigenvalue and it cancels in certain transfer functions as expected (see Example 10.3). Similar results can be derived when $a_0/a_1 = -1$. This illustrates the necessity for considering all the transfer functions between u_1, u_2 and r_1, r_2 when studying the internal stability of the feedback system. Similar results can be derived when considering the transfer functions between y_1, y_2 and r_1, r_2 in (e).

10.3 Parameterization of All Stabilizing Feedback Controllers

In this section, it is shown that all stabilizing feedback controllers can be conveniently parameterized. These parameterizations are very important in control since they are fundamental in methodologies such as the optimal H^∞ approach to control design. Our development builds on the controllability, observability, and particularly the internal stability results introduced in Section 10.2, as well as on Diophantine Equation results [1, Subsection 7.2E]. First, in Subsection 10.3.1, all stabilizing feedback controllers are parameterized, using PMDs. Parameterizations are introduced, using first the polynomial matrix parameters (i) D_k, N_k and \tilde{D}_k, \tilde{N}_k and then the stable rational parameter (ii) $K = N_k D_k^{-1} = \tilde{D}_k^{-1} \tilde{N}_k$. These parameters are very convenient in characterizing stability, but cumbersome when properness of the controller

transfer function is to be guaranteed. A parameterization that uses proper and stable MFDs and involves a proper and stable parameter K' is then introduced in Subsection 10.3.2. This is very convenient when properness of H_2 is to be guaranteed. The parameter K' is closely related to the parameter K used in the second approach enumerated above. This type of parameterization is useful in certain control design methods such as optimal H^∞ control design. Two degrees of freedom feedback controllers offer additional capabilities in control design and are discussed in Subsection 10.3.2. Control problems are also described in this subsection.

In the following discussion, the term “stable system S ” is taken to mean that the eigenvalues of the internal description of system S have negative real parts (in the continuous-time case); i.e., the system S is internally stable. Note that when the transfer functions in (10.39) and (10.40) of the feedback system S are proper, internal stability of S implies bounded-input, bounded-output stability of the feedback system, since the poles of the various transfer functions are a subset of the closed-loop eigenvalues.

10.3.1 Stabilizing Feedback Controllers Using Polynomial MFDs

Now consider systems S_1 and S_2 connected in the feedback configuration shown in Figure 10.3. Given S_1 , it is shown how to parameterize all systems S_2 so that the closed-loop feedback system is internally stable. Thus, if $S_1 = S$, called the *plant*, is a given system to be controlled, then $S_2 = S_c$ is viewed as the *feedback controller* that is to be designed. Presently we provide the parameterizations of all stabilizing feedback controllers.

Theorem 10.6. *Assume that the system S_1 is controllable and observable and is described by the PMD (or PMFD) as (a) $D_1 z_1 = u_1, y_1 = N_1 z_1$ given in (10.20), or by (b) $\tilde{D}_1 \tilde{z}_1 = \tilde{N}_1 u_1, y_1 = \tilde{z}_1$ given in (10.21). Let the pair (D_1, N_1) and the pair $(\tilde{D}_1, \tilde{N}_1)$ be doubly coprime factorizations of the transfer function matrix $H_1(s) = N_1 D_1^{-1} = \tilde{D}_1^{-1} \tilde{N}_1$. That is,*

$$UU^{-1} = \begin{bmatrix} X_1 & Y_1 \\ -\tilde{N}_1 & \tilde{D}_1 \end{bmatrix} \begin{bmatrix} D_1 & -\tilde{Y}_1 \\ N_1 & \tilde{X}_1 \end{bmatrix} = \begin{bmatrix} I & 0 \\ 0 & I \end{bmatrix}, \tag{10.41}$$

where U is a unimodular matrix (i.e., $\det U$ is a nonzero real number) and $X_1, Y_1, \tilde{X}_1, \tilde{Y}_1$ are appropriate matrices. Then all the controllable and observable systems S_2 with the property that the closed-loop feedback system eigenvalues are stable (i.e., they have negative real parts) are described by

$$(a) \quad \tilde{D}_2 \tilde{z}_2 = \tilde{N}_2 u_2, \quad y_2 = \tilde{z}_2, \tag{10.42}$$

where $\tilde{D}_2 = \tilde{D}_k X_1 - \tilde{N}_k \tilde{N}_1$ and $\tilde{N}_2 = -(\tilde{D}_k Y_1 + \tilde{N}_k \tilde{D}_1)$ with $X_1, Y_1, \tilde{N}_1, \tilde{D}_1$ given in (10.41) and the parameters \tilde{D}_k and \tilde{N}_k are selected arbitrarily under

the conditions that \tilde{D}_k^{-1} exists and is stable, and the pair $(\tilde{D}_k, \tilde{N}_k)$ is lc and is such that $\det(\tilde{D}_k X_1 - \tilde{N}_k \tilde{N}_1) \neq 0$.

Equivalently, all stabilizing S_2 can be described by

$$(b) \quad D_2 z_2 = u_2, \quad y_2 = N_2 z_2, \quad (10.43)$$

where $D_2 = \tilde{X}_1 D_k - N_1 N_k$ and $N_2 = -(\tilde{Y}_1 D_k + D_1 N_k)$ with $\tilde{X}_1, \tilde{Y}_1, \tilde{N}_1, \tilde{D}_1$ given in (10.41) and the parameters D_k and N_k are selected arbitrarily under the conditions that D_k^{-1} exists and is stable, and the pair (D_k, N_k) is rc and is such that $\det(\tilde{X}_1 D_k - N_1 N_k) \neq 0$.

Furthermore, the closed-loop eigenvalues are precisely the roots of $\det \tilde{D}_k$ or of $\det D_k$. In addition, the transfer function matrix of S_2 is given by

$$\begin{aligned} H_2 &= -(\tilde{D}_k X_1 - \tilde{N}_k \tilde{N}_1)^{-1} (\tilde{D}_k Y_1 + \tilde{N}_k \tilde{D}_1) \\ &= -(\tilde{Y}_1 D_k + D_1 N_k) (\tilde{X}_1 D_k - N_1 N_k)^{-1}. \end{aligned} \quad (10.44)$$

Proof. The closed-loop description in case (a) is given by (10.30) and in case (b) it is given by (10.28). It can be shown [1, Subsection 7.2E] that the expression in (a) and (b) above can also be written as

$$[\tilde{D}_2, -\tilde{N}_2] = [\tilde{D}_k, \tilde{N}_k] U \quad (10.45)$$

and that

$$\begin{bmatrix} N_2 \\ D_2 \end{bmatrix} = U^{-1} \begin{bmatrix} -N_k \\ D_k \end{bmatrix} \quad (10.46)$$

are parameterizations of all solutions of the *Diophantine equation*

$$\tilde{D}_2 D_1 - \tilde{N}_2 N_1 = \tilde{D}_k \quad (10.47)$$

and

$$\tilde{D}_1 D_2 - \tilde{N}_1 N_2 = D_k, \quad (10.48)$$

respectively, where we let \tilde{D}_k and D_k be desired closed-loop matrices. The fact that \tilde{D}_k^{-1} (or D_k^{-1}) exists and is stable guarantees that all the closed-loop eigenvalues, which are the poles of \tilde{D}_k^{-1} (or of D_k^{-1}), will be stable. The condition $\det(\tilde{D}_k X_1 - \tilde{N}_k \tilde{N}_1) \neq 0$ (or $\det(\tilde{X}_1 D_k - N_1 N_k) \neq 0$) guarantees that $\det \tilde{D}_2 \neq 0$ (or $\det D_2 \neq 0$) and therefore the polynomial matrix description for S_2 in (10.28) is well defined. Finally, note that the pair $(\tilde{D}_k, \tilde{N}_k)$ is lc if and only if the pair $(\tilde{D}_2, \tilde{N}_2)$ is lc as can be seen from $[\tilde{D}_2, -\tilde{N}_2] = [\tilde{D}_k, \tilde{N}_k] U$ given in (10.45) where U unimodular. This then implies that the description $\{\tilde{D}_2, \tilde{N}_2, I\}$ for S_2 is both controllable and observable. Similarly, the pair (D_k, N_k) is rc, which guarantees that $\{D_2, I, N_2\}$ with D_2 and N_2 given in (10.46) is also a controllable and observable description for S_2 . ■

In place of the polynomial matrix parameters \tilde{D}_k, \tilde{N}_k or D_k, N_k , it is possible to use a single parameter, a stable rational matrix K . This is shown next.

Theorem 10.7. *Assume that the system S_1 is controllable and observable and is described by its transfer function matrix*

$$H_1 = N_1 D_1^{-1} = \tilde{D}_1^{-1} \tilde{N}_1, \tag{10.49}$$

where the pairs (N_1, D_1) , $(\tilde{D}_1, \tilde{N}_1)$ are doubly coprime factorizations satisfying (10.41). Then all the controllable and observable systems S_2 with the property that the closed-loop feedback system eigenvalues are stable (i.e., they have strictly negative real parts) are described by the transfer function matrix

$$\begin{aligned} H_2 &= -(X_1 - K\tilde{N}_1)^{-1}(Y_1 + K\tilde{D}_1) \\ &= -(\tilde{Y}_1 + D_1K)(\tilde{X}_1 - N_1K)^{-1}, \end{aligned} \tag{10.50}$$

where the parameter K is an arbitrary rational matrix that is stable and is such that $\det(X_1 - K\tilde{N}_1) \neq 0$ or $\det(\tilde{X}_1 - N_1K) \neq 0$. Furthermore, the poles of K are precisely the closed-loop eigenvalues.

Proof. This is in fact a corollary to Theorem 10.6. It is called a theorem here since it was historically one of the first results established in this area. The parameter K is called the *Youla parameter*.

In Theorem 10.6, descriptions for H_2 were given in (10.44) in terms of the parameters \tilde{D}_k, \tilde{N}_k and D_k, N_k . Now in view of $-\tilde{D}_k N_k + \tilde{N}_k D_k = 0$, we have

$$\tilde{D}_k^{-1} \tilde{N}_k = N_k D_k^{-1} = K, \tag{10.51}$$

which is a stable rational matrix. Since the pair $(\tilde{D}_k, \tilde{N}_k)$ is lc and the pair (N_k, D_k) is rc, they are coprime factorizations for K . Therefore, H_2 in (10.50) can be written as the H_2 of (10.44) given in the previous theorem, from which the controllable and observable internal descriptions for S_2 in (10.42) and (10.43) can immediately be derived. Conversely, (10.50) can immediately be derived from (10.44), using (10.51). Note that the poles of K are the roots of $\det \tilde{D}_k$ or $\det D_k$, which are the closed-loop eigenvalues. ■

Example 10.8. Consider $H_1 = \frac{s+1}{s-1}$. Here $N_1 = \tilde{N}_1 = s + 1$ and $D_1 = \tilde{D}_1 = s - 1$. These are doubly coprime factorizations (a trivial case) since (10.41) is satisfied. We have

$$\begin{aligned} UU^{-1} &= \begin{bmatrix} X_1 & Y_1 \\ -\tilde{N}_1 & \tilde{D}_1 \end{bmatrix} \begin{bmatrix} D_1 & -\tilde{Y}_1 \\ N_1 & \tilde{X}_1 \end{bmatrix} \\ &= \begin{bmatrix} s + \frac{1}{2} & -s + \frac{3}{2} \\ -(s + 1) & s - 1 \end{bmatrix} \begin{bmatrix} s - 1, & -(-s + \frac{3}{2}) \\ s + 1, & s + \frac{1}{2} \end{bmatrix} = \begin{bmatrix} 1 & 0 \\ 0 & 1 \end{bmatrix}. \end{aligned}$$

In view of (10.44) and (10.50), all stabilizing controllers H_2 are then given by

$$H_2 = -\frac{(-s + \frac{3}{2})d_k + (s - 1)n_k}{(s + \frac{1}{2})d_k - (s + 1)n_k} = -\frac{(-s + \frac{3}{2}) + (s - 1)K}{(s + \frac{1}{2}) - (s + 1)K},$$

where $K = n_k/d_k$ is any stable rational function.

Example 10.9. Consider $H_1(s) = [\frac{1}{s^2}, \frac{s+1}{s^2}] = [1, 0] \begin{bmatrix} s^2 & -(s+1) \\ 0 & 1 \end{bmatrix}^{-1} = N_1 D_1^{-1} = \frac{1}{s^2} [1, s+1] = \tilde{D}_1^{-1} \tilde{N}_1$, which are coprime polynomial MFDs. Relation (10.41) is given by

$$\begin{aligned} UU^{-1} &= \begin{bmatrix} X_1 & Y_1 \\ -\tilde{N}_1 & \tilde{D}_1 \end{bmatrix} \begin{bmatrix} D_1 & -\tilde{Y}_1 \\ N_1 & \tilde{X}_1 \end{bmatrix} \\ &= \begin{bmatrix} 1 & s+1 & | & -s^2+1 \\ s & s^2+s+1 & | & -s^3 \\ -1 & -(s+1) & | & -s^2 \end{bmatrix} \begin{bmatrix} s^2 & -(s+1) & | & -(s+1) \\ 0 & 1 & | & -s \\ -1 & 0 & | & -1 \end{bmatrix} \\ &= \begin{bmatrix} 1 & 0 & | & 0 \\ 0 & 1 & | & 0 \\ 0 & 0 & | & 1 \end{bmatrix}. \end{aligned}$$

All stabilizing controllers may then be determined by applying (10.44) or (10.50).

Remark

In [1, pp. 592–605] a complete treatment of several different parameterizations of all stabilizing controllers is given. The first two parameterizations involving D_k and K were presented here. Another interesting parameterization involves Q_1 and Q_2 [1, p. 597], which in the case when the plant is stable, it becomes particularly attractive [1, p. 597, Corollary 4.4].

10.3.2 Stabilizing Feedback Controllers Using Proper and Stable MFDs

In the above development all systems S_2 that internally stabilize the closed-loop feedback system were parametrically characterized. In that development H_1 , the transfer function of S_1 was not necessarily proper and the stabilizing H_2 as well as the closed-loop system transfer function were not necessarily proper either. Recall that a system is said to be internally stable when all of its eigenvalues, which are the roots of its characteristic polynomial, have strictly negative real parts. Polynomial matrix descriptions that can easily handle the case of nonproper transfer functions were used to derive the above results and the case of proper H_1 and H_2 was handled by restricting the parameters used to characterize all stabilizing controllers.

Here we concentrate exclusively on the case of proper transfer functions H_1 of S_1 and parametrically characterize all proper H_2 , which internally stabilize the closed-loop system. For this purpose, proper and stable matrix fractional

descriptions (MFDs) of H_1 and H_2 are used. Such MFDs are now described [1, Subsection 7.4C].

Consider $H(s) \in R(s)^{p \times m}$ to be proper, i.e., $\lim_{s \rightarrow \infty} H(s) < \infty$, and write the MFD as

$$H(s) = N'(s)D'(s)^{-1}, \tag{10.52}$$

where the $N'(s)$ and $D'(s)$ are proper and stable rational matrices that we denote here as $N'(s) \in RH_\infty^{p \times m}$ and $D'(s) \in RH_\infty^{m \times m}$; that is, they are matrices with elements in RH_∞ , the set of all proper and stable rational functions with real coefficients. For instance, if $H(s) = \frac{s-1}{(s-2)(s+1)}$, then $H(s) = \left[\frac{s-1}{(s+2)(s+3)} \right] \left[\frac{(s-2)(s+1)}{(s+2)(s+3)} \right]^{-1} = \left[\frac{s-1}{(s+1)^2} \right] \left[\frac{s-2}{s+1} \right]^{-1}$ are examples of proper and stable MFDs.

A pair $(N', D') \in RH_\infty$ is called *right coprime (rc) in RH_∞* if there exists a pair $(X', Y') \in RH_\infty$ such that

$$X'D' + Y'N' = I. \tag{10.53}$$

This is a *Diophantine Equation* over the ring of proper and stable rational functions. It is also called a *Bezout Identity*.

Let $H = N'D'^{-1}$, and write (10.53) as $X' + Y'H = D'^{-1}$. Since the left-hand side is proper, D'^{-1} is also proper; i.e., in the MFD given by $H = N'D'^{-1}$, where the pair (N', D') is rc, D' is biproper (D' and D'^{-1} are both proper).

Note that X'^{-1} , where X' satisfies (10.53), does not necessarily exist. If, however, H is strictly proper ($\lim_{s \rightarrow \infty} H(s) = 0$), then $\lim_{s \rightarrow \infty} X'(s) = \lim_{s \rightarrow \infty} D'(s)^{-1}$ is a nonzero real matrix, and in this case X'^{-1} exists and is proper; i.e., in this case X' is biproper.

When the Diophantine Equation (10.53) is used to characterize all stabilizing controllers, it is often desirable to have solutions (X', Y') where X' is biproper. This is always possible. Clearly, when H is strictly proper, this is automatically true, as was shown. When H is not strictly proper, however, care should be exercised in the selection of the solutions of (10.53).

As in the polynomial case, doubly coprime factorizations in RH_∞ of a transfer function matrix $H_1 = N'_1 D'^{-1}_1 = \widetilde{D}'^{-1}_1 \widetilde{N}'_1$, where $D'_1, N'_1 \in RH_\infty$ and $\widetilde{D}'_1, \widetilde{N}'_1 \in RH_\infty$ are important in obtaining parametric characterizations of all stabilizing controllers. Assume therefore that

$$U'U'^{-1} = \begin{bmatrix} X'_1 & Y'_1 \\ -\widetilde{N}'_1 & \widetilde{D}'_1 \end{bmatrix} \begin{bmatrix} D'_1 & -\widetilde{Y}'_1 \\ N'_1 & \widetilde{X}'_1 \end{bmatrix} = \begin{bmatrix} I & 0 \\ 0 & I \end{bmatrix}, \tag{10.54}$$

where U' is unimodular in RH_∞ , i.e., U' and $U'^{-1} \in RH_\infty$. Also, assume that X'_1 and \widetilde{X}'_1 have been selected so that $\det X'_1 \neq 0$ and $\det \widetilde{X}'_1 \neq 0$.

Internal Stability

Consider now the feedback system in Figure 10.3, and let H_1 and H_2 be the transfer function matrices of S_1 and S_2 , respectively, which are assumed

to be controllable and observable. Internal stability of a system can be defined in a variety of equivalent ways in terms of the internal description of the system. For example, in this chapter, polynomial matrix internal descriptions were used and the system was considered as being internally stable when its eigenvalues were stable; i.e., they have negative real parts. In Theorem 10.4, it was shown that the closed-loop feedback system is internally stable if and only if the transfer function between $\begin{bmatrix} u_1 \\ u_2 \end{bmatrix}$ and $\begin{bmatrix} r_1 \\ r_2 \end{bmatrix}$ or $\begin{bmatrix} y_1 \\ y_2 \end{bmatrix}$ and $\begin{bmatrix} r_1 \\ r_2 \end{bmatrix}$ have stable poles, i.e., if and only if the poles of $\begin{bmatrix} I & -H_2 \\ -H_1 & I \end{bmatrix}^{-1}$ or $\begin{bmatrix} -H_2 & I \\ I & -H_1 \end{bmatrix}^{-1} \begin{bmatrix} 0 & H_1 \\ H_1 & 0 \end{bmatrix}$, respectively, are stable.

In this section we shall regard the feedback system to be internally stable when

$$\begin{bmatrix} I & -H_2 \\ -H_1 & I \end{bmatrix}^{-1} \in RH_\infty, \tag{10.55}$$

i.e., when all the transfer function matrices in (10.55) are proper and stable. In this way, internal stability can be checked without necessarily involving internal descriptions of S_1 and S_2 . This approach to stability has advantages since it can be extended to systems other than linear, time-invariant systems.

Theorem 10.10. *Let $H_1 = N'_1 D'^{-1}_1 = \widetilde{D}'^{-1}_1 \widetilde{N}'_1$ be doubly coprime MFDs in RH_∞ . Then the closed-loop feedback system is internally stable if and only if H_2 has an lc MFD in RH_∞ , $H_2 = \widetilde{D}'^{-1}_2 \widetilde{N}'_2$, such that*

$$\widetilde{D}'_2 D'_1 - \widetilde{N}'_2 N'_1 = I, \tag{10.56}$$

or if and only if H_2 has an rc MFD in RH_∞ , $H_2 = N'_2 D'^{-1}_2$, such that

$$\widetilde{D}'_1 D'_2 - \widetilde{N}'_1 N_2 = I. \tag{10.57}$$

Proof. See [1, p. 615, Corollary 4.12]. ■

In the following discussion, all proper stabilizing controllers are now parameterized.

Theorem 10.11. *Let $H_1 = N'_1 D'^{-1}_1 = \widetilde{D}'^{-1}_1 \widetilde{N}'_1$ be doubly coprime MFDs in RH_∞ that satisfy (10.54). Then all H_2 that internally stabilize the closed-loop feedback system are given by*

$$H_2 = -(X'_1 - K' \widetilde{N}'_1)^{-1} (Y'_1 + K' \widetilde{D}'_1) = -(\widetilde{Y}'_1 + D'_1 K') (\widetilde{X}'_1 - N'_1 K')^{-1}, \tag{10.58}$$

where $K' \in RH_\infty$ is such that $(X'_1 - K' \widetilde{N}'_1)^{-1}$ (or $(\widetilde{X}'_1 - N'_1 K')^{-1}$) exists and is proper.

Proof. It can be shown that all solutions of $\widetilde{D}_2 D'_1 - \widetilde{N}_2 N'_1 = I$ are given by

$$[\widetilde{D}'_2, -\widetilde{N}'_2] = [I, K'] \begin{bmatrix} X'_1 & Y'_1 \\ -\widetilde{N}'_1 & \widetilde{D}'_1 \end{bmatrix}, \quad (10.59)$$

where $K' \in RH_\infty$. The proof of this result is similar to the proof of the corresponding result for the polynomial matrix Diophantine Equation. Similarly, all solutions of $\widetilde{D}'_1 D'_2 - N'_1 N'_2 = I$ are given by

$$\begin{bmatrix} N'_2 \\ D'_2 \end{bmatrix} = \begin{bmatrix} D'_1 & -\widetilde{Y}'_1 \\ N'_1 & \widetilde{X}'_1 \end{bmatrix} \begin{bmatrix} -K' \\ I \end{bmatrix}, \quad (10.60)$$

where $K' \in RH_\infty$. The result follows then directly from Theorem 10.10. \blacksquare

The above theorem is a generalization of the Youla parameterization of Theorem 10.7 over the ring of proper and stable rational functions.

It is interesting to note that in view of (10.54), H_2 in (10.58) can be written as follows. Assume that X_1^{-1} and \widetilde{X}_1^{-1} exist. Then

$$\begin{aligned} H_2 &= -(\widetilde{Y}'_1 + X_1'^{-1}(I - Y_1' N_1')K')(\widetilde{X}_1 - N_1' K')^{-1} \\ &= -[\widetilde{Y}'_1 \widetilde{X}'_1{}^{-1}(\widetilde{X}'_1 - N_1' K') + X_1'^{-1} K'](\widetilde{X}_1 - N_1' K')^{-1} \\ &= -\widetilde{Y}'_1 \widetilde{X}'_1{}^{-1} - X_1'^{-1} K'(\widetilde{X}_1 - N_1' K')^{-1} = H_{20} + H_{2a}; \end{aligned} \quad (10.61)$$

i.e., any stabilizing controller H_2 can be viewed as the sum of an initial stabilizing controller $H_{20} = -\widetilde{Y}'_1 \widetilde{X}'_1{}^{-1}$ and an additional controller H_{2a} , which depends on K' . When $K' = 0$, then H_{2a} is zero.

Example 10.12. Let $H_1 = \frac{1}{s-1} = \left(\frac{1}{s+1}\right)\left(\frac{s-1}{s+1}\right)^{-1} = N_1' D_1'^{-1} = \left(\frac{s-1}{s+a}\right)^{-1} \left(\frac{1}{s+a}\right) = \widetilde{D}_1'^{-1} \widetilde{N}_1'$ with $a > 0$, which are doubly coprime factorizations. Note that

$$\begin{bmatrix} X'_1 & Y'_1 \\ -\widetilde{N}'_1 & \widetilde{D}'_1 \end{bmatrix} \begin{bmatrix} D'_1 & -\widetilde{Y}'_1 \\ N'_1 & \widetilde{X}'_1 \end{bmatrix} = \begin{bmatrix} \frac{s+3}{s+2} & \frac{s+5}{s+2} \\ -\frac{1}{s+a} & \frac{s-1}{s+a} \end{bmatrix} \begin{bmatrix} \frac{s-1}{s+1} & -\frac{(s+5)(s+a)}{(s+1)(s+2)} \\ \frac{1}{s+1} & \frac{(s+3)(s+a)}{(s+1)(s+2)} \end{bmatrix} = \begin{bmatrix} 1 & 0 \\ 0 & 1 \end{bmatrix}.$$

All stabilizing H_2 are parametrically characterized by (10.58).

Example 10.13. In the above example $H_2 = -(b+1)$, $b > 0$ characterizes all static stabilizing H_2 . Then for $a = 1$, we have

$$\begin{aligned} K' &= -\left(\frac{s+5}{s+2} - \frac{s+3}{s+2}(b+1)\right) \left(\frac{s-1}{s+1} + \frac{b+1}{s+1}\right)^{-1} \\ &= -\left(\frac{-bs-3b+2}{s+2}\right) \left(\frac{s+b}{s+1}\right)^{-1} = \frac{(s+1)(bs+3b-2)}{(s+2)(s+b)}, \end{aligned}$$

which will yield the desired $H_2 = -(b+1)$. The closed-loop eigenvalue is in this case at $-b$ as can easily be verified.

Parameterizations Using State-Space Descriptions

Consider $H = N'D'^{-1} = \widetilde{D}'^{-1}\widetilde{N}'$, a doubly coprime factorization in RH_∞ ; i.e., (10.54) is satisfied. It is possible to express all proper and stable matrices in (10.54) in terms of the matrices of a state-space realization of the transfer function matrix $H(s)$. In particular, we have the following result.

Lemma 10.14. *Let $\{A, B, C, D\}$ be a stabilizable and detectable realization of $H(s)$, i.e., $H(s) = C(sI - A)^{-1}B + D$, which is also denoted by $H(s) \stackrel{s}{=} \begin{bmatrix} A & B \\ C & D \end{bmatrix}$, and with (A, B) stabilizable and (A, C) detectable. Let F be a state feedback gain matrix such that all the eigenvalues of $A + BF$ have negative real parts, and let K be an observer gain matrix such that all the eigenvalues of $A - KC$ have negative real parts. Define*

$$U' = \begin{bmatrix} X' & Y' \\ -\widetilde{N}' & \widetilde{D}' \end{bmatrix} \stackrel{s}{=} \begin{bmatrix} A - KC' & B - KD & K \\ -F & I & 0 \\ -C & -D & I \end{bmatrix} \quad (10.62)$$

and

$$\widehat{U}' = \begin{bmatrix} D' & -\widetilde{Y}' \\ N' & \widetilde{X}' \end{bmatrix} \stackrel{s}{=} \begin{bmatrix} A + BF' & B - K \\ F & I \\ C + DF' & D & I \end{bmatrix}. \quad (10.63)$$

Then (10.54) holds and $H = N'D'^{-1} = \widetilde{D}'^{-1}\widetilde{N}'$ are coprime factorizations of H .

Proof. Relation (10.54) can be shown to be true by direct computation, which it is left to the reader to verify. Clearly, $U', \widehat{U}' \in RH_\infty$. That N', D' and $\widetilde{D}', \widetilde{N}'$ are coprime is a direct consequence of (10.54). That $N'D'^{-1} = \widetilde{D}'^{-1}\widetilde{N}' = H$ can be shown by direct computation and is left to the reader. ■

In view of Lemma 10.14, U' and $U'^{-1} \in RH_\infty$ in (10.54) can be expressed as

$$U' = \begin{bmatrix} X' & Y' \\ -\widetilde{N}' & \widetilde{D}' \end{bmatrix} = \begin{bmatrix} -F \\ -C \end{bmatrix} [sI - (A - KC)]^{-1} [B - KD, K] + \begin{bmatrix} I & 0 \\ -D & I \end{bmatrix} \quad (10.64)$$

and

$$U'^{-1} = \begin{bmatrix} D' & -\widetilde{Y}' \\ N' & \widetilde{X}' \end{bmatrix} = \begin{bmatrix} F \\ C + DF \end{bmatrix} [sI - (A + BF)]^{-1} [B, -K] + \begin{bmatrix} I & 0 \\ D & I \end{bmatrix}. \quad (10.65)$$

These formulas can be used as follows. A stabilizable and detectable realization $\{A, B, C, D\}$ of $H(s)$ is first determined, and appropriate F and K are found so that $A + BF$ and $A - KC$ have eigenvalues with negative real parts. Then U' and U'^{-1} are calculated from (10.64) and (10.65). Note that

appropriate state feedback gain matrices F and observer gain matrices K can be determined, using the methods discussed in Chapter 9. The matrices F and K may be determined, for example, by solving appropriate optimal linear quadratic control and filtering problems. All proper stabilizing controllers $H_2 = N'_2 D'^{-1}_2 = \widehat{D}'^{-1}_2 \widetilde{N}'_2$ of the plant H_1 are then characterized as in Theorem 10.11.

It can now be shown, in view of Lemma 10.14, that all stabilizing controllers are described by

$$\begin{aligned} \dot{\hat{x}} &= (A + BF - K(C + DF))\hat{x} + Ky + (B - KD)r_1, \\ u &= F\hat{x} + r_1, r_2 = y - (C + DF)\hat{x} - Dr_1, r_1 = K'(q)r_2, \end{aligned} \tag{10.66}$$

which can be rewritten as

$$\begin{aligned} \dot{\hat{x}} &= A\hat{x} + Bu + K(y - (C\hat{x} + Du)), \\ u &= F\hat{x} + K'(q)(y - (C\hat{x} + Du)). \end{aligned} \tag{10.67}$$

Thus, every stabilizing controller is a combination of an asymptotic (full-state, full-order) estimator or observer and a stabilizing state feedback, plus $K'(q)r_2$ with $r_2 = y - (C\hat{x} + Du)$, the output “error” (see Figure 10.4).

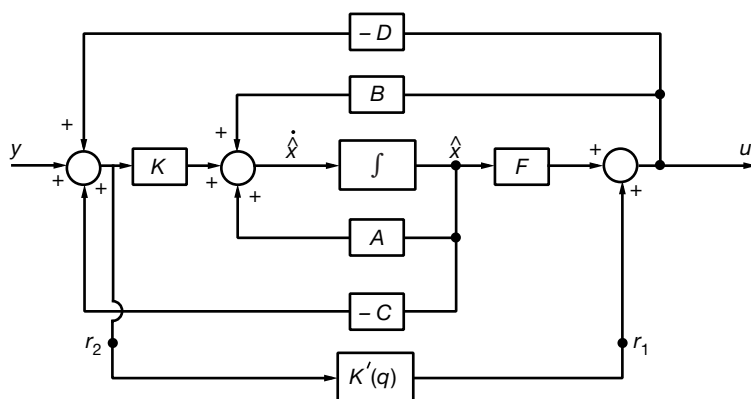

Figure 10.4. A state-space representation of all stabilizing controllers

10.4 Two Degrees of Freedom Controllers

Consider the two degrees of freedom controller S_C in the feedback configuration of Figure 10.5. Here S_H represents the system to be controlled and is described by its transfer function matrix $H(s)$ so that

$$\hat{y}(s) = H(s)\hat{u}(s). \tag{10.68}$$

The two degrees of freedom controller S_C is described by its transfer function matrix $C(s)$ in

$$\hat{u}(s) = C(s) \begin{bmatrix} \hat{y}(s) \\ \hat{r}(s) \end{bmatrix} = [C_y(s), C_r(s)] \begin{bmatrix} \hat{y}(s) \\ \hat{r}(s) \end{bmatrix}. \quad (10.69)$$

Since the controller S_C generates the input u to S_H by processing independently y , the output of S_H , and r , it is called a two degrees of freedom controller.

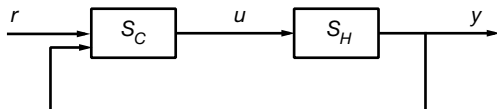

Figure 10.5. Two degrees of freedom controller S_C

In the following discussion, we shall assume that H is a proper transfer function and we shall determine proper controller transfer functions C , which internally stabilize the feedback system in Figure 10.5. The restriction that H and C are proper may easily be removed, if so desired.

10.4.1 Internal Stability

Theorem 10.15. *Given is the proper transfer function H of S_H , and the proper transfer function C of S_C in (10.69) where $\det(I - C_y H) \neq 0$. The closed-loop system in Figure 10.5 is internally stable if and only if*

- (i) $\hat{u} = C_y \hat{y}$ internally stabilizes the system $\hat{y} = H\hat{u}$, and
- (ii) C_r is such that the rational matrix

$$M \triangleq (I - C_y H)^{-1} C_r \quad (10.70)$$

($u = Mr$) satisfies $D^{-1}M = X$, a stable rational matrix, where C_y satisfies (i) and $H = ND^{-1}$ is a right coprime polynomial matrix factorization.

Proof. Consider controllable and observable polynomial matrix descriptions (PMDs) for S_H , given by

$$Dz = u, \quad y = Nz \quad (10.71)$$

and for S_C , given by

$$\tilde{D}_c \tilde{z}_c = [\tilde{N}_y, \tilde{N}_r] \begin{bmatrix} y \\ r \end{bmatrix}, \quad u = \tilde{z}_c, \quad (10.72)$$

where the N, D are rc and the $\tilde{D}_c, [\tilde{N}_y, \tilde{N}_r]$ are lc polynomial matrices. The closed-loop system is then described by

$$(\tilde{D}_c D - \tilde{N}_c N)z = \tilde{N}_r r, y = Nz \quad (10.73)$$

and is internally stable if the roots of $\det \tilde{D}_o$, where $\tilde{D}_o \triangleq \tilde{D}_c D - \tilde{N}_c N$, have negative real parts.

(*Necessity*) Assume that the closed-loop system is internally stable, i.e., \tilde{D}_o^{-1} is stable. Since $C_y = \tilde{D}_c^{-1} \tilde{N}_y$ is not necessarily a left coprime polynomial factorization, write $[\tilde{D}_c, \tilde{N}_y] = G_L[\tilde{D}_{C_y}, \tilde{N}_{C_y}]$, where G_L is a gcd of the pair $(\tilde{D}_c, \tilde{N}_y)$. Then $\tilde{D}_{C_y} D - \tilde{N}_{C_y} N = G_L^{-1} \tilde{D}_o = \tilde{D}_k$, where \tilde{D}_k is a polynomial matrix, with \tilde{D}_k^{-1} stable; note also that G_L^{-1} is stable. Hence, $u = C_y y = \tilde{D}_{C_y}^{-1} \tilde{N}_{C_y} y$ internally stabilizes $y = Hu = ND^{-1}u$; i.e., part (i) of the theorem is true. To show that (ii) is true, we write $M = (I - C_y H)^{-1} C_r = D \tilde{D}_k^{-1} \tilde{D}_{C_y} (\tilde{D}_c^{-1} \tilde{N}_r) = D \tilde{D}_k^{-1} G_L^{-1} \tilde{N}_r = DX$, where $X \triangleq \tilde{D}_o^{-1} \tilde{N}_r$ is a stable rational matrix. This shows that (ii) is also necessary.

(*Sufficiency*) Let C satisfy (i) and (ii) of the theorem. If $C = \tilde{D}_c^{-1}[\tilde{N}_y, \tilde{N}_r]$ is an lc polynomial MFD and G_L is a gcd of the pair $(\tilde{D}_c, \tilde{N}_y)$, then $[\tilde{D}_c, \tilde{N}_y] = G_L[\tilde{D}_{C_y}, \tilde{N}_{C_y}]$ is true for some lc matrices \tilde{D}_{C_y} and \tilde{N}_{C_y} ($C_y = \tilde{D}_{C_y}^{-1} \tilde{N}_{C_y}$). Because (i) is satisfied, $\tilde{D}_{C_y} D - \tilde{N}_{C_y} N = \tilde{D}_k$, where \tilde{D}_k^{-1} is stable. Premultiplying by G_L we obtain $\tilde{D}_c D - \tilde{N}_y N = G_L \tilde{D}_k$. Now if G_L^{-1} is stable, then \tilde{D}_o^{-1} , where $\tilde{D}_o \triangleq \tilde{D}_c D - \tilde{N}_y N = G_L \tilde{D}_k$, will be stable since \tilde{D}_k^{-1} is stable. To show this, write $D^{-1}M = D^{-1}(I - C_y H)^{-1} C_r = \tilde{D}_k^{-1} \tilde{D}_{C_y} (\tilde{D}_c^{-1} \tilde{N}_r) = \tilde{D}_k^{-1} G_L^{-1} \tilde{N}_r$ and note that this is stable, in view of (ii). Observe now that the G_L, \tilde{N}_r are lc; if they were not, then $C = \tilde{D}_c^{-1}[\tilde{N}_y, \tilde{N}_r]$ would not be a coprime factorization. In this case no unstable cancellations take place in $\tilde{D}_k^{-1} G_L^{-1} \tilde{N}_r$ (\tilde{D}_k^{-1} is stable) and therefore, if $D^{-1}M$ is stable, then $(G_L \tilde{D}_k)^{-1} = \tilde{D}_o^{-1}$ is stable or the closed-loop system is internally stable. ■

Remarks

- (i) It is straightforward to show the same results, using proper and stable factorizations of H given by

$$H = N' D'^{-1}, \quad (10.74)$$

where the pair $(N', D') \in RH_\infty$ and (N', D') is rc, and of

$$C = \tilde{D}'_c^{-1}[\tilde{N}'_y, \tilde{N}'_r], \quad (10.75)$$

where the pair $(\tilde{D}'_c, [\tilde{N}'_y, \tilde{N}'_r]) \in RH_\infty$ and $(\tilde{D}'_c, [\tilde{N}'_y, \tilde{N}'_r])$ is lc. The proof is completely analogous and is left to the reader. The only change in the theorem will be in its part (ii), which will now read as follows: C_r is such that the rational matrix $M \triangleq (I - C_y H)^{-1} C_r$ satisfies $D'^{-1}M = X' \in RH_\infty$, where C_y satisfies (a) and $H = N' D'^{-1}$ is an rc MFD in RH_∞ .

(ii) Theorem 10.15 separates the role of C_y , the feedback part of the two degrees of freedom controller C , from the role of C_r , in achieving internal stability. Clearly, if only feedback action is considered, then only part (i) of the theorem is of interest; and if open-loop control is desired, then $C_y = 0$ and (i) implies that for internal stability H must be stable and $C_r = M$ must satisfy part (ii). In (ii) the parameter $M = DX$ appears naturally and in (i) the way is open to use any desired feedback parameterizations. In view of Theorem 10.15 it is straightforward to parametrically characterize all internally stabilizing controllers C . In the theorem it is clearly stated [Part (i)] that C_y must be a stabilizing controller. Therefore, any parametric characterization of the ones developed in the previous subsections, as in [1, Subsection 7.4], can be used for C_y . Also, C_r is expressed in terms of $D^{-1}M = X$ (or $D'^{-1}M = X'$).

Theorem 10.16. *Given that $\hat{y} = H\hat{u}$ is proper with $H = ND^{-1} = \tilde{D}^{-1}\tilde{N}$ doubly coprime polynomial MFDs, all internally stabilizing proper controllers C in $\hat{u} = C \begin{bmatrix} \hat{y} \\ \hat{r} \end{bmatrix}$ are given by*

$$(a) \quad C = (I+QH)^{-1}[Q, M] = [(I+LN)D^{-1}]^{-1}[L, X], \quad (10.76)$$

where $Q = DL$ and $M = DX$ are proper with L, X and $D^{-1}(I + QH) = (I + LN)D^{-1}$ stable, so that $(I + QH)^{-1}$ exists and is proper; or

$$(b) \quad C = (X_1 - K\tilde{N})^{-1}[-(X_2 + K\tilde{D}), X], \quad (10.77)$$

where K and X are stable so that $(X_1 - K\tilde{N}_1)^{-1}$ exists and C is proper. Also, X_1 and X_2 are determined from $UU^{-1} = \begin{bmatrix} X_1 & X_2 \\ -\tilde{N} & \tilde{D} \end{bmatrix} \begin{bmatrix} D - \tilde{X}_2 \\ N & \tilde{X}_1 \end{bmatrix} = \begin{bmatrix} I & 0 \\ 0 & I \end{bmatrix}$ with U unimodular.

If $H = N'D'^{-1} = \tilde{D}'^{-1}\tilde{N}'$ are doubly coprime MFDs in RH_∞ , then all stabilizing proper C are given by

$$(c) \quad C = (X'_1 - K'\tilde{N}')^{-1}[-(X'_2 + K'\tilde{D}'), X'], \quad (10.78)$$

where $K', X' \in RH_\infty$ so that $(X'_1 - K'\tilde{N}')^{-1}$ exists and is proper. Also, $U'U'^{-1} = \begin{bmatrix} X'_1 & X'_2 \\ -\tilde{N}' & \tilde{D}' \end{bmatrix} \begin{bmatrix} D' - \tilde{X}'_2 \\ N' & \tilde{X}'_1 \end{bmatrix} = \begin{bmatrix} I & 0 \\ 0 & I \end{bmatrix}$ with $U', U'^{-1} \in RH_\infty$.

$$(d) \quad C = (I+QH)^{-1}[Q, M] = [(I+L'N')D'^{-1}]^{-1}[L', X'], \quad (10.79)$$

where $Q = D'L'$, $M = D'X' \in RH_\infty$ with L', X' and $D'^{-1}(I + QH) = (I + L'N')D'^{-1} \in RH_\infty$ so that $(I + QH)^{-1}$ or $(I + L'N')^{-1}$ exists and is proper.

Proof. The proof is based on the parameterizations of Section 10.3. For details, and for additional discussion of the parameters L and L' , see [1, p. 624, Theorem 4.2.2]. ■

Remarks

- (a) In [1, pp. 592–605] a complete treatment of different parameterizations of all stabilizing controllers is given. Parameter K in the theorem above was discussed earlier and parameters Q , X and L are discussed in [1, pp. 597–605].
- (b) Notice that in the above theorem C_y is parameterized by K or Q or L , whereas C_r is parameterized by M or X .

10.4.2 Response Maps

It is straightforward to express the maps between signals of interest of Figure 10.6 in terms of the parameters in Theorem 10.16. For instance, $u = C \begin{bmatrix} y \\ r \end{bmatrix} = [C_y, C_r] \begin{bmatrix} y \\ r \end{bmatrix} = C_y H u + C_r r$, from which we have $u = (I - C_y H)^{-1} C_r r = M r$. (In the following discussion, we will use the symbols u , y , r , etc. instead of \hat{u} , \hat{y} , \hat{r} , etc. for convenience.) If expressions in (d) of Theorem 10.16 are used, then

$$u = D'X'r, \quad \text{and} \quad y = H u = N'D'^{-1}D'X'r = N'X'r \tag{10.80}$$

in view of $(I - C_y H)^{-1} = D'(I + L'N')D'^{-1}$. Similar results can be derived using the other parameterizations in Theorem 10.16. To determine expressions for other maps of interest in control systems, consider Figure 10.6, where d_u and d_y are assumed to be disturbances at the input and output of the plant H , respectively, and η denotes measurement noise. Then, $u = [C_y, C_r] \begin{bmatrix} y + d_y + \eta \\ r \end{bmatrix} + d_u$, from which we have $u = (I - C_y H)^{-1} [C_r r + C_y d_y + C_y \eta + d_u]$ and $y = H u = H(I - C_y H)^{-1} [C_r r + C_y d_y + C_y \eta + d_u]$.

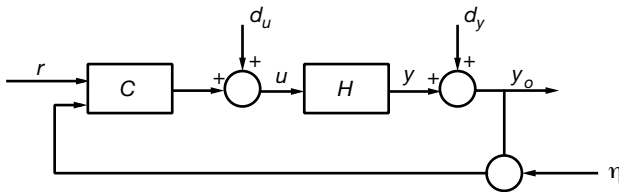

Figure 10.6. Two degrees of freedom control configuration

Then, in view of (10.79) in Theorem 10.16, we obtain

$$\begin{aligned} u &= D'X'r + D'L'd_y + D'L'\eta + D'(I + L'N')D'^{-1}d_u \\ &= M r + Q d_y + Q \eta + S_i d_u \end{aligned} \tag{10.81}$$

and

$$\begin{aligned} y &= N'X'r + N'L'd_y + N'L'\eta + N'(I + L'N')D'^{-1}d_u \\ &= Tr + (S_o - I)d_y + HQ\eta + HS_id_u. \end{aligned} \quad (10.82)$$

Notice that $Q = (I - C_yH)^{-1}C_y = D'L'$ is the transfer function between u and d_y or η . Also,

$$S_i \triangleq (I - C_yH)^{-1} = D'(I + L'N')D'^{-1} = I + QH \quad (10.83)$$

is the transfer function between u and d_u . The matrix S_i is called the *input comparison sensitivity matrix*. Notice also that $y_o = y + d_y = Tr + S_od_y + HQ\eta + HS_id_u$; i.e.,

$$S_o = (I - HC_y)^{-1} = I + HQ \quad (10.84)$$

is the transfer function between y_o and d_y . The matrix S_o is called the *output comparison sensitivity matrix*. The sensitivity matrices S_i and S_o are important quantities in control design. Now

$$S_o - HQ = S_o - N'L' = I \quad (10.85)$$

since $HQ = H(I - C_yH)^{-1}C_y = HC_y(I - HC_y)^{-1} = -I + (I - HC_y)^{-1} = -I + S_o$, where S_o and HQ are the transfer functions from y_o to d_y and η , respectively. Equation (10.85) states that disturbance attenuation (or sensitivity reduction) and noise attenuation cannot occur over the same frequency range. This is a fundamental limitation of the feedback loop and occurs also in two degrees of freedom control systems. Similarly we note that

$$S_i - QH = I. \quad (10.86)$$

We now summarize some of the relations discussed above:

$$\begin{aligned} T &= H(I - C_yH)^{-1}C_r = HM = NX & (y = Tr), \\ M &= (I - C_yH)^{-1}C_r = DX & (u = Mr), \\ Q &= (I - C_yH)^{-1}C_y = DL & (u = Qd_y), \\ S_o &= (I - HC_y)^{-1} = I + HQ & (y_o = S_od_y), \\ S_i &= (I - C_yH)^{-1} = I + QH & (u = S_id_u), \end{aligned}$$

where $y = Tr$ denotes the relation between y and r from (10.82) when all the other signals are zero. Similar expressions hold for the rest of the relations.

Realizing Desired Responses

The input-output maps attainable from r , using an internally stable two degrees of freedom configuration, can be characterized directly. In particular, consider the two maps described by

$$\begin{bmatrix} y \\ u \end{bmatrix} = \begin{bmatrix} T \\ M \end{bmatrix} r, \tag{10.87}$$

i.e., the command/output map T and the command/input map M . Let $H = ND^{-1}$ be an rc polynomial MFD.

Theorem 10.17. *The stable rational function matrices T and M are realizable with internal stability by means of a two degrees of freedom control configuration [which satisfies (10.87)] if and only if there exists a stable X so that*

$$\begin{bmatrix} T \\ M \end{bmatrix} = \begin{bmatrix} N \\ D \end{bmatrix} X. \tag{10.88}$$

Proof. (Necessity) Assume that T and M in (4.169) are realizable with internal stability. Then in view of Theorem 10.15, $X \triangleq D^{-1}M$ is stable. Also, $y = Hu = (ND^{-1})(Mr) = NXr$.

(Sufficiency) Let (10.88) be satisfied. If X is stable, then T and M are stable. Also, note that $T = HM$. We now show that in this case a controller configuration exists to implement these maps (see Figure 10.7). Note that

$$u = \widehat{M}r + C_y(\widehat{T}r + y) = [C_y, \widehat{M} + C_y\widehat{T}] \begin{bmatrix} y \\ r \end{bmatrix},$$

from which we obtain

$$u = (I + C_yH)^{-1}(\widehat{M} + C_y\widehat{T})r. \tag{10.89}$$

Now if $\widehat{M} = M$ and $\widehat{T} = T$, then in view of $T = HM$, this relation implies that $u = (I + C_yH)^{-1}(I + C_yH)Mr = Mr$ and $y = Hu = HMr = Tr$. Furthermore, C_y is a stabilizing feedback controller, and the system is internally stable since \widehat{T} and \widehat{M} are stable. ■

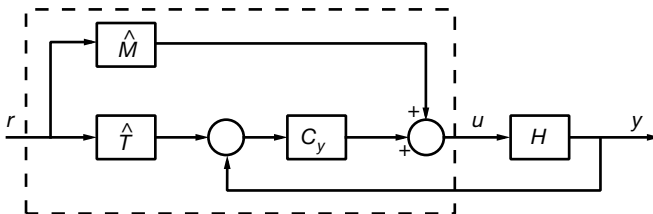

Figure 10.7. Feedback realization of (T, M)

Note that other (than Figure 10.7), internally stable controller configurations to attain these maps are possible. (The realization of both response maps T and M , instead of only T as in the case of the Model Matching Problem, makes the convenient formulation in Theorem 10.17 possible. The realization of both T and M is sometimes referred to as the *Total Synthesis Problem*; see [6], [7] and the references therein.)

The results of Theorem 10.17 can be expressed in terms of $H = N'D'^{-1}$, rc MFDs in RH_∞ . In particular, we have the following result.

Theorem 10.18. $T, M \in RH_\infty$ are realizable with internal stability by means of a two degrees of freedom control configuration [which satisfies (10.87)] if and only if there exists $X' \in RH_\infty$ so that

$$\begin{bmatrix} T \\ M \end{bmatrix} = \begin{bmatrix} N' \\ D' \end{bmatrix} X'. \quad (10.90)$$

Proof. The proof is completely analogous to the proof of Theorem 10.17, and it is omitted. ■

Remarks

- (i) It is now clear that given any desirable response maps $\begin{bmatrix} y \\ u \end{bmatrix} = \begin{bmatrix} T \\ M \end{bmatrix} r$ such that $\begin{bmatrix} T \\ M \end{bmatrix} = \begin{bmatrix} N' \\ D' \end{bmatrix} X'$, where $X' \in RH_\infty$, the pair (T, M) can be realized with internal stability by using for instance a controller (10.79), $C = [(I + L'N')D'^{-1}]^{-1}[L', X']$, where $[(I + L'N')D'^{-1}, L'] \in RH_\infty$ and X' is given above, as can easily be verified. It is clear that there are many C , which realize such T and M , and they are all parameterized via the parameter $L' \in RH_\infty$, which for internal stability must satisfy the condition $(I + L'N')D'^{-1} \in RH_\infty$. Other parameterizations such as K' can also be used. In other words, the maps T, M can be realized by a variety of configurations, each with different feedback properties.
- (ii) In a two degrees of freedom feedback control configuration, all admissible responses from r under condition of internal stability are characterized in terms of the parameters X (or M), whereas all response maps from disturbance and noise inputs that describe feedback properties of the system can be characterized in terms of parameters such as K or Q or L . *This is the fundamental property of two degrees of freedom control systems: It is possible to attain the response maps from r independently from feedback properties such as response to disturbances and sensitivity to plant parameter variations.*

Example 10.19. We consider $H(s) = \frac{(s-1)(s+2)}{(s-2)^2}$ and wish to characterize all proper and stable transfer functions $T(s)$ that can be realized by means of some control configuration with internal stability. Let $H(s) = \frac{s-1}{(s+2)} \left(\frac{(s-2)^2}{(s+2)^2} \right)^{-1} = N'D'^{-1}$ be an rc MFD in RH_∞ . Then in view of Theorem 10.18, all such T must satisfy $N'^{-1}T = \frac{s+2}{s-1}T = X' \in RH_\infty$. Therefore, any proper T with a zero at $+1$ can be realized via a two degrees of freedom feedback controller with internal stability. *In general, all unstable zeros of H must appear in T for internal stability to be possible. This shows a fundamental limitation of feedback control.*

Now if a single degree of freedom controller must be used, the class of realizable $T(s)$ under internal stability is restricted. In particular, if the unity feedback configuration $\{I, G_{ff}, I\}$ in Figure 10.10 below is used, then all proper and stable T that are realizable under internal stability are again given by $T = N'X' = \frac{s-1}{s+2}X'$ where $X' = L' \in RH_\infty$ [see 10.100] and in addition $(I + X'N')D'^{-1} = (1 + X'\frac{s-1}{s+2})\frac{(s+2)^2}{(s-2)^2} \in RH_\infty$; i.e., $X' = n_x/d_x$ is proper and stable and should also satisfy $(s+2)d_x + (s-1)n_x = (s-2)^2p(s)$ for some polynomial $p(s)$. This illustrates the restrictions imposed by the unity feedback controller, as opposed to a two degrees of freedom controller.

It is not difficult to prove the following result.

Theorem 10.20. $T, M, S \in RH_\infty$ are realizable with internal stability by a two degrees of freedom control configuration that satisfy (10.87) and (10.85) [$S = S_o$, see Figure 10.6 and (10.81), (10.82)] if and only if there exist $X', L' \in RH_\infty$ so that

$$\begin{bmatrix} T \\ M \\ S \end{bmatrix} = \begin{bmatrix} N' & 0 \\ D' & 0 \\ 0 & N' \end{bmatrix} \begin{bmatrix} X' \\ L' \end{bmatrix} + \begin{bmatrix} 0 \\ 0 \\ I \end{bmatrix}, \quad (10.91)$$

where $(I + L'N')D'^{-1} \in RH_\infty$. Similarly, $T, M, Q \in RH_\infty$ are realizable if and only if there exist $X', L' \in RH_\infty$ so that

$$\begin{bmatrix} T \\ M \\ Q \end{bmatrix} = \begin{bmatrix} N' & 0 \\ D' & 0 \\ 0 & D' \end{bmatrix} \begin{bmatrix} X' \\ L' \end{bmatrix}, \quad (10.92)$$

where $(I + L'N')D'^{-1} \in RH_\infty$.

Proof. The proof is straightforward in view of Theorem 10.18. Note that S or Q are selected in such a manner that the feedback loop has desirable feedback characteristics that are expressed in terms of these maps. ■

10.4.3 Controller Implementations

The controller $C = [C_y, C_r]$ may be implemented, for example, as a system S_c as shown in Figure 10.5 and described by (10.72); or as shown in Figure 10.7 with $C = [C_y, M + C_yT]$, where C_y stabilizes H and T, M are desired stable maps that relate r to y and r to u ; i.e., $y = Tr$ and $u = Mr$. There are also alternative ways of implementing a stabilizing controller C . In the following discussion, the common control configuration of Figure 10.8, denoted by $\{R; G_{ff}, G_{fb}\}$, is briefly discussed together with several special cases.

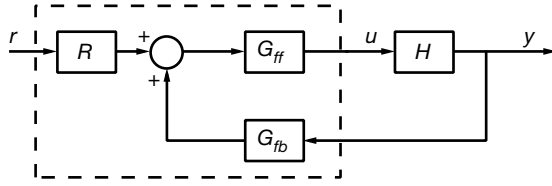

Figure 10.8. Two degrees of freedom controller $\{R; G_{ff}, G_{fb}\}$

$\{R; G_{ff}, G_{fb}\}$ Configuration

Consider the system in Figure 10.8. Note that since

$$u = [C_y, C_r] \begin{bmatrix} y \\ r \end{bmatrix} = [G_{ff}G_{fb}, G_{ff}R] \begin{bmatrix} y \\ r \end{bmatrix}, \tag{10.93}$$

$\{R; G_{ff}, G_{fb}\}$ is a two degrees of freedom control configuration that is as general as the ones discussed before. To see this, let $C = [C_y, C_r] = \widetilde{D}'_c^{-1} [\widetilde{N}'_y, \widetilde{N}'_r]$ be an lc MFD in RH_∞ and let

$$R = \widetilde{N}'_r, G_{ff} = \widetilde{D}'_c^{-1}, G_{fb} = \widetilde{N}'_y. \tag{10.94}$$

Note that R and G_{fb} are always stable; also, G_{ff}^{-1} exists and is stable. Assume now that C was chosen so that

$$\widetilde{D}'_c D' - \widetilde{N}'_y N' = \widetilde{U}', \tag{10.95}$$

where $\widetilde{U}', \widetilde{U}'^{-1} \in RH_\infty$. Then the system in Figure 10.8 with R, G_{ff} and G_{fb} given in (10.94) is internally stable. See [1, p. 630] for the proof of this claim.

We shall now discuss briefly some special cases of the $\{R; G_{ff}, G_{fb}\}$ control configuration, which are quite common in practice. Note that the configurations below are simpler; however, they restrict the choices of attainable response maps and so the flexibility offered to the control designer is reduced.

(i) $\{I; G_{ff}, G_{fb}\}$ Controller

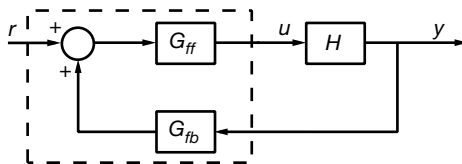

Figure 10.9. The $\{I; G_{ff}, G_{fb}\}$ controller

In this case $u = [C_y, C_r] \begin{bmatrix} y \\ r \end{bmatrix} = [G_{ff}G_{fb}, G_{ff}] \begin{bmatrix} y \\ r \end{bmatrix}$; that is,

$$C_y = C_r G_{fb}. \tag{10.96}$$

See Figure 10.9. In view of (10.79) given in Theorem 10.16, this implies that

$$L' = X' G_{fb} \tag{10.97}$$

or that the choice for the parameters L' and X' is not completely independent as in the $\{R; G_{ff}, G_{fb}\}$ case. The L' and X' must of course satisfy L', X' and $(I + L'N')D'^{-1} \in RH_\infty$. In addition, in this case L' and X' must be so that a proper solution G_{fb} of (10.97) exists and no unstable poles cancel in $X'G_{fb}$. Note that these poles will cancel in the product $G_{ff}G_{fb}$ and will lead to an unstable system. Since L' and X' are both stable, we will require that (10.97) has a solution $G_{fb} \in RH_\infty$. This implies that if, for example, X'^{-1} exists, then X' and L' must be such that $X'^{-1}L' \in RH_\infty$; i.e., the X' and L' have the same unstable zeros and L' is “more proper” than X' . This provides some guidelines about the conditions X' and L' must satisfy. Also,

$$G_{ff} = [(I + L'N')D'^{-1}]^{-1} X'. \tag{10.98}$$

It should be noted that the state feedback law implemented by a dynamic observer can be represented as a $\{I; G_{ff}, G_{fb}\}$ controller. See [1, Section 7.4B, Figure 7.8].

(ii) $\{I; G_{ff}, I\}$ Controller

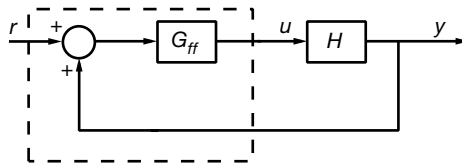

Figure 10.10. The $\{I; G_{ff}, I\}$ controller

A special case of (i) is the common unity feedback control configuration; see Figure 10.10. Here $u = [C_y, C_r] \begin{bmatrix} y \\ r \end{bmatrix} = [G_{ff}, G_{ff}] \begin{bmatrix} y \\ r \end{bmatrix}$; that is,

$$C_r = C_y, \tag{10.99}$$

which in view of (10.79) implies that

$$X' = L'. \tag{10.100}$$

In this case the responses between y or u and r (characterized by X') cannot be designed independently of feedback properties such as sensitivity (characterized by L'). This is a single degree of freedom controller and is used primarily to attain feedback control specifications. This case is discussed further below.

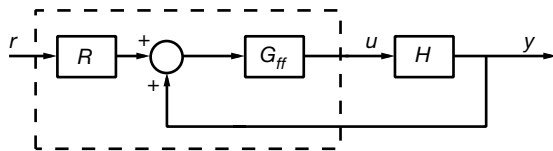

Figure 10.11. The $\{R; G_{ff}, I\}$ controller

(iii) $\{R; G_{ff}, I\}$ Controller

Here $u = [C_y, C_r] \begin{bmatrix} y \\ r \end{bmatrix} = [G_{ff}, G_{ff}R] \begin{bmatrix} y \\ r \end{bmatrix}$; that is,

$$C_r = C_y R. \tag{10.101}$$

See Figure 10.11. In view of (10.79) given in Theorem 10.16, this implies that

$$X' = L'R. \tag{10.102}$$

The L' and X' must satisfy $L', X', (I + L'N')D'^{-1} \in RH_\infty$. In addition, they must be such that (10.102) has a solution $R \in RH_\infty$. Note that R stable is necessary for internal stability. The reader should refer to the discussion in (i) above for the implications of such assumptions on X' and L' . Also,

$$G_{ff} = [(I + L'N')D'^{-1}]^{-1}L'. \tag{10.103}$$

(iv) $\{R; I, G_{fb}\}$ Controller

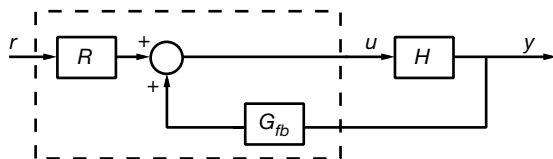

Figure 10.12. The $\{R; I, G_{fb}\}$ controller

In this case

$$u = [C_y, C_r] \begin{bmatrix} y \\ r \end{bmatrix} = [G_{fb}, R] \begin{bmatrix} y \\ r \end{bmatrix}. \tag{10.104}$$

See Figure 10.12. For internal stability, R must be stable. In view of (10.79) given in Theorem 10.16, this implies the requirement $[(I + L'N')D'^{-1}]^{-1}X' \in RH_\infty$, in addition to $L', X', (I + L'N')D^{-1} \in RH_\infty$, which imposes significant additional restrictions on L' . Here

$$[G_{fb}, R] = [(I + L'N')D'^{-1}]^{-1}[L', X']. \tag{10.105}$$

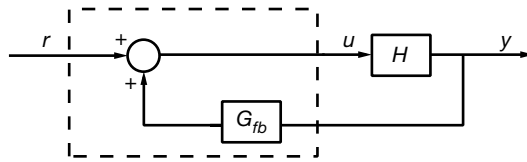

Figure 10.13. The $\{I; I, G_{fb}\}$ controller

(v) $\{I; I, G_{fb}\}$ Controller

This is a special case of (iv), a single degree of freedom case where $R = I$; see Figure 10.13. Here, $R = I$ implies that

$$X' = (I + L'N')D'^{-1}, \tag{10.106}$$

or that, X' and L' must satisfy additionally the relation

$$D'X' - L'N' = I, \tag{10.107}$$

a (skew) Diophantine Equation. This is in addition to the condition that $L', X', (I + L'N')D^{-1} \in RH_\infty$.

Unity (Error) Feedback Configuration

Consider the unity feedback (error feedback) control system depicted in Figure 10.14, where H and C are the transfer function matrices of the plant and controller, respectively [see also Figure 10.10 and (10.99), (10.100)]. This configuration is studied further below.

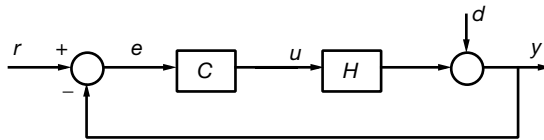

Figure 10.14. Unity feedback control system

Assume that $(I + HC)^{-1}$ exists. It is not difficult to verify the relations

$$\begin{aligned} y &= (I + HC)^{-1}HCr + (I + HC)^{-1}d \triangleq Tr + Sd, \\ u &= (I + CH)^{-1}Cr - (I + CH)^{-1}Cd \triangleq Mr - Md. \end{aligned} \tag{10.108}$$

If they are compared with relations (10.81)–(10.86) for the two degrees of freedom controller, then $u = C_y y + C_r r$, $C_y = -C$ and $C_r = C$, since $u = -C_y y + C_r r$. Hence, for the error feedback system of Figure 10.14, the relations following (10.86) assume the forms

$$\begin{aligned}
M &= (I + CH)^{-1}C = DX = -Q = -DL, \\
T &= H(I + CH)^{-1}C = (I + HC)^{-1}HC = HM = NX, \\
S_o &= (I + HC)^{-1} = I + HQ = I - HM = I - T, \\
S_i &= (I + CH)^{-1} = I + QH = I - MH.
\end{aligned} \tag{10.109}$$

If now Theorem 10.16 is applied to the present error feedback case, then it can be seen that all stabilizing controllers are given by

$$C = [(I - XN)D^{-1}]^{-1}X, \tag{10.110}$$

where $[(I - XN)D^{-1}, X]$ is stable and $(I - XN)^{-1}$ exists. $H = ND^{-1}$ is a right coprime (rc) polynomial matrix factorization.

Similarly, it can be shown by applying Theorem 10.16 that if H is proper and $H = N'D'^{-1}$ is an rc MFD in RH_∞ , then all proper stabilizing controllers are given by

$$C = [(I - X'N')D'^{-1}]^{-1}X', \tag{10.111}$$

where $[(I - X'N')D'^{-1}, X'] \in RH_\infty$ and $(I - X'N')^{-1}$ exists and is proper.

H Square and Nonsingular

Assume now that H is proper and H^{-1} exists; i.e., H is square and nonsingular. Let $H = ND^{-1}$ be an rc polynomial MFD. If T is the closed-loop transfer function between y and r , it can be shown that the system will be internally stable if and only if

$$[N^{-1}(I - T)H, N^{-1}T] \tag{10.112}$$

is stable. Assume that $T \neq I$ in order for the loop to be well defined. Note that if T is proper, then

$$C = H^{-1}T(I - T)^{-1} \tag{10.113}$$

is proper if and only if $H^{-1}T$ is proper and $I - T$ is biproper.

SISO Case

If, in addition, it is assumed that H and T are single-input, single-output transfer functions with $H = n/d$, the closed-loop system will be stable if and only if

$$(1 - T)d^{-1} = Sd^{-1} \quad \text{and} \quad Tn^{-1} \tag{10.114}$$

are stable, i.e., if and only if the sensitivity matrix has as zeros all the unstable poles of the plant and the closed-loop transfer function has as zeros all the unstable zeros of the plant.

This is a result that is well known in the classical control literature (refer to the book by J. R. Ragazzini and G. F. Franklin, *Sampled Data Control Systems*, McGraw-Hill, New York, 1958). It is derived here by specializing the more general multi-input, multi-output case results to the single-input, single-output case.

Example 10.21. Given $H(s) = \frac{s-1}{(s-2)(s+1)}$, all scalar proper transfer functions T that can be realized via the error feedback configuration, shown in Figure 10.14, under internal stability, are to be characterized. When an error feedback configuration is used, T must satisfy the following conditions: $[(1-T)d^{-1}, Tn^{-1}] = \left[\frac{d_T - n_T}{(s-2)(s+1)}, \frac{n_T}{d_T(s-1)} \right]$ stable; that is, T must be stable and $d_T - n_T = (s-2)\hat{d}_T$, $n_T = (s-1)\hat{n}_T$ (T must have as zero the unstable zero of H). The controller $C = \frac{n_T(s-2)(s+1)}{(d_T - n_T)(s-1)} = \frac{\hat{n}_T(s+1)}{\hat{d}_T}$. For C to be proper $H^{-1}T = \frac{(s-2)(s+1)n_T}{(s-1)d_T}$ must be proper and $1 - T = \frac{d_T - n_T}{d_T}$ must be biproper; these are satisfied when $\deg d_T \geq \deg n_T + 1$. The closed-loop eigenvalues are the zeros of $d_c d + n_c n = \hat{d}_T(s-2)(s+1) + \hat{n}_T(s+1)(s-1) = (s+1)[(d_T - n_T) + n_T] = (s+1)d_T$.

If T is to be realized via a two degrees of freedom controller instead, in view of Theorem 10.17, the stability requirement is that $T = NX = (s-1)X$ with X stable.

It may be of interest to use Theorem 10.18 and proper and stable factorizations. In this case, let $H = \frac{s-1}{(s-2)(s+1)} = \left(\frac{s-1}{(s+1)^2} \right) \left(\frac{s-2}{s+1} \right)^{-1}$. Then T is realizable with internal stability using a two degrees of freedom configuration if and only if $N'^{-1}T = \frac{(s+1)^2 n_T}{(s-1)d_T} = X'$ is proper and stable. That is $n_T = (s-1)\hat{n}_T$ and $\deg d_T \geq \deg n_T + 1$. In the error feedback case, $[(1-T)d'^{-1}, Tn'^{-1}] = \left[\frac{(d_T - n_T)(s+1)}{d_T(s-2)}, \frac{n_T(s+1)^2}{d_T(s-1)} \right]$ must be proper and stable, which imply, for stability, that T should be stable, $d_T - n_T = (s-2)\hat{d}_T$, $n_T = (s-1)\hat{n}_T$; and for properness, $\deg d_T \geq \deg n_T + 1$ as before.

10.4.4 Some Control Problems

In control problems, design specifications typically include requirements for internal stability or pole placement, low sensitivity to parameter variations, disturbance attenuation, and noise reduction. Also, requirements such as model matching, diagonal decoupling, static decoupling, regulation, and tracking are included in the specifications.

Internal stability has, of course, been a central theme throughout this book, and in this section, all stabilizing controllers were parameterized. Pole placement was also studied in Chapter 9, using state feedback. Sensitivity and disturbance noise reduction are treated by appropriately selecting the feedback controller C_y . Methodologies to accomplish these control goals, frequently in an optimal way, are developed in many control books. It should be noted that many important design approaches such as the H_∞ optimal control design method are based on the parameterizations of all feedback stabilizing controllers discussed above. In particular, an appropriate or optimal controller

is selected by restricting the parameters used, so that additional control goals are accomplished optimally, while guaranteeing internal stability in the loop.

Our development of the theory of two degrees of freedom controllers can be used directly to study model matching and decoupling, and a brief outline of this approach is given in the following. Note that this does not, by far, constitute a complete treatment of these important control problems, but rather, an illustration of the methodologies introduced in this section.

Model Matching Problem

In the *model matching* problem, the transfer function of the plant $H(s)$ ($y = Hu$) and a desired transfer function $T(s)$ ($y = Tr$) are given and a transfer function $M(s)$ ($u = Mr$) is sought so that

$$T(s) = H(s)M(s). \quad (10.115)$$

Typically, $H(s)$ is proper, and the proper and stable $T(s)$ is to be obtained from $H(s)$ using a controller under the condition of internal stability. Therefore, $M(s)$ can in general not be implemented as an open-loop controller, but rather, as a two degrees of freedom controller. In view of Theorem 10.18, if $H = N'D'^{-1}$ is an rc MFD in RH_∞ , then the pair (T, M) can be realized with internal stability if and only if there exists $X' \in RH_\infty$ so that $\begin{bmatrix} T \\ M \end{bmatrix} = \begin{bmatrix} N' \\ D' \end{bmatrix} X'$. Note that an M that satisfies (10.115) must first be selected (there may be an infinite number of solutions M). In the case when $\det H(s) \neq 0$, T can be realized with internal stability by means of a two degrees of freedom control configuration if and only if $N'^{-1}T = X' \in RH_\infty$ (see Example 10.19). In this case $M = D'X'$. Now if the model matching is to be achieved by a more restricted control configuration, then additional conditions are imposed on T for this to happen, which are expressed in terms of X' (see, for instance, Example 10.19 for the case of the unity feedback configuration).

Decoupling Problem

In the problem of *diagonal decoupling*, $T(s)$ in (10.115) is not completely specified but is required to be diagonal, proper, and stable. In this problem the first input affects only the first output, the second input affects only the second output, and so forth. If $H(s)^{-1}$ exists, then diagonal decoupling under internal stability via a two degrees of freedom control configuration is possible if and only if

$$N'^{-1}T = N'^{-1} \begin{bmatrix} \frac{n_1}{d_1} & & \\ & \ddots & \\ & & \frac{n_m}{d_m} \end{bmatrix} = X' \in RH_\infty, \quad (10.116)$$

where $H = N'D'^{-1}$ is an rc MFD in RH_∞ and $T(s) = \text{diag}[n_i(s)/d_i(s)]$, $i = 1, \dots, m$. It is clear that if $H(s)$ has only stable zeros, then no additional restrictions are imposed on $T(s)$. Relation (10.116) implies restrictions on the zeros of $n_i(s)$ when $H(s)$ has unstable zeros.

It is straightforward to show that if diagonal decoupling is to be accomplished by means of more restricted control configurations, then additional restrictions will be imposed on $T(s)$ via X' . (See Exercise 10.5 below for the case of diagonal decoupling via linear state feedback.) A problem closely related to the diagonal decoupling problem is the problem of the *inverse* of $H(s)$. In this case, $T(s) = I$.

In the problem of *static decoupling*, $T(s) \in RH_\infty^m$ is square and also satisfies $T(0) = \Lambda$, a real nonsingular diagonal matrix. An example of such $T(s)$ is $T(s) = \frac{1}{d(s)} \begin{bmatrix} s^2 + 1 & s(s^2 + 2) \\ s(s + 2) & s^2 + 3s + 1 \end{bmatrix}$, where $d(s)$ is a Hurwitz polynomial. Note that if $T(0) = \Lambda$, then a step change in the first input r will affect only the first output in y at steady-state and so forth. Here $y = Tr = T \frac{1}{s} r$ and $\lim_{s \rightarrow 0} sT \frac{1}{s} r = T(0)r = \Lambda r$, which is diagonal and nonsingular. For this to happen, with internal stability when $H(s)$ is nonsingular (see Theorem 10.18), we must have $N'^{-1}T = X' \in RH_\infty$, from which can be seen that static decoupling is possible if and only if $H(s)$ does not have zeros at $s = 0$. If this is the case and if in addition $H(s)$ is stable, static decoupling can be achieved with just a precompensation by a real gain matrix G where $G = H^{-1}(0)\Lambda$. In this case $T(s) = H(s)G = H(s)H^{-1}(0)\Lambda$ from which $T(0) = \Lambda$.

10.5 Summary and Highlights

Interconnected Systems—Feedback

- Let $y = H_1u$ and $u = H_2y + r$, where the plant $H_1 = N_1D_1^{-1}$, and the controller $H_2 = \tilde{D}_2^{-1}\tilde{N}_2$ are both coprime MFD. Then the closed-loop system is stable if and only if $\det(\tilde{D}_2D_1 - \tilde{N}_2N_1)$ is a Hurwitz polynomial or the poles of $\begin{bmatrix} I & -H_2 \\ -H_1 & I \end{bmatrix}^{-1}$ are stable (see Theorem 10.4).
- The Diophantine Equation

$$\tilde{D}_2D_1 - \tilde{N}_2N_1 = \tilde{D}_k$$

is important for feedback systems. The roots of $\det \tilde{D}_k$ are the closed-loop eigenvalues. See (10.30).

- For interconnected systems in parallel and series, see (10.3)–(10.5) and (10.6)–(10.8).

Parameterization of All Stabilizing Feedback Controllers

- Given $H_1 = N_1 D_1^{-1} = \tilde{D}_1^{-1} \tilde{N}_1$, a doubly coprime factorization, all feedback stabilizing controllers H_2 are given by

$$\begin{aligned} H_2 &= -(\tilde{D}_k X_1 - \tilde{N}_k \tilde{N}_1)^{-1} (\tilde{D}_k Y_1 + \tilde{N}_k \tilde{D}_1) \\ &= -(\tilde{Y}_1 D_k + D_1 N_k) (\tilde{X}_1 D_k - N_1 N_k)^{-1}, \end{aligned} \tag{10.44}$$

where

$$UU^{-1} = \begin{bmatrix} X_1 & Y_1 \\ -\tilde{N}_1 & \tilde{D}_1 \end{bmatrix} \begin{bmatrix} D_1 - \tilde{Y}_1 \\ N_1 & \tilde{X}_1 \end{bmatrix} = \begin{bmatrix} I & 0 \\ 0 & I \end{bmatrix} \tag{10.41}$$

with U a unimodular matrix. The polynomial matrices \tilde{N}_k and N_k in

$$\tilde{D}_k^{-1} \tilde{N}_k = N_k D_k^{-1} = K \tag{10.51}$$

are arbitrary and \tilde{D}_k^{-1} , D_k^{-1} stable; the closed-loop eigenvalues are the roots of $\det \tilde{D}_k$ or of $\det D_k$ (see Theorem 10.6).

- Equivalently, all stabilizing controllers are given by

$$\begin{aligned} H_2 &= -(X_1 - K \tilde{N}_1)^{-1} (Y_1 + K \tilde{D}_1) \\ &= -(\tilde{Y}_1 + D_1 K) (\tilde{X}_1 - N_1 K)^{-1}, \end{aligned} \tag{10.50}$$

where the poles of K are the closed-loop eigenvalues (see Theorem 10.7).

- Given $H_1 = N'_1 D'^{-1}_1 = \tilde{D}'^{-1}_1 \tilde{N}'_1$, a doubly coprime MFDs in RH_∞ , then all proper stabilizing controllers H_2 are given by

$$H_2 = -(X'_1 - K' \tilde{N}'_1)^{-1} (Y'_1 + K' \tilde{D}'_1) = -(\tilde{Y}'_1 + D'_1 K') (\tilde{X}'_1 - N'_1 K')^{-1}, \tag{10.58}$$

where $K' \in RH_\infty$, any rational proper and stable matrix (see Theorem 10.11).

- See (10.67) for all stabilizing controllers in terms of state-space descriptions.

Two Degrees of Freedom Controllers

- Given $H = ND^{-1}$ right coprime,

$$\hat{u}(s) = [C_y(s), C_r(s)] \begin{bmatrix} \hat{y}(s) \\ \hat{r}(s) \end{bmatrix} \tag{10.69}$$

stabilizes H if and only if

- (i) $\hat{u} = C_y \hat{y}$ stabilizes $\hat{y} = H \hat{u}$, and
- (ii) C_r is such that

$$M \triangleq (I - C_y H)^{-1} C_r \tag{10.70}$$

($u = Mr$) satisfies $D^{-1}M = X$, a stable rational matrix (see Theorem 10.15).

- See Theorem 10.16 for parameterizations of all stabilizing two degrees of freedom controllers.
- See (10.81) and (10.82) for relations between u , y and external inputs and disturbances.
- Given $y = ND^{-1}u$, $y = Tr$ and $u = Mr$ are realizable via any control configuration with internal stability if and only if

$$\begin{bmatrix} T \\ M \end{bmatrix} = \begin{bmatrix} N \\ D \end{bmatrix} X,$$

where X is stable. See Theorems 10.17 and 10.18.

- The cases when a more restricted controller is used are addressed. See (10.96)–(10.107). The error or unity feedback controller is further discussed in (10.108)–(10.114).
- The model matching problem, the diagonal decoupling problem, and the static decoupling problem are discussed. See Subsection 10.4.4.

10.6 Notes

Two books that are original sources on the use of polynomial matrix descriptions in Systems and Control are Rosenbrock [18] and Wolovich [22]. In the former, what is now called Rosenbrock's matrix is employed and relations to state-space descriptions are emphasized. In the latter, what are now called Polynomial Matrix Fractional Descriptions are emphasized and the relation to state space is accomplished primarily by using controller forms and the Structure Theorem, which was presented in Chap 6. Good general sources for the polynomial matrix description approach include also the books by Vardulakis [19], Kailath [16], and Chen [9]. A good source for the study of feedback systems using PMDs and MFDs is the book by Callier and Desoer [8].

The development of the properties of interconnected systems, addressed in Section 10.2, which include controllability, observability, and stability of systems in parallel, in series, and in feedback configurations is primarily based on the approach taken in Antsaklis and Sain [7], Antsaklis [3] and [4], and Gonzalez and Antsaklis [14].

Parameterizations of all stabilizing controllers are of course very important in control theory today. Historically, their development appears to have evolved in the following manner (see also the historical remarks on the Diophantine Equation in [1, Subsection 7.2E]): Youla et al. [23] introduced the K parameterization (as in Theorem 10.7 above) in 1976 and used it in the Wiener–Hopf design of optimal controllers. This work is considered to be the seminal contribution in this area. The proofs of the results on the parameterizations in Youla et al. [23] involve transfer functions and their characteristic polynomials. Neither the Diophantine Equation nor PMDs of the system are used (explicitly). It should be recalled that in the middle 1970s most of the

control results in the literature concerning MIMO systems involved state-space descriptions and a few employed transfer function matrices. The PMD descriptions of systems were only beginning to make some impact. A version of the linear Diophantine Equation, namely, $AX + YB = C$ polynomial in z^{-1} was used in control design by Kucera in work reported in 1974 and 1975. In that work, parameterizations of all stabilizing controllers were implicit, not explicit, in the sense that the stabilizing controllers were expressed in terms of the general solution of the Diophantine Equation, which in turn can be described parametrically. Explicit parameterizations were reported later in Kucera [17] in 1979. Antsaklis [2] in 1979 introduced the doubly coprime MFDs (used in this book and in the literature) for the first time with the polynomial Diophantine Equation, working over the ring of polynomials, to derive parameterizations of all stabilizing controllers and to prove the results by Youla et al. in an alternative way. In this work, internal system descriptions were connected directly to stabilizing controller parameterizations via the polynomial Diophantine Equation. In Desoer et al. [10] in 1980 parameterizations K' of all stabilizing controllers using coprime MFDs in rings other than polynomial rings (including the ring of proper and stable rational functions) were derived. It should also be noted that proper and stable MFDs had apparently been used earlier by Vidyasagar. In Zames [24] in 1981, a parameterization Q of all stabilizing controllers, but only for stable plants was introduced and used in H_∞ optimal control design. (Similar parameterizations were also used elsewhere, but apparently not to characterize all stabilizing controllers; for example, they were used in the design of the closed-loop transfer function in control systems and in sensitivity studies in the 1950s and 1960s, and also in the “internal model control” studies in chemical process control in the 1980s.) A parameterization X of all stabilizing controllers (where X is closely related to the attainable response in an error feedback control system), valid for unstable plants as well, was introduced in Antsaklis and Sain [6]. Parameterizations involving proper and stable MFDs were further developed in the 1980s in connection with optimal control design methodologies, such as H_∞ optimal control, and connections to state-space approaches were derived. Two degrees of freedom controllers were also studied, and the limitations of the different control configurations became better understood. By now, MDFs and PMDs have become important system representations and their study is essential, if optimal control design methodologies are to be well understood. See [1, Subsections 7.2E and Section 7.6] for further discussion of controller parameterizations.

The material on two degrees of freedom controllers in Section 10.4 is based on Antsaklis [4] and Gonzalez and Antsaklis [12], [13], [14], [15]; a good source for this topic is also Vidyasagar [20]. Note that the main stability theorem (Theorem 10.15) first appeared in Antsaklis [4] and Antsaklis and Gonzalez [5]. For additional material on model matching and decoupling, consult Chen [9], Kailath [16], Falb and Wolovich [11], Williams and Antsaklis [21], and the extensive list of references therein.

References

1. P.J. Antsaklis and A.N. Michel, *Linear Systems*, Birkhäuser, Boston, MA, 2006.
2. P.J. Antsaklis, "Some relations satisfied by prime polynomial matrices and their role in linear multivariable system theory," *IEEE Trans. Auto. Control*, Vol. AC-24, No. 4, pp. 611–616, August 1979.
3. P.J. Antsaklis, *Notes on: Polynomial Matrix Representation of Linear Control Systems*, Pub. No. 80/17, Dept. of Elec. Engr., Imperial College, 1980.
4. P.J. Antsaklis, Lecture Notes of the graduate course, *Feedback Systems*, University of Notre Dame, Spring 1985.
5. P.J. Antsaklis and O.R. Gonzalez, "Stability parameterizations and stable hidden modes in two degrees of freedom control design," *Proc. of the 25th Annual Allerton Conference on Communication, Control and Computing*, pp. 546–555, Monticello, IL, Sept. 30–Oct. 2, 1987.
6. P.J. Antsaklis and M.K. Sain, "Unity feedback compensation of unstable plants," *Proc. of the 20th IEEE Conf. on Decision and Control*, pp. 305–308, Dec. 1981.
7. P.J. Antsaklis and M.K. Sain, "Feedback controller parameterizations: finite hidden modes and causality," in *Multivariable Control: New Concepts and Tools*, S. G. Tzafestas, Ed., D. Reidel Pub., Dordrecht, Holland, 1984.
8. F.M. Callier and C.A. Desoer, *Multivariable Feedback Systems*, Springer-Verlag, New York, NY, 1982.
9. C.T. Chen, *Linear System Theory and Design*, Holt, Reinhart and Winston, New York, NY, 1984.
10. C.A. Desoer, R.W. Liu, J. Murray, and R. Saeks, "Feedback system design: the fractional approach to analysis and synthesis," *IEEE Trans. Auto. Control*, Vol. AC-25, pp. 399–412, June 1980.
11. P.L. Falb and W.A. Wolovich, "Decoupling in the design of multivariable control systems," *IEEE Trans. Auto. Control*, Vol. AC-12, pp. 651–659, 1967.
12. O.R. Gonzalez and P.J. Antsaklis, "Implementations of two degrees of freedom controllers," *Proc. of the 1989 American Control Conference*, pp. 269–273, Pittsburgh, PA, June 21–23, 1989.
13. O.R. Gonzalez and P.J. Antsaklis, "Sensitivity considerations in the control of generalized plants," *IEEE Trans. Auto. Control*, Vol. 34, No. 8, pp. 885–888, August 1989.
14. O.R. Gonzalez and P.J. Antsaklis, "Hidden modes of two degrees of freedom systems in control design," *IEEE Trans. Auto. Control*, Vol. 35, No. 4, pp. 502–506, April 1990.
15. O.R. Gonzalez and P.J. Antsaklis, "Internal models in regulation, stabilization and tracking," *Int. J. Control*, Vol. 53, No. 2, pp. 411–430, 1991.
16. T. Kailath, *Linear Systems*, Prentice-Hall, Englewood Cliffs, NJ, 1980.
17. V. Kucera, *Discrete Linear Control*, Wiley, New York, NY, 1979.
18. H. H. Rosenbrock, *State-Space and Multivariable Theory*, Wiley, New York, NY, 1970.
19. A.I.G. Vardoulakis, *Linear Multivariable Control. Algebraic Analysis and Synthesis Methods*, Wiley, New York, NY, 1991.
20. M. Vidyasagar, *Control System Synthesis. A Factorization Approach*, MIT Press, Cambridge, MA, 1985.
21. T. Williams and P.J. Antsaklis, "Decoupling," *The Control Handbook*, Chapter 50, pp. 745–804, CRC Press and IEEE Press, New York, NY, 1996.

22. W.A. Wolovich, *Linear Multivariable Systems*, Springer-Verlag, New York, NY, 1974.
23. D.C. Youla, H.A. Jabr, and J.J. Bongiorno, Jr., "Modern Wiener-Hopf design of optimal controllers – Part II: The multivariable case," *IEEE Trans. Auto. Control*, Vol. AC-21, pp. 319–338, June 1976.
24. G. Zames, "Feedback and optimal sensitivity: model reference transformations, multiplicative seminorms, and approximate inverses," *IEEE Trans. Auto. Control*, Vol. 26, pp. 301–320, 1981.

Exercises

10.1. Consider the double integrator $H_1 = \frac{1}{s^2}$.

- (a) Characterize all stabilizing controllers H_2 for H_1 .
- (b) Characterize all proper stabilizing controllers H_2 for H_1 of order 1.

10.2. Consider the double integrator $H_1 = \frac{1}{s^2}$.

- (a) Derive a minimal state-space realization for H_1 , and use Lemma 10.14 to derive doubly coprime factorizations in RH_∞ .
- (b) Use the polynomial Diophantine Equations to derive factorizations in RH_∞ .

10.3. Consider $H_1 = \left[\frac{s^2+1}{s^2}, \frac{s+1}{s^3} \right]$.

- (a) Derive a minimal state-space realization $\{A, B, C, D\}$, and use Lemma 10.14 and Theorem 10.11 to parameterize all stabilizing controllers H_2 .
- (b) Derive a stabilizing controller H_2 of order three by appropriately selecting K' . What are the closed-loop eigenvalues in this case? Comment on your results.

10.4. Consider $H = \begin{bmatrix} \frac{1}{s+1} & \frac{2}{s+3} \\ \frac{1}{s+1} & \frac{1}{s+1} \end{bmatrix}$.

- (a) Derive an rc MFD in RH_∞ , $H = N'D'^{-1}$.
- (b) Let $T = \begin{bmatrix} \frac{n_1}{d_1} & 0 \\ 0 & \frac{n_2}{d_2} \end{bmatrix}$, and characterize all diagonal T that can be realized under internal stability via a two degrees of freedom control configuration.

10.5. In the model matching problem, the transfer function matrices $H \in R^{p \times m}(s)$ of the plant and $T \in R^{p \times m}(s)$ of the model must be found so that $T = HM$. M is to be realized via a feedback control configuration under internal stability. Here we are interested in the *model matching problem via linear state feedback*. For this purpose, let $H = ND^{-1}$ an rc polynomial factorization with D column reduced. Then $Dz = u, y = Nz$ is a minimal realization of H . Let the state feedback control law be defined by $u = Fz + Gr$, where $F \in R[s]^{m \times m}$, $G \in R^{m \times m}$ with $\det G \neq 0$ and $\deg_{c_j} F < \deg_{c_j} D$. To

allow additional flexibility, let $r = Kv$ and $K \in R^{m \times q}$. Note that $H_{F,GK} = ND_F^{-1}GK = (ND^{-1})(DD_F^{-1}GK) = (ND^{-1})[D(G^{-1}D_F)^{-1}K] = HM$ where $D_F = D - F$.

In view of the above, solve the model matching problem via linear state feedback, determine F, G , and K , and comment your results when

$$\begin{aligned} \text{(a)} \quad H &= \frac{(s+1)(s+2)}{2s^2-3s+2}, & T &= \frac{s+1}{s+2}, \\ \text{(b)} \quad H &= \begin{bmatrix} \frac{s+1}{s} & 0 \\ \frac{1}{s} & \frac{s+2}{s} \end{bmatrix}, & T &= I_2, \\ \text{(c)} \quad H &= \begin{bmatrix} \frac{s+2}{s+1} & \frac{s+3}{s+2} \\ \frac{1}{s+1} & 0 \end{bmatrix}, & T &= \begin{bmatrix} \frac{s+1}{(s+2)(s+4)} \\ \frac{s+4}{-2} \end{bmatrix}. \end{aligned}$$

Hint: The model matching problem via linear state feedback is quite easy to solve when $p = m$ and $\text{rank } H = m$ in view of $(G^{-1}D_F)^{-1}K = D^{-1}M = D^{-1}H^{-1}T = N^{-1}T$.