

Αλλαγή Μεταβλητής / τών

\mathbb{R}^d (Οι συναρτήσεις είναι βωρεχείς)

$f: [a, b] \rightarrow \mathbb{R}$

$\varphi: [\delta, \delta] \rightarrow [a, b], C^1, \varphi'(t) \neq 0, t \in [\delta, \delta], \underline{\text{επι}}$

$\int_a^b f(x) dx = \int_{\delta}^{\delta} f(\varphi(t)) \cdot |\varphi'(t)| dt$

Τι κρύβεται στο $dx = |\varphi'(t)| dt$;

• $\varphi(t) = ct, c \neq 0$ Γραμμικός μετασχηματισμός (Αλλαγή κλίμακας $c \neq 1$)

$c > 0$

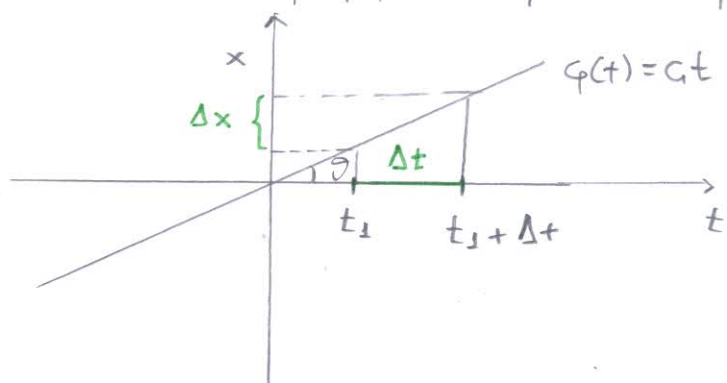

$\Delta x = c \Delta t, \Delta x = \varphi'(t) \Delta t$
 $c = \varepsilon \varphi'$

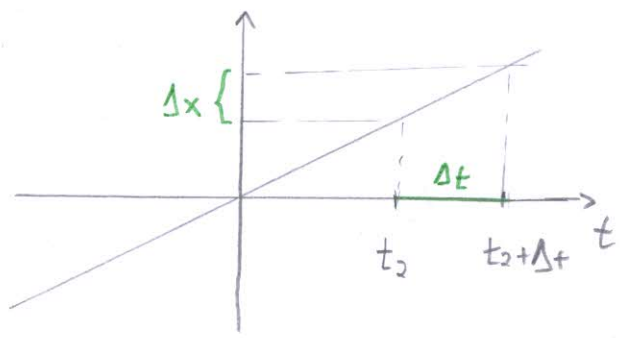

Δx εξαρτάται από το t_1 το Δx !

• $\varphi(t) = t^2, t \in (0, +\infty)$

$\Delta x \cong \varphi'(t_1) \Delta t$

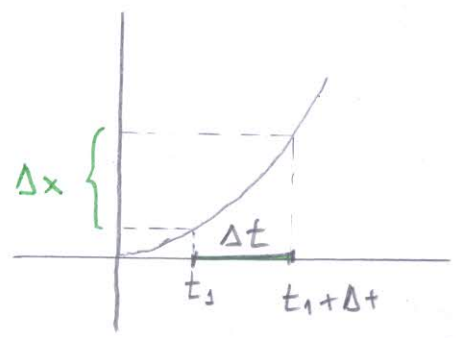

(Εξαρτάται από το t_1)

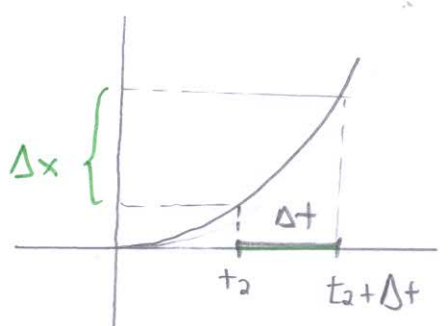

$\Delta x \cong \varphi'(t_2) \Delta t$

$$d=2 \quad \vec{T}(u,v) = \begin{pmatrix} a & \beta \\ \delta & \delta \end{pmatrix} \begin{pmatrix} u \\ v \end{pmatrix} = (au + \beta v, \gamma u + \delta v)$$

$$\det \begin{pmatrix} a & \beta \\ \delta & \delta \end{pmatrix} \neq 0$$

πχ. $\vec{T}(u,v) = \begin{pmatrix} a & 0 \\ 0 & \delta \end{pmatrix}$, $a\delta \neq 0$ πχ $a\delta > 0$ (Διατηρούνται
οι γωνίες / Ορθογώνιος
Μετασχηματισμός)

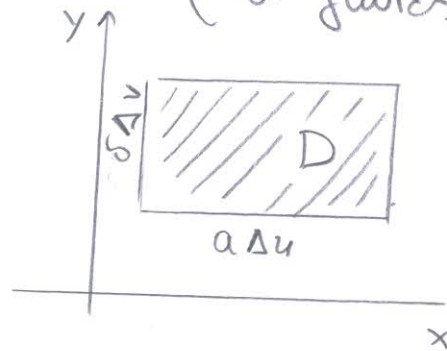
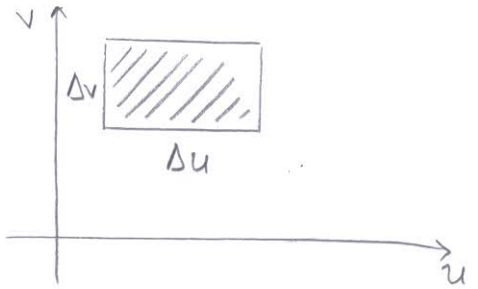

$$\begin{aligned} \Delta x \cdot \Delta y &= (a\delta) \Delta u \cdot \Delta v = \\ &= \left| \det \begin{pmatrix} a & \beta \\ \delta & \delta \end{pmatrix} \right| \Delta u \cdot \Delta v \\ &= \left| \det \vec{J}_{\vec{T}}(u,v) \right| \Delta u \cdot \Delta v \end{aligned}$$

$$\vec{T}(u,v) = \begin{pmatrix} a & \beta \\ \delta & \delta \end{pmatrix} \begin{pmatrix} u \\ v \end{pmatrix}, \det \vec{J}_{\vec{T}}(u,v) \neq 0$$

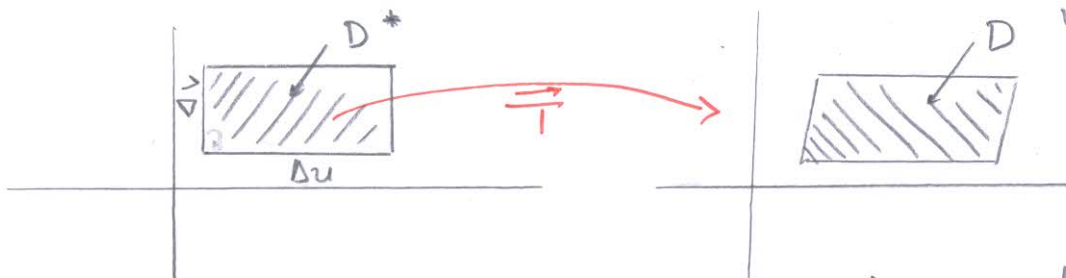

Διατηρείται
η παραλληλία,
αλλάζουν οι γωνίες

$$\Delta x \cdot \Delta y = \left| \det \begin{pmatrix} a & \beta \\ \delta & \delta \end{pmatrix} \right| \Delta u \cdot \Delta v$$

(Άσκηση 5, Φυλλάδιο 1)

$\vec{T}(r, \vartheta) = (r \cos \vartheta, r \sin \vartheta)$, $r \in (0, +\infty)$, $\vartheta \in [0, 2\pi)$ (Μη γραμμικός ως προς ϑ)
 επί του $\mathbb{R}^2 \setminus \{(0,0)\}$, C^1 , 1-1.

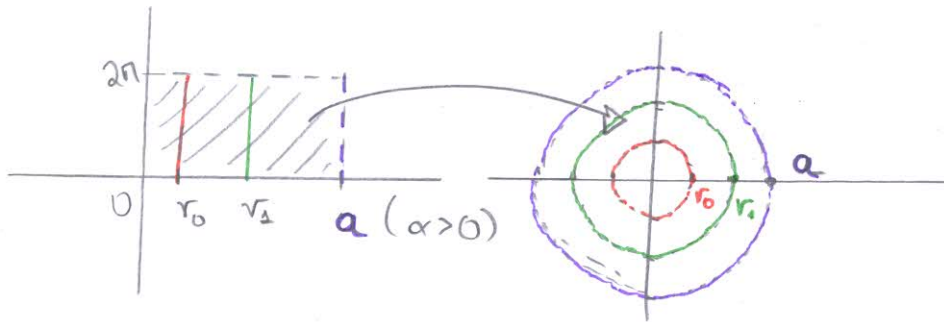

$$\vec{T}(r_0, \vartheta) = (r_0 \cos \vartheta, r_0 \sin \vartheta)$$

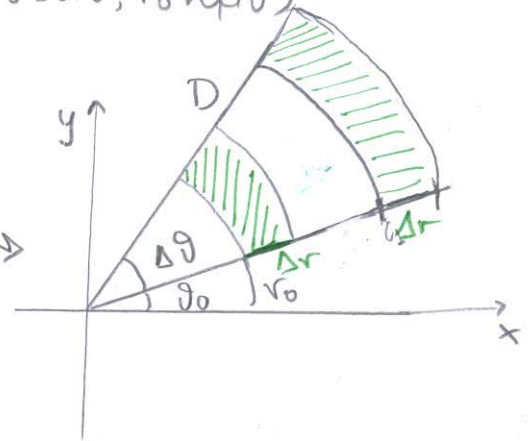
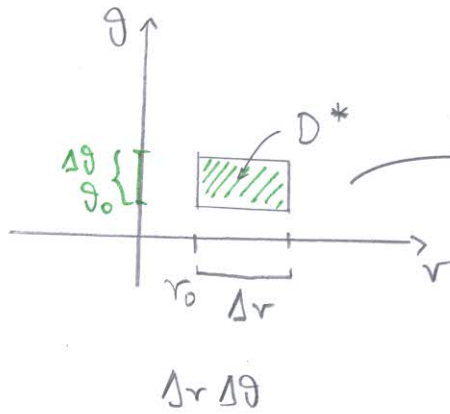

$$\Delta x \cdot \Delta y \cong (r_0 \Delta \vartheta) \Delta r = r_0 \Delta r \Delta \vartheta$$

(Εξαρτάται από το r)

$$\vec{T}(r, \vartheta) = (r \cos \vartheta, r \sin \vartheta)$$

$$J_{\vec{T}}(r, \vartheta) = \begin{pmatrix} \cos \vartheta & -r \sin \vartheta \\ \sin \vartheta & r \cos \vartheta \end{pmatrix}, \det J_{\vec{T}}(r, \vartheta) = r \cos^2 \vartheta + r \sin^2 \vartheta = \underline{\underline{r}}$$

$$f: D \rightarrow \mathbb{R}, \quad D \text{ x-απλό} / f \text{ συνεχής}$$

(x,y)

$$\vec{T}: D^* \rightarrow D \quad C^1, \text{ 1-1, επί, } \det J_{\vec{T}}(u,v) \neq 0$$

(u,v) (x,y) D* u-απλό

Τότε
$$\iint_D f(x,y) dx dy = \iint_{D^*} f(\vec{T}(u,v)) |\det J_{\vec{T}}(u,v)| du dv$$

Συμβολισμός
$$J_{\vec{T}}(u,v) = \frac{\partial(x,y)}{\partial(u,v)}$$

$$\iint_D f(x,y) dx dy = \iint_{D^*} f(\vec{T}(u,v)) \left| \det \frac{\partial(x,y)}{\partial(u,v)} \right| du dv$$

|| υπολογίζουμε με τη βοήθεια Μονού-Διπλού-Τριπλού Ολοκληρώματος;

$\mathbb{R}^d, d=1,2,3,\dots$ / $V_d(K) =: \int_K 1$ όγκος του K (K="καλό" σύνολο)
(οι συναρτήσεις είναι συνεχείς)

• $d=1, f: [a,b] = D_1 \rightarrow \mathbb{R}, f \geq 0$

Μάζα του $[a,b]$ με συνάρτηση πυκνότητας $f(x), x \in [a,b]$

$m =: \int_{D_1} f(x) dx$ (ΚΒ, Ποσές κ.α.)

$V_1(D_1) =: \int_{D_1} 1 = \int_a^b 1 = 1(b-a) = b-a$

Δηλαδή το μήκος του D_1 με το εμβαδόν κυρίου βάρους D_1 και ύψος 1.

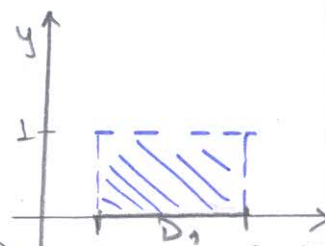

$d=2$ $f: D_2 \rightarrow \mathbb{R}$, $D_2 = \{(x,y) \in \mathbb{R}^2 : x \in D_1, \varphi_1(x) \leq y \leq \varphi_2(x)\}$
 (x -απλό)

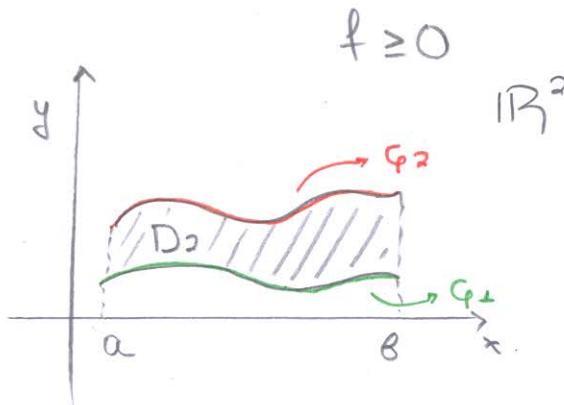

Μάζα του D_2
 $m = \iint_{D_2} f$ (ΚΒ, Ροηές, κ.α)

$$V_2(D_2) = \iint_{D_2} 1 \, dx \, dy = \int_a^b \left(\int_{\varphi_1(x)}^{\varphi_2(x)} 1 \, dy \right) dx = \int_a^b (\varphi_2(x) - \varphi_1(x)) \, dx$$

Δηλαδή, το εμβαδόν του D_2 μπορεί να υπολογιστεί με μονό ή διπλό ολοκλήρωμα.

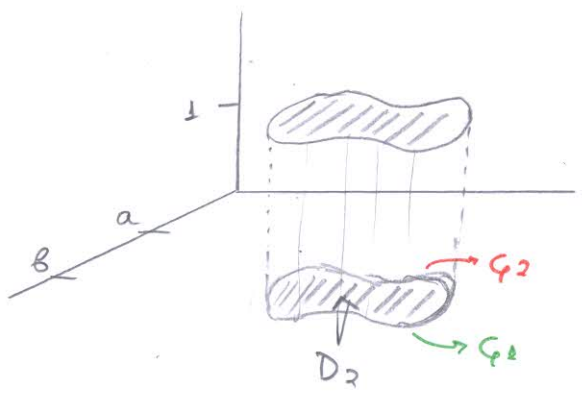

⊕ Δηλαδή, το εμβαδόν του D_2 είναι ίσο με τον όγκο στερεού βάσης D_2 και ύψους 1.

$d=3$, $f: D_3 \rightarrow \mathbb{R}$, $D_3 = \{(x,y,z) : (x,y) \in D_2, h_1(x,y) \leq z \leq h_2(x,y)\}$

$f \geq 0$, $m = \iiint_{D_3} f$ (ΚΒ, Ροηές, κ.α)

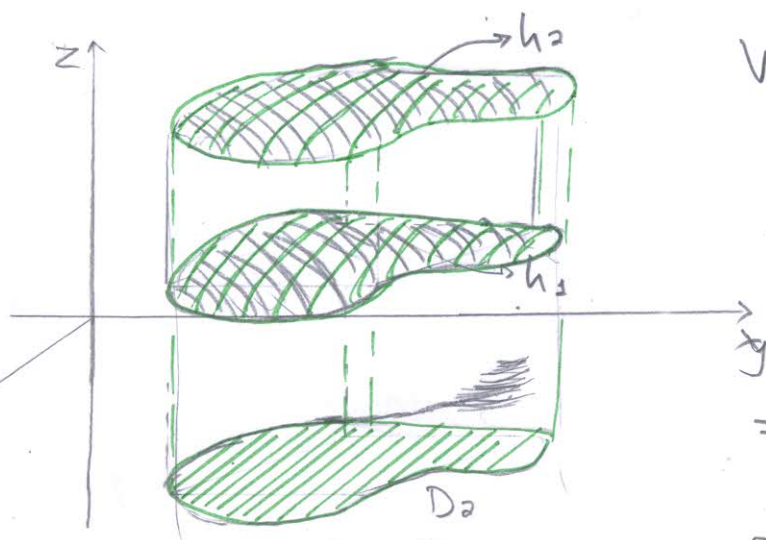

$$V_3(D_3) = \iiint_{D_3} 1 \, dx \, dy \, dz = \iint_{D_2} \left(\int_{h_1(x,y)}^{h_2(x,y)} 1 \, dz \right) dy \, dx = \iint_{D_2} (h_2(x,y) - h_1(x,y)) \, dy \, dx$$

Δηλαδή, ο όγκος του D_3 είναι ίσο με τον 4-όγκο στερεού βάσης D_3 και ύψους 1

1. i) εμβαδόν $A(D)$, $D = \{(x,y) : x^2 + y^2 \leq a^2\}$ ($a > 0$)
 ii) εμβαδόν $A(D)$, $D = \{(x,y) : (\frac{x}{a})^2 + (\frac{y}{b})^2 \leq 1\}$ ($a, b > 0$)
 iii) εμβαδόν $A(K)$, K καρδιοειδής, $K = \{(x,y) : x^2 + y^2 \leq a(\sqrt{x^2 + y^2} + x)\}$
 $a > 0$

Λύση i)

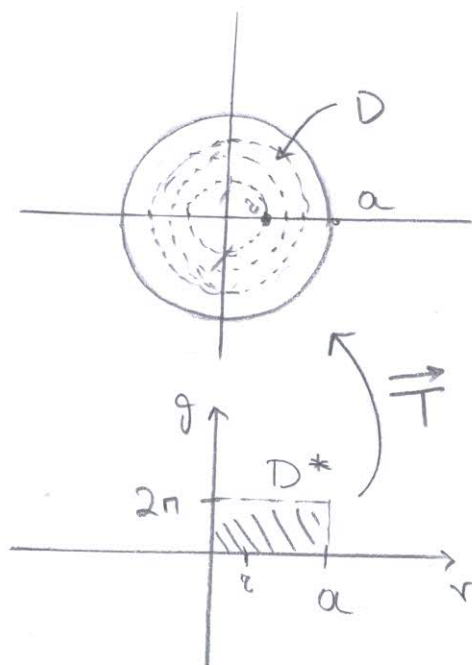

$$D^* = \{(r, \theta) : 0 < r \leq a, 0 \leq \theta \leq 2\pi\}$$

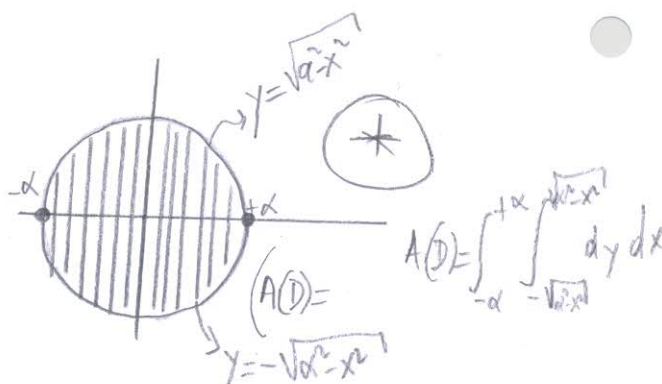

$$A(D) = \iint_D 1 \, dx \, dy = \iint_{D^*} 1 \, |\det J_T(x,y)| \, dr \, d\theta = \int_0^a \left(\int_0^{2\pi} r \, d\theta \right) dr =$$

$$= \int_0^a (2\pi r) \, dr = 2\pi \frac{r^2}{2} \Big|_0^a = \pi a^2$$

ii) $(\frac{x}{a})^2 + (\frac{y}{b})^2 = 1$ $\frac{x}{a} = r \cos \theta, \frac{y}{b} = r \sin \theta$

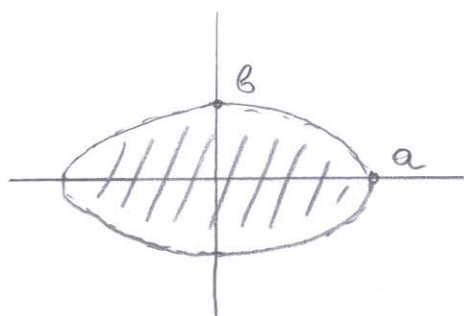

$$T(r, \theta) = (a r \cos \theta, b r \sin \theta) = (x, y)$$

$$\det \frac{\partial(x,y)}{\partial(r,\theta)} = ab r > 0 / D^* = \{(r, \theta) : 0 \leq \theta \leq 2\pi, 0 \leq r \leq 1\}$$

$$A(D) = \int_0^1 \int_0^{2\pi} (ab r) \, d\theta \, dr = ab\pi$$

iii) $x^2 + y^2 = a(\sqrt{x^2 + y^2} + x)$

Παλιό Θέμα.

$$\begin{aligned} x &= r \cos \theta \\ y &= r \sin \theta \end{aligned} \quad \left| \quad \begin{aligned} r^2 &= a(r + r \cos \theta) \\ r &= a(1 + \cos \theta) \end{aligned} \right.$$

$D^* = \{(r, \theta) : 0 \leq \theta \leq 2\pi, 0 \leq r \leq a(1 + \cos \theta)\}$

$A(D) = \iint_D 1 \, dx \, dy = \iint_{D^*} 1 \cdot r \, dr \, d\theta = 2 \int_0^\pi \int_0^{a(1 + \cos \theta)} r \, dr \, d\theta = \dots = \frac{3\pi}{2} a^2$

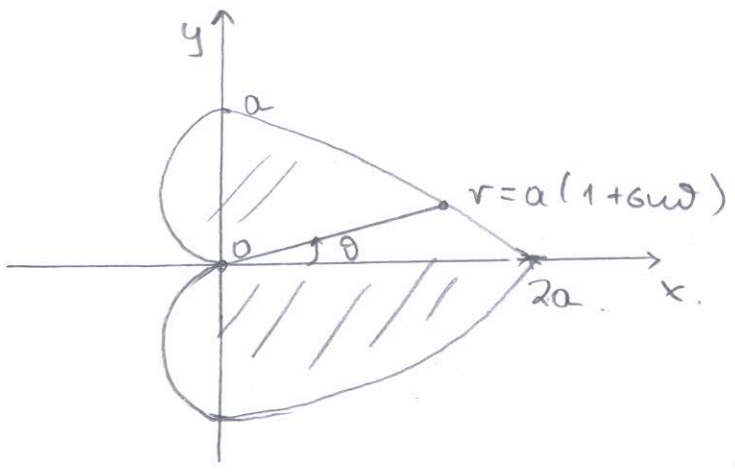

2. $I = \iint_D (1 - x^2 - 4y^2)^{3/2} \, dx \, dy$, όπου $D = \{(x, y) \in \mathbb{R}^2 : x^2 + 4y^2 \leq 1\}$

$(x, y) \begin{pmatrix} 1 & 0 \\ 0 & 4 \end{pmatrix} \begin{pmatrix} x \\ y \end{pmatrix} \leq 1$

Λύση

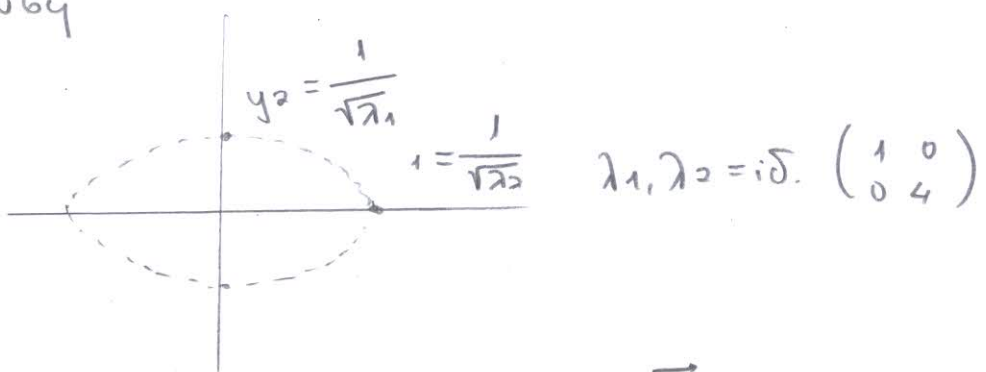

$$\begin{aligned} \vec{T} \quad x &= r \cos \theta \\ 2y &= r \sin \theta \end{aligned} \quad \left| \quad \begin{aligned} x &= r \cos \theta \\ y &= \frac{r}{2} \sin \theta \end{aligned} \right. \quad \det \vec{T}(r, \theta) = \frac{1}{2}$$

$D^* = \{(r, \theta) : 0 \leq \theta \leq 2\pi, 0 \leq r \leq 1\}$

$I = \int_0^{2\pi} \int_0^1 (1 - r^2)^{3/2} \cdot \left(\frac{1}{2} r\right) \, dr \, d\theta = 2\pi \int_0^1 (1 - r^2)^{3/2} \frac{r}{2} \, dr = \dots = \frac{5\pi}{16}$

$$3) I = \iint_D x^2 \sqrt{4x^2 + 9y^2} dx dy, \quad D = \left\{ (x,y) : \frac{x^2}{9} + \frac{y^2}{4} \leq 1 \right\}$$

Λύση

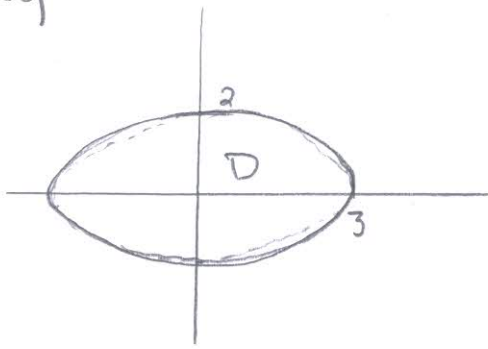
Ιούλιος '07

$$\frac{x}{3} = r \cos \vartheta$$

$$\frac{y}{2} = r \sin \vartheta \quad / \quad \left| \det \frac{\partial(x,y)}{\partial(r,\vartheta)} \right| = 6r$$

$$I = \int_0^{2\pi} \int_0^1 (3r \cos \vartheta)^2 \sqrt{4(3r \cos \vartheta)^2 + 9(2r \sin \vartheta)^2} \cdot 6r dr d\vartheta$$

$$= \int_0^{2\pi} \int_0^1 9r^4 \cos^2 \vartheta \cdot 6 \cdot 6 dr d\vartheta = \int_0^{2\pi} \int_0^1 (36 \cdot 9) r^4 \cos^2 \vartheta dr d\vartheta$$

$$= \frac{324}{5} \pi$$

$$4) I = \iint_D (x^2 + y^2) dx dy \quad D = \left\{ (x,y) : x^2 + y^2 \geq 4, \frac{x^2}{9} + \frac{y^2}{16} \leq 1 \right\}$$

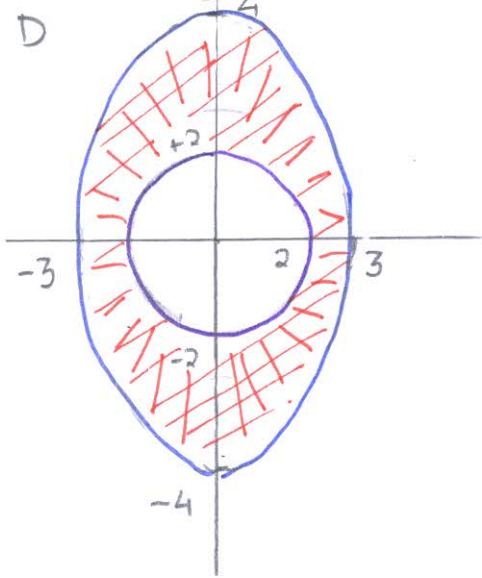

$$D_1 = \left\{ (x,y) : x^2 + y^2 \leq 4 \right\}$$

$$D_1^* = \left\{ (r,\vartheta) : 0 \leq \vartheta \leq 2\pi, 0 \leq r \leq 2 \right\}$$

$$x = r \cos \vartheta, \quad y = r \sin \vartheta$$

$$D_2 = \left\{ (x,y) : \left(\frac{x}{3}\right)^2 + \left(\frac{y}{4}\right)^2 \leq 1 \right\}$$

$$D_2^* = \left\{ (r,\vartheta) : 0 \leq \vartheta \leq 2\pi, 0 \leq r \leq 1 \right\}$$

$$x = 3r \cos \vartheta, \quad y = 4r \sin \vartheta$$

$$I_1 = \int_0^{2\pi} \int_0^2 r^2 \cdot r dr d\vartheta \quad (= 8\pi)$$

$$I_2 = \int_0^{2\pi} \int_0^1 \left((3r \cos \vartheta)^2 + (4r \sin \vartheta)^2 \right) 12r dr d\vartheta$$

$$5) I = \iint_D x \, dx \, dy \quad D = \{(x,y) : (x-1)^2 + y^2 \leq 1, x^2 + (y-1)^2 \leq 1\}$$

Φεβρουάριος '09

Λύση

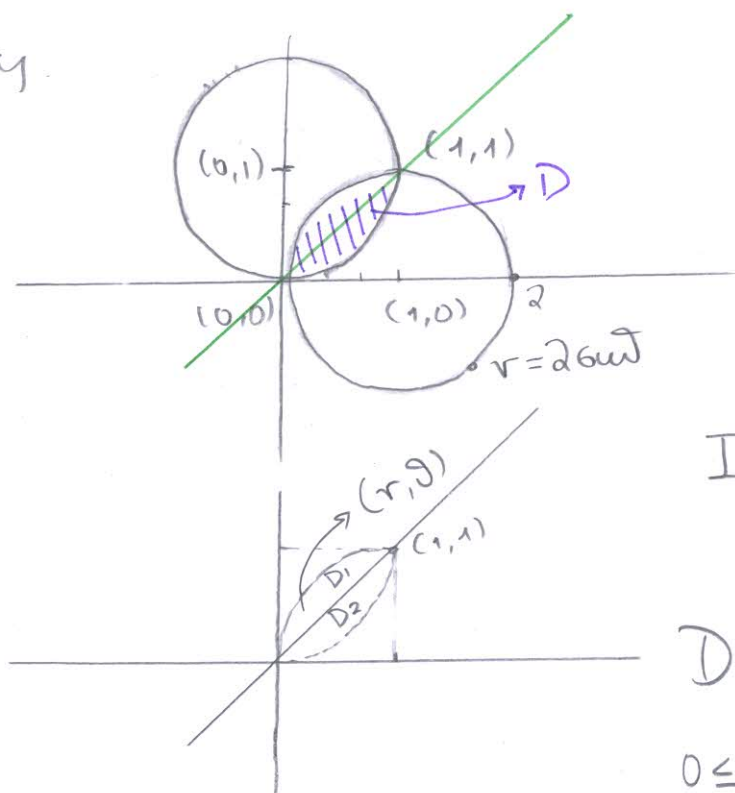

$$\left. \begin{aligned} x^2 + y^2 &\leq 2x \\ x^2 + y^2 &\leq 2y \end{aligned} \right\}$$

$$I = \iint_{D_1} x + \iint_{D_2} x$$

$$D_1: x^2 + y^2 \leq 2x \quad \left\{ \begin{aligned} x &= r \cos \vartheta \\ y &= r \sin \vartheta \end{aligned} \right.$$

$$0 \leq r \leq 2 \cos \vartheta, \quad \frac{\pi}{4} \leq \vartheta \leq \frac{\pi}{2}$$

$$\iint_{D_1} x \, dx \, dy = \int_{\frac{\pi}{4}}^{\frac{\pi}{2}} \int_0^{2 \cos \vartheta} (r \cos \vartheta) \cdot r \, dr \, d\vartheta = \dots = \frac{1}{6}$$

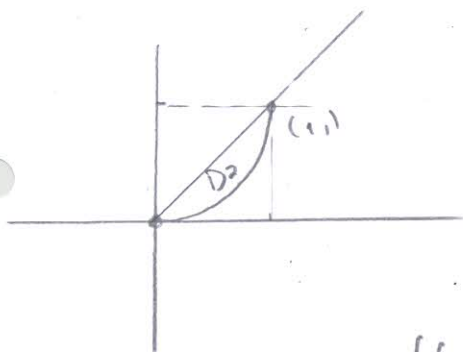

$$D_2: x^2 + y^2 \leq 2y \quad \left\{ \begin{aligned} x &= r \cos \vartheta \\ y &= r \sin \vartheta \end{aligned} \right.$$

$$D_2^*: 0 \leq \vartheta \leq \frac{\pi}{4}, \quad 0 \leq r \leq 2 \sin \vartheta$$

$$\iint_{D_2} x \, dx \, dy = \int_0^{\frac{\pi}{4}} \int_0^{2 \sin \vartheta} (r \cos \vartheta) \cdot r \, dr \, d\vartheta = \frac{1}{6}$$

$$I = \iint_D xy \, dx \, dy$$

$$D = \left\{ (x,y) : (x-2)^2 + y^2 \leq 4, x^2 + (y-2)^2 \leq 4 \right\}$$

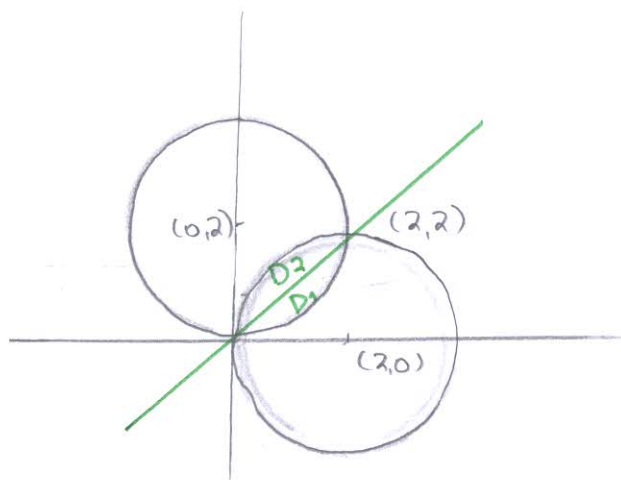

$$f(x,y) = f(y,x)$$

$$D = D_1 \cup D_2 \quad / \quad \text{Sym. } y=x$$

$$\iint_D xy \, dx \, dy = 2 \iint_{D_1} xy \, dx \, dy$$

$$D_1, x^2 + y^2 \leq 4y \quad / \quad 0 \leq r \leq 4 \sin \vartheta$$

$$0 \leq \vartheta \leq \frac{\pi}{4}$$

$$\iint_D xy \, dx \, dy = 2 \int_0^{\pi/4} \left(\int_0^{4 \sin \vartheta} (r^2 \sin \vartheta \cos \vartheta) \cdot r \, dr \right) d\vartheta =$$

$$= 2 \int_0^{\pi/4} \left(\frac{1}{4} (4 \sin \vartheta)^4 \sin \vartheta \cos \vartheta \, d\vartheta \right) = \frac{4^4}{2} \int_0^{\pi/4} \sin^5 \vartheta \cos \vartheta \, d\vartheta =$$

$$= \frac{4^4}{2} \left[\frac{1}{6} \sin^6 \vartheta \right]_{\vartheta=0}^{\pi/4} = \frac{4^4}{12} \left(\frac{1}{\sqrt{2}} \right)^6$$