



## Convexity

Marcel Berger

*The American Mathematical Monthly*, Vol. 97, No. 8, Special Geometry Issue (Oct., 1990), 650-678.

Stable URL:

<http://links.jstor.org/sici?sici=0002-9890%28199010%2997%3A8%3C650%3AC%3E2.0.CO%3B2-B>

*The American Mathematical Monthly* is currently published by Mathematical Association of America.

---

Your use of the JSTOR archive indicates your acceptance of JSTOR's Terms and Conditions of Use, available at <http://www.jstor.org/about/terms.html>. JSTOR's Terms and Conditions of Use provides, in part, that unless you have obtained prior permission, you may not download an entire issue of a journal or multiple copies of articles, and you may use content in the JSTOR archive only for your personal, non-commercial use.

Please contact the publisher regarding any further use of this work. Publisher contact information may be obtained at <http://www.jstor.org/journals/maa.html>.

Each copy of any part of a JSTOR transmission must contain the same copyright notice that appears on the screen or printed page of such transmission.

---

JSTOR is an independent not-for-profit organization dedicated to creating and preserving a digital archive of scholarly journals. For more information regarding JSTOR, please contact [support@jstor.org](mailto:support@jstor.org).

## Convexity

MARCEL BERGER, IHES, *Bures-sur-Yvette, France*

MARCEL BERGER: Born Paris, France, 1927. After Ph.D. on “Holonomy groups of Riemannian manifolds” under A. Lichnerowicz, was professor at the universities of Strasbourg, Nice and Paris 1955–1974. From 1974–1985 Director of Research with the CNRS (Centre National de la Recherche Scientifique). Since 1985, Director of the IHES (Institut des Hautes Etudes Scientifiques). Visited a full year MIT 1956–57 and University of California, Berkeley 1961–62. President of the French Mathematical Society 1979–81. Corresponding member of the French Academy of Sciences since 1982. Rademacher lecturer (Univ. of Pennsylvania) 1981. Editor and managing editor of various mathematical journals, managing editor of the yellow Springer *Grundlehren des Mathematischen Wissenschaften*. Published around 45 papers on Riemannian geometry and three books (all with Springer): *Geometry I and II*, (with Gostiaux) *Differential Geometry: Manifolds, Curves and Surfaces*, and (with Berry, Pansu and St. Raymond) *Problems in Geometry*.

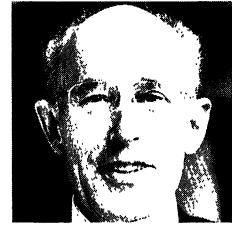

Convexity, as we shall see, is a very old topic which can be traced at very least to Archimedes. It has more or less always been in favor, and now it is making a very strong comeback. This can be attributed in part to the rise of linear programming and the computer era starting from the '60s. But the geometric method in analysis has come up with wonderful results including some spectacular ones on convex bodies.

At the same time, convexity is an extremely simple and natural notion. So we think the reader will readily appreciate what follows. Interesting in itself, it will also illustrate some facts about mathematics, facts that are more or less classical, but always important to realize, paradoxical though they may be. First, questions or problems arise that are very simple to formulate (as in number theory) but to which the answers are either still unknown or have been found only very recently, often using very hard techniques from other parts of mathematics. The second fact is that for elementary geometric problems formulated in our ordinary 2 or 3-dimensional space, one is forced to use abstraction and, among other things, to “go to the infinite” or to higher dimensional spaces. Finally, intuition is sometimes quite misleading.

Because of the restricted length of this article, I cannot be exhaustive. Indeed I had to select only a few topics. Selection was based on naturalness and simplicity, my own taste, and illustration of the facts I have just mentioned. Standard topics which really could not be included receive a passing mention in the last section. The material has been organized as follows.

1. Convexity is a natural notion; historical examples
2. Rigorous definitions; examples
3. The John-Loewner ellipsoid; applications
4. Convex functions; examples and applications
5. Polytopes: four “elementary” problems
6. Two algebraic operations on the set of all convex bodies: duality and addition

7. Topology in the set of all convex bodies: intuition is dangerous
8. A brief look at some topics in convexity

To prepare the present text I received help from, among others, Peter Gruber and Vitali Milman. It is a pleasure for me to thank them here.

### 1. Convexity is a natural notion; historical examples

In art, the words *concave* and *convex* are commonly used, as shown in the following comment on a modern sculpture:

This sculpture reflects the influence of Cubism in its optical juxtaposition of interchangeable *concave and convex forms*, and in its use of a void to express a mass (from *Treasures of the Israel Museum, Jerusalem*, Geneva, 1985).



*Woman Combing Hair* (Bronze)—Alexander Archipenko (1887–1964)  
(Courtesy the Israel Museum, Jerusalem)

The same applies to anatomy textbooks:

Menisci or half-moon fibro-cartilages. *Arranged in this manner, the glenoid cavities do not adapt to the femur condyles. They fit together by means of menisci or half-moon fibro-cartilages placed between the tibia and the femur.*

*Fibro-cartilages, like glenoid cavities, are external or internal. Each is a triangular prismatic blade curved into a crescent.*

*They are seen to possess: a concave upper face, connected with the femur condyles; an underside, in contact with the periphery of the corresponding glenoid cavity; an outer or peripheral face (the base of the prism), which is convex, very thick, adhering to the articular capsule; an inner or central edge, which is concave, trenchant, and whose concavity faces the centre of the glenoid cavity. . . (translation from a classic French book on anatomy by Rouvière).*

Note that convexity and concavity appear to be such commonsense notions that neither is defined in texts on art or anatomy!

Archimedes (circa 250 B.C.) explicitly stated that the inner curve of the figure below is shorter than the outer one, if the inner one is convex. This is obviously false if it is not.



Poinsot (circa 1800) looked into convexity when he studied statics, stating, for example, that to ensure stability for the table below one needs the vertical line through the center of gravity to intersect the supporting plane inside the convex envelope (see section 2) of the set made up by the legs of the table.

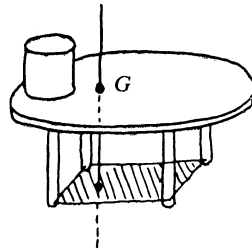

Fourier also studied statics around the same time and was led to study simultaneous linear inequalities like these:

$$\begin{array}{l}
 a'x + b'y + c' \leq 0 \quad ax + by + c \geq 0 \\
 a''x + b''y + c'' \leq 0
 \end{array}$$

useless

He was smart enough to realize the need to determine which ones were really relevant (see section 5). This was the origin of linear programming which began to

develop in the '60s. It consists for example in asking:

Find the maximum of  $y = x_1 - x_2 + 2x_3$  if

$$\begin{cases} x_1 + x_2 + 3x_3 + x_4 \leq 5 \\ x_1 + x_3 - 4x_4 \leq 2 \\ x_1 \geq 0. \end{cases}$$

A large variety of computer programs are available to solve such problems. The remark announced above is that most of the interest in linear programming (through computers) lies in working with very large numbers of inequalities and variables. Hence the need (by no means a mathematician's luxury) to work and develop intuition in high-dimensional spaces.

Back in the 1720s Newton was already using convexity in a basic manner to solve the problem of finding the local shape of a real algebraic plane curve at a singular point, however complicated. His solution was quite complete, as the following example shows:

$$2y^5 + y^4x^3 - 7y^4x^5 + 3y^3x^2 - y^2x^4 - 5y^2x + yx^4 + x^5 = 0.$$

The singularity to be studied is at the origin (0, 0). If this is not the case adjust it by suitable translation of coordinates. Now put a dot at (m, n) in the lattice  $\mathbb{N} \times \mathbb{N}$  of integral points in the plane  $\mathbb{R}^2$  for every  $a_{m,n}x^m y^n$  in the equation defining the curve, for which  $a_{m,n} \neq 0$ :

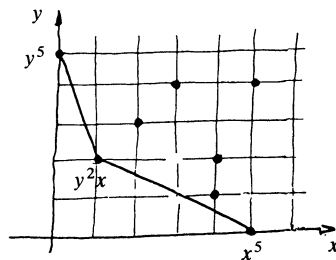

Then draw the convex envelope (paying attention only to the west and south parts) of this set of dots, thereby obtaining a number of segments. For each segment, extract the two terms that correspond to the end points of that segment from the original equation of the curve. Draw each of these two-term curves locally. Newton's theorem is that, whatever the other dots, the union of the preceding curves drawn gives the local shape of the total curve. See [14], [36] for more details and the general theory.

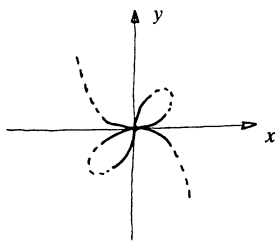

three branches

$$2y^5 - 5y^2x = 0$$

↓

$$2y^3 - 5x = 0$$

↓

$$5x = 2y^3$$

$$x^5 - 5xy^2 = 0$$

↓

$$x^4 - 5y^2 = 0$$

↓

$$x^2 = \sqrt{5}y \text{ and } x^2 = -\sqrt{5}y$$

$$(x^5 - 5xy^2 + 2y^5 = 0)$$

**2. Rigorous definitions; examples**

In chapters 2 to 6 we will work exclusively in the linear space  $\mathbf{R}^d = \{x = (x_1, \dots, x_d): x_i \in \mathbf{R}\}$ . According to the nature of the problem that we will be studying, we consider it as *endowed or not* with its canonical Euclidean metric  $d(x, y) = \sqrt{(x_1 - y_1)^2 + \dots + (x_d - y_d)^2}$ .

A subset  $K$  of  $\mathbf{R}^d$  is said to be *convex* if for every  $x$  and  $y$  in  $K$  the segment  $[x, y]$  of  $\mathbf{R}^d$  whose ends are  $x$  and  $y$  is all contained in  $K: [x, y] \subset K$ . The pictures below show convex and nonconvex sets. Because the open disk  $x^2 + y^2 < 1$ , plus *any* part of its boundary (the circle  $x^2 + y^2 = 1$ ) is convex, we will always work with *open* or *closed* convex sets. Note that things are different for the square. Recall, if need be, that a subset  $K$  of  $\mathbf{R}^d$  is said to be *open* if any of its points  $x$  is the center of an open ball  $B(x, r) = \{y: d(x, y) < r\}$  ( $r > 0$ ) entirely contained in  $K$ . It is said to be *closed* if its *complement*  $\mathbf{R}^d \setminus K$  is open. It is equivalent to say that the limit  $x$  of every convergent sequence  $\{x_i\}$  is still in  $K$ .

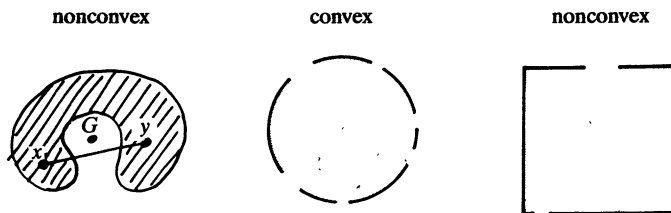

Three immediate properties of convex sets are the following:

The first was already known to Archimedes: if  $K$  is a plate in  $\mathbf{R}^2$  or a body in  $\mathbf{R}^3$ , of some material, then it contains its center of mass (center of gravity). Note that constant density is not required.

The second property: look at the two following metrics on a subset  $K$  of  $\mathbf{R}^d$ . The first,  $d_{\mathbf{R}}$  is the so-called *induced* one (from the Euclidean structure of  $\mathbf{R}^d$ )  $d_{\mathbf{R}^d}(x, y) = d(x, y)$  for any  $x, y \in K$  and the Euclidean metric  $d$  on  $\mathbf{R}^d$ . The second, called *intrinsic*, denoted by  $d_K$ , is defined as the infimum  $d_K(x, y)$  of the length in  $\mathbf{R}^d$  of all curves from  $x$  to  $y$  which lie entirely within  $K$ . Then it is easy to see that  $K$  is convex if and only if  $d_K$  is identical with  $d_{\mathbf{R}}$ .

The third property belongs to the realm of algebraic topology, which studies the properties of objects that depend only on maps preserving the topology, in particular those properties that are invariant by continuous deformation. The fact is that all open convex sets are equivalent, in particular equivalent to  $\mathbf{R}^d$  itself. So for an algebraic topologist convex sets are of no interest. The proof is simple: build a continuous map  $K \rightarrow \mathbf{R}^d$  by picking any  $x \in K$  and stretching any non-infinite ray from  $x$  in  $K$  to the infinite associated ray in  $\mathbf{R}^d$ .

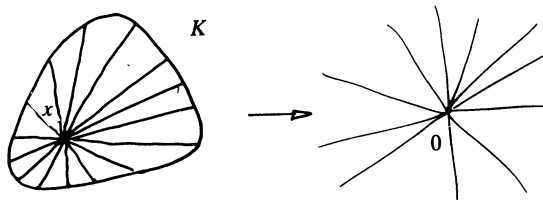

The following explicit examples of convex sets are basic:

(i) Each of the two half-spaces (open or closed) defined by an affine hyperplane (namely the set given by an equation like

$$\sum_{i=1}^d a_i x_i = b,$$

where the  $a_i$ 's are not all 0) is convex. Half-spaces are the building blocks of convexity, since it is classical and not hard to prove that every closed convex set is the intersection of the closed half-spaces which contain it (see section 6). Moreover one can always achieve it with a denumerable family.



(ii) The full (closed) *ellipsoids*

$$\sum_{i=1}^d \frac{x_i^2}{a_i^2} \leq 1.$$

It is very important to remark that—when no Euclidean structure is imposed on  $\mathbf{R}^d$ —all ellipsoids are equivalent (affinely). They are equivalent, in particular, to the standard closed ball  $\sum_{i=1}^d x_i^2 \leq 1$ .



(iii) A closed *parallelepiped* is a set which can be written (after translation) as  $\{(x_1, \dots, x_d): |x_i| \leq 1 \forall i = 1, \dots, d\}$  in a suitable basis of  $\mathbf{R}^d$ . They are all equivalent—affinely—to the standard *cube*  $|x_i| \leq 1$  ( $i = 1, \dots, d$ ) (the coordinates are the standard ones of  $\mathbf{R}^d$ ). But as soon as metric considerations are imposed, then parallelepipeds can be very different.

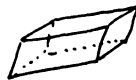

(iv) Any intersection (not even necessarily countable) of convex sets is convex. Hence, it makes sense to speak of the smallest convex set containing a given set  $A \subset \mathbf{R}^d$  and to call it the *convex hull* of  $A$ . It will be denoted by  $\text{conv}(A)$  in the sequel. *Polytopes* are the convex hulls of *finite* sets. Note that not all points are necessary; the really necessary ones are called the *vertices*, or extreme points, of the polytope.

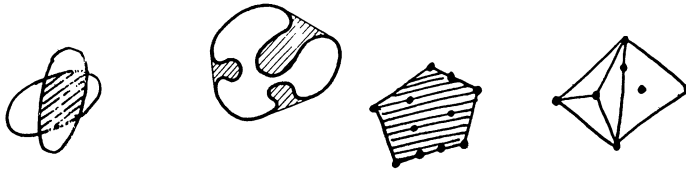

(v) The sets  $|x|^\lambda + |y|^\lambda \leq 1$  in  $\mathbf{R}^2$  are convex for every real number  $\lambda \geq 1$ . The proof is not obvious, but see section 4.

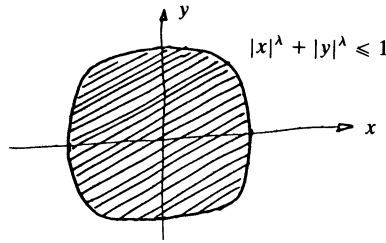

### 3. The John-Loewner ellipsoid; applications

We present here a result that is both simple—though nontrivial—and extremely powerful. It was found independently by F. John (studying mechanics) and C. Loewner (studying complex variable maps), both in the '40s. (The case of  $d = 2$  goes back to Behrend in the '30s.) It says that given any bounded set  $A$  (with nonvoid interior) in  $\mathbf{R}^d$ , there exists one and *only* one ellipsoid  $E$  of minimal volume containing  $A$  (recall that ellipsoids are centered at the origin).

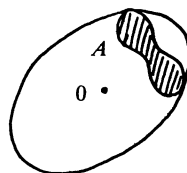

The volume of an ellipsoid  $\sum_{i=1}^d (x_i^2/a_i^2) \leq 1$  is to be understood in the elementary sense, namely as the canonical measure on  $\mathbf{R}^d$  (with the Euclidean standard metric). It is given by

$$\text{Vol} \left( \sum_{i=1}^d \frac{x_i^2}{a_i^2} \leq 1 \right) = \left( \prod_{i=1}^d a_i \right) \cdot \text{Vol} \left( \sum_{i=1}^d x_i^2 \leq 1 \right).$$

This will follow for example from the determinant change of variable rule in integration theory. We denote by  $\beta(d)$  the volume of the standard ball  $\sum_{i=1}^d x_i^2 \leq 1$ . The value of this important function can be found in some calculus books (see [6])



namely

$$\beta(d = 2k) = \frac{\pi^k}{k!}$$

$$\beta(d = 2k + 1) = \frac{2^{k+1}\pi^k}{1 \cdot 3 \cdot 5 \cdots = (2k + 1)}$$

or in one shot

$$\beta(d) = \frac{\pi^{d/2}}{\Gamma\left(\frac{d}{2} + 1\right)}$$

if you know the  $\Gamma$ -function.

If you have never thought about it, study the behavior of  $\beta(d)$  as  $d$  increases. Compute in particular the first value of  $d$  for which  $\beta(d) < 1$  (the volume of the cube of side equal to 1). An asymptotic evaluation of  $\beta(d)$  is important (see section 6). From Stirling's formula one gets

$$\beta(d) \sim \text{constant} \cdot \left(\frac{2\pi e}{d}\right)^{(d+2)/2} \text{ as } d \rightarrow \infty.$$

It also permits one to compare  $\beta(d)$  with the volume, equal to  $2^d$ , of the cube circumscribed by the unit ball. See an interesting application at the end of section 5.A.

Let us come back to the John-Loewner assertion. Existence is an easy compactness argument. Just be careful to avoid the degeneracy of ellipsoids. This is guaranteed precisely by the non-void interior condition. To prove uniqueness argue by contradiction. Show that, given two distinct ellipsoids of the same volume, there exists a third one of smaller volume which contains their intersection. Simplify the computation by using the reduction of positive quadratic forms to simultaneous diagonal forms. Another proof is given in the next section.

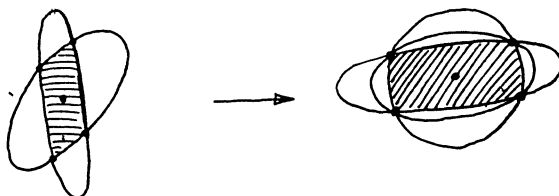

The John-Loewner ellipsoid is widely used nowadays in the study of convex sets, for both pure and applied mathematics, see [19]. For our purpose let us mention three applications to various fields.

The first application is to the theory of quadrics (conics for the plane). An ellipsoid  $E$  has the property (called diametrical) of admitting an affine hyperplane symmetry for any direction  $\delta$  of lines in  $\mathbf{R}^d$ . That is to say there exists a hyperplane  $H_\delta$  associated to  $\delta$  such that the hyperplane symmetry defined by the pair  $(\delta, H_\delta)$  leaves  $E$  invariant. Are the ellipsoids the only subsets  $A$  of  $\mathbf{R}^d$  enjoying this property for any direction of line? The answer is easily seen to be yes if we use the

John-Loewner ellipsoid  $E$  of the set  $A$ . A bare-handed proof—you should try it—is already extremely involved (and not very enlightening) when  $d = 2$ . For  $d = 3$ , it was done by Bertrand and by Brunn.

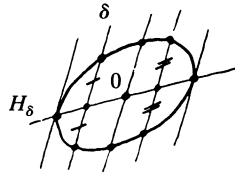

The second application is in geometric-group theory: it states that every compact subgroup  $G$  of the full linear group  $GL(d; \mathbf{R})$  of  $\mathbf{R}^d$  leaves invariant some Euclidean structure on  $\mathbf{R}^d$ . Take any point  $x \neq 0$  in  $\mathbf{R}^d$  and introduce the John ellipsoid of its orbit  $G(x)$ . This ellipsoid yields the desired quadratic form; the uniqueness is of course basic. Note more generally that the compact group we are studying can be taken in the full group  $Aff(d; \mathbf{R})$  of all affine transformations of  $\mathbf{R}^d$  (we permit translations). For by the Archimedes result of our introduction, the center of mass of the orbit  $G(x)$  is invariant under  $G$  so we can take it to be the origin  $0$ . Properly rephrased, the above existence result is group theoretical: two maximal compact subgroups  $G, G'$  of  $GL(d; \mathbf{R})$  are necessarily conjugate, i.e., there exists  $g$  in  $GL(d; \mathbf{R})$  such that  $G' = gGg^{-1}$ . This is actually a special case of a general result of Elie Cartan to the effect that this conjugacy of compact maximal subgroups is valid in any Lie group.

The third application is in fact what F. John had in mind. Call a convex body a non-void-interior compact set of  $\mathbf{R}^d$ . Then for every convex body  $K$  of  $\mathbf{R}^d$  which is symmetric around the origin ( $\forall x \in K$  then  $-x \in K$ ) there exists an ellipsoid  $E$  such that  $E \subset K \subset \lambda K$  and  $\lambda \leq \sqrt{d}$ . The bound is clearly optimal as shown by the cube.



Again the proof works by contradiction. Using duality (see section 6 if necessary) introduce the ellipsoid of maximal volume contained in  $K$  and think of it (after a suitable linear transformation—remember (ii) in section 2) as the unit sphere in  $\mathbf{R}^d$ .

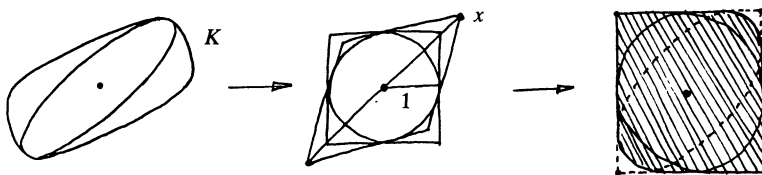

Assume there exists an  $x \in K$  with  $\|x\| > \sqrt{2}$ . By the symmetry assumption  $K$  will contain the domain shaded above. Elementary calculus (again use a reduction to the standard cube) shows that the sphere inscribed in that cube is contained in  $K$  and has a larger volume than that of any inscribed ellipsoid.

It is worth mentioning the  $\sqrt{d}$ -squeezing property for two reasons.

The first is the *Banach-Mazur metric structure* on the set of all symmetric convex bodies in  $\mathbf{R}^d$  which is defined as follows: for two convex bodies  $K, H$  (symmetric in the origin) call  $\lambda$  the smallest number for which there exists a linear transformation  $f$  of  $\mathbf{R}^d$  such that  $f(H) \subset K \subset f(\lambda H)$ . Then  $d(K, H) = \lambda$  is called the Banach-Mazur distance (it is in fact a so-called multiplicative distance and strictly speaking after dividing the set of convex bodies by the set of linear isomorphisms). John’s result is now simply that the distance between any symmetric convex body and the unit ball is always  $\leq \log \sqrt{d}$ . It says that a Banach space structure on  $\mathbf{R}^d$  is never too far from a Euclidean structure!

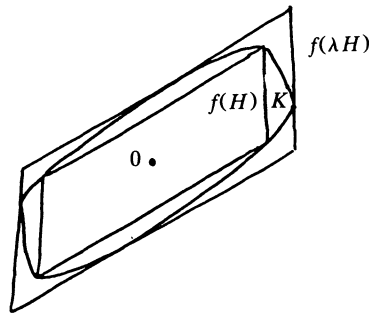

The second reason has to do with the very simple question: what is the greatest Banach-Mazur distance to the unit cube? This is a case (see the introduction) where the answer is not known today. The aim is to squeeze a symmetric convex body between two homothetic parallelepipeds as close together as possible. The value  $\sqrt{d}$  is wrong. Szarek proved in 1987 that one needs at least  $\sqrt{d} \log d$ . The optimal bounds are still unknown. Two more comments. First, Szarek’s construction of examples is not really explicit but based on probability theory. This technique is now widely used in convexity theory. The idea is that for a “general” convex body  $K$  the points of contact of  $K$  with the optimal cube are far from an orthonormal basis. On the contrary the angles are quite small. Second—a very general remark—for practical applications to theoretical harmonic analysis or to numerical analysis, it is more important to have asymptotic estimation when the dimension  $d$  goes to infinity than explicit values. In that direction, Szarek and Talagrand proved in 1988 that asymptotically the Banach-Mazur distance between the cube and any symmetric convex body is always of the order of  $d^{7/8}$ . The conjectured order is  $\sqrt{d} \log d$  (up to some universal constant). See [33].

**4. Convex functions; examples and applications**

The simplest notion to start with is that of a convex real valued function defined on an interval—say closed  $[a, b]$ —of the real line:

$$f: [a, b] \rightarrow \mathbf{R} \text{ is said to be convex (resp. strictly convex) if:}$$

$$f(\lambda x + (1 - \lambda)y) \leq \lambda f(x) + (1 - \lambda)f(y) \text{ (resp., } < \text{)}$$

$$\forall a \leq x < y \leq b, \quad 0 < \lambda < 1.$$

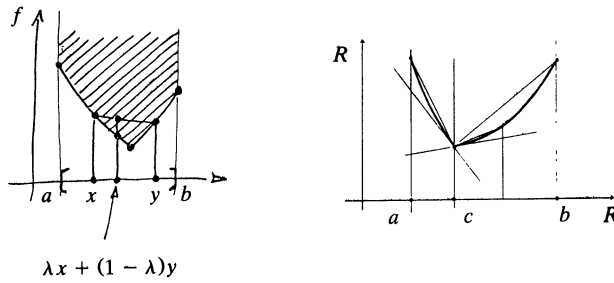

Otherwise stated: the graph of  $f$  is always below the chord segment joining every pair of its points. More simply:  $f$  convex is equivalent to requiring that the *epigraph* of  $f$  (namely the set  $\{(x, y): x \in [a, b], y \geq f(x)\} \subset \mathbf{R}^2$ ) is convex. A trivial induction yields

$$f\left(\sum_{i=1}^n \lambda_i x_i\right) \leq \sum_{i=1}^n \lambda_i f(x_i) \quad \forall n \quad \forall x_i \in [a, b] \quad \forall \lambda_i \geq 0 \quad \text{with} \quad \sum_{i=1}^n \lambda_i = 1.$$

Convex functions are necessarily quite regular: they everywhere admit a right and a left derivative which need not coincide, though the set at which they do not coincide can be at most countable. In particular they are almost everywhere (i.e., up to a set of measure 0) differentiable, in fact continuously differentiable. They also admit almost everywhere a second derivative  $f'' \geq 0$ . Most important is the converse: if  $f''$  exists and is non-negative (resp., positive) everywhere then  $f$  is convex (resp. strictly convex). This easy result is tremendously powerful. Two standard and basic examples are

(i)  $f(x) = -\log x$  on  $[1, \infty[$  yields the inequality

$$\sum_{i=1}^n \lambda_i a_i \geq \prod_{i=1}^n a_i^{\lambda_i} \quad \left(\lambda_i \geq 0, \sum_{i=1}^n \lambda_i = 1\right)$$

in particular

$$a_1 \cdots a_n \leq \left(\frac{a_1 + \cdots + a_n}{n}\right)^n.$$

This is easy for  $n = 2$ , but from  $n = 3$  on it is not so obvious.

(ii)  $f(x) = x^p, p \geq 1$ . After tricky (but not deep) manipulations, one gets the

Hölder inequality:

$$\sum_i x_i y_i \leq \left(\sum_i x_i^p\right)^{1/p} \left(\sum_i y_i^q\right)^{1/q} \quad \text{with} \quad \frac{1}{p} + \frac{1}{q} = 1$$

and the Minkowski inequality:

$$\left(\sum_i |x_i + y_i|^p\right)^{1/p} \leq \left(\sum_i |x_i|^p\right)^{1/p} + \left(\sum_i |y_i|^p\right)^{1/p}.$$

The latter says that the set  $|x|^\lambda + |y|^\lambda \leq 1$  is convex in  $\mathbf{R}^2$ . This is not obvious, even for  $\lambda = 4$ .

The notion of convexity can be extended to numerical functions defined on a subset  $K$  of  $\mathbf{R}^d$ :

$$f(lx + (1 - l)y) \leq lf(x) + (1 - l)f(y)$$

so that an obvious necessary condition for this condition to make sense is that  $K$  should be a convex subset of  $\mathbf{R}^d$ . General convex functions are also quite regular.

They always admit a differential almost everywhere, in fact they are almost everywhere of class  $C^1$ . More: almost everywhere of class  $C^2$ , i.e., they admit a second differential  $f''(x): \mathbf{R}^d \times \mathbf{R}^d \rightarrow \mathbf{R}$  which is there a positive quadratic form. The converse—analogue to the interval case—is also true.

Convex functions have two basic properties, widely used in theoretical and applied mathematics. Their maximum is attained only at the boundary of their domain of definition. A strictly convex function admits at most one minimum. John-Loewner ellipsoid uniqueness might also be proved using the latter property. Identify ellipsoids in  $\mathbf{R}^d$  with quadratic forms (positive definite) and consider the set of all of them whose seat is in  $\mathbf{R}^{d(d+1)/2}$ . This is done, for example, with the map

$$\sum_{i,j} a_{ij} x_i x_j \rightarrow \left( (a_{ij}) \right) \in \mathbf{R}^{d(d+1)/2},$$

$$\parallel$$

$$a_{ji}$$

It is typical of how mathematicians build up successive levels of abstraction. The volume  $\text{Vol}(E(q))$  of the ellipsoid associated with  $q$  is equal to  $\det(q)^{-1/2} \cdot \beta(d)$ , where  $\det$  stands for determinant. Then check that the function  $q \rightarrow \det(q)^{-1/2}$  is strictly convex.

We will give ample consideration to the regularity of convex functions in section 7. A basic example is given in sections 5 and 6, the Brunn-Minkowski inequality.

### 5. Polytopes: Four “elementary” problems

Recall that a *polytope* is the convex hull of finite points in some  $\mathbf{R}^d$ ; if  $d = 2$  we call it a polygon (convex), and if  $d = 3$  a polyhedron (convex). Its *vertices* are the really necessary points; any that are not useful should be thrown out. It is not hard to see (in section 6, for example) that a polytope is also a finite intersection of half-spaces. Conversely, one should add compactness. The *faces* ( $(d - 1)$ -dimensional faces, to be exact) are the intersections of the polytope with the *really necessary* hyperplanes which define it. Such a face is a polytope in its hyperplane.

By induction one defines the  *$i$ -faces* of a polytope ( $i = 0, 1, \dots, d - 1$ ). The  $(d - 1)$ -faces are the faces, the 0-faces are the vertices, the 1-faces are the *edges*. In dimension 3 this exhausts them.

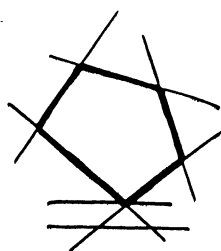
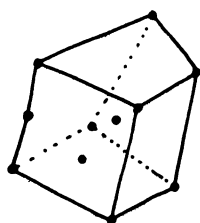

“the most popular polyhedron”

Examples of polytopes are parallelepipeds. The simplest are the simplices. A *simplex* is a polytope generated by the minimum number of points in  $\mathbf{R}^d$  for it to be a convex body (in particular not contained in some hyperplane). This number is  $d + 1$ . All simplices are affinely the same. Thus, not surprisingly, simplices are of basic utility (e.g., the simplex method of Dantzig in linear analysis).

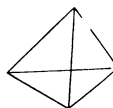
 $d = 2$ : triangle $d = 3$ : tetrahedron

Because of their simple definition and the everyday look they have about them, it is natural to expect that:

- a) everything about polytopes has been known for a long time
- b) everything about polytopes is easy to prove.

In the light of our introduction, the reader will already have guessed that both statements are false. We will illustrate this with four topics.

#### A. Hyperplane sections of the cube

Consider the unit cube  $C = [-\frac{1}{2}, \frac{1}{2}]^d$  in  $\mathbf{R}^d$  and cut it by hyperplanes. Which hyperplane cuts  $C$  with maximum volume ( $(d - 1)$ -dimensional measure, that is to say its volume for standard measure in the hyperplane where it stands, for the natural Euclidean structure)?

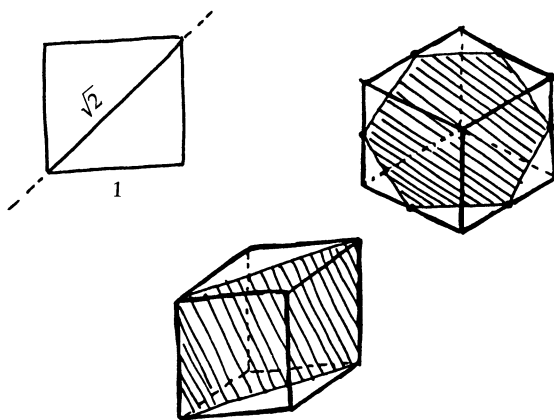

For  $d = 2$  the answer is  $\sqrt{2}$ , attained by either of the two diagonals. For  $d = 3$  the smart reader will guess that the most wonderful section of the cube is the regular hexagon obtained by cutting it through the origin by a hyperplane orthogonal to a diagonal. But he will be wrong because its area is equal to  $3\sqrt{3}/4$ , whereas the section through two opposite diagonals of parallel faces has area  $\sqrt{2} > 3\sqrt{3}/4$ . It was conjectured for quite a while that  $\sqrt{2}$  is the optimum (clearly attained) for any  $d$ . This was proved by K. Ball only in 1986, see [2]. The proof is by no means elementary. It is based on probability theory and, at the root of it lies the Fourier

transform, applied twice to get estimates of the volume of sections by hyperplanes. One then gets the following beautiful formula for the section of  $C$  by the hyperplane  $H$  given by the equation  $\sum_{i=1}^d a_i x_i = 0$  ( $\sum_{i=1}^d a_i^2 = 1$ ):

$$\text{volume}(C \cap H) = \frac{1}{\pi} \int_{-\infty}^{\infty} \frac{\sin a_1 t}{a_1 t} \cdots \frac{\sin a_d t}{a_d t} \cdot dt.$$

Then one finishes the proof with Hölder inequality (under the integral form of the finite form given in section 4) and the fact that

$$\frac{1}{\pi} \int_{-\infty}^{\infty} \left| \frac{\sin t}{t} \right|^p dt \leq \frac{\sqrt{2}}{\sqrt{p}} \quad \text{if } p \geq 2$$

and equality only if  $p = 2$ . This latter inequality is quite subtle to prove.

An interesting consequence of Ball's result is the very easy disproof of a (quite intuitive) conjecture of Herbert Busemann: if two convex bodies  $K$  and  $H$  (say symmetric in the origin) are such that the volume of the section of  $K$  by any hyperplane  $P$  through the origin is always smaller than the volume of the section of  $H$  by  $P$ , then the volume of  $K$  is smaller than the volume of  $H$ . This is trivially true when  $d = 2$ ; it is open for  $d = 3, \dots, 7$ . A quite involved counterexample was given by Larman and Rogers in 1975 for  $d = 12$ . But from Ball's result it follows immediately that the conjecture is false for any  $d \geq 10$  when  $K$  is the unit cube in  $\mathbf{R}^d$  and  $H$  the sphere in  $\mathbf{R}^d$  of radius so adjusted that its volume is equal to one.

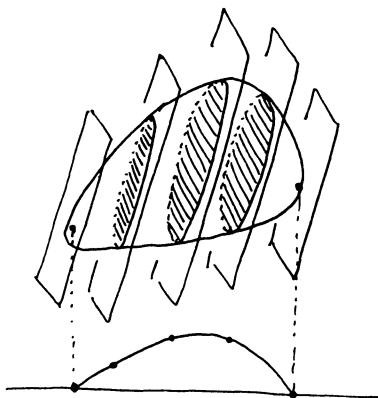

Here is a small remark in the same spirit. Cut any symmetric convex body by parallel hyperplanes. You expect the volumes of these sections to be a monotone function, starting at a minimum when the hyperplane just touches the body and reaching a maximum through the origin. This is easy to prove with the Brunn-Minkowski inequality (see section 6), but however obvious it may seem, no elementary proof is known. Further: the Brunn-Minkowski inequality is equivalent to the fact that the  $1/(d-1)$  power of the volume of the parallel hyperplane sections of any convex body (symmetric or not) in  $\mathbf{R}^d$  is a *concave* function. It is only in dimension two that this is completely elementary.

Note also that, although apparently obvious, it is not easy to prove that any hyperplane section through the center of a unit cube has a volume greater than or equal to one. It was proven by Vaaler only in 1979!

## B. Combinatorics

Let us denote by  $f_i$  the number of the  $i$ -dimensional faces of a polytope  $\Gamma$  of  $\mathbf{R}^d$ . Here  $i$  runs from 0 to  $d - 1$ . Are there necessary (and sufficient) conditions for a given sequence  $(f_0, f_1, \dots, f_{d-1})$  of integers to be that of some polytope in  $\mathbf{R}^d$ ? The case  $d = 2$  is trivial:  $f_0 = f_1$  is both necessary and sufficient. When  $d = 3$  Euler found in 1750 the famous necessary condition  $f_0 - f_1 + f_2 = 2$  (which seems also to have been found—though none too explicitly—by Descartes). It is not hard to extend this relation to any  $d$  in the form  $f_0 - f_1 + \dots + (-1)^{d-1}f_{d-1} = (-1)^d$ .

It was only in the 1920's that Steinitz found the set of necessary and sufficient conditions when  $d = 3$ . It reads:

$$f_0 - f_1 + f_2 = 2 \quad \text{and} \quad 4 < f_0 < 2f_2 - 4 \leq 4f_0 - 12.$$

The inequalities were known to Descartes and Euler as necessary ones. For  $d \geq 4$  such a set is unknown. But in the 1980's two basic results were obtained. They concern generic polytopes, namely the so-called *simplicial polytopes*. These are polytopes (in  $\mathbf{R}^d$ ) all of whose  $(d - 1)$ -faces are  $((d - 1) - 1)$  simplices. Equivalently, their vertices are in general position, that is to say that there are never more than  $d$  of them belonging to the one affine hyperplane. They are completely *flexible* in the sense that every vertex can be moved a little bit when all the others are kept fixed.

For simplicial polytopes a necessary and sufficient set of conditions is known, though only since 1980. It is quite complicated. The set of conjectured necessary and sufficient conditions was discovered by McMullen. The way the proofs go is most interesting. The sufficiency—due to Billera and Lee—is obtained by exhibiting the desired polytope from the very involved commutative algebra construction of a Cohen-Macaulay ring. The proof of the necessity, due to Stanley, is even more surprising. It is obtained (following an initial idea of Demazure) by associating with a convex polytope a complex projective algebraic variety and applying to it the so-called “hard Lefschetz theorem.” This story again illustrates the need to use complex number geometry even in order to solve real number problems. See [29], [32].

## C. Can you move a polytope? Can you put it into a computer?

Consider a polyhedron in  $\mathbf{R}^3$  and try to move (slightly) its vertices under the condition that the polyhedron remains of the same combinatorial type, i.e. it keeps the same number of faces, each face keeping the same number of vertices. More algebraically, during the move you want to respect the linear relation which exists between the vertices of the initial polytope. Of course you discard the trivial solutions such as an affine linear transformation of the whole space. The end of the last section shows that, for a *simplicial* polyhedron (i.e., one of which all the faces are triangles) the movability is maximum, every vertex can be moved (slightly) independently of the others. The problem begins to be interesting when one has faces with four or more vertices. In the figures below it will be seen that you cannot move only one vertex, like  $a$ , because this will force new faces into existence. For the dodecahedron, one way is to move the plane of a face slightly. But this is possible only because a dodecahedron is *cosimplicial* (see section 7), that is that when considered as intersection of half-spaces, only three planes meet at one vertex. But this trick does not work for polyhedron No. 3. It can be done by



turning the plane of the face  $abcd$  around  $a$  and  $c$ . Then the general situation seems a very complicated problem for a general polyhedron. In 1920 Steinitz proved a more general theorem about the general polyhedron, to the effect that some graphs can always be realized in  $\mathbf{R}^3$  by a convex polyhedron. As a corollary, any convex polyhedron has sufficient freedom of movement to be approximated as well as required by a polyhedron all of whose vertices have rational number coordinates (call it a *rational polyhedron*).

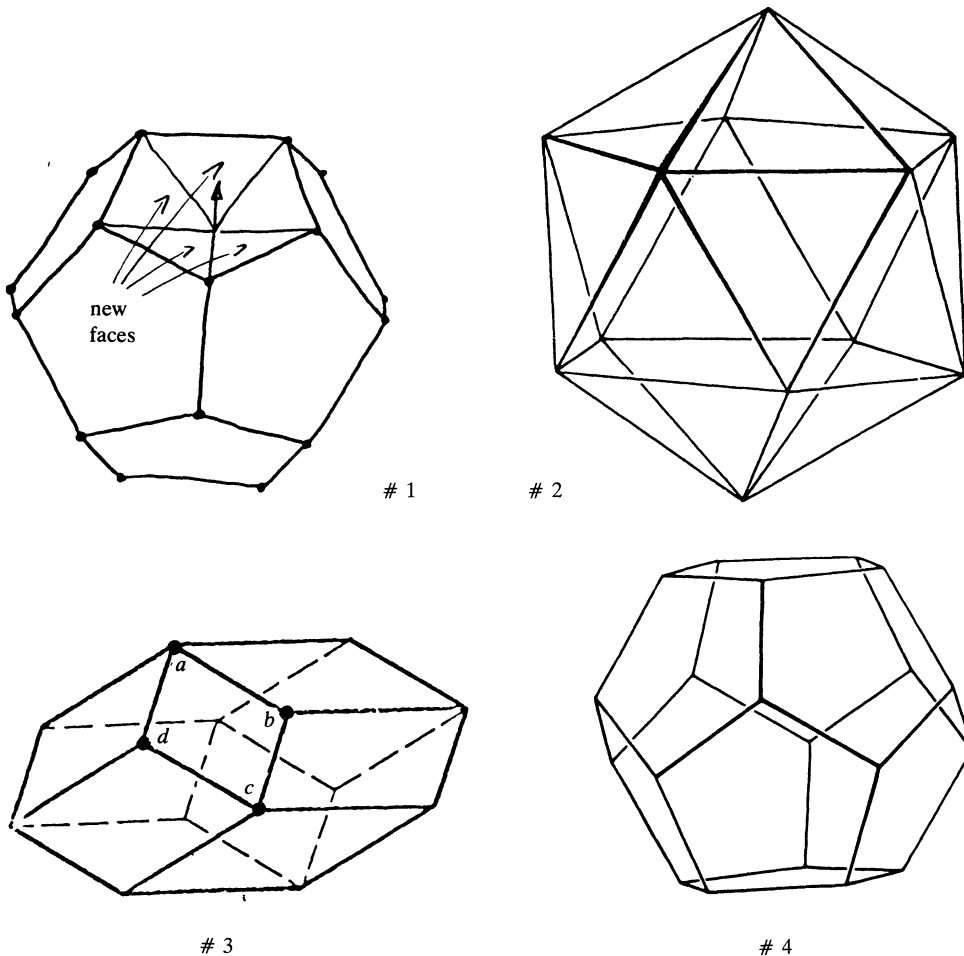

This is important because, once a coordinate system is fixed, a computer can recognize only rational polyhedrons when they are entered by giving the three coordinates of the vertices. This means that, for example, the affine linear relations between vertices have to be truly respected, not only approximated. To end with dimension 3, let us mention that we still do not know how to compute the effective degree of freedom when the combinatorial type is given.

How about higher dimensions? The situation here is dramatically different because in 1967 Perles found a polytope in  $\mathbf{R}^8$  with twelve vertices which cannot be approximated by a rational one. The idea is roughly as follows. The arrangement

of faces will force, in the diagram below,

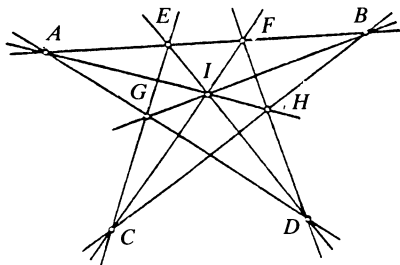

the dotted points to be on lines as indicated. Now an elementary computation in the projective plane (using, if you know it, the notion of cross-ratio) shows that whatever the Euclidean metric is, we should have

$$\frac{EA}{EB} \cdot \frac{FB}{FA} \text{ equal to } \frac{3 - \sqrt{5}}{2} \text{ or } \frac{3 + \sqrt{5}}{2}.$$

But neither of these numbers is rational! See [22].

In 1987 Sturmfels found a polytope in  $\mathbf{R}^6$  with the non-rational approximation property. Whether this can be done in  $\mathbf{R}^5$  or even  $\mathbf{R}^4$  is still an open question. The above shows, in particular, that you cannot implement in a computer every diagram exactly respecting the alignments. For the aficionados, a computer expert will tell you that there are other “theoretical” ways to enter such a diagram into a computer.

A comment on *rigidity* is in order. For the above, the movability was combinatorial, not metric. It was permitted to change the lengths of the edges (and the congruence of the faces). If, moreover, we insist, when moving a polyhedron in  $\mathbf{R}^3$ , that all the faces remain *equal* polygons (this is automatically true if all faces are triangles and if the edges are kept at fixed lengths) then Cauchy proved rigidity back in 1812, namely that only a global Euclidean displacement can achieve it. In fact there was a small gap in Cauchy’s proof that Hadamard and Steinitz filled in independently. Note that it is false for plane polygons as soon as they have at least four vertices.

With a little bit of spherical geometry and induction on dimension, Cauchy’s theorem implies rigidity in any dimension larger than three. Cauchy’s proof is very subtle. See, for example [6].

#### D. Fillers

Call a polygon  $P$  a *filler* of the *Euclidean* plane  $\mathbf{R}^2$  if the whole plane can be filled up (“tiled”) with congruent (equal) copies of  $P$ ; the copies should moreover meet edge to edge.

We first want to find the shape of all possible fillers. Any triangle and any quadrilateral will do. Then there are examples with pentagons and hexagons. The hexagonal case is completely understood, the pentagonal one not yet ([24]). Geometers (in fact crystallographers) have known since the end of the 19th century that no *convex*  $k$ -gon with  $k \geq 7$  can be a filler. Convexity is of course required. It would seem that there is no completely elementary proof. The known proofs use

not only Euler's formula but also a "going to infinity" argument. For fillers of the plane see Thurston's text in the present issue, and the basic reference [24].

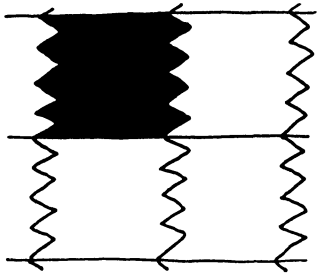

no limit on the number of edges!



for triangles use symmetries

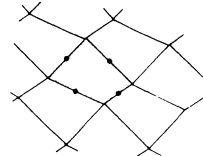
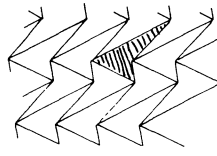

same for quadrilaterals

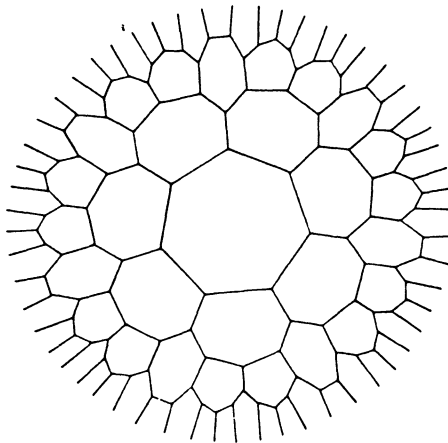
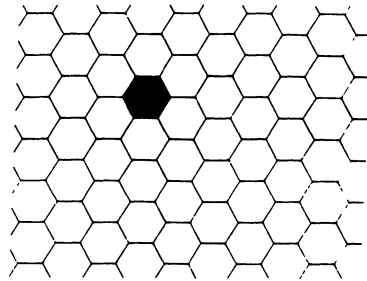
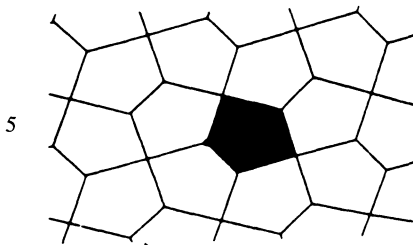
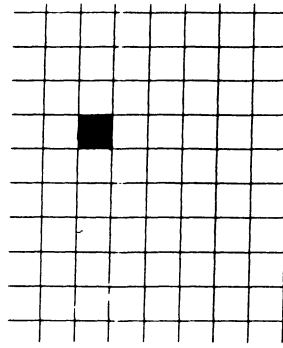
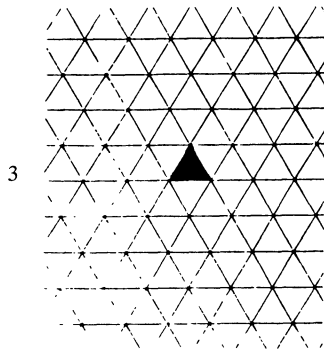

7 but not congruent tiles

We now look at  $\mathbf{R}^3$ . Call a *filler* a polytope  $P$  such that the whole space  $\mathbf{R}^3$  can be filled with congruent copies of  $P$ , still matching face to face.

Here two surprises await us. The first is that there do exist extremely complicated fillers. Engel found one in 1980 with 38 faces and 70 vertices. Some faces are extremely small. This is surprising at first: any filler is surrounded by 38 others and some of the contacts are very tiny. The construction used a computer because of these small faces. It is based on the classical and important notion of what is known as the Dirichlet-Voronoi domains. We start with a lattice  $\Lambda$  in  $\mathbf{R}^3$  and define  $P$  by  $P = \{x \in \mathbf{R}^3: \forall \lambda \in \Lambda: d(x, 0) \leq d(x, \lambda)\}$ . Then, by the very construction, the polytopes  $\{P + \lambda: \lambda \in \Lambda\}$  fill  $\mathbf{R}^3$ . Now Engel's example is obtained by extending the Dirichlet-Voronoi technique as follows. We consider discrete groups  $G$  of isometries of  $\mathbf{R}^3$  which contain a lattice of translations, but in fact  $G$  can also contain rotations and be much bigger than only a lattice group. Then the Engel filler  $P$  is of the type

$$P = \{x \in \mathbf{R}^3: \forall g \in G: d(x, 0) \leq d(x, g(0))\}.$$

This  $P$  is in general called the *fundamental domain* of the group  $G$ .

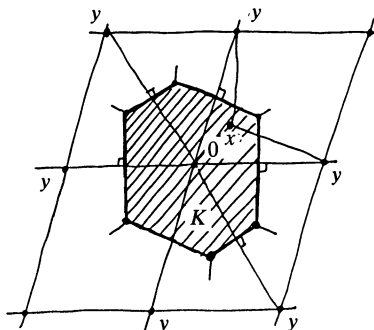

But there is another surprise: there is no known bound for the number of vertices or faces of an  $\mathbf{R}^3$  filler when it is not obtained by a discrete group of isometries techniques. We do not even know that it is bounded! See [23].

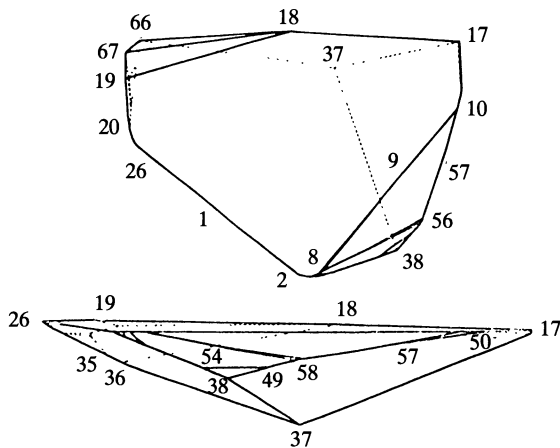

Two views of a 38-faced polytope with 70 vertices, discovered by Engel (1980)

## 6. Two algebraic operations on the set of all convex bodies: Duality and addition

The typical evolution of mathematical understanding consists in reaching higher and higher levels of abstraction, by the building of structures. In order to study individual convex bodies, we are going, here and in the next section, to study the set of all of them (in a given dimension, say  $d$ ) and to introduce algebraic and topological structures on this set.

The duality notion, a very useful one in mathematics (think of the Fourier transform analysis, homology—cohomology, ...), will be introduced through the expedient of a practical problem, that of calculating the volume of a convex body by computer. Looking at polygons for curves in the plane it looks simple:

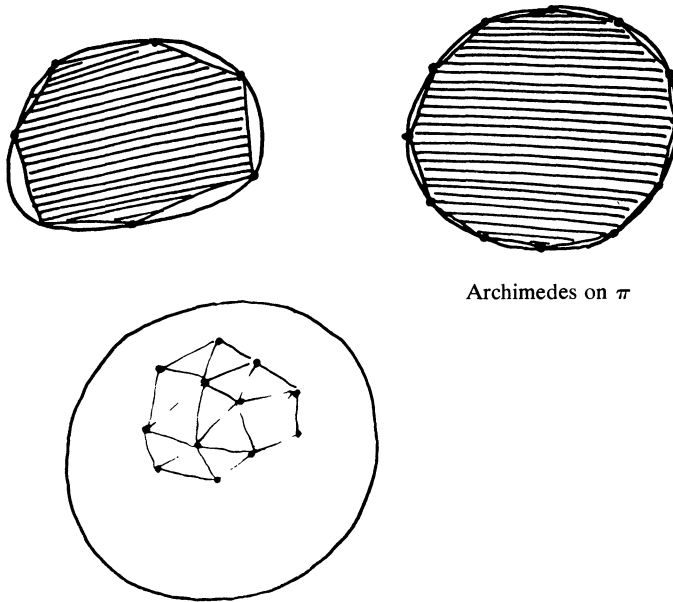

Archimedes on  $\pi$

But in large dimensions we will meet surprises.

### A. Evaluating the volume of a convex body by computer

Let us assume that a convex body  $K$  is described, in the computer, by a membership oracle: input a point  $\vec{x}$ , and the oracle announces whether or not  $\vec{x} \in K$ .

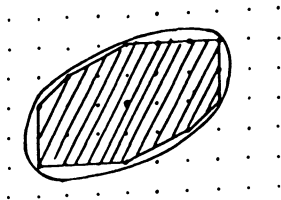

Lovász found, in 1985, a polynomial time algorithm that will give for  $\text{vol}(K)$  a lower bound denoted by  $\underline{\text{vol}}(K)$ . The crucial problem lies in how good that

approximation is. Barany and Füredi, in 1987, show it to be a complete disaster. They prove that for an input which is polynomial in  $d$ , say of  $n = d^a$  points, one cannot *in general* do better than

$$\frac{\text{vol}(K)}{\underline{\text{vol}}(K)} \leq \left( \frac{d}{2ac \log d} \right)^{d/2}.$$

For the proof we consider the simplest convex body, the unit ball  $B^d$ . It can be proved that the maximal volume of a polytope with  $n = d^a$  points contained in  $B^d$ , if denoted by  $V(d, n)$ , obeys

$$\frac{V(d, n)}{\text{vol}(B^d)} \leq \left( \frac{2ac \log d}{d} \right)^{d/2}.$$

The idea is roughly as follows. By Caratheodory's theorem (see section 8.E) every point of the convex hull of  $n = d^a$  points belongs to a simplex of  $\mathbf{R}^d$ . If the points are within distance 1 from the origin, subtle estimates can be obtained for the volume of such a simplex from some of its  $k$ -faces. Then one will have at most  $\binom{n}{k}$  such situations to fill out the polytope and a  $1/k!$  factor coming from the volume of a  $k$ -dimensional simplex. The subtlety now lies in a smart choice for  $k$ . The answer is to take  $k$  as the integral part of  $d/2 \log n$ . Then, because of the formulas given at the beginning of section 3 for the volume of the unit ball  $B^d$  and  $\binom{n}{k} = n!/k!(n - k)!$ , one concludes, after computations using the Stirling formula for evaluating  $p!$  when  $p$  is large, which asserts that

$$\frac{p!}{\sqrt{2p\pi} \left(\frac{p}{e}\right)^p} \xrightarrow{p \rightarrow \infty} 1.$$

A comment: ellipsoids are really the *worst* convex sets for the above inequality. This was proved in 1951 by Macbeath. When the number of points  $n$  is given, for convex bodies  $K$  in a given  $\mathbf{R}^d$ , the bound

$$\frac{\text{Sup}(\text{Volume of a polytope contained in } K \text{ with } n \text{ vertices})}{\text{vol}(K)}$$

is minimum for ellipsoids.

There is still one hope. Try to estimate  $\text{vol}(K)$  from below by  $\underline{\text{vol}}(K)$  with a membership oracle, and try to get an upper bound  $\overline{\text{vol}}(K)$  with a membership and a *separation* oracle together, which are easy to implement. When the computer answers  $x \notin K$  it will at the same time give you a half-space containing  $K$ :

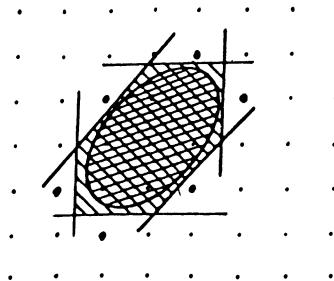

Still according to Lovász, there is also a polynomial algorithm giving  $\text{vol}(K) \geq \underline{\text{vol}}(K)$ . Moreover,

$$\frac{\overline{\text{vol}}(K)}{\underline{\text{vol}}(K)} \leq d^d.$$

This is bad for large  $d$ s. But one might hope to be smart enough in choosing points to get a good

$$\frac{\overline{\text{vol}}(K)}{\underline{\text{vol}}(K)}.$$

This amounts to being able to play with points and half-spaces (or, say, affine hyperplanes). This is precisely what the classical duality in Euclidean spaces achieves for us. The final result will be given in  $C$  below (after this duality has been explained in  $B$ ).

But before we end with a great classic of convexity, let us recall that Minkowski showed just before 1900 that any convex body admits at least one *supporting* hyperplane  $H$  (affine here) for any point  $x$  of its boundary:

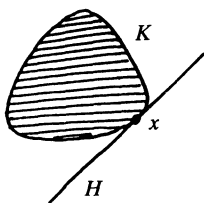

namely,  $K$  lies entirely in one of the two closed half-spaces determined by  $H$ . In most books this is called the Hahn-Banach theorem because Hahn and Banach proved it, much later, in the infinite-dimensional case. This basic result for the study of convex sets shows in particular what we announced in section 2: a closed convex set is the intersection of the closed half-spaces which contain it.

B. The Euclidean duality

We consider  $\mathbf{R}^d$  with its standard Euclidean structure. The duality between points of  $\mathbf{R}^d$  and its affine hyperplanes is geometrically defined as follows:

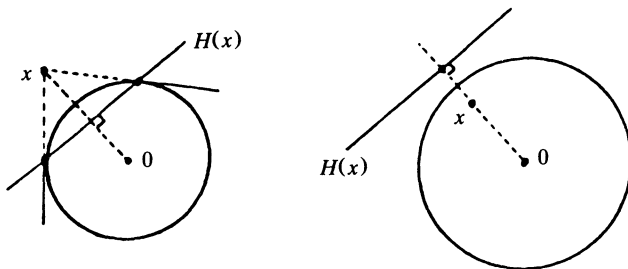

To  $x \neq 0$  associate the line  $0x$  and call the *dual* of  $x$  the hyperplane  $H(x)$  which is orthogonal to  $0x$  and cut it at the point  $x'$  such that  $0x \cdot 0x' = 1$ . Conversely,  $x$ ,

clearly unique for any hyperplane  $H$  not containing  $0$ , is called the *dual* (the *pole*) of  $H$ . Check for yourself in the plane what the dual of the intersection of two lines is in  $\mathbf{R}^2$ . Algebraically, things are much simpler:

$$H(x) = \{y \in \mathbf{R}^d : (x|y) = 1\}$$

where  $(\cdot | \cdot)$  denotes the usual scalar product.

The *polar (reciprocal)* convex body  $K^*$  of a given convex body  $K$  is either the convex hull of the poles of the supporting hyperplanes of  $H$  or the intersection of the half spaces bounded by the hyperplanes which are the dual of the points of  $K$  (of course you need to use the boundary points of  $K$ ). This duality is excellent if  $K$  is a convex body that contains  $0$  in its interior. From now on only such  $K$ 's will be considered. Then  $(K^*)^* = K$ .

Examples are:

- (i) the unit ball  $B^d$  is its own dual
- (ii) ellipsoids have ellipsoids as duals; check that then

$$\text{vol}(E)\text{vol}(E^*) = (\text{vol}(B^d))^2 = \beta^2(d)$$

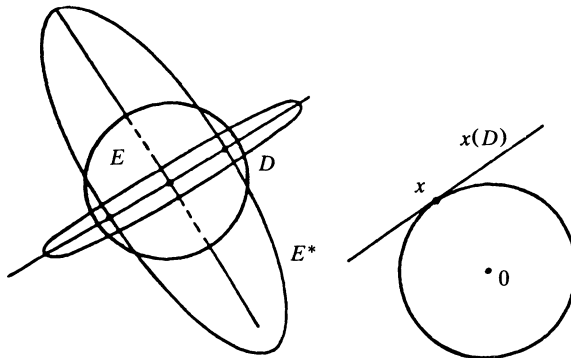

- (iii) the dual of a cube is called a *cross polytope*. Precisely the dual of  $[-1, 1]^d = K$  is  $K^* =$  convex hull of the point  $\pm e_i$  (where  $\{e_i\}$  is the standard base). Note that a cube has  $2^d$  vertices, the cross polytope only  $2d$ . Note here

$$\text{vol}(K)\text{vol}(K^*) = 2^d \frac{2^d}{d!} = \frac{4^d}{d!}.$$

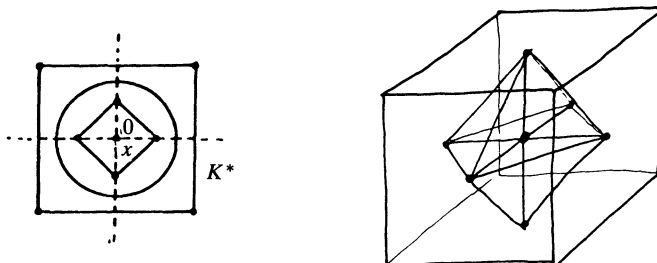

- (iv) more generally the dual of a polytope is a polytope, the duality exchanging vertices of one with faces of the other.



C. Back to estimating volumes: the invariant  $\text{vol}(K) \text{vol}(K^*)$

Here we work with convex sets  $K$  symmetric in the origin. The picture and the way Lovász obtains  $\overline{\text{vol}}(K)$  and  $\text{vol}(K)$  show that if we want to compute  $\text{vol}(B^d)$  by his method, we have to estimate

$$\boxtimes \quad \frac{\overline{\text{vol}}(B^d)}{\text{vol}(B^d)} \geq \frac{\text{vol}(K^*)}{\text{vol}(K)},$$

where  $K$  is one of the polytopes contained in  $B^d$  as in the figure in subsection A. We rewrite the right-hand quotient of  $\boxtimes$  as

$$\text{vol}(K)\text{vol}(K^*) \left( \frac{\text{vol}(B^d)}{\text{vol}(K)} \right)^2 \frac{1}{(\text{vol}(B^d))^2}.$$

The last two terms are estimated above. The plan is to work with a smart  $K$ , that is to approximate  $B^d$  by  $K$  such that  $\text{vol}(K)\text{vol}(K^*)$  is very small.

Note that  $\text{vol}(K)\text{vol}(K^*)$  is an invariant of the linear shape of  $K$  only because linear transformations will affect  $\text{vol}(K)$  by  $\det f$  when it affects  $\text{vol}(K^*)$  by  $(\det f)^{-1}$ . It was conjectured by Mahler that for any  $d$  and any  $K$ :

$$\beta^2(d) \geq \text{vol}(K)\text{vol}(K^*) \geq \frac{4^d}{d!},$$

the left inequality being characteristic of ellipsoids and the right one of cubes or cross polytopes.

Assume Mahler's conjecture on the right side. Then the hopes mentioned above are dashed. Because then always

$$\frac{\text{vol}(K^*)}{\text{vol}(K)} \geq \left( \frac{d}{ae \log d} \right)^d$$

using the above results.

As to Mahler's double conjecture, the situation today is the following. The left bound is true and characterizes the ellipsoid. The bound was proved by Blaschke for  $d = 2, 3$  and by L. Santalo (with some restrictions) for any  $d$ . The fact that equality characterizes the ellipsoid for any  $d$  was settled only by Saint Raymond in 1981. The exact right-hand bound is unknown today even for  $d = 3$ . It is known only for  $d = 2$  (try it yourself to feel the difficulty there already is for  $d = 2$ ). In 1985, J. Bourgain and V. Milman showed that the order of magnitude conjectured by Mahler is the right one. There exists  $c > 0$

$$\text{vol}(K)\text{vol}(K^*) \geq \frac{c^d}{d!} \forall K \forall d.$$

So the error on computing volumes will have to be as bad as

$$c \left( \frac{d}{\log d} \right)^d.$$

Thus "it is impossible to compute the volume with a decent error in polynomial time." In other words a computation of volume applicable to any convex body should be of another type.

The Bourgain-Milman proof is quite involved. It uses probability theory and fine estimates, see [8], [5].

Note that the Mahler conjecture is useful in a completely different context, that of simultaneous approximations of real numbers by rationals, see [17], page 31.

D. The Minkowski addition

For  $K, H$  convex sets of  $\mathbf{R}^d$ , the set defined as

$$K + H = \{x + y : x \in K, \quad y \in H\}$$

is still convex.

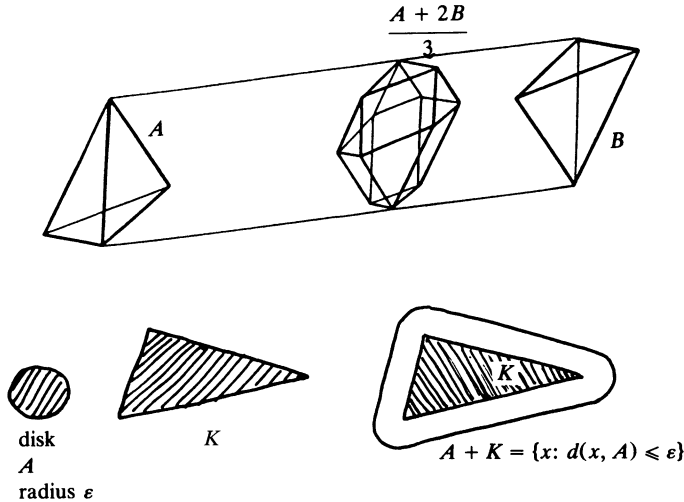

Note that if you change the origin in  $\mathbf{R}^d$  the new  $K + H$  will differ from the old one by only a translation, so it can be considered as well-defined in shape. The notion is then affine. More generally,  $\lambda K + \mu H = \{\lambda x + \mu y : x \in K, y \in H\}$  is still convex for any  $\lambda, \mu > 0$ . The picture below shows

$$\frac{A + 2B}{3} = \frac{1}{3}A + \frac{2}{3}B$$

for two simplices in  $\mathbf{R}^3$  and also that the sum of some  $K$  with a ball of radius  $\epsilon$  is nothing but the set of points within a distance  $\epsilon$  of  $K$ . We have no time to elaborate on this. Suffice it to note that it is the starting point of one of the first rigorous proofs of the standard isoperimetric inequality in  $\mathbf{R}^d$  which states that among all convex bodies of given volume, balls are those with the smallest boundary volume (here  $(d - 1)$ -volume which is length when  $d = 2$  and area when  $d = 3$ ), see section 8. Let us mention here the basic Brunn-Minkowski inequality

$$(\text{vol}(A + B))^{1/d} \geq (\text{vol}(A))^{1/d} + (\text{vol}(B))^{1/d}.$$

This was essentially discovered by Brunn in 1888. The reader will easily see that this is exactly equivalent to the claim that the  $(d - 1)^{-1}$ th power of the  $(d - 1)$ -dimensional volume of the sections of a given convex body in  $\mathbf{R}^d$  is a concave function when the cutting hyperplane moves from the left to the right: see section 5.A.

In both of the above figures, the Minkowski addition has a *regularization effect*; in both cases  $K + H$  has a smoother boundary than  $K, H$ . This is naïve for the general case but was discovered only in 1988 by Kieselmann. Even when  $K$  and  $H$  have the most regular boundary possible—namely,  $C^\infty$ , or real analytic or even more: algebraic—the boundary of  $K + H$  can be non-smooth. The results are of local nature. The negative one consists simply of the epigraphs  $K, H$  (see section 4) of  $x^4/4$  and  $x^6/6$  for which

$$K + H \text{ is the epigraph of } \frac{x^6}{6} - \frac{3}{4}|x|^{20/3} + \text{something of class } C^7.$$

So it is only six times differentiable. But it is the worst possible. The positive result is: if the boundary of  $K$  and the boundary of  $H$  are of class  $C^\infty$ , then the boundary of  $K + H$  is always of class  $C^{20/3} = C^{6+(2/3)}$ . See [26].

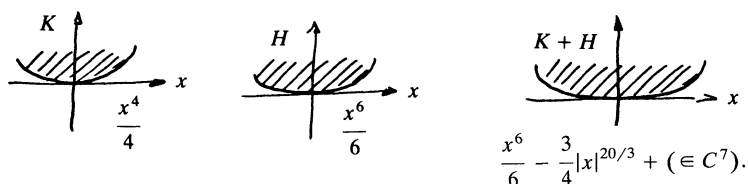

So the Minkowski addition has no regularizing effect when regularity means *local* smoothness (differentiability properties). But it does have a *global* regularizing effect when regularity means being close to ellipsoids. It was indeed proved by Vitali Milman that for any convex body in  $\mathbf{R}^d$  there exist two affine isomorphisms  $A$  and  $B$  of  $\mathbf{R}^d$  such that if one sets  $T = K + A(K)$  then the dual  $T^*$  of  $T$  has the advantage that  $T^* + B(T^*)$  has a Banach-Mazur distance to the sphere always bounded by a number independent of the dimension  $d$ .

**7. Topology on the set of all convex bodies: intuition is dangerous**

A. Topology

We are going to see with the help of topology that intuition can again be misleading. Namely that if any convex body has a boundary which is almost everywhere  $C^1$  and  $C^2$  differentiable, in the set of all convex bodies almost every convex body has a boundary which is never everywhere  $C^2$ . For even worse, see below. Topology is needed to give a precise meaning to “almost every convex body.”

For the sake of simplicity we work in the set  $\mathcal{K}$  of all convex bodies symmetric in the origin of a given  $\mathbf{R}^d$ . We recall that these are convex sets which are also compact and with a non-void interior. We specify  $\mathcal{K}$  in  $\mathbf{R}^d$  only when needed. Topology on the convex body set is best given by the *Banach-Mazur metric*.

We have already seen in section 3 the Banach-Mazur distance on  $\mathcal{K}$ . It has the advantage of being linear-invariant. But, *stricto sensu*, it is a distance in fact only when convex sets which differ by some linear transformation are identified. A non-linear-invariant distance is the Hausdorff one. Fix on  $\mathbf{R}^d$  some Euclidean metric. Then  $d(K, H)$  is defined by the smallest  $\varepsilon$  such that  $K \subset H + \varepsilon B^d$  and  $H \subset K + \varepsilon B^d$ , i.e.,  $K$  is within distance  $\varepsilon$  from  $H$  and conversely. It is easy to

prove that the Hausdorff distance gives the same topology on  $\mathcal{K}$  as the Banach-Mazur one (just beware of the quotient to be done).

Remark that no reasonable measure on  $\mathcal{K}$  is known. To define the analogue of “almost every” without measure but when one has a topology, we use Baire’s idea: *negligible* sets will be by definition those which are a denumerable union of sets with void interior (these latter are also called *meager*).

#### B. Probable regularity of the boundary of a convex set

Consider a convex body  $K$  and its boundary  $\partial K$ . We want to study the regularity of this set which is a curve when  $d = 2$  and a surface when  $d = 3$ . In general a hypersurface. This is a local question. In particular, taking  $x \in \partial K$  and a supporting hyperplane  $H$  at  $x$  we can locally consider  $K$  as the epigraph of a convex numerical function  $f: U \rightarrow \mathbf{R}$  where  $U$  is a neighborhood of  $x$  in  $H$ . Then  $\partial K$  will locally coincide with the graph of  $f$ .

We can apply the results quoted in section 4. So if we build the totality of  $\partial K$  with such graphs we know that  $\partial K$  is almost everywhere (this for the natural measure on  $\partial K$  obtained from the Lebesgue measures on the  $H$ ’s through the  $f$ ’s) a differentiable manifold of class  $C^2$  (in particular almost everywhere of class  $C^1$ ). The question we address now is: what are the chances for  $\partial K$  to be everywhere of class  $C^1$  when we pick  $K$  at random in  $\mathcal{K}$ . A nice answer was provided by Klee in 1959. He proved that, up to a negligible set in  $K$ ,  $\partial K$  is always  $C^1$  everywhere, hence a nice  $C^1$ -submanifold of  $\mathbf{R}^d$  (of codimension one).

In contrast to this the  $C^2$  situation is dramatically different: Gruber in 1977 proved that the set of  $K$  in  $\mathcal{K}$  whose  $\partial K$  is almost everywhere  $C^2$  is negligible. Worse: Zamfirescu in 1980 proved that, except in a negligible set,  $\partial K$  has horrible curvature properties: curvature does not exist on a non-denumerable set and where it does exist it is equal to zero! The reason is that that is exactly how the curvature of a polytope behaves and it so happens that in  $\mathcal{K}$  polytopes are dense. See [20], [37].

### **8. Brief survey of other important topics in convexity**

For lack of space we cannot treat these in detail but only briefly mention what they are about and provide some references.

#### A. Inequalities

The most important one is Brunn-Minkowski’s mention in section 6. It yields the classical isoperimetric inequality in  $\mathbf{R}^d$ . For other proofs, other inequalities, especially the *mixed volume* inequalities, which are quite deep and hard to prove, see [11], [27].

#### B. Almost spherical sections, concentration phenomena, applications

The isoperimetric inequality on spheres was used by Paul Lévy back in the ’30s to prove concentration properties for functions. It was used by Milman in 1971 to prove the inspiring theorem of Dvoretzky (1961) that any convex body admits almost ellipsoidal sections for suitable codimension. This was the starting point of a whole series of recent works in the same vein. Its importance lies, besides its strong geometrical appeal, in its application (through the so-called asymptotic methods) to Banach spaces of infinite dimension. For this see [28].

### C. Convexity in analysis

Recently discoveries have been made of various functions which are log-concave, like  $\text{vol}^{1/d}$  in the Brunn-Minkowski inequality. It seems to have started with the important Brascamp-Lieb inequality which solved, in particular, the long-standing conjecture: the level lines of the first eigenfunction of the Dirichlet problem of a convex domain are convex hypersurfaces. In fact the complete heat kernel has a convexity property. See [3], [9].

### D. Packing and covering

These two notions are very important. They have been connected, since Minkowski, with number geometry, rational approximations. But also with error detecting codes. Interesting references are [13], [17].

They are also connected with notions of entropy and infinite-dimensional Banach geometry: see [28].

### E. Caratheodory, Helly, Radon

Three elementary (and very visualizable) statements are:

- |                                   |  |
|-----------------------------------|--|
| the <i>Caratheodory theorem</i> : | the convex hull of a set in $\mathbf{R}^d$ is generated by the positive barycenters of its $(d + 1)$ -uples  |
| the <i>Helly theorem</i> :        | a family of compact convex sets has a non-void intersection as soon as any $d + 1$ of its sets has a non-void intersection   |
| the <i>Radon theorem</i> :        | let $T$ be a subset of at least $d + 2$ points in $\mathbf{R}^d$ . Then there always exists a disjoint decomposition $T = T_1 \cup T_2$ such that $\text{conv}(T_1) \cap \text{conv}(T_2) = \emptyset$ . |

None of these theorems are very hard to prove. Nor are they too elementary. The very interesting fact is that any one of them easily implies the two others. Moreover they have an enormous number of applications and are linked a great deal with combinatorics. See, for example [15], [18].

### F. Convexity in other spaces

Convexity can be defined in more general spaces than the Euclidean ones. In particular, it is widely used nowadays in Riemannian Geometry. See [4], [31].

### G. Last but not least: The moment map

This map was introduced very recently. The fact that it is convex in certain cases is very powerful and turns out to be a surprising link between mechanics, Kähler geometry, Lie group theory and eigenvalues of matrices. See [1], [25].

## REFERENCES

Besides the items mentioned within the text and listed thereafter, the reader will find systematic (although never, of course, exhaustive) treatment of convexity in [6], [7], [10], [12], [16], [22], [27], [35].

1. M. F. Atiyah, Angular Momentum, Convex Polyhedra and Algebraic Geometry, *Proc. Edinburgh Math. Soc.* 1983 (26) 121–138.
2. K. Ball, Cube slicing in  $\mathbf{R}^n$ , *Proceed. A.M.S.*, 97 (1986) 465–473.
3. \_\_\_\_\_, Logarithmically concave functions and sections of convex sets in  $\mathbf{R}^n$  *Studia Math.*, 88 (1988) 69–84.

4. W. Ballmann, M. Gromov, and V. Schroeder, *Manifolds of Negative Curvature*, Birkhäuser, 1985.
5. I. Barany and Z. Füredi, Computing the volume is difficult, *Discrete and Computational Geometry*, 2 (1987) 319–326.
6. M. Berger, *Geometry I and II*, Springer, 1987.
7. T. Bonnesen and W. Fenchel, *Theorie der konvexen Körper*, Springer (reprint), 1974.
8. J. Bourgain and V. D. Milman, New volume ratio properties for convex symmetric bodies in  $\mathbf{R}^n$ , *Inventiones Math.*, 88 (1987) 319–341.
9. H. J. Brascamp and E. H. Lieb, Best constants in Young's inequality, its converse and its generalization to more than three functions, *Advances in Math.*, 20 (1976) 151–173.
10. A. Bronsted, *An Introduction to Convex Polytopes*, Springer, 1983.
11. J. D. Burago and V. A. Zalgaller, *Geometric Inequalities*, Springer, 1988.
12. H. Busemann, *Convex Surfaces*, Interscience, 1958.
13. J. H. Conway and N. J. A. Sloane, *Sphere Packings, Lattices and Groups*, Springer, 1988.
14. J. Coolidge, *Algebraic Plane Curves*, Dover, 1959.
15. L. Danzer, B. Grünbaum, and V. Klee, Helly's theorem and its relatives, *AMS Proc. Sympos.*, 7, 1963.
16. H. G. Eggleston, *Convexity*, Cambridge University Press, 1958.
17. P. Erdős, P. M. Gruber, and J. Hammer, *Lattice Points*, Pitman Monographs and Surveys in Pure and Applied Mathematics, No. 39, John Wiley, 1989.
18. W. J. Ellison, Waring's problem, this MONTHLY, 78 (1971) 10–36.
19. M. Grötschel, L. Lóvász, and A. Schrijver, *Geometric Algorithms and Combinatorial Optimization*, Springer, 1988.
20. P. M. Gruber, Aspects of convexity and its applications, *Expositiones Math.*, 2 (1984) 47–83.
21. P. M. Gruber and J. M. Wills (editors), *Convexity and its Applications*, Birkhäuser, 1983.
22. B. Grünbaum, *Convex Polytopes*, Interscience, 1967 (or U.M.I. Out-of-Print Books on Demand, 1989).
23. B. Grünbaum and G. C. Shephard, Tilings with Congruent Tiles, *Bull. AMS*, 3 (1980) 951–973.
24. \_\_\_\_\_, *Tilings and Patterns*, Freeman, 1987.
25. V. Guillemin and S. Sternberg, Convexity properties of the moment mapping, *Invent. Math.*, 67 (1982) 491–513.
26. C. O. Kiselman, Smoothness of vector sums of plane convex sets, *Math. Scand.*, 60 (1987) 239–252.
27. K. Leichtweiss, *Konvexe Mengen*, Springer, 1980.
28. V. D. Milman and G. Schechtman, *Asymptotic Theory of Finite Dimensional Normed Spaces*, Springer Lecture Notes in Math., No 1200, 1986.
29. T. Oda, *Convex Bodies and Algebraic Geometry*, Springer, 1988.
30. C. A. Rogers, *Packing and Covering*, Cambridge University Press, 1964.
31. K. Shiohama, Topology of complete and non-compact manifolds, in *Advanced Studies in Pure Mathematics*, No 3: *Geometry of Geodesics and Related Topics*, Kinokuniya and North Holland, 1984.
32. R. P. Stanley, *Combinatorics and Commutative Algebra*, Birkhäuser, 1983.
33. S. J. Szarek and M. Talagrand, An isomorphic version of the Sauer-Shelah lemma and the Banach-Mazur distance to the cube, preprint IHES, 1988.
34. J. Tölke and J. M. Wills (editors), *Contributions to Geometry*, Birkhäuser, 1979.
35. F. A. Valentine, *Convex Sets*, McGraw-Hill, 1964.
36. R. J. Walker, *Algebraic Curves*, Princeton Univ. Press, 1950.
37. T. Zamfirescu, Nearly all convex bodies are smooth and strictly convex, *Monatshefte für Math.*, 103 (1987) 57–62.
38. \_\_\_\_\_, Curvature properties of typical convex surfaces, *Pacific J. Math.*, 131 (1988) 191–207.