



IBM Software Group

# Introduction to BPMN

Stephen A. White, BPM Architect, IBM

October 16, 2006

**WebSphere** software



**ON DEMAND BUSINESS™**

© IBM Corporation

# Introduction

- This tutorial introduces business process modeling using the BPMN process modeling standard. This session will show how BPMN can support different methodologies as well as different modeling goals (e.g., orchestration and choreography), using actual business processes as examples. Sample business models will also be presented and explored to illustrate the main concepts and notational innovations. Two short exercises (on paper) will give students the feel of modeling with the major BPMN model elements.



# Topics

- **BPMN Background**
- Basic Concepts
- Exercise 1
- Additional Concepts
- Process Modeling Methodologies
- Orchestration vs. Choreography
- Exercise 2
- Summary



# What is Process Modeling?

- The capturing of an ordered sequence of business activities and supporting information
  - ▶ Business processes describe how a business pursues its objectives
- There are different levels of process modeling:
  - ▶ Process Maps – simple flow charts of the activities
  - ▶ Process Descriptions – flow charts extended with additional information, but not enough to fully define actual performance
  - ▶ Process Models – flow charts extended with enough information so that the process can be analyzed, simulated, and/or executed
  - ▶ BPMN supports each of these levels



# What is BPMN?

- BPMN is flow-chart based notation for defining Business Processes

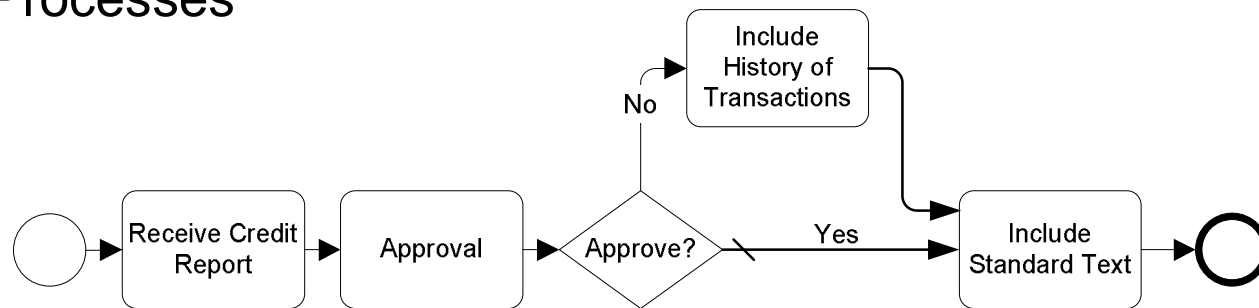

- BPMN is an agreement between multiple modeling tools vendors, who had their own notations, to use a single notation for the benefit of end-user understand and training
- BPMN provides a mechanism to generate an executable Business Process (BPEL) from the business level notation
  - ▶ A Business Process developed by a business analyst can be directly applied to a BPM engine instead of going through *human* interpretations and translations into other languages



# Origins of BPMN

- The Business Process Management Institute (BPMI—now a part of the OMG) develops BPML (an XML process execution language) and realizes need for a graphical representation
  - ▶ BPML was later replaced by BPEL as the target execution language
- August, 2001, the Notation Working Group is formed. The group was composed of 35 companies, organizations, or individuals.
- BPMN 1.0
  - ▶ May, 2004, the BPMN 1.0 specification was released to the public.
  - ▶ February, 2006, BPMN 1.0 was adopted as an OMG standard
  - ▶ Currently, there are 39 companies that have implementations of BPMN



# A BPM Hourglass

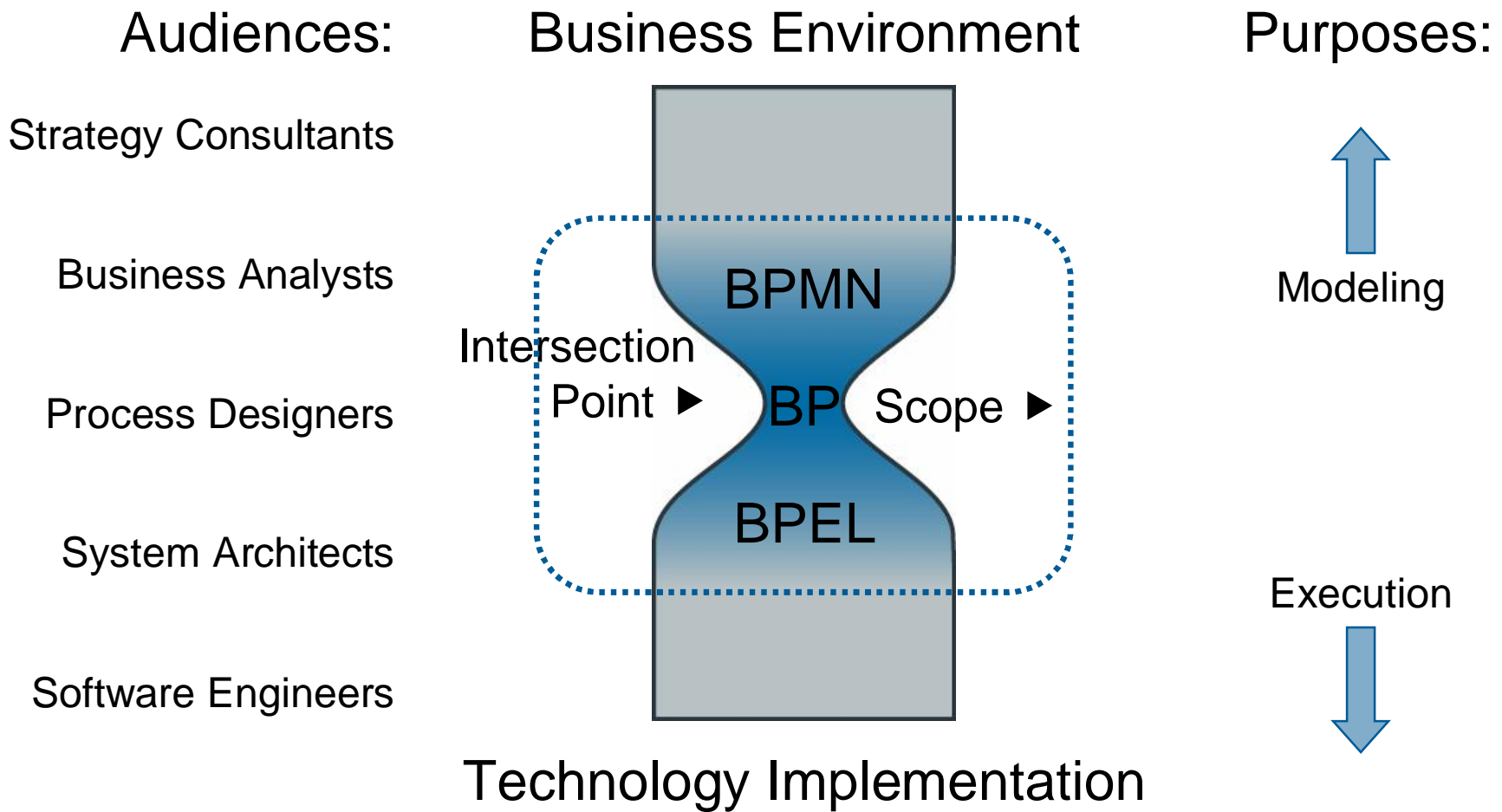

# BPMN Development Drivers

- Must be acceptable and usable by the business community
- Must be able to generate executable processes (e.g., BPEL) through a BPMN Model (a combination of graphical elements and supporting information (attributes))
- Although executable processes triggered the development of BPMN, it was expected that BPMN would be used for more general business purposes
- BPM is intended to be Methodology Agnostic
  - ▶ Methodologies will give guidance as to the purpose and level of detail for modeling
  - ▶ BPMN is as complex as it needs to be. Just use what you need...





# Topics

- BPMN Background
- **Basic Concepts**
- Exercise 1
- Additional Concepts
- Process Modeling Methodologies
- Orchestration vs. Choreography
- Exercise 2
- Summary



# Diagram Elements

**Activities**



**Events**



**Gateways**

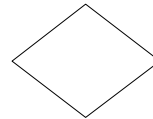

**Connectors**

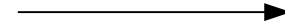

[Back](#)



# Diagram Elements, Cont.

## Flow Objects

### Events



### Activities



### Gateways

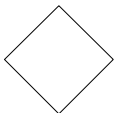

## Connectors

### Sequence Flow

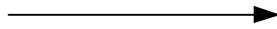

### Message Flow



### Association

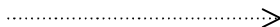

## Artifacts

### Data Object

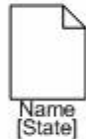

Name  
[State]

### Text Annotation



### Group



## Swimlanes

### Pool



### Lanes (within a Pool)



[Back](#)



# Activities

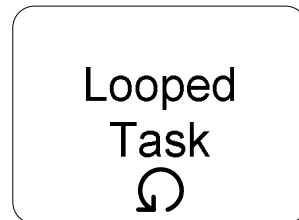
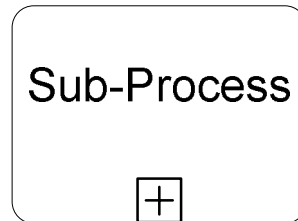

- An activity is work that is performed within a business process. An activity can be atomic or non-atomic (compound). The types of activities that are a part of a Process Model are: **Sub-Process**, and **Task**
- Activities are rounded rectangles
- They can be performed once or can have internally defined loops



# Tasks

- A Task is an atomic activity that is included within a Process. A Task is used when the work in the Process is not broken down to a finer level of Process Model detail
- There are specialized types of Tasks for sending and receiving, or user-based Tasks, etc.
- Markers or icons can be added to Tasks to help identify the type of Task
  - ▶ Markers must not change the footprint of the Task or conflict with any other standard BPMN element

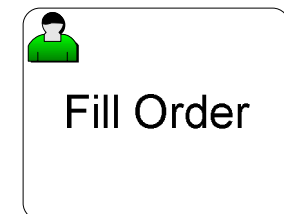
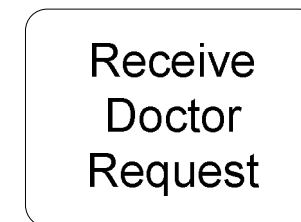
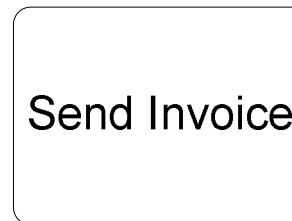

# Sub-Processes

- Sub-Processes enable hierarchical Process development
- A Sub-Process is a compound activity that is included within a Process. It is compound in that it can be broken down into a finer level of detail (a Process) through a set of sub-activities
- For a collapsed version of a Sub-Process, The details of the Sub-Process are not visible in the Diagram. A “plus” sign in the lower-center of the shape indicates that the activity is a Sub-Process and has a lower-level of detail.
- For an expanded version of a Sub-Process, the details (a Process) are visible within its boundary.
- There are two types of Sub-Processes: Embedded and Independent (Re-usable)

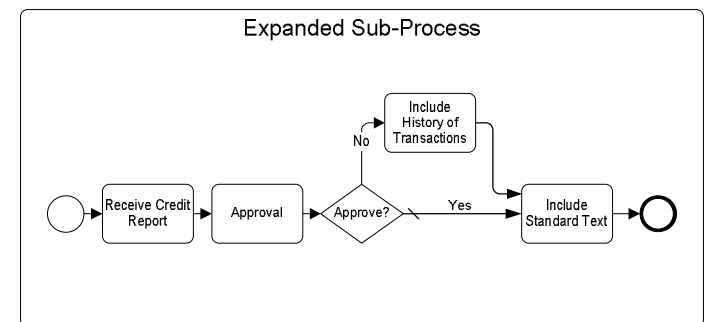
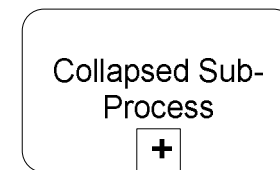

# Events

Start



Intermediate



End



- An **Event** is something that “happens” during the course of a business process. These Events affect the flow of the Process and usually have a trigger or a result. They can start, interrupt, or end the flow
- Events are circles
  - ▶ The type of boundary determines the type of Event



# Start Events

- Start Events indicate where a Process will begin
- There are different “Triggers” that indicate the specific circumstances that start the Process
  - ▶ None Start Events are used to mark the start of Sub-Processes or when the start is undefined
  - ▶ The Link Start Event will be removed in the next version of BPMN
  - ▶ Any one of the Triggers included in a Multiple Start Event will start the Process

None

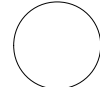

Message



Timer

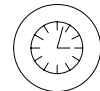

Rule



Link



Multiple





# Intermediate Events

- Intermediate Events occur after a process has been started and before a process is ended
- There are different “Triggers” that indicate the specific circumstances of the Event
- They can be placed in the normal flow of the Process or attached to the boundary of an activity

**None**



**Message**



**Timer**



**Error**



**Compensation**



**Rule**



**Link**



**Multiple**



## Intermediate Events (Normal Flow)

- Events that are placed within the process flow represent things that happen during the normal operations of the process
- They can represent the response to the Event (i.e., the receipt of a message)
- They can represent the creation of the Event (i.e., the sending of a message)

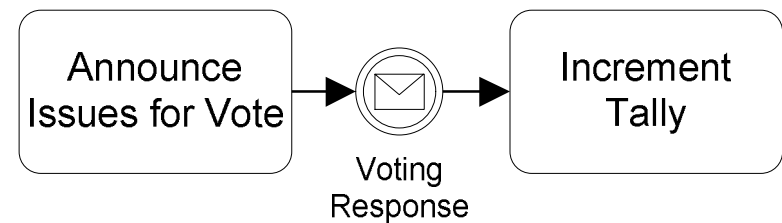

## Intermediate Events (Attached to Boundary)

- Events that are attached to the boundary of an activity indicate that the activity should be interrupted when the Event is triggered
  - ▶ They can be attached to either Tasks or Sub-Processes
- They are used for error handling, exception handling, and compensation

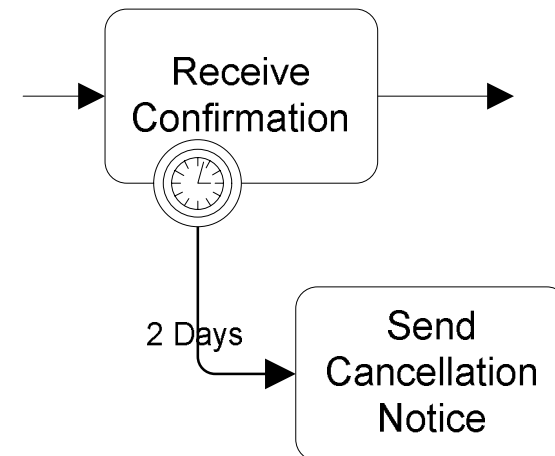

# End Events

- End Events indicates where a process will end
- There are different “Results” that indicate the specific circumstances that end the Process
  - ▶ None Start Events are used to mark the start of Sub-Processes or when the start is undefined
  - ▶ The Link End Event will be replaced in the next version of BPMN (probably with a Signal)

None



Message



Error



Compensation



Link



Terminate



Multiple



# Gateways

**Exclusive**  
Data-Based

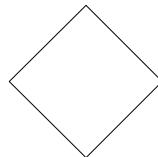

**Event-Based**

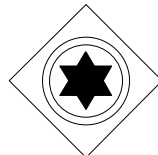

**Inclusive**

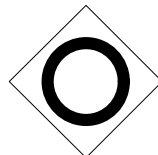

**Complex**

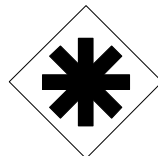

**Parallel**

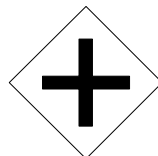

- **Gateways** are modeling elements that are used to control how Sequence Flows interact as they converge and diverge within a Process
- All types of Gateways are diamonds
  - ▶ Different internal markers indicate different types of behavior
  - ▶ All Gateways both split and merge the flow
- *If the flow does not need to be controlled, then a Gateway is not needed. Thus, a diamond represents a place where control is needed*



# Exclusive Gateways

- Exclusive Gateways (Decisions) are locations within a business process where the Sequence Flow can take two or more alternative paths. This is basically the “fork in the road” for a process.
- Only one of the possible outgoing paths can be taken when the Process is performed
- There are two types decision mechanism:
  - ▶ Data (e.g., condition expressions)
  - ▶ Events (e.g., the receipt of alternative messages)
- They are also used to merge Sequence Flow
  - ▶ The merging behavior may change in the next version of BPMN



# Exclusive Gateways, Based on Data

- These are the most commonly used type of Gateways.
  - ▶ They can be shown with or without an internal “X” marker. Without is the most common use.
- The Gateway (Decision) creates alternative paths based on defined conditions

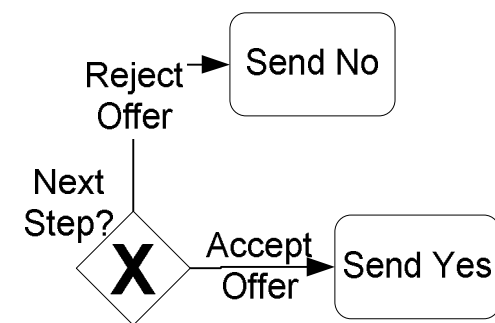
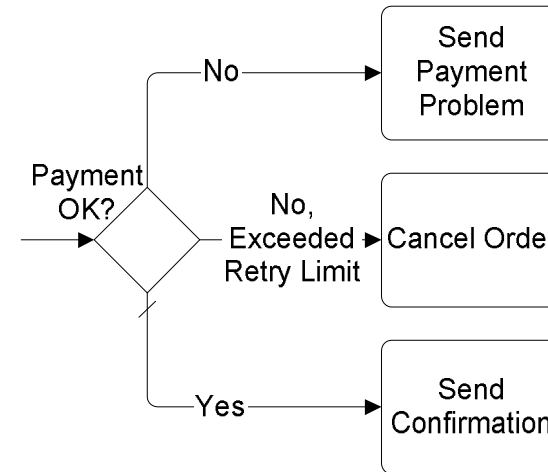

# Exclusive Gateways, Based on Events

- This type of Decision represents a branching point in the process where the alternatives are based on events that occurs at that point in the Process, rather than conditions
- The Multiple Intermediate Event is used to identify this Gateway
- The Event that follow the Gateway Diamond determine the chosen path
  - ▶ The first Event triggered wins

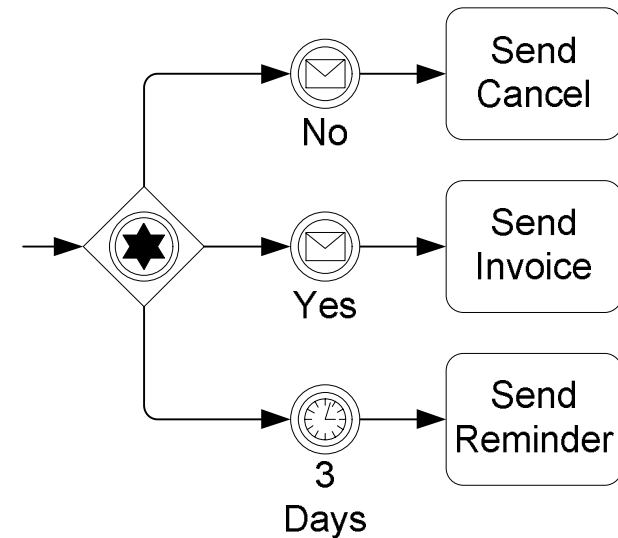



# Inclusive Gateways

- Inclusive Gateways are Decisions where there is more than one possible outcome
- The “O” marker is used to identify this Gateway
- They are usually followed by a corresponding merging Inclusive Gateway

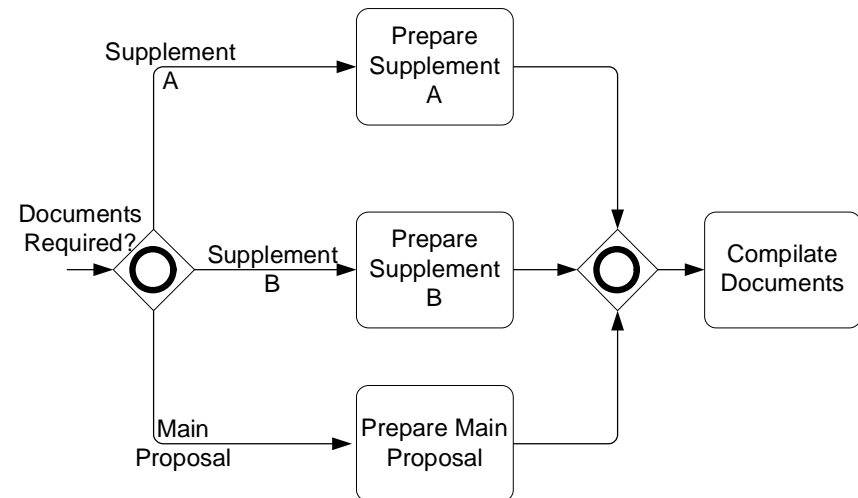

# Complex Gateways

- Complex Gateways are Decisions where there is more advanced definitions of behavior can be defined
- The asterisk marker is used to identify this Gateway
- Complex behavior can be defined for both the merging and splitting behavior

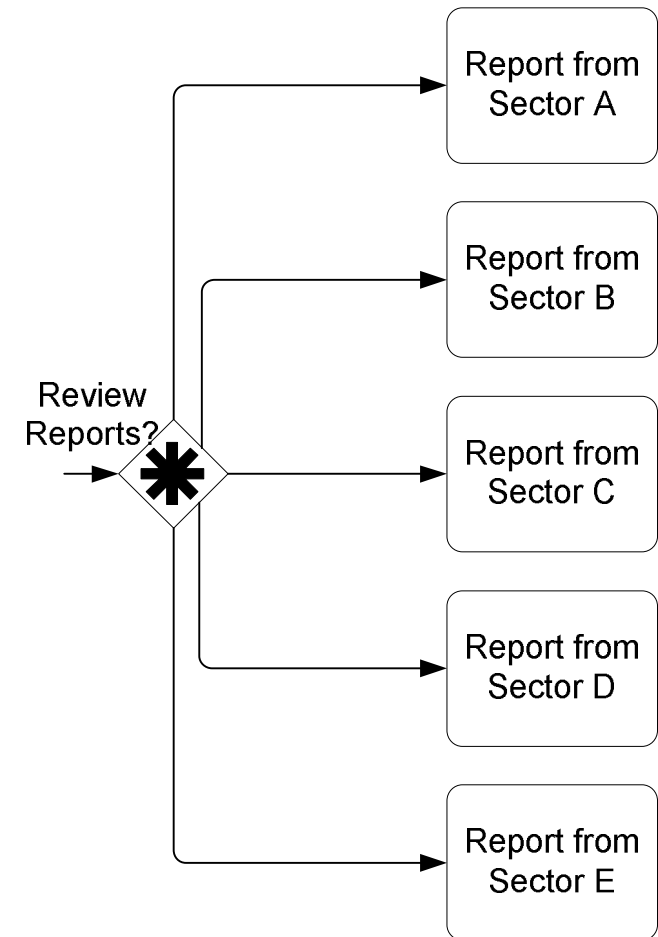

# Parallel Gateways

- Parallel Gateways are places in the Process where multiple parallel paths are defined
  - ▶ They are not required for forking in most situations.
  - ▶ They can be used for methodological purposes
- The “+” marker is used to identify this Gateway
- The Gateway is also used to synchronize (wait for) parallel paths

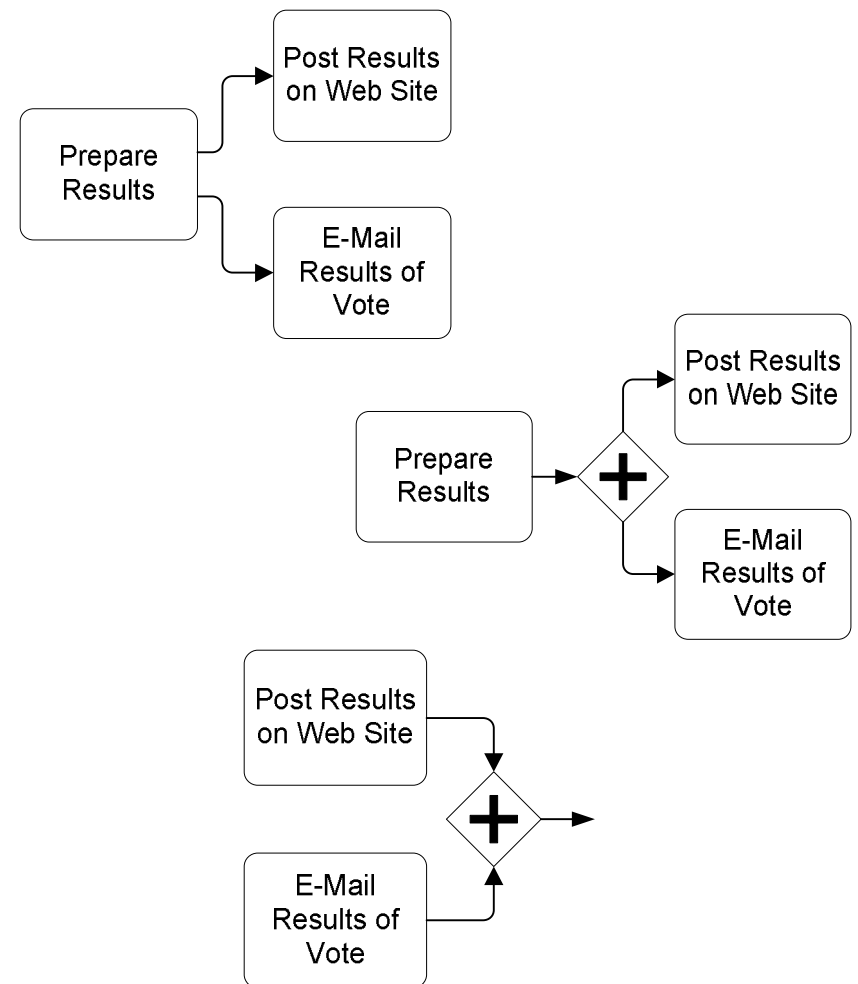

# Connectors

## Sequence Flow



## Message Flow

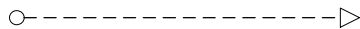

## Association

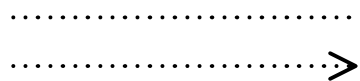

- A **Sequence Flow** is used to show the order that activities will be performed in a Process
- A **Message Flow** is used to show the flow of messages between two entities that are prepared to send and receive them
- An **Association** is used to associate data, information and artifacts with flow objects



# Sequence Flow

- A Sequence Flow is used to show the order that activities will be performed in a Process
- The source and target must be one of the following objects: Events, Activities, and Gateways
- A Sequence Flow cannot cross a Sub-Process boundary or a Pool boundary

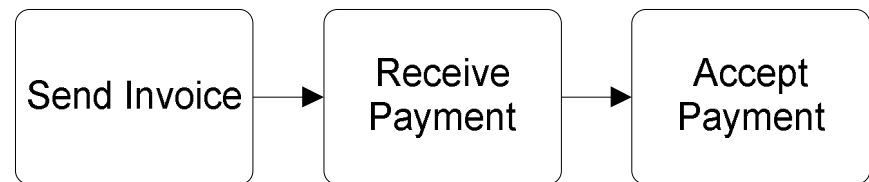

# Conditional Sequence Flow

- A Sequence Flow MAY have a defined condition if it exits an activity
  - ▶ Such an activity must have at least two Sequence Flows
- The condition has to be True to allow the flow to continue down the Sequence Flow
  - ▶ A mini-diamond shows that the Sequence Flow has a condition
- At least one of the outgoing Sequence Flow must be chosen during Process performance

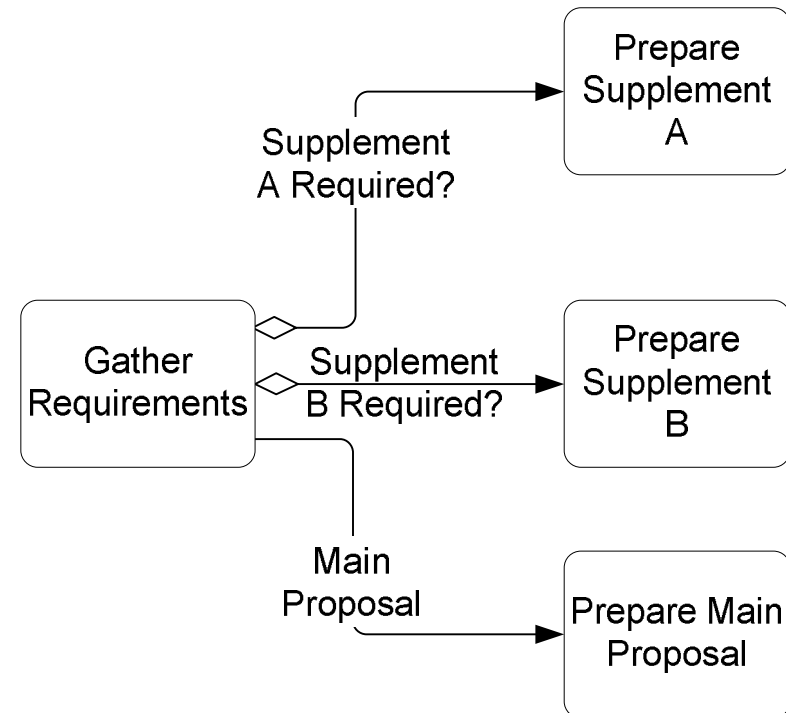

# Default Sequence Flow

- A Sequence Flow that exits an Exclusive or Inclusive Gateway may be defined as being the default path
  - ▶ A hatch mark at the line beginning shows the default Sequence Flow
- The default path is chosen only if all the other conditions of the Gateway are False

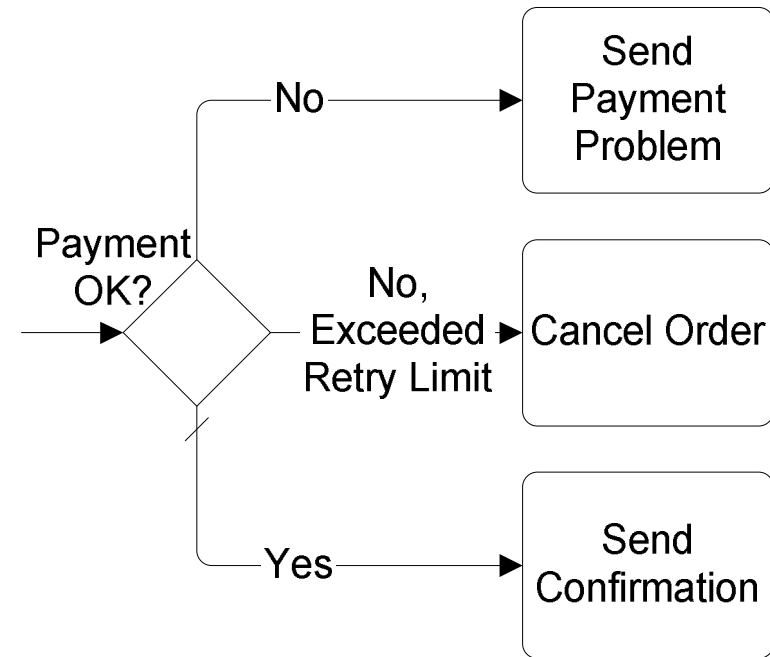

# Message Flow

- A Message Flow is used to show the flow of messages between two Participants of Process
  - ▶ In BPMN, separate Pools are used to represent the Participants
- A Message Flow can connect to the boundary of the Pool or to an object within the Pool
- Message Flow are not allowed between objects within a single Pool

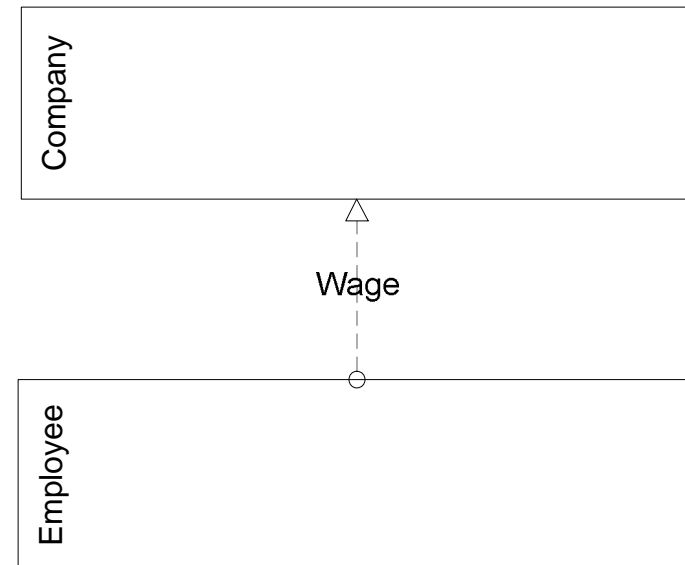



# Associations

- An Association is used to associate objects to one another (such as Artifacts and Activities)
- Associations are used to show how data is input to and output from Activities
- Text Annotations can be Associated with objects

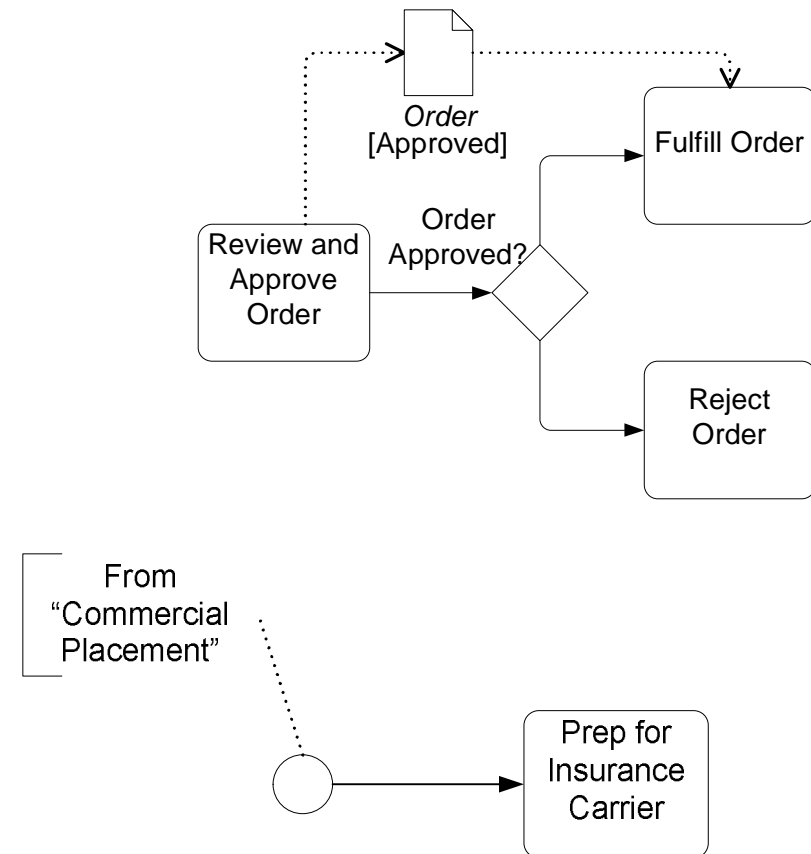

# Swimlanes

- BPMN uses the concept known as “swimlanes” to help partition and/organize activities
- There are two main types of swimlanes: Pool and Lane
  - ▶ Pools represent Participants in an interactive (B2B) Business Process Diagram
  - ▶ Lanes represent sub-partitions for the objects within a Pool

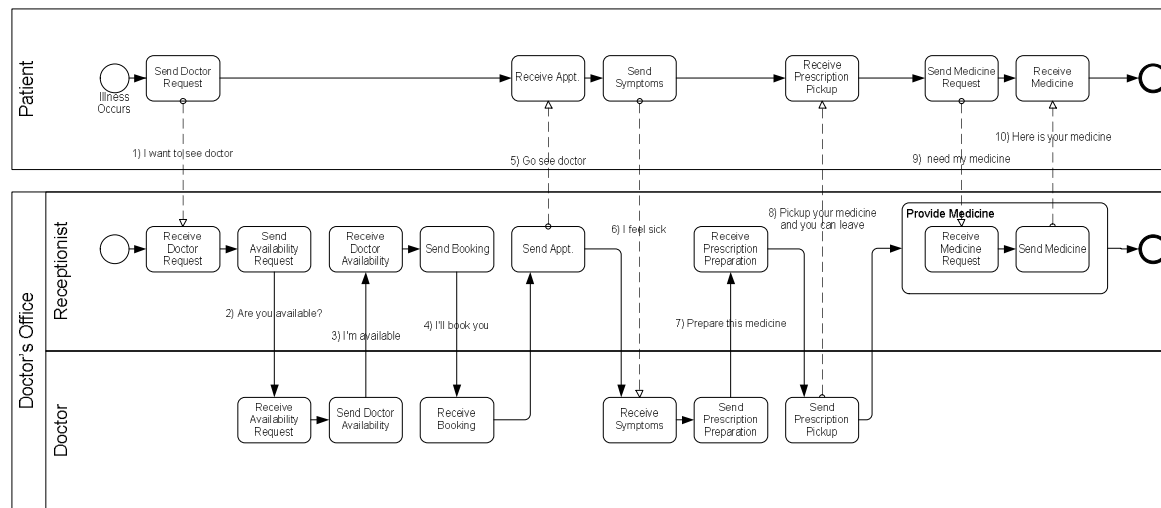

# Pools

- Pools represent Participants in an interactive (B2B) Business Process Diagram
  - ▶ A Participant may be a business role (e.g., “buyer” or “seller”) or may be a business entity (e.g., “IBM” or “OMG”)
- A Pool may be a “black box” or may contain a Process
- Interaction between Pools is handled through Message Flow
- Sequence Flow cannot cross the boundary of a Pool (i.e., a Process is fully contained within a Pool)

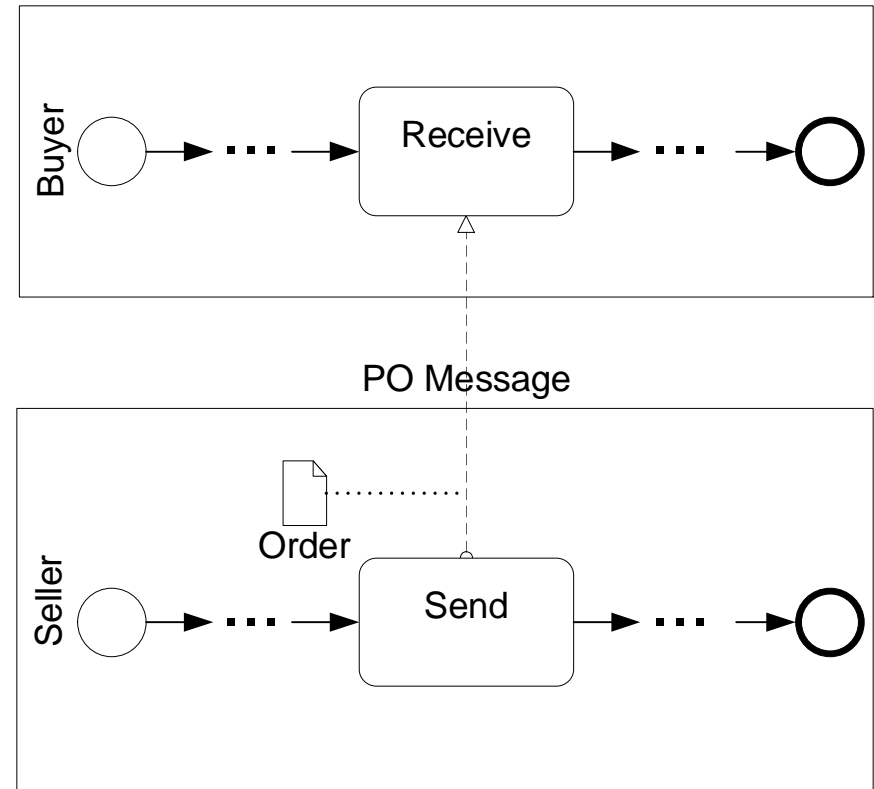

# Lanes

- Lanes represent sub-partitions for the objects within a Pool
- They often represent organization roles (e.g., Manager, Associate), but can represent any desired Process characteristic
- Sequence Flow can cross Lane boundaries

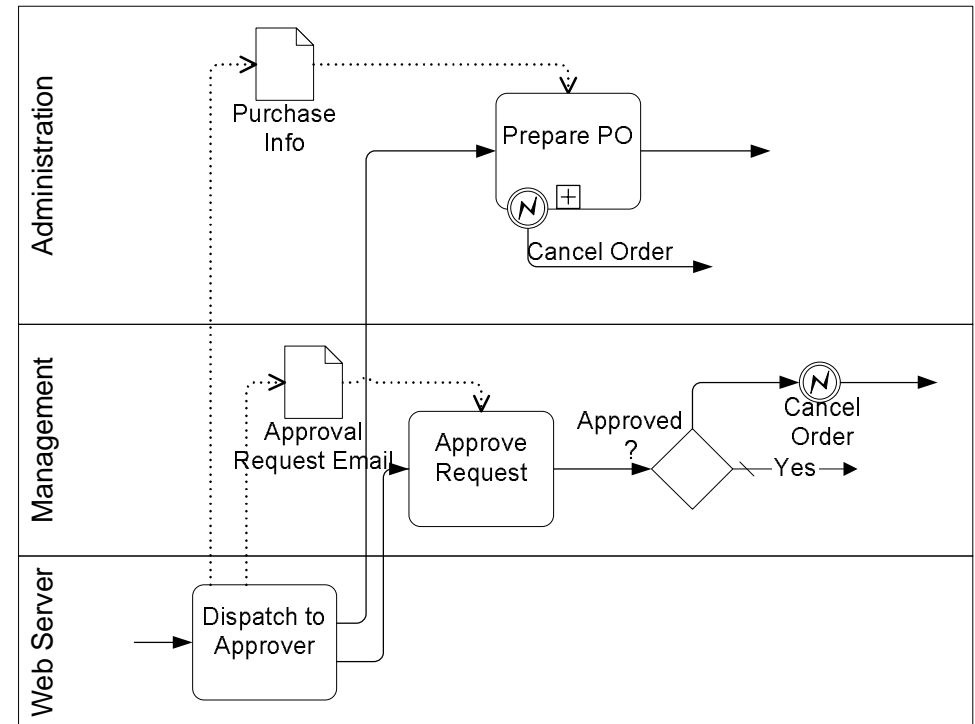

# Artifacts

- Artifacts provide the capability to show information beyond the basic flow-chart structure of the Process
- There are currently three standard Artifacts in BPMN: Data Objects, Groups, and Annotations
  - ▶ Additional Artifacts may be standardized in later version
  - ▶ Sets of vertical market Artifacts may also be developed
- A modeler or tool can extend BPMN by defining new Artifacts



# Text Annotations

- Text Annotations are a mechanism for a modeler to provide additional information about a Process
- Text Annotations can be connected to a specific object on the Diagram with an Association

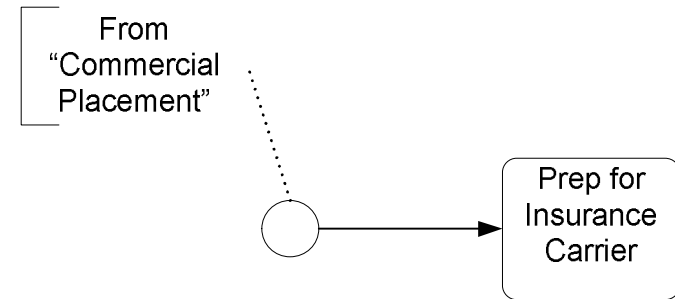

# Data Objects

- Data Objects are Artifacts that are used to show how data and documents are used within a Process
- Data Objects can be used to define inputs and outputs of activities
- Data Objects can be given a “state” that shows how a document may be changed or updated within the Process

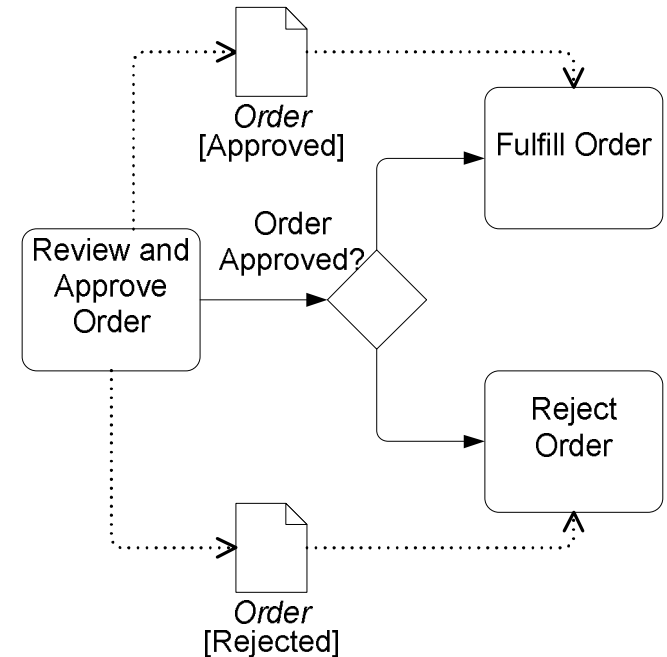

# Groups

- Groups are Artifacts that are used to highlight certain sections of a Diagram without adding additional constraints for performance – as a Sub-Process would
  - ▶ Groups can be used to categorize elements for reporting purposes
- Groups are not constrained by restrictions of Pools and Lanes

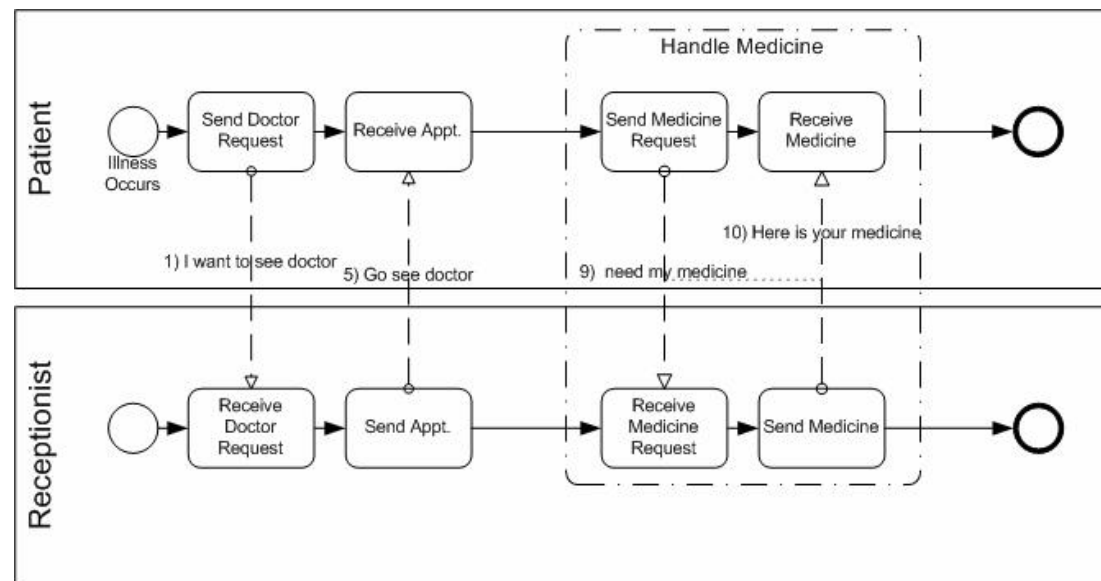



## Artifacts are Extendible

- Modelers and Modeling Tools can add new Artifacts to a diagram
  - ▶ Specific industries or markets may have their own set of Artifacts
- Their shapes must not conflict with existing shapes
- They are not part of normal flow, but can be associated with other elements

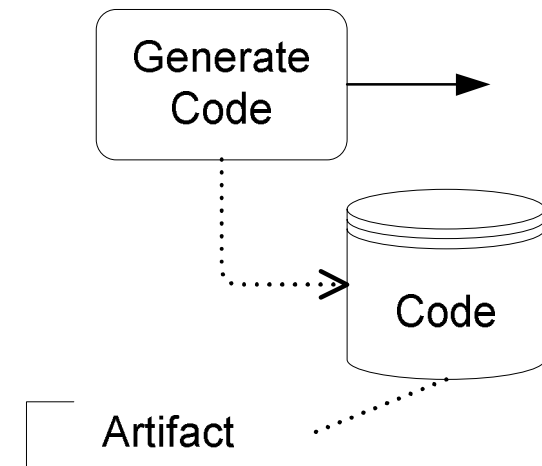

# Topics

- BPMN Background
- Basic Concepts
- **Exercise 1**
- Additional Concepts
- Process Modeling Methodologies
- Orchestration vs. Choreography
- Exercise 2
- Summary



## Exercise 1

- In this exercise you will be given a set of short answer questions that cover the basic BPMN elements
- Some questions will require a written answer and some will require a (simple) drawn answer



## Exercise 1

## Questions: Set 1

- What is the difference between a Task and a Sub-Process?
- Draw a Task with a timeout and the follow-up to the timeout
- What are the main restrictions for Sequence Flow?



## Exercise 1

## Questions: Set 2

- What are the rules for Message Flow connections?
- Draw two ways that data can be output from one Task and then input into another Task
- Why do the different behaviors of the Gateways share the same basic diamond shape?



Exercise 1

## Questions: Set 3

- How can Artifacts be used to enhance the information content of a BPMN diagram?
- Draw a timed delay in a process
- What do Pools represent?



## Exercise 1

## Questions: Set 4

- What's the difference between Exclusive and Inclusive Gateways?
- Draw the synchronization of two parallel paths
- What do Lanes generally represent? And what can they represent?



## Questions: Set 5

- How to Associations affect the main flow of a Process?
- Draw a Message Flow between one “white box” Participant and one “black box” Participant
- What are the rules for adding marker or icons to activities?





## Exercise 1

# Answers: Set 1

- What is the difference between a Task and a Sub-Process?
  - ▶ A Sub-Process can be broken down into a lower level detail (another Process) while a Task cannot
- Draw a Task with a timeout and the follow-up to the timeout
  - ▶ See figure to the right
- What are the main restrictions for Sequence Flow?
  - ▶ A Sequence Flow can only connect Activities, Events, and Gateways, they cannot cross the boundary of a Sub-Process or the boundary of a Pool

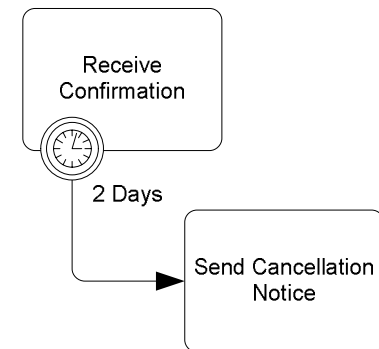

## Exercise 1

## Answers: Set 2

- What are the rules for Message Flow connections?
  - ▶ They must connect from the boundary or object within a Pool to the boundary or object within a *different* Pool
- Draw two ways that data can be output from one Task and then input into another Task
  - ▶ See figures to the right
- Why do the different behaviors of the Gateways share the same basic diamond shape?
  - ▶ Gateways represent a controlling mechanism for Sequence Flow. A diamond in the model shows a place where Sequence Flow control is needed

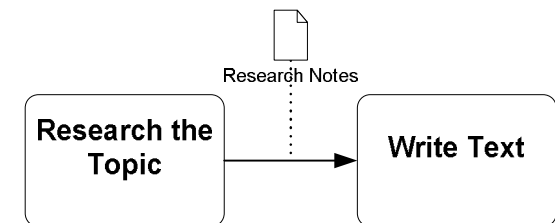
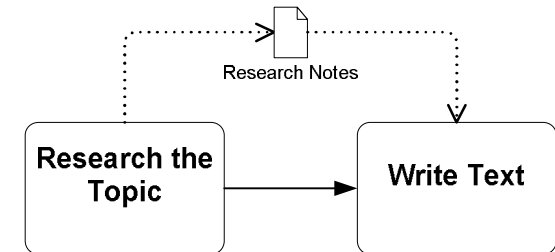

## Exercise 1

# Answers: Set 3

- How can Artifacts be used to enhance the information content of a BPMN diagram?
  - ▶ New Artifacts can be created and added to the diagram to allow visualization of key model factors
- Draw a timed delay in a process
  - ▶ See figure to the right
- What do Pools represent?
  - ▶ Participants in a Process diagram, either a specific entity (e.g., FedEx) or a business role (e.g., Shipper)

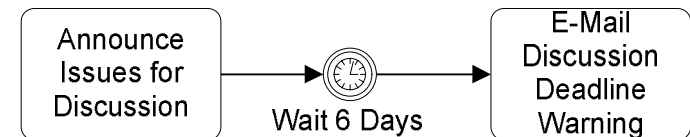

## Exercise 1

# Answers: Set 4

- What's the difference between Exclusive and Inclusive Gateways?
  - ▶ Only one outgoing path is chosen for Exclusive Gateway while at least one to all outgoing paths may be chosen for an Inclusive Gateway
- Draw the synchronization of two parallel paths
  - ▶ See figure to the right
- What do Lanes generally represent? And what can they represent?
  - ▶ The mostly are used to represent organizational roles (e.g., Associate) or departments (e.g., Finance). The can represent most any object attribute that the modeler wants to use to partition activities

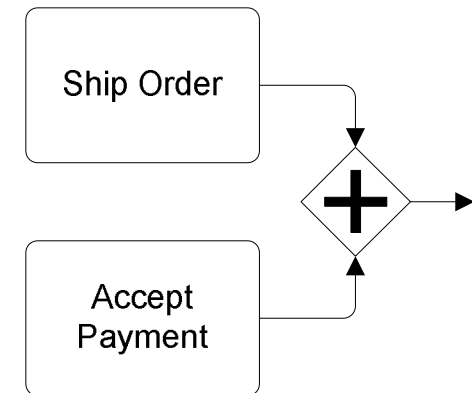

## Exercise 1

# Answers: Set 5

- How to Associations affect the main flow of a Process?
  - ▶ They don't. They can only affect the requirements for an activity
- Draw a Message Flow between one "white box" Participant and one "black box" Participant
  - ▶ See figure to the right
- What are the rules for adding marker or icons to activities?
  - ▶ The marker or icon cannot change the footprint of the activity and cannot conflict with any standard BPMN element

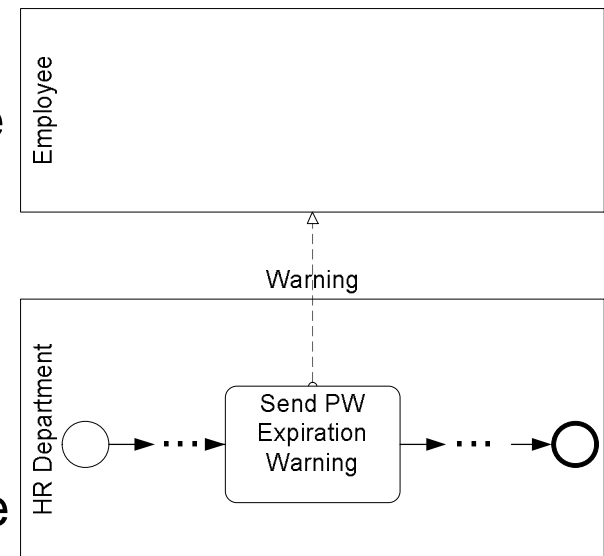

# Topics

- BPMN Background
- Basic Concepts
- Exercise 1
- **Additional Concepts**
- Process Modeling Methodologies
- Orchestration vs. Choreography
- Exercise 2
- Summary



## Normal Flow

- Normal Sequence Flow refers to the flow that originates from a Start Event and continues through activities via alternative and parallel paths until it ends at an End Event
  - ▶ Normal Flow does not include exception flow or compensation flow

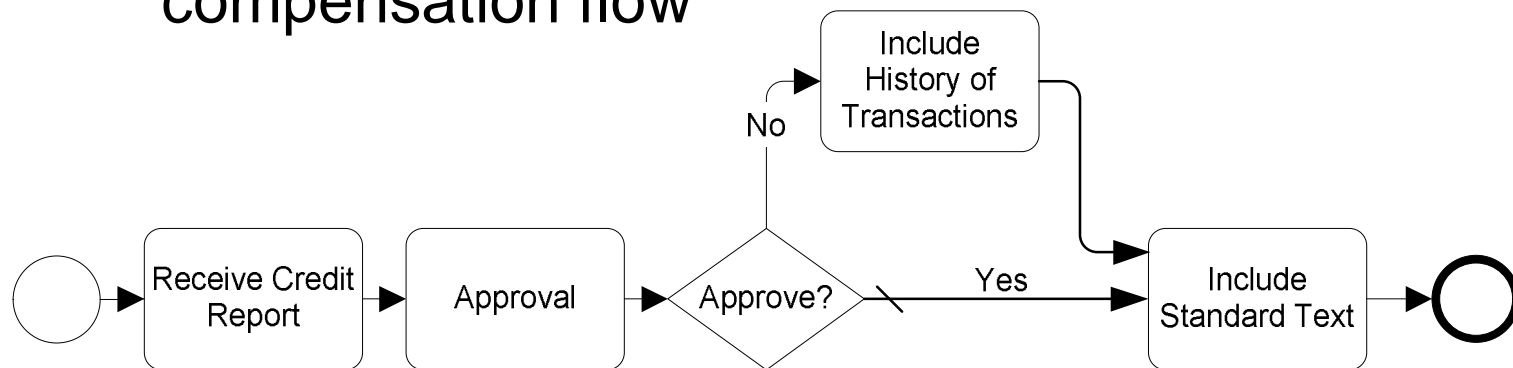

# Link Events Within a Process

- Link Events can be used for Off-Page connectors
- Link Events can be used as “Go-To” objects

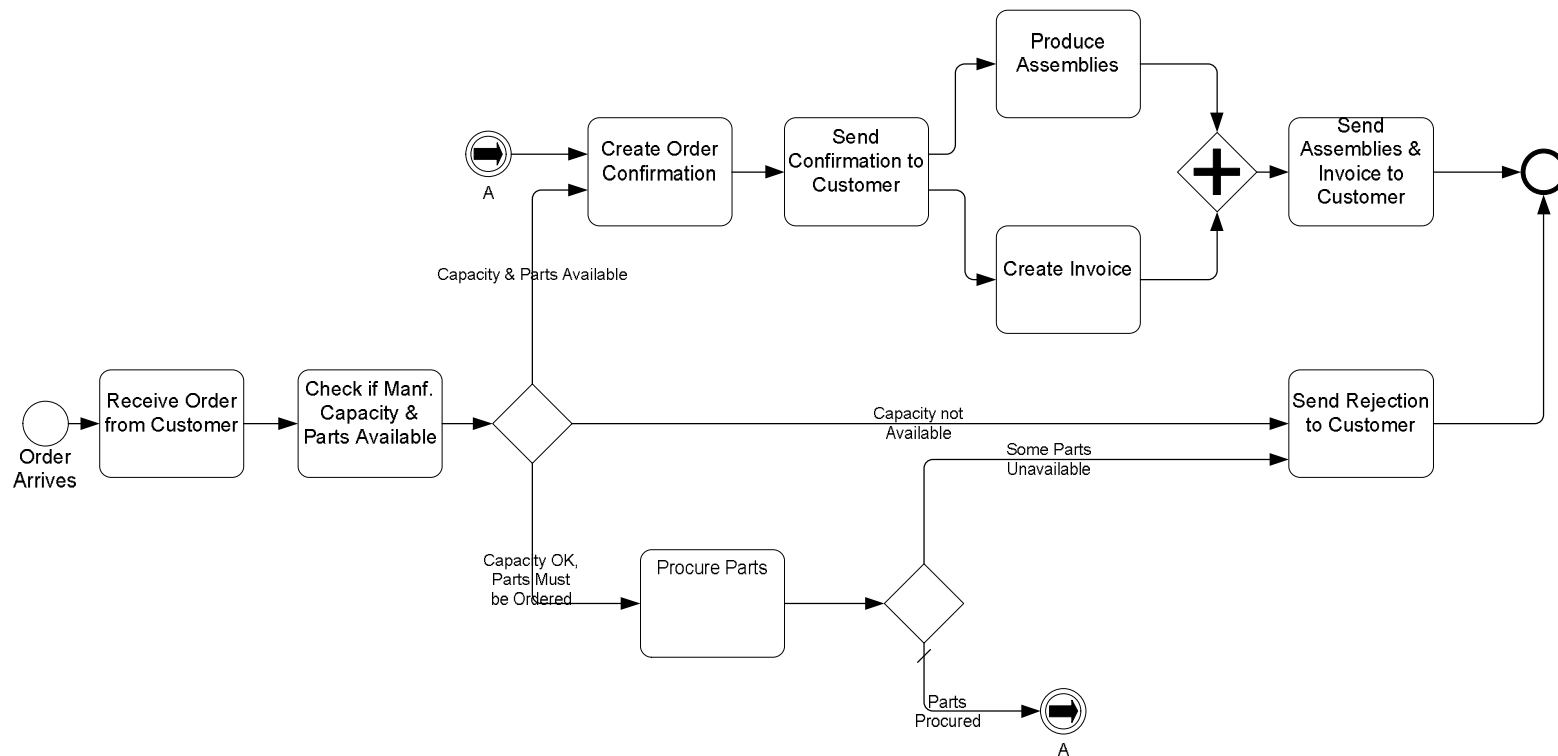



# Process Levels

- Processes can be developed hierarchically, with multiple levels through Sub-Processes
- Sequence Flow cannot cross a Sub-Process boundary
  - ▶ Message Flow and Associations can cross Sub-Process boundaries

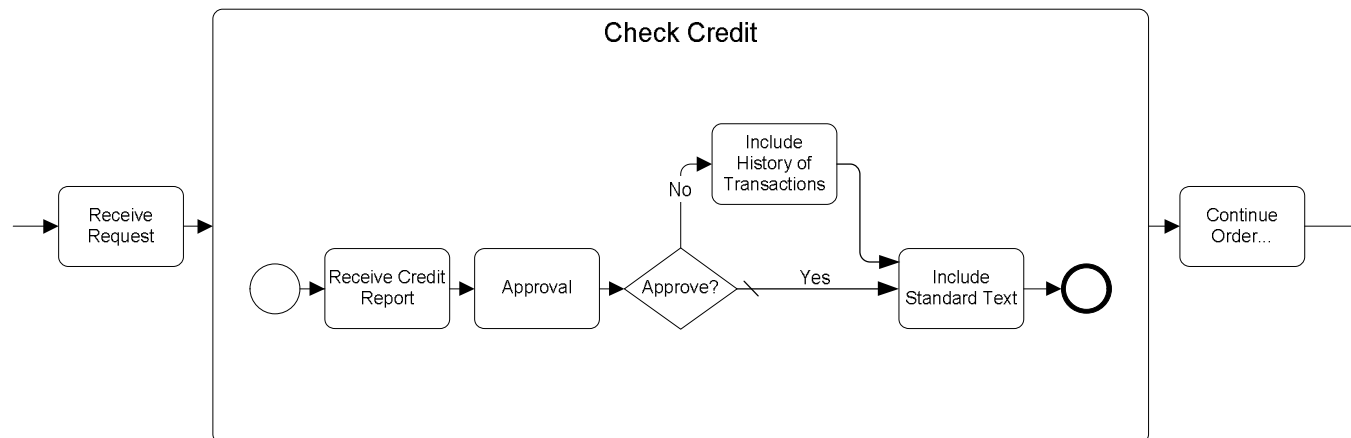

# Data Flow

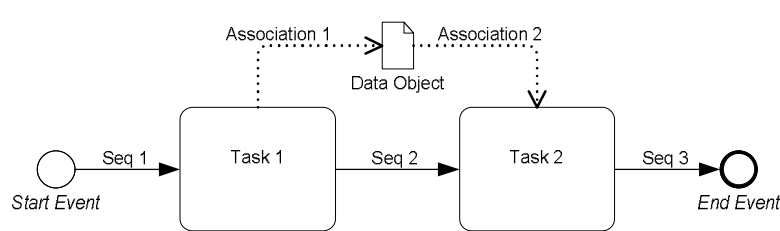

Sequence Flow and Data Flow are decoupled

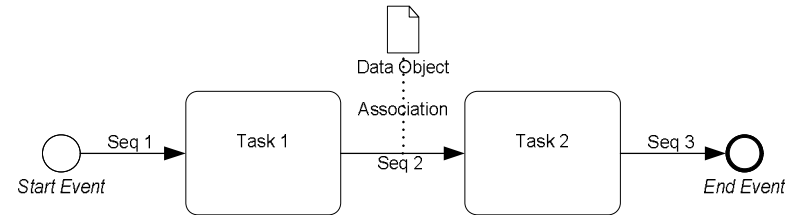

They can be bound together

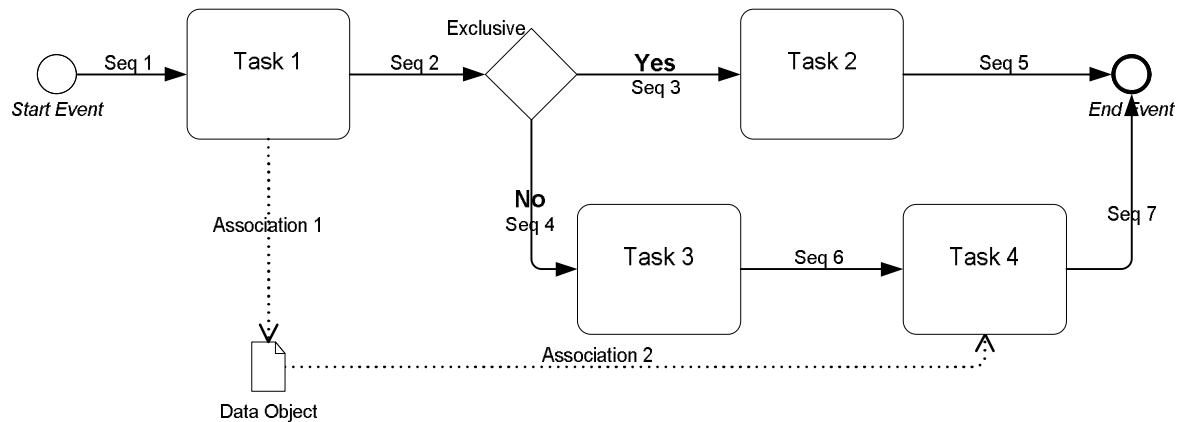

Use case for decoupling



# Exception Handling

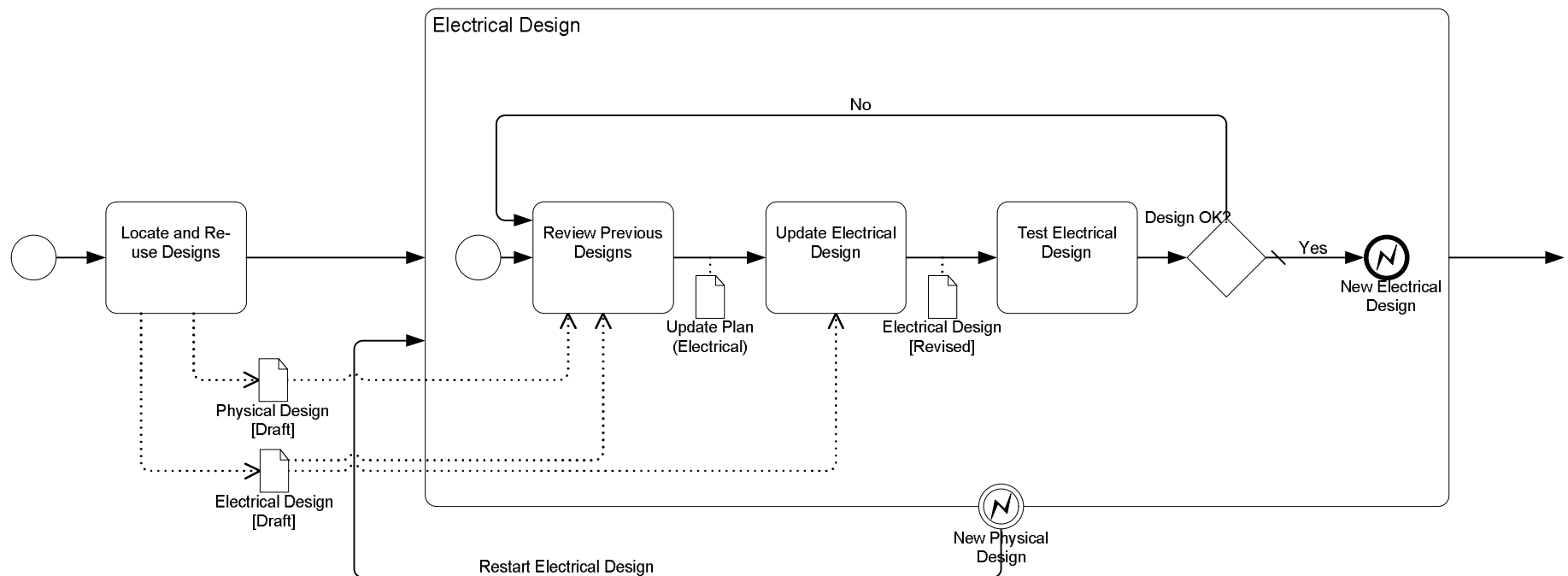

Intermediate Events attached to the boundary of an activity represent triggers that can interrupt the activity. All work within the activity will be stopped and flow will proceed from the Event. Timer, Errors, Messages, etc. can be Triggers.



# Compensation and Transactions

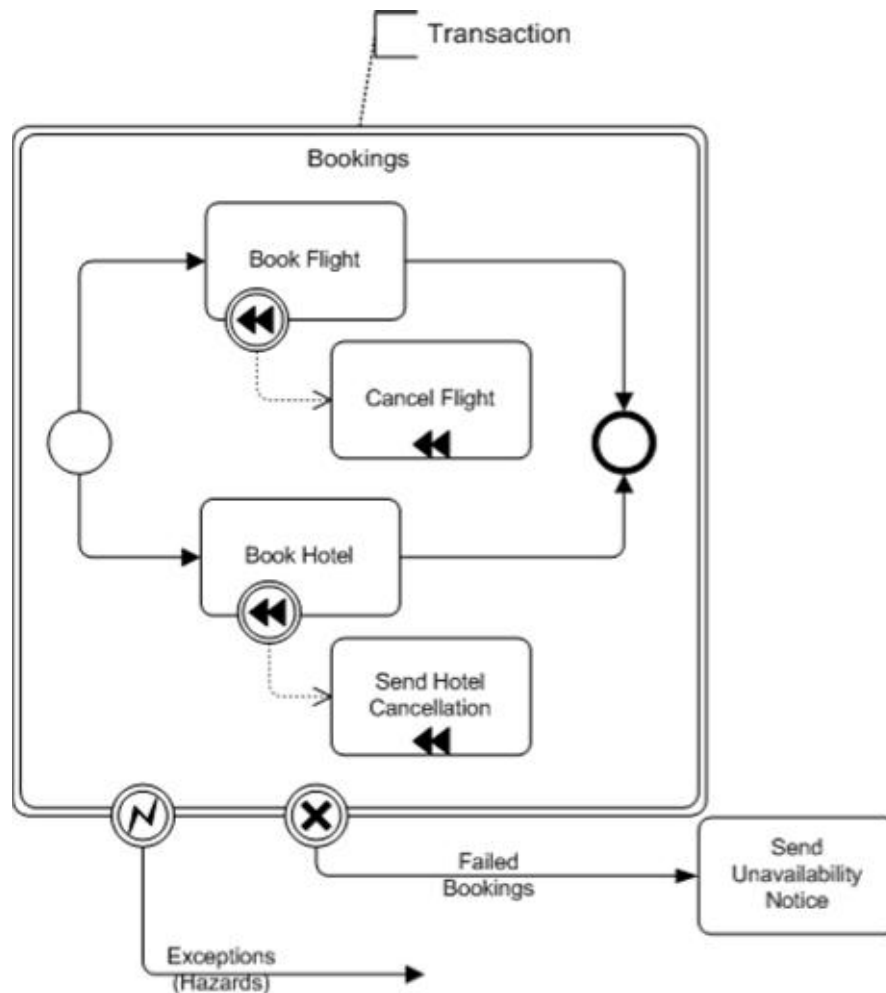

- A Transaction is an activity that has a double border. Transactions are supported by a transaction protocol (e.g., WS-Transaction)
- Normal Outgoing Sequence Flow represents the path to follow a successful completion
- A Cancel Intermediate Event represents the path to follow a cancelled completion
- An Exception Intermediate Event represents the path to follow a transaction hazard (but no compensation is performed)
- Activities used for compensate (with marker) are outside normal flow and are Associated normal activities. Compensation flows “backwards.”



# Looping

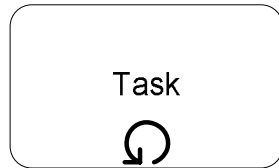

Activity Looping: Do-While;  
While-Do; Multiple Instance

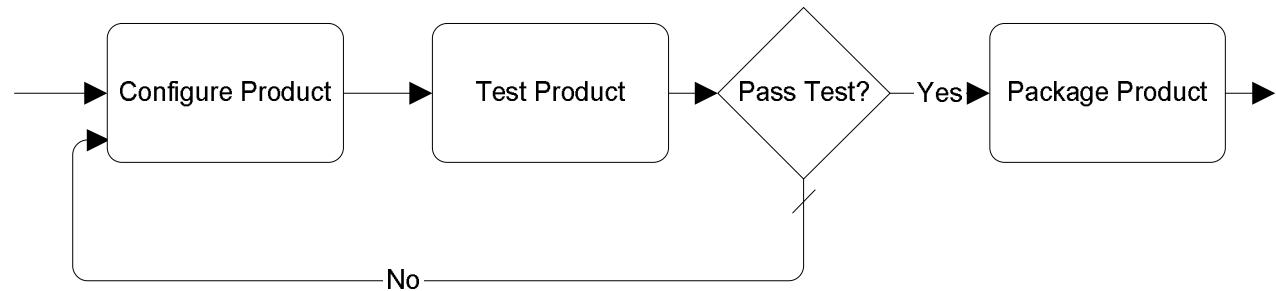

Sequence Flow Looping



# Timers

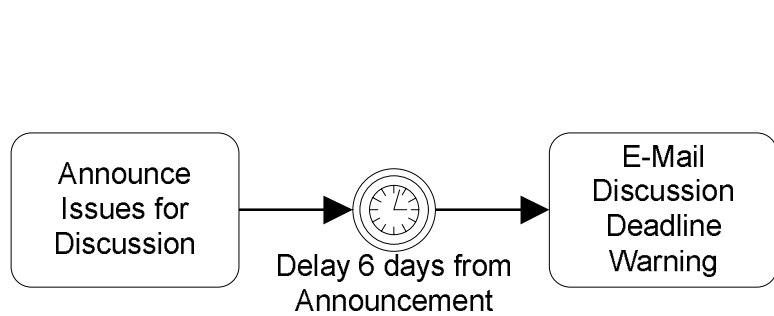

Timers to add delays in the Process

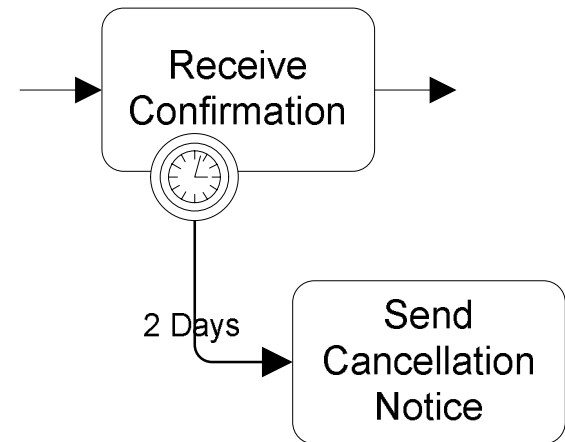

Timeouts for exception handling



# Ad-Hoc Processes

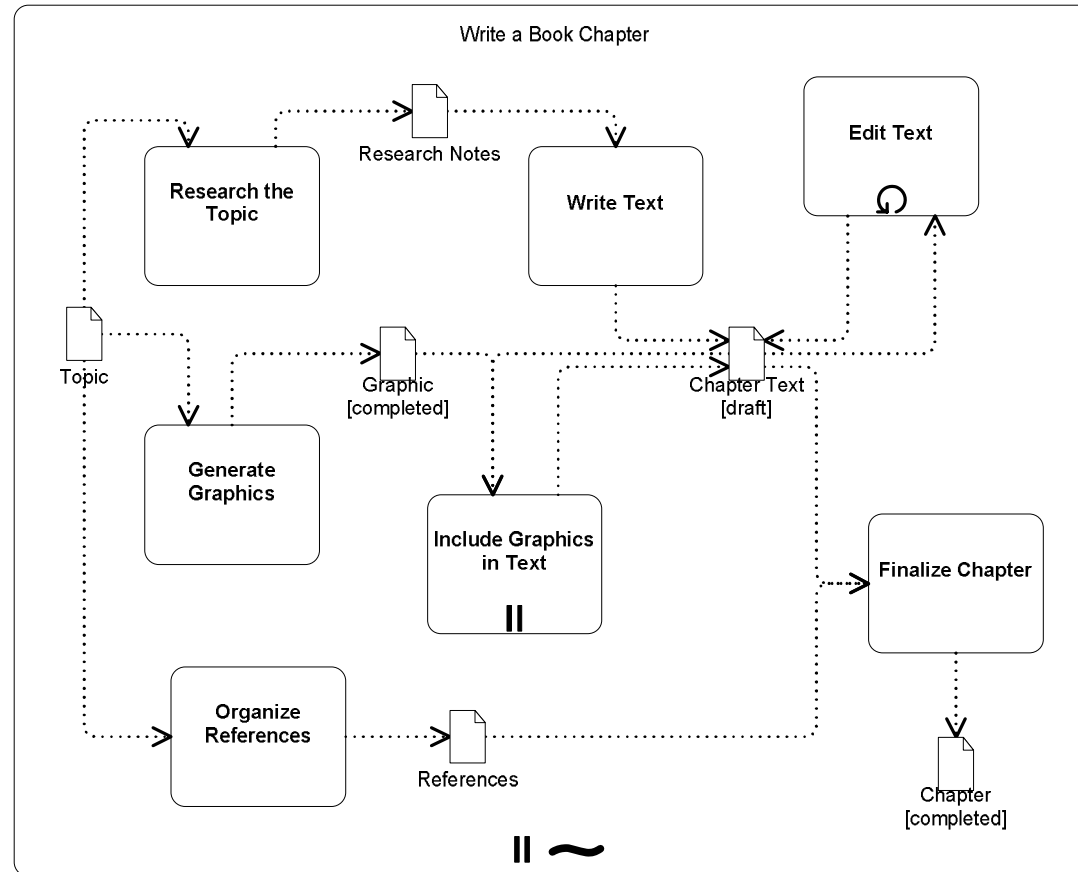

There is no pre-defined Sequence Flow



# Topics

- BPMN Background
- Basic Concepts
- Exercise 1
- Additional Concepts
- **Process Modeling Methodologies**
- Orchestration vs. Choreography
- Exercise 2
- Summary





# Process Modeling Methodologies

- BPMN is intended to be methodology independent
  - ▶ Simple or complex diagrams can be created based on the chosen methodology
  - ▶ Methodologies determine what information is captured about a process
- Many different methodologies can be used for modeling with BPMN
  - ▶ Some may require extended Artifacts
- Examples of methodologies:
  - ▶ LOVeM, EPCs, RAD methodology, IDEF
  - ▶ Consulting organization methodologies



# Example of EPC Modeled in BPMN

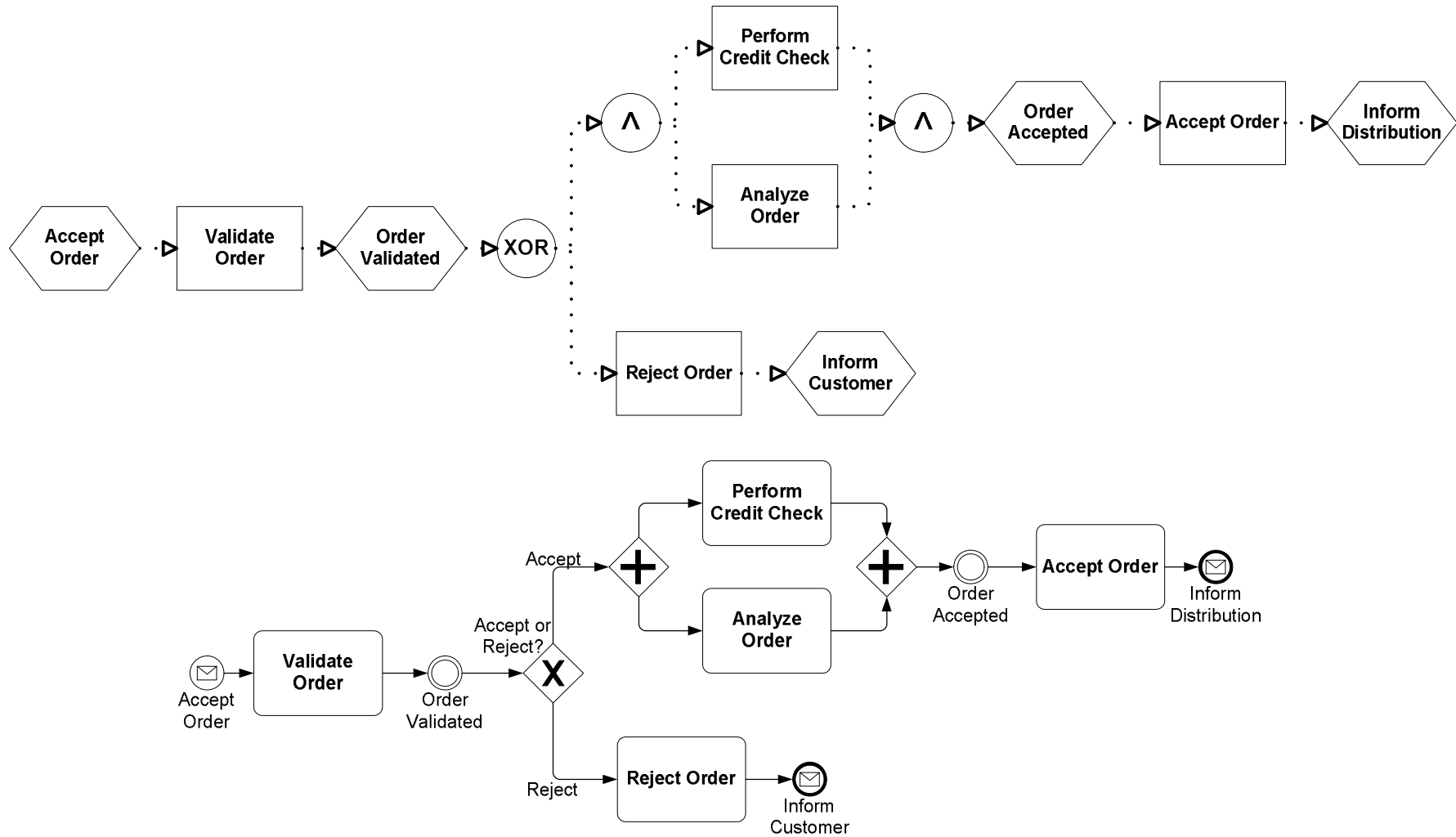

# General Modeling Concepts

- A process is chronological. Accurate models should be oriented on a time line (in general, from left to right in sequence)
- Processes generally begin with triggering events, and work their way through to significant business results
  - ▶ They can also represent smaller segments of re-usable work
- All tasks or activities are assigned to roles that are meaningful to people in the business. Be sure you have captured all relevant roles, which may sometimes be outside of the client's company
- A complete model should display how objects or data (or both) are transferred and where they are going
- A process can be modeled in a hierarchical fashion (e.g., with Sub-Processes)
- The choices made for decisions, which occur within a process, determine which of all potential paths will be taken



# General Modeling Guidelines

- Establish organization standards or guidelines for developing models and naming model elements, e.g.,
  - ▶ Establish naming conventions for each type of modeling object. For example, all activity names could have the following format
    - verb + (adjective/descriptor) + noun
    - example: “Verify Account”
  - ▶ Avoid redundancy in naming, e.g., do not include the word *Process* in the Process names or the words *Task* or *Activity* in Task names
  - ▶ To help with report outputs, names should be 32 characters or less
  - ▶ To help with readability, all words should be capitalized
- Establish a set of standard nouns, verbs, and acronyms that are used for naming objects
- Establish standards for versioning methods associated at the process model and artifact level to provide requirement traceability



# Topics

- BPMN Background
- Basic Concepts
- Exercise 1
- Additional Concepts
- Process Modeling Methodologies
- **Orchestration vs. Choreography**
- Exercise 2
- Summary



## Orchestration vs. Choreography

- Orchestration: Workflow, internal processes, private processes
  - ▶ Contained within one Pool
- Choreography: Collaboration, global processes, B2B processes
  - ▶ Defined by the interaction between Pools



# Orchestration

- Orchestration defines processes that are internal to a specific organization
  - ▶ Thus, they are contained within a single Pool

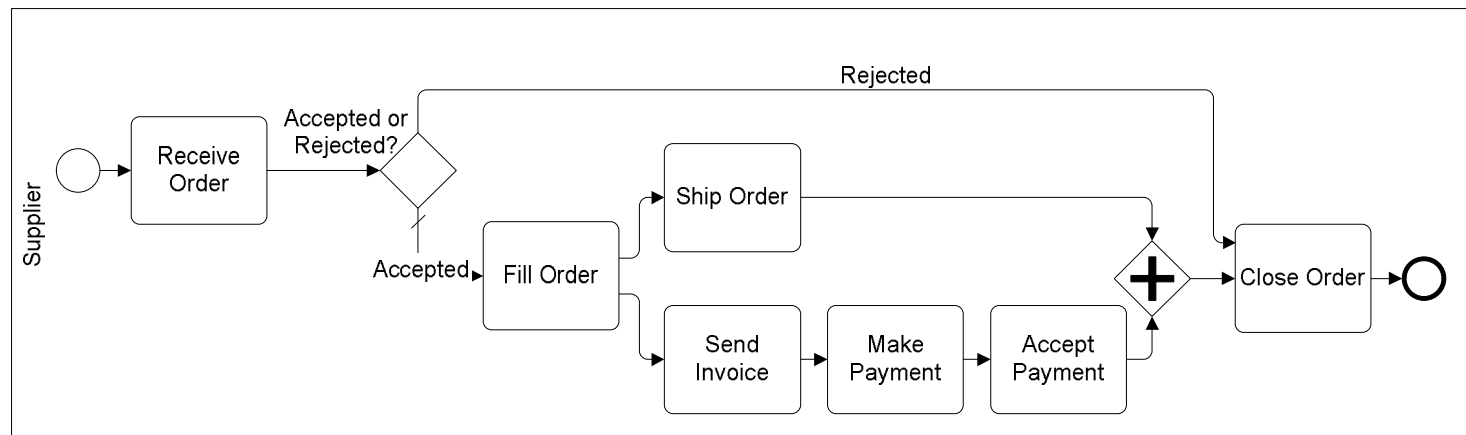

# Choreography

- A Choreography process depicts the interactions between two or more business entities (as modeled with Pools)
  - ▶ Shown by the Message Flow between the Pools
- Or a sequence of interaction (global) types of activities
- BPMN V2.0 will likely update how Choreographies are modeled

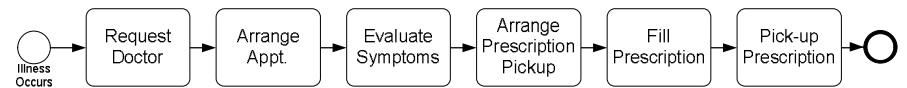
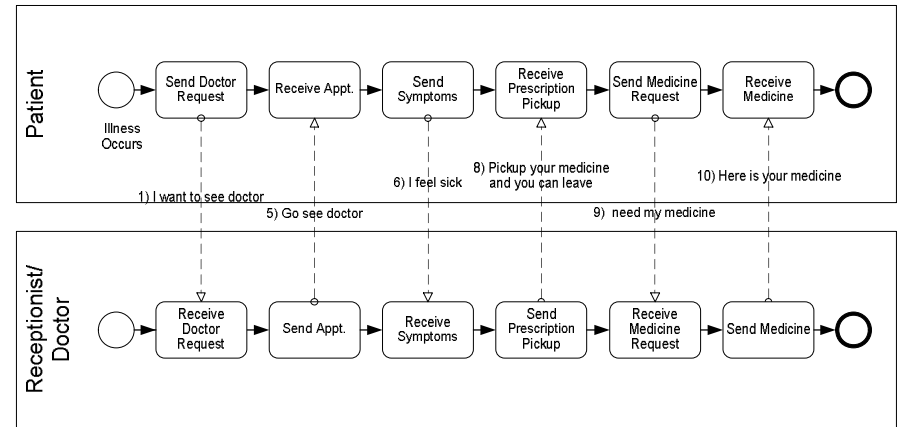



# Topics

- BPMN Background
- Basic Concepts
- Exercise 1
- Additional Concepts
- Process Modeling Methodologies
- Orchestration vs. Choreography
- **Exercise 2**
- Summary



## Exercise 2 – Create a Process for Expense Reimbursement

- In this exercise you will read a text descriptive information about a process and will map the process on paper
- The process is a sample expense reimbursement process:
  - ▶ This process provides for reimbursement of expenses incurred by employees for the company. For example buying a technical book, office supplies or software. In a normal day there are several hundreds of instances of this process created.
- Concentrate on the basic flow of the Process...



## Exercise 2

# Process Information: Expense Reimbursement

- After the Expense Report is received, a new account must be created if the employee does not already have one
- The report is then reviewed for automatic approval
  - ▶ Amounts under \$200 are automatically approved
  - ▶ Amounts equal to or over \$200 require approval of the supervisor
    - In case of rejection, the employee must receive a rejection notice by email
- The reimbursement goes to the employee's direct deposit bank account
- If no action has happened in 7 days, then the employee must receive an approval in progress email
- If the request is not finished within 30 days, then the process is stopped and the employee receives an email cancellation notice and must re-submit the expense report



Exercise 2

# Expense Reimbursement Process

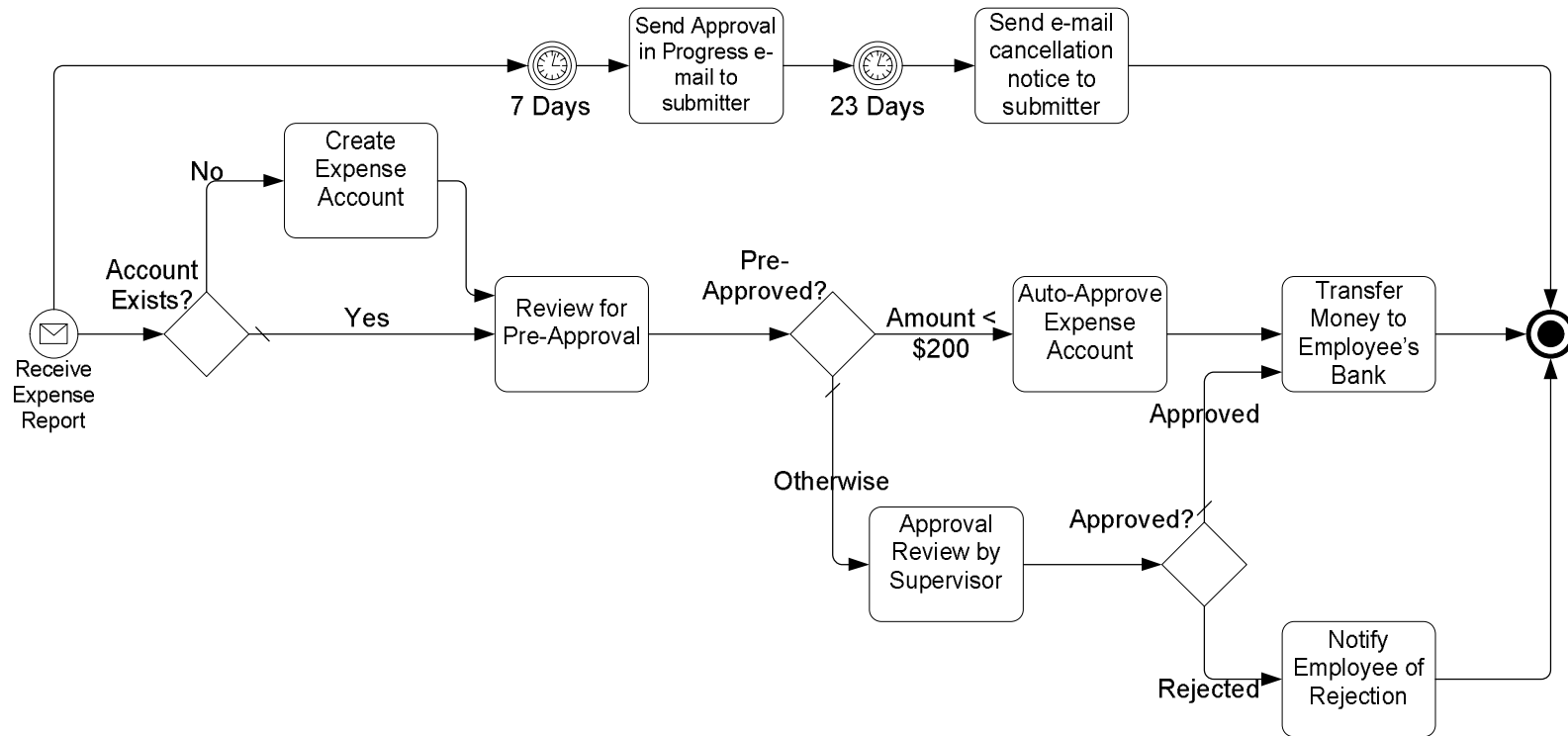

# Topics

- BPMN Background
- Basic Concepts
- Exercise 1
- Additional Concepts
- Process Modeling Methodologies
- Orchestration vs. Choreography
- Exercise 2
- **Summary**



# Summary

- This tutorial covered:
  - ▶ The background of BPMN
  - ▶ Basic BPMN Concepts
  - ▶ Additional BPMN Concepts
  - ▶ Process Modeling Methodologies
  - ▶ Orchestration and Choreography
  - ▶ Two Exercises

